



LANGUE/LANGUAGE • FR/EN

*moving forward in every field*

# VINTAGE

## ▶▶ PIÈCES DE TRACTEURS/TRACTOR PARTS

Catalogue - Première publication 2008

Catalogue - First published 2008

[www.bepcoparts.com](http://www.bepcoparts.com)

Member of **TVH** 

# ■ À PROPOS DE BEPCO

---

Le groupe Bepco est un leader mondial dans la fourniture de pièces de rechange, accessoires pour tracteurs et pièces détachées pour machines agricoles.

Avec plus de 360 employés, le groupe Bepco a des filiales en Belgique, France, Pays-Bas, Allemagne, Espagne et Angleterre. Nous sommes aussi présents en Australie, Nouvelle Zélande, Afrique du sud et au Brésil.

Le groupe Bepco est une société mondiale avec des clients dans plus de 100 pays à travers le monde, les ventes hors Europe contribuent à plus d'un tiers du chiffre d'affaires.

Nous proposons à notre réseau de distributeurs et revendeurs :

- ▶ Des fournisseurs d'équipements d'origine et d'autres marques reconnues
- ▶ Plus de 20 000 m<sup>2</sup> de surface de stockage
- ▶ Plus de 80 000 références en stock
- ▶ Des connaissances techniques d'experts de l'industrie
- ▶ Une expédition le jour même pour une livraison le jour suivant

Le groupe Bepco fait partie du groupe TVH, fournisseur de pièces et accessoires de qualité pour le matériel de manutention, les véhicules industriels et l'équipement agricole.

# ■ ABOUT BEPCO

---

Bepco Group is a worldwide leading supplier of parts and accessories for agricultural tractors and machinery.

With over 360 employees Bepco Group has subsidiaries in Belgium, Netherlands, France, Germany, Spain and UK and is also present in Australia, New Zealand, South Africa and Brazil.

Bepco Group is a truly global company with customers in over 100 countries worldwide and sales outside Europe contributing to over a third of revenues.

We offer our network of distributors and dealers :

- ▶▶ Original Equipment Supplier and other industry leading brands
- ▶▶ More than 20,000 m<sup>2</sup> of warehousing
- ▶▶ More than 80,000 stock items
- ▶▶ Technological knowledge from industry experts
- ▶▶ Same day shipment, next day delivery in many markets

Bepco Group is also a member of TVH, the all-round supplier of quality parts and accessories for material handling, industrial vehicles and agricultural equipment.

**GARDE-BOUES**  
**FENDERS**



<b>Tractors</b> <i>Tractores</i>	<b>Fig.</b> <i>Fig.</i>	<b>Ref.</b> <i>Ref.</i>	<b>OEM</b>	<b>Description</b> <i>Description</i>
770, 780, 885	1	<b>20/844-34</b>	K921561, K921560	Gauche / Droit Left / Right
850, 880	2	<b>20/844-35</b>	K904274, K904725	
990 Implematic	3	<b>20/844-96</b>	K913205, K913209	

## GARDE-BOUES FENDERS



Tractors Tractores	Fig. Fig.	Ref. Ref.	OEM	Description Description
Farmall / Mc Cormick B-450	1	25/844-36 LH		Gauche / LH
		25/844-36 RH		Droit / RH
Mc Cormick DED3, DGD4, D320, D326, D430, D439	2	25/844-38 LH		Gauche / LH
		25/844-38 RH		Droit / RH
Mc Cormick 323, 353, 423, 453	3	25/844-40 LH		Gauche / LH
		25/844-40 RH		Droit / RH
Mc Cormick 523, 624, 724, 824	3	25/844-41 LH		Gauche / LH
		25/844-41 RH		Droit / RH
743XL, 745XL, 844XL, 845XL, 856XL, 3210, 3220, 3230, 4210, 4220, 4230, 4240	4	25/844-43 LH	3234659R1	Gauche / LH
		25/844-43 RH	3405809R1	Droit / RH
955XL, 956XL, 1055XL, 1056XL, 1255XL, 1455XL	5	25/844-44 LH	3234651R1	Gauche / LH
		25/844-44 RH	3405810R1	Droit / RH
5120, 5130, 5140, 5150	6	25/844-45 LH	1958612C2	Gauche / LH
		25/844-45 RH	1958611C4	Droit / RH

## EMBLEMES EMBLEMS



Tractors Tractores	Fig. Fig.	Ref. Ref.	OEM
Ancienne gamme / Old range	1	25/863-15	
248, 258, 385, 433, 485, 485XL, 533, 585, 585XL, 633, 685, 685XL, 733, 743, 743XL, 745S, 745XL, 785, 785XL, 833, 844S, 844XL, 845, 845XL, 856XL, 885, 885XL, 956, 956XL, 1056, 1056XL, 1255, 1255XL, 1455, 1455XL, 9110, 9130, 9210, 9230	2	25/863-16	1333266C1, 1536056C1, A181523, A181437

## CALANDRES FRONT GRILLS

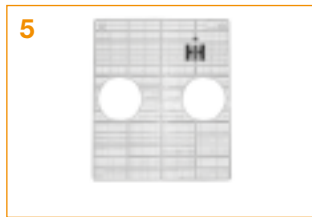
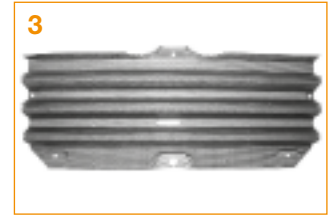

Tractors Tractores	Fig. Fig.	Ref. Ref.	OEM	Description Description
323, 353, 383, 423, 453	1	25/841-16	786862R2	Calandre en plastique Plastic grill
433, 433E, 433V, 533, 533E, 533V, 633, 633E, 633V, 733, 733E, 833, 833E	2	25/841-22	85643C2	
	3	25/841-23	85644C1, 85644C2	Grille supérieure Upper grill
	4	25/841-24	85645C1, 85645C2	Grille inférieure Lower grill
523, 624, 724, 824	5	25/841-17	3057444R2	Calandre en métal Iron grill
644, 743, 743XL, 744, 745S, 745XL, 844, 844S, 844XL, 856XL, 946, 955, 955XL, 956, 956XL, 1046, 1055, 1055XL, 1056, 1056XL, 1246 (International)	6	25/841-18	3402639R91, 3141013R91	Calandre supérieure en plastique Upper plastic grill
		25/841-18 E		Calandre sup. en plast. - Version économique Upper plastic grill - Economic version
	7	25/841-19	3141785R91, 3141785R92	Calandre inférieure en plastique Lower plastic grill
743, 743XL, 745S, 745XL, 844S, 844XL, 845, 845XL, 856XL, 956, 956XL, 1056, 1056XL (Case IH)	8	25/841-20	85639C1	Calandre supérieure en plastique Upper plastic grill
	9	25/841-21	85640C2	Calandre inférieure en plastique Lower plastic grill

## DECALCOMANIES DECAL SETS

Tractors Tractores	Ref. Ref.	Description Description
323	25/860-323	
353	25/860-353	
383	25/860-383	
423	25/860-423	
453	25/860-453	
523	25/860-523	
624	25/860-624	
724	25/860-724	
824	25/860-824	
433	25/860-230 *	
533	25/860-231 *	International 533 G & D / <i>International 533 LH &amp; RH</i>
633	25/860-232 *	International 633 G & D / <i>International 633 LH &amp; RH</i>
733	25/860-233 *	International 733 G & D / <i>International 733 LH &amp; RH</i>
833	25/860-234 *	International 833 G & D / <i>International 833 LH &amp; RH</i>
844XL	25/860-235 *	International 844XL G & D / <i>International 844XL LH &amp; RH</i>
433	25/860-236 *	Case International 433 G & D + 433 x 2 / <i>Case International 433 LH &amp; RH + 833 x 2</i>
533	25/860-237 *	Case International 533 G & D + 533 x 2 / <i>Case International 533 LH &amp; RH + 533 x 2</i>
633	25/860-238 *	Case International 633 G & D + 633 x 2 / <i>Case International 633 LH &amp; RH + 633 x 2</i>
733	25/860-239 *	Case International 733 G & D + 733 x 2 / <i>Case International 733 LH &amp; RH + 733 x 2</i>
833	25/860-240 *	Case International 833 G & D + 833 x 2 / <i>Case International 833 LH &amp; RH + 833 x 2</i>
644	25/860-300 *	International 644 G & D + 644 x 2 / <i>International 644 LH &amp; RH + 644 x 2</i>
744	25/860-301 *	International 744 G & D + 744 x 2 / <i>International 744 LH &amp; RH + 744 x 2</i>
844	25/860-302 *	International 844 G & D + 844 x 2 / <i>International 844 LH &amp; RH + 844 x 2</i>
844S	25/860-303 *	International 844S G & D + 844 x 2 / <i>International 844S LH &amp; RH + 844 x 2</i>
844SB	25/860-304 *	International 844SB G & D + 844 x 2 / <i>International 844SB LH &amp; RH + 844 x 2</i>
844S	25/860-305 *	Case International G & D + 844S x 2 / <i>Case International LH &amp; RH + 844S x 2</i>
743XL	25/860-306 *	Case International G & D + 743XL G & D / <i>Case International LH &amp; RH + 743XL LH &amp; RH</i>
745XL	25/860-307 *	Case International G & D + 745XL G & D / <i>Case International LH &amp; RH + 745XL LH &amp; RH</i>
844XL	25/860-308 *	Case International G & D + 844XL G & D / <i>Case International LH &amp; RH + 844XL LH &amp; RH</i>
845XL	25/860-309 *	Case International G & D + 845XL G & D / <i>Case International LH &amp; RH + 845XL LH &amp; RH</i>
955	25/860-310 *	International 955 G & D / <i>International 955 LH+RH</i>
955XL	25/860-311 *	International 955XL G & D + portières LH & RH / <i>International 955 LH &amp; RH + door LH &amp; RH</i>
1055	25/860-312 *	International 1055 G & D / <i>International 1055 LH &amp; RH</i>
1055XL	25/860-314 *	International 1055XL G & D + portières LH & RH / <i>International 1055 LH &amp; RH + door LH &amp; RH</i>
1255	25/860-315 *	International G & D + 1255 x 2 / <i>International LH &amp; RH + 1255 x 2</i>
1255XL	25/860-316 *	International G & D + 1255XL G & D / <i>International LH &amp; RH + 1255XL LH &amp; RH</i>
1455	25/860-317 *	International G & D + 1255 x 2 / <i>International LH &amp; RH + 1255 x 2</i>
1455XL	25/860-318 *	International G & D + 1455XL G & D / <i>International LH &amp; RH + 1455XL LH &amp; RH</i>
1255	25/860-319 *	Case International G & D + 1255 x 2 / <i>Case International LH &amp; RH + 1255 x 2</i>
1255XL	25/860-320 *	Case International G & D + 1255XL G & D / <i>Case International LH &amp; RH + 1255XL LH &amp; RH</i>
1455	25/860-321 *	Case International G & D + 1255 x 2 / <i>Case International LH &amp; RH + 1255 x 2</i>
1455XL	25/860-322 *	Case International G & D + 1455XL G & D / <i>Case International LH &amp; RH + 1455XL LH &amp; RH</i>



## CALANDRES FRONT GRILLS



Tractors Tractores	Fig. Fig.	Ref. Ref.	OEM	Description Description
Fordson Dexta	1	24/838-5	957E8202A	
Fordson Major	2	24/838-6	E1ADDN8203A	
Super Dexta	3	24/838-7	E1ADKN8164A	
5000	4	24/838-8	D0NN8N202K	Sans trou / Without hole
3000, 4000	5	24/838-9	D4NN8N2020	Sans trou / Without hole
2000, 3000, 4000, 4100, 5000, 7000	6	24/840-9	81823928, C9NN8A163AG	
Major	7	24/840-15		Grille sans trou / Grill without light hole
Dexta	8	24/840-16		Grille sans trou / Grill without light hole

## COLLECTEUR ET JOINT D'ÉCHAPPEMENT MANIFOLD AND GASKET EXHAUST

Tractors Tractores	Fig. Fig.	Ref. Ref.	OEM	Description Description
Fordson Dexta Fordson Super Dexta	1	24/65-32	957E9430A	Collecteur d'échappement Manifold exhaust
	2	24/66-32	957E9448	Joint du collecteur d'échapp. Gasket manifold exhaust





## CALANDRES FRONT GRILLS

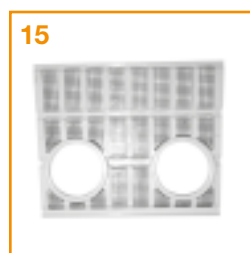
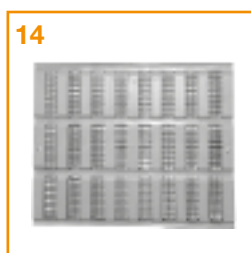

Tractors Tractores	Fig. Fig.	Ref. Ref.	OEM	Description Description
Major	9	24/840-17		Grille avec trou / Grill with light hole
Dexta	10	24/840-18		Grille avec trou / Grill with light hole
8N	11	24/840-19		
2600, 3600, 3900, 4100, 4600, 5600, 6600, 7600	12	24/841-11	83905164, 83905164	
	13	24/841-12	83905165, D5NN8200A	
2000, 3000, 4000, 4100, 5000, 7000	14	24/841-13	81824197, D1NN8151A	
2000, 3000, 4000, 5000, 7000	15	24/841-15	81824198, D1NN8151B	

## EMBLEMES EMBLEMS

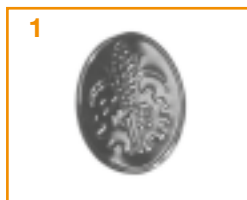

Tractors Tractores	Fig. Fig.	Ref. Ref.	OEM	Description Description
Major, Dexta	1	24/868-2	E1ADKN8212C	
Super Major	2	24/868-3	E1ADDN8212B	Aluminium
Fordson, Power Major	3	24/868-4	E1ADDN16605E	

**GARDE-BOUES**  
**FENDERS**



Tractors Tractores	Fig. Fig.	Ref. Ref.	OEM	Description Description
Dexta	1	24/844-18 (D / RH)	957E16312B	Avec armature With bracket
		24/844-21 (G / LH)	957E16313D	
Super dexta, 3000	8	24/844-94 (D / RH)	957E16312A	
		24/844-95 (G / LH)	957E16313C	
Super Major	2	24/844-19 (G / LH)	E1ADDN16313E	
		24/844-20 (D / RH)	E1ADDN16312B	
Major, Power major	3	24/844-63 (G / LH)	E1ADKN16313B	Premier Major Early Major
		24/844-62 (D / RH)	E1ADKN16312B	
2000, 2600, 2610, 3000, 3610, 4000, 4500	4	24/844-24 (G / LH) (D / RH)	89932110 E1NN16315DA	Revêtement seulement avec support D ou G Skin only with bracket RH or LH
	5	24/844-25 (G / LH) (D / RH)	81816643 C5NN16312AK C5NN16312AU	Revêtement seulement D ou G Skin only RH or LH
3000	6	24/844-88 (D / RH)	C5NN16312A	
		24/844-89 (G / LH)	C5NN16312K	
4000, 5000	7	24/844-90 (D / RH)		
		24/844-91 (G / LH)		

## GARDE-BOUES FENDERS



Tractors Tractores	Fig. Fig.	Ref. Ref.	OEM	Description Description
2000, 3000 (Sans cabine et sans sécurité / Less cab and less safety fender)	1	24/844-97	D1NN16312F	Droit / Right
		24/844-98	D1NN16313B	Gauche / Left
3600, 3610	2	24/844-99	82NT16N392AB	Droit / Right
		24/844-100	82NT16N393AB	Gauche / Left
	3	24/844-101	D3NN16N319A	Support de garde-boue Support fender
5000 (Sans cabine / Less cabine)	4	24/844-102	C9NN16312E	Droit / Right
		24/844-103	D0NN16313R	Gauche / Left
6600, 6610	5	24/844-104	E4NN16312EA	Droit / Right
		24/844-105	D3NN16313PB	Gauche / Left

## PANNEAUX PANELS



Tractors Tractores	Fig. Fig.	Ref. Ref.	OEM	Description Description
Dexta (Standard)	1	24/844-93	957E16312A	
Major	2	24/844-92	957E16313C	

## BOÎTES A OUTILS TOOLS BOXES



Tractors Tractores	Fig. Fig.	Ref. Ref.	Description Description
Dexta	1	24/1563-1	280x100x100mm Modèle adaptable / <i>Adaptable model</i>
Major	2	24/1563-2	420x115x112mm Modèle original / <i>Original model</i>

## FEUX DE POSITION FRONT LIGHTS SIDE

Tractors Tractores	Ref. Ref.	Description Description
Dexta, Super Dexta	24/1918-114	Droit (Garde-boue ronds) <i>RH (Round fenders)</i>
	24/1918-115	Gauche (Garde-boue ronds) <i>LH (Round fenders)</i>



## MARCHE-PIEDS FOOTSTEPS



Tractors Tractores	Fig. Fig.	Ref. Ref.	OEM	Description Description
4000	1	24/855-1	D3NN16473F	Droit / RH
	2	24/855-2	C7NN16450C	Gauche / LH

## JANTES AVANT 2 RM FRONT WHEELS 2 RM

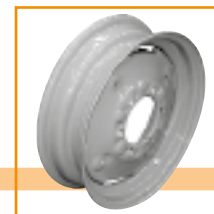

Tractors Tractores	ROUE AVANT FRONT WHEEL			
Dimension de la jante / Wheel size	4.50 x 16"	4.50 x 19"	5.50 x 16"	5.50 x 18"
Dimension du pneu / Tyre size	6.00 x 16"	6.00 x 19"	7.50 x 16"	7.50 x 18"
Major, Super Major			24/449-6 E6NN1007BA, 83960327, 82005056	
Dexta, Super Dexta	24/449-5 957E1015D, 81802273			
2000, 2310, 2600, 2810, 2910, 3000, 3230, 3430, 3600, 3610, 3910, 3930, 4000, 4100, 4110, 4130		24/449-15 E6NN1007DA, 83960325, 82005058		
4600, 4610, 4630, 5000, 5030, 5110, 5600, 5610, 5610S, 5640, 5700, 5900, 6410, 6600, 6610, 6610S, 6640, 6700, 6710, 6810, 6810S, 7000, 7410, 7600, 7610, 7610S, 7710, 7740, 7810, 7810S, 7840, 7910, 8000, 8210, 8600, 8700, 9000, 9200, 9600, 9700			24/449-6 E6NN1007BA, 83960327, 82005056	24/449-7 E6NN1007CA, 83960329, 82005057

**VITRERIE DE CABINE**  
**CAB GLASS**



**LAMBOURN FORD Q CAB**

Tractors Tractores	Ref. Ref.	OEM	Pos.	Description Description	Dimensions Dimensions
INDUSTRIAL 233, 333 2600, 3600, 4100, 4600	24/4000-31	D6458 (1)	A		1204 x 628 x 5
	24/4000-32	D6398 (2)			1214 x 664 x 5
	24/4011-7A	D6457	B	G - LH	584 x 219 x 5
	24/4010-10	D6463		D - RH	584 x 219 x 5
	24/4013-2	D6518		Avec chauffage With heater fitted	314 x 194 x 5
	24/4022-16	D6460		C	584 x 565 x 5
	24/4021-23	D6459 (3)	D	G/D - L&R	554 x 418 x 5
	24/4021-15	D6465 (4)			462 x 414 x 5
	24/4047-1	D6461	E	G/D - L&R / 6H	712 x 688 x 5
	24/4072-12	D6462 (1)	F	Bord arrondi All coners radius	1100 x 534 x 5
	24/4072-13	D6548 (2)		Bord carré Square at bottom	1240 x 600 x 5
	24/4073-109	D6421 (1)	G		586 x 176 x 5
	24/4073-10	D6399 (2)			842 x 176 x 5

A = Pare-brise / Windscreen  
 B = Avant bas / Lower front  
 C = Haut porte / Top door  
 D = Bas porte / Lower door  
 E = Latérale / Side  
 F = Arrière haut / Upper rear  
 G = Arrière bas / Lower rear  
 6H = 6 Trous / 6 Holes  
 L = Gauche / Left  
 R = Droite / Right  
 CL = Claire / Clear

(1) A partir de / Up to cab s/n LQC 764 / 1299 & LQC 771 / 2599

(2) Jusque / From cab s/n LQC 764 / 1300, LQC 771 / 2600 aussi / also 4WD LQC 802 / 001 & LQC 803 / 001

(3) 2600, 3600, 233 & 333 Seulement / Only

(4) 4100 & 4600 Seulement / Only



## VITRERIE DE CABINE CAB GLASS



### LAMBOURN FORD Q CAB

Tractors Tractores	Ref. Ref.	OEM	Pos.	Description Description	Dimensions Dimensions	
INDUSTRIAL 234, 334 2610, 3610, 4110, 4610	24/4000-33	D6582	A	G/D - L&R	1241 x 690 x 5	
	24/4012-66	D6507 (1)	B		621 x 250 x 5	
	24/4013-4	D6508 (2)			310 x 223 x 5	
	24/4012-20	D6509 (3)	606 x 251 x 5			
	24/4013-3	D6510 (4)	296 x 222 x 5			
	24/4022-17	D6583	C		691 x 672 x 5	
	24/4021-17	D6584 (1)	D		847 x 557 x 5	
	24/4021-16	D6585			813 x 570 x 5	
	24/4047-1	D6461	E		G/D - L&R / 6H	712 x 688 x 5
	24/4072-13	D6548	F			1240 x 600 x 5
24/4073-10	D6399	G		842 x 176 x 5		

**A** = Pare-brise / Windscreen  
**B** = Avant bas / lower front  
**C** = Haut porte / Top door  
**D** = Bas porte / Lower door  
**E** = Latérale / Side  
**F** = Arrière haut / Upper rear  
**G** = Arrière bas / Lower rear  
**6H** = 6 Trous / 6 Holes  
**L** = Gauche / Left  
**R** = Droite / Right  
**CL** = Claire / Clear

(1) 4110 & 4610 Seulement / Only  
 (2) 4110 & 4610 Avec chauffage / With heater fitted  
 (3) 2610, 3610, 234 & 334 Seulement / Only  
 (4) 2610, 3610, 234 & 334 Avec chauffage / With heater fitted

## SIEGE SEAT

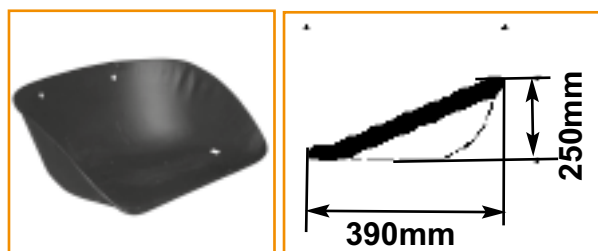

Tractors Tractores	Ref. Ref.	OEM	Description Description
20, 25, 35, 35X, 65, 100, 135, 165, 168, 175, 178, 185, 188, 230, 235, 240, 245, 265, 275, 290, 765, 825, 835, 865, 1000, TE20, TEA20, TED20, TEF20, TO20	<b>61/830-611</b>	181313M91, 891869M91	Acier / Steel

## HOUSSES SEAT COVER S

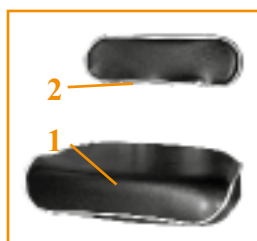

Tractors Tractores	Fig. Fig.	Ref. Ref.	OEM	Description Description
25, 35, 65, 122, 130, 133, 135, 140, 165, 168, 175, 178, 185, 230, 235, 240, 245, 265, 275, 290, 765, 825, 835, 865	1	<b>61/831-1</b>	965447M91, 1884576M91	Assise / Seat
	2	<b>61/832-1</b>	1883238M91, 1638480M91	Dossier / Back rest

## JANTES AVANT 2 RM FRONT WHEELS 2 RM

Tractors Tractores	ROUE AVANT FRONT WHEEL		
Dimension de la jante / Wheel size	4.50 x 16"	5.50 x 16"	5.50 x 16"
Dimension du pneu / Tyre size	6.00 x 16" 6.50 x 16"	6.50 x 16" 7.50 x 16"	7.50 x 16"
TEA20, TED20, TE F20, TEH20, 35, 122, 130, 835	<b>30/449-2</b> (885741T2)	<b>30/449-3</b> (1691618M92)	
65, 765, 865			
133, 135, 140, 145, 148, 152			
155, 158, 165, 168			
175, 178, 185, 188	<b>30/449-2</b> (885741T2)	<b>30/449-3</b> (1691618M92)	
230, 243, 253, 260, 263			
235, 240, 245, 250, 255			
265			
275, 275E, 285, 290, 290E		<b>30/449-4</b> (3827583M91)	
298			



### Jantes arrières 2RM Rear wheels 2WD

**30/449-18** Roue complète / Complete wheel  
**30/449-19** Jante seul / Rim only



## CALANDRES FRONT GRILL

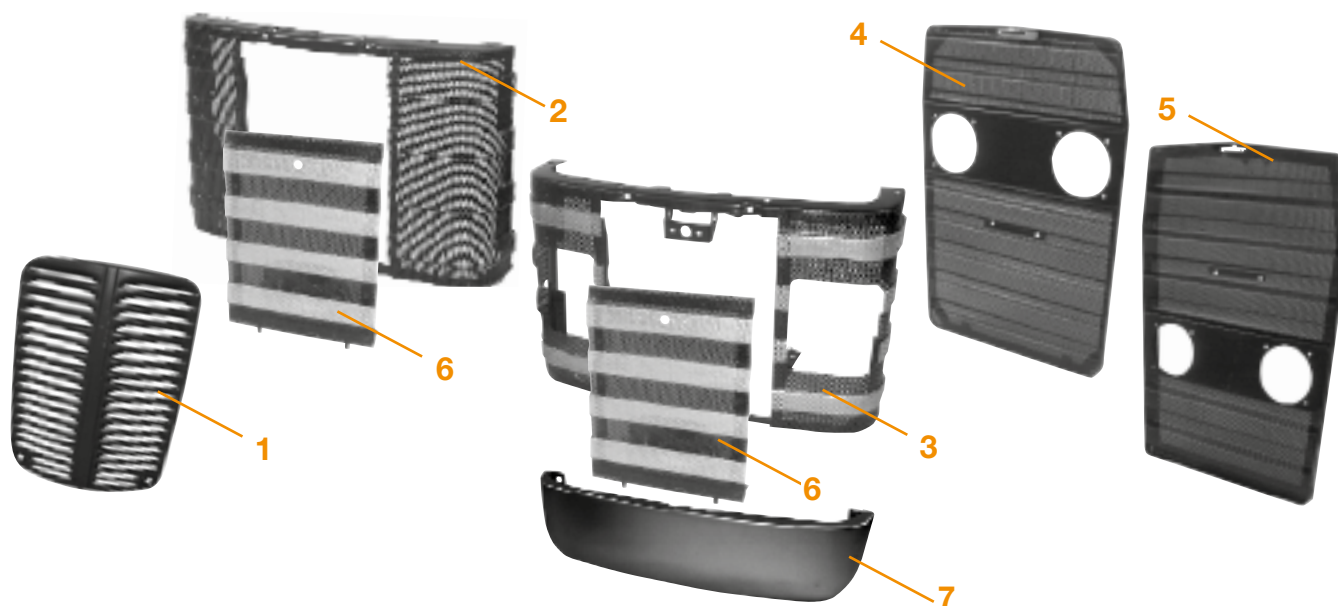

Tractors <i>Tractores</i>	Calandre sans phares <i>Front grille less light</i>	Calandre avec phares <i>Front grille with light</i>	Porte de calandre <i>Front grille door</i>	Bas de calandre <i>Lower panel</i>	
35, FE35, 835	<b>30/840-4</b> (826812M91)	1			
135 (⇒ 400000)	<b>30/840-1</b> (1882982M92)	2	<b>30/841-1</b> (1886314M91)	<b>30/843-5</b> (1882985M1)	
135 (400001 ⇒) 148	<b>30/840-2</b> (1861365M91)		<b>30/841-2</b> (1861364M91)		<b>30/842-2</b> (1861374M91)
165, 168, 175, 178, 185, 188	<b>30/840-3</b> (1886315M91, 897949M92)		<b>30/841-3</b> (1860167M91, 898542M92)		<b>30/842-3</b> (897960M92, 847848M91)
230, 240, 253, 263, 250, 254, 260, 264, 274. 284, 294			<b>30/841-4</b> (1688814M92, 3701928M91, 1687819M91, 1682953M91)		
265, 275, 290, 298, 675, 690, 698, 699, 1004			<b>30/841-5</b> (1687817M91)		

**GARDE-BOUES**  
**FENDERS**



Tractors Tractores	Fig. Fig.	Ref. Ref.	OEM	Description Description
TE20, 35, 35X	1	30/844-10	1883356M92	Gauche ou droit avec armature LH or RH with bracket
		30/844-11		Gauche ou droit sans armature LH or RH less bracket
TE20, 35		30/844-11SO		Revêtement seul, protection type court Skin only shell type short
35, 35X, 135	2	30/844-12	897751M91 1884286M97	Droit / RH
		30/844-13	897752M91 1884287M97	Gauche / LH
135	3	30/844-14	1885023M95	Droit avec coffre à outils RH with tool box
		30/844-15	1885024M95	Gauche avec coffre à outils LH with tool box
135, 230, 240	4	30/844-17	1679373M94	Droit sans coffre à outils, avec feu avant RH less tool box and with front side light
		30/844-16	1679374M94	Gauche sans coffre à outils, avec feu avant LH less tool box and with front side light
165	3	30/844-64	1884878M91	Avec boîte à outil (Droit) With tool box RH
		30/844-65	1884879M91	Avec boîte à outil (Gauche) With tool box LH
230, 240, 250, 298	6	30/844-30	1679373M94	Avec pièces complémentaire (Droit) With extension RH
		30/844-31	1679374M94	Avec pièces complémentaire (Gauche) With extension LH

**PANNEAUX**  
**PANNELS**

30/844-22K



30/844-23K



30/844-80K

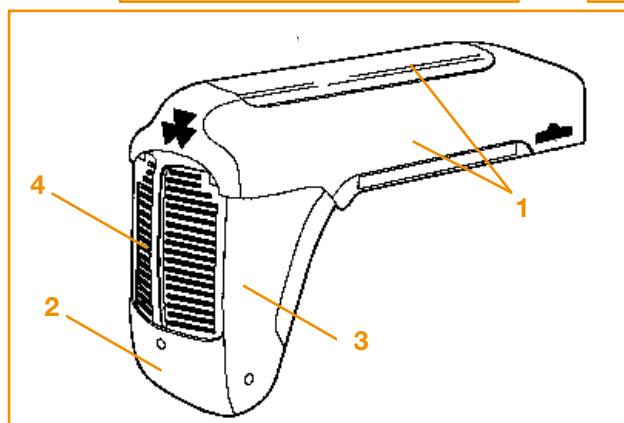
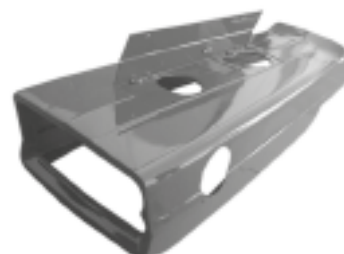

Tractors Tractores	Jeu capot Bonnet kit	Panneau capot Hood side panel	Panneau inférieur Lower screen	Panneau latéral Side panel	Calandre Grill
35, 35X, 835 35FE*	<b>30/844-22K</b> (828222M91 + 826817M92 + 1884060M91 + 826815M91 + 826816M91 + 826812M91)		<b>30/843-1</b> (826817M92)  <b>30/843-1H</b> Avec trou pour manivelle With handle hole	Gauche / LH <b>30/844-1</b> (3cyl.) (826816M91) <b>30/844-70*</b> (4cyl.)  Droit / RH <b>30/844-2</b> (3cyl.) (826815M91) <b>30/844-71*</b> (4cyl.)	<b>30/840-4</b> (826812M91)
133, 135, 140	<b>30/844-23K</b> (1884310M92 + 1882984M92 + 1886314M91 + 1882985M1 + 897822M1 + 897823M1)	1 + 2 + 3 + 4	1  <b>30/843-5</b> (1882985M1)	2  <b>30/844-26</b> (897822M1)  Droit / RH <b>30/844-27</b> (897823M1)	3  <b>30/841-1</b> (1886314M91) + <b>30/842-1</b> (1882984M92)
165, 165MKIII, 168, 175S, 178, 185, 188	<b>30/844-80K</b> (1884296M93)	Gauche / LH <b>30/839-5</b> (1883374M1)  Droit / RH <b>30/839-6</b> (1883373M1)	<b>30/838-4</b> (1886316M1)	Gauche / LH <b>30/844-28</b> (847844M91)  Droit / RH <b>30/844-29</b> (847845M91)	<b>30/841-3</b> (1860167M91, 898542M92) + <b>30/842-3</b> (897960M92, 847848M91)

**DELCACOMANIES**  
**DECAL SETS**

Tractors Tractores	Jeu Set	Emblème Emblem
230	<b>30/860-6</b> (3900614M91)	<b>30/863-13</b> (1682944M91)
240	<b>30/860-7</b> (3406978M92)	
250	<b>30/860-8</b> (3406979M91)	
265	<b>30/860-9</b> (3406981M91)	
275	<b>30/860-10</b> (3406983M92)	
290	<b>30/860-12</b> (3406895M92)	
340	<b>30/860-106</b> (3900562M91)	
350	<b>30/860-108</b> (3900316M91)	
355	<b>30/860-109</b> (3900317M91)	
360	<b>30/860-107</b> (3900318M91)	
365	<b>30/860-125</b> (3900320M92)	
375	<b>30/860-111</b> (3900321M92)	
390, 390T (⇒ B18008)	<b>30/860-112</b> (3900322M92)	
390 (B18009 ⇒)	<b>30/860-113</b> (3901083M91)	
390T (B18009 ⇒)	<b>30/860-126</b> (3901084M91)	
398	<b>30/860-127</b> (3900323M92)	
399	<b>30/860-114</b> (3900324M92)	
590	<b>30/860-17</b> (3900328M91)	
595	<b>30/860-18</b> (3900329M91)	
675	<b>30/860-19</b> (3900330M91)	
690	<b>30/860-20</b> (3900331M91)	
698 (2WD)	<b>30/860-21</b>	<b>30/863-13</b> (1682944M91)
698 (4WD)	<b>30/860-22</b>	
699	<b>30/860-24</b> (3900332M1)	

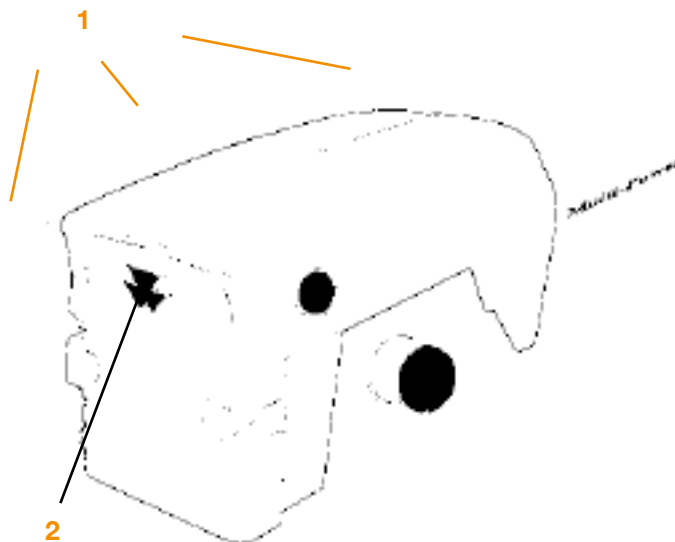

Tractors Tractores	Jeu Set	Emblème Emblem
3060	<b>30/860-115</b> (3902040M91)	<b>30/863-13</b> (1682944M91)
3065	<b>30/860-116</b> (3902048M91)	
3070	<b>30/860-117</b> (3900345M92)	
3075	<b>30/860-118</b> (3902049M91)	
3080	<b>30/860-119</b> (3900346M91)	
3085	<b>30/860-120</b> (3902043M91)	
3090	<b>30/860-121</b> (3900347M91)	
3095	<b>30/860-122</b> (3902042M91)	
3120	<b>30/860-123</b> (3902044M91)	
3125	<b>30/860-124</b> (3902038M91)	

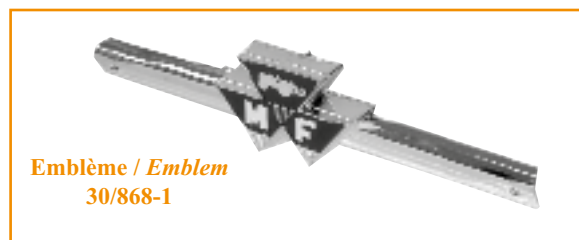



## MARCHE-PIEDS FOOTSTEPS



Tractors Tractores	Fig. Fig.	Ref. Ref.	OEM	Description Description
35, 35X, FE35	1	30/848-1	892776M91	Marche-pieds gauche avec anti-dérapant <i>Foot plate LH swept back axle c/w s f</i>
		30/849-1	892775M91	Marche-pieds droit avec anti-dérapant <i>Foot plate RH swept back axle c/w s f</i>
135, 135 Petrol, 35, 35X, FE35, TE20, TEA20, TED20, TEF20, TO20, TO30, TO35	2	30/848-2	890353M91	Marche-pied gauche sans sécurité <i>Foot plate LH without safety</i>
		30/849-2	890352M91	Marche-pied droit sans sécurité <i>Foot plate RH without safety</i>
135, 135 Petrol	3	30/848-3	847877M91	Marche-pieds gauche avec anti-dérapant <i>Foot plate LH swept back axle c/w s f</i>
		30/849-3	847878M91, 880336M92, 880096M93	Marche-pieds droit avec anti-dérapant <i>Foot plate RH swept back axle c/w s f</i>

## BOITES A OUTILS TOOL BOXES

**70/1563-15**  
(825633M91)  
Large

TE20, 25, 35, 35X, 135



**70/1563-16**  
(909616M95)  
Petit / Small

Pour toutes séries et  
sur demande  
*Tool box for series and  
has demand*



**70/1563-14**  
TE20, 35, 35X, 135

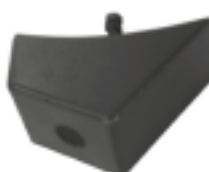

## CONTACTEURS SWITCHES



Tractors Tractores	Fig. Fig.	Ref. Ref.	OEM	Description Description
<b>Contacteurs de démarrage / Starting switches</b>				
35, 65, 135, 148, 165, 168, 175, 175S, 178, 185, 188, 765	1	<b>30/950-1</b>	883928M91	0 - Préchauffage - Démarrage (3 bornes) 0 - Heating - Start (3 terminals)
Séries 100, 200, 300, 500 Series 1007	2	<b>30/950-2</b>	1874535M3	0-Contact-Préchauffage-Démarrage(4 bornes) 0-Ignition-Heating-Start(4 terminals)
Remplace clef de 30/950-1 & 30/950-2 Replacement keys for 30/950-1 & 30/950-2	3	<b>30/951-2</b>	3813361M1	Clef Key
Séries 100, 200 series (Italie / Italy) 1004, 1014, 1024, 1114, 1135	4	<b>30/950-36</b>	3302034M91	Préchauffage - 0 - Contact - Démarrage Heating - 0 - Ignition - Start
<b>Contacteurs d'éclairage / Light switches</b>				
Séries 200, 500 series 133, 135, 140, 148, 152, 155, 158, 165, 168, 178, 185, 188, 2620, 2640, 2680	5	<b>30/953-1</b>	1668816M2	0 - Position - Croisement - Route + Claxon 0 - Parking - Traffic - Driving beams + Horn
		<b>30/954-1</b>	1668830M91	Bouton / Knob
Séries 100, 200 series	6	<b>30/953-11</b>	1825360M91	0 - Position - Croisement - Route + Claxon 0 - Parking - Traffic - Driving beams + Horn
1114, 1134	7	<b>30/953-1</b>	1425878M91	4 positions 4 positions
Séries 100, 200, 600 series (Italie / Italy) 675, 690, 698, 699, 1004, 1014, 1024, 1114, 1134	8	<b>30/953-14</b>	3300530M91	5 positions 5 positions
FE35, 35, 35X, 133, 135, 148-155, 158, 165, 168, 175, 178, 185, 188, 560, 575	13	<b>30/953-25</b>	882283M1	
<b>Contacteurs de clignotant / Blinking light switches</b>				
Séries 100, 200, 500, 4200, 4300 series 2620, 2640, 2680	9	<b>30/956-1</b>	881670M1	
Série 200 series 364, 394, 690, 698, 699, 1004, 1014, 1024, 1114, 1134	10	<b>30/956-10</b>	1424108M92	
Séries 100, 200, 500 series 2620, 2640, 2680	11	<b>30/957-1</b>	1671544M1	Commande feux de détresse Warning light control
230, 240, 250, 253, 263, 265, 275, 290, 298, 375, 390	12	<b>30/956-11</b>	1682977M1	Clignotants + feux de détresse + centrale clignotante Indicator + Warning light + blinking unit

## TABLEAU DE BORD ET AUTRE DASH PANEL AND OTHER



Tractors Tractores	Fig. Fig.	Ref. Ref.	OEM	Description Description
35, 35X	1	30/843-13		Tableau de bord (haut) Dash instrument panel (Top)
35, 35X, 122, 130, 133, 135, 140 133, 135, 135V, 148, 145V, 145S, 152, 152F, 152V, 152S (⇒11-1981-1)	2	30/843-15	892639M92	Protection de l'alternateur Dynamoguard
35, 35X	3	30/843-11	890490M91	Protection pour l'attelage PTO guard linkage
65	4	30/843-12		Protection PTO guard
135	5	30/843-9		Tableau de bord (haut) Instrument panel for both (top)
	6	30/843-10		Tableau de bord (bas) Under dash panel (under)
	3	30/843-11	890490M91	Protection pour l'attelage PTO guard linkage
165	7	30/843-14	1884364M93	Tableau de bord Instrument panel for both

**BEPCO PARTS SA****HERMALLE-SOUS-HUY**

Rue Chaumont, 4D • 4480 Hermalle-sous-Huy • Belgique  
T +32 85 24 54 00 • F +32 85 24 54 50  
info.be@bepcoparts.com • www.bepcoparts.com

**VILLERS-LE-BOUILLET**

Rue de Waremme, 114 • 4530 Villers-le-Bouillet • Belgique  
T +32 85 24 54 00 • F +32 85 24 54 50  
info.be@bepcoparts.com • www.bepcoparts.com

**BEPCO UK LTD**

Bepco House • Unit 316 • Hartlebury Trading Estate  
Hartlebury - Worcestershire, DY10 4JB (UK)  
P +44 (0)1299 252270 • F 0800 216553  
info@bepcoparts.com • www.bepcoparts.com

**BEPCO FRANCE SAS**

Z.I. La Plaine, Allée de Bigorre  
BP80041 Le Passage • 47901 Agen Cedex 9 • France  
T +33 (0)553 96 31 25 • F +33 (0)553 68 03 72  
info.fr@bepcoparts.com • www.bepcoparts.com

**VILLENEUVE-SUR-LOT**

294 Av. de Bordeaux • CS 30059 Bias  
FR-47302 Villeneuve sur lot • France  
T +33 (0)5 53 40 37 50 • F +33 (0)5 53 70 61 93

**JANZÉ**

P.A. de la Chauvelière • Rue Charles Lindbergh  
35150 JANZE • France  
T + 33 (0)2 99 44 16 18 • F +33 (0)2 99 44 17 29

**TVH AUSTRALASIA PTY LTD**

HEAD OFFICE BRISBANE • www.bepcoparts.com

**ADELAIDE**

96 South Terrace • Wingfield SA 5013  
Free 1800 182 344 • T +61 8 8359 8933 • F +61 8 8234 2212  
BepcoSAsales@tvh.com.au

**BRISBANE**

735 Boundary Road • Richlands QLD 4077  
Free 1800 020 082 • T +61 7 3344 1113 • F +61 7 3344 1332  
BepcoQLDsales@tvh.com.au

**MELBOURNE**

7/66-74 Micro Circuit • Dandenong South VIC 3175  
Free 1800 802 367 • T +61 3 9796 5422 • F +61 3 9796 5251  
BepcoVICsales@tvh.com.au

**PERTH**

2/15 Colin Jamieson Drive • Welshpool WA 6106  
Free 1800 182 344 • T +61 8 8352 8984 • F +61 8 8234 2212  
BepcoWAsales@tvh.com.au

**SYDNEY**

1/1002-1010 Canley Vale Rd • Wetherill Park NSW 2164  
Free 1800 808 827 • T +61 2 6885 5288 • F +61 3 9796 5251  
BepcoNSWsales@tvh.com.au

**TVH NEW ZEALAND LTD****AUCKLAND**

PO Box 51490 • Pakuranga 2140 • 11K Echelon Place  
East Tamaki • Auckland  
Free 0800 459 662 • T +64 9 274 9695 • F +64 9 274 9698  
info@tvh.co.nz • www.tvh.com

**CHRISTCHURCH**

11C Parkhouse Road  
Wigram • Christchurch 8042  
Free 0508 8 722 867 • T +64 3 550 1298 • F +64 3 974 9993  
infochch@tvh.co.nz

**BEPCO DEUTSCHLAND GmbH**

Neuer Weg 5 • 59505 Bad Sassendorf • Germany  
T +49 (0)2927 919 59 0 • F +49 (0)2927 919 59 59  
info.de@bepcoparts.com • www.bepcoparts.com

**BEPCO NEDERLAND BV**

Den Dolvert 10 • 5473 GP, Heeswijk-Dinther • Nederland  
T +31 (0)413 29 39 75 • F +31 (0)413 29 40 87  
info.nl@bepcoparts.com • www.bepcoparts.com

**BEPCO IBÉRICA SA**

C/ Torrent de Vallmajor, 82  
08915 Badalona (Barcelona) • Spain  
T +34 (0)902 111 062 - 933 810 062 • F +34 (0)933 813 345  
info.es@bepcoparts.com • www.bepcoparts.com

**ALMENDRALEJO**

Ctra. Badajoz - Pol. «Rayvaz» Nave 21  
06200 Almendralejo (Badajoz)  
T +34 (0)902 111 062 - 924 664 890  
F +34 (0)924 664 576

**DOS HERMANAS**

Pol. Ind. La Isla, C/ Hornos, 11  
41703 Dos Hermanas (Sevilla)  
T +34 (0)902 111 062 - 954 931 546  
F +34 (0)954 930 130

**SANTIAGO DE COMPOSTELA**

Pol. El Tambre, Via Faraday, 36  
15890 Santiago de Compostela  
T +34 (0)902 111 062 - 981 560 012  
F +34 (0)981 557 753

**TVH PARTS SOUTH AFRICA (Pty) Ltd**

HEAD OFFICE JOHANNESBURG • www.tvh.com

**CAPE TOWN**

1 Karee Street • Kraaifontein Industries • Cape Town 7571  
T +27 21 988 2432 • F +27 21 988 9127  
capetownsales@tvh.com

**DURBAN**

2 Monaco Place • Westmead • Pinetown 3600  
T +27 31 100 0760 • F +27 31 700 6191  
durbansales@tvh.com

**JOHANNESBURG**

90 Electron Avenue • Isando • Kempton Park 1601  
T +27 11 281 27 00 • F +011 974 9845  
johannesburgsales@tvh.com

**LICHTENBURG**

Shop 1 • 109 Scholtz Street • Lichtenburg 2740  
T +27 18 632 6192/6092 • F +27 18 632 6108  
lichtenburgsales@tvh.com

**PORT ELIZABETH**

134 Kempston Road • Korsten • Port Elizabeth 6020  
T +27 41 453 1404/8 • F +27 41 453 1409  
portelizabethsales@tvh.com

## FOR ALL OUR LATEST CATALOGUE UPDATES AND COMPANY INFO: [WWW.BEPCOPARTS.COM](http://WWW.BEPCOPARTS.COM)



The spare parts mentioned in this list can normally be delivered from stock. In addition, we can supply parts, which are not mentioned in this catalogue, with the shortest possible delivery time. The O.E.M. references are only for indication purposes and do not imply that the spare parts are coming from the manufacturer. This spare parts list can be modified without prior notice. All photographs, drawings, illustrations, brand names, descriptions and numbers are included for identification purposes only.



De onderdelen vermeld in deze lijst, zijn normaal uit voorraad leverbaar, behoudens uitverkocht. Ook niet-vermelde onderdelen kunnen binnen de kortste tijd uitgeleverd worden. De O.E.M. referenties dienen enkel ter indicatie en impliceren niet dat deze van de vermelde constructeur afkomstig zijn. Deze onderdelenlijst kan zonder enige voorafgaande verwittiging aangepast worden. Alle gebruikte foto's, tekeningen, afbeeldingen, merknamen, omschrijvingen en nummers dienen alleen ter identificatie.



Les pièces de rechange, mentionnées dans cette liste, sont normalement livrables du stock. En plus, les articles non indiqués peuvent être fournis en peu de temps. Cette liste peut être modifiée sans avis préalable. Les références O.E.M. sont seulement indicatives et n'impliquent pas que les pièces de rechange viennent du constructeur. Toutes les photographies, illustrations, marques, descriptions, tous les plans et numéros servent exclusivement à une identification.



Die in dieser Liste aufgeführten Teile sind normalerweise aus dem Lager lieferbar. Wir sind zudem in der Lage nicht aufgeführte Teile innerhalb kürzester Zeit zu liefern. Die O.E.M. Referenznummern dienen zur Information und beinhalten nicht, dass diese vom genannten Hersteller kommen. Diese Bestandsliste kann ohne vorhergehende Ankündigung geändert werden. Alle verwendeten Foto's, Zeichnungen, Abbildungen, Markennamen, Beschreibungen und Nummern dienen nur zu Identifikationszwecken.



Los artículos mencionados en este catálogo se encuentran habitualmente en stock. Además, podemos suministrar en un plazo corto de tiempo otros artículos relacionados que no se encuentren expresamente mencionados en este catálogo. Las referencias O.E.M. sirven sólo como indicación y no implican que procedan del constructor. Este listado de productos puede estar sujeto a modificaciones sin aviso previo. Todas las fotos, dibujos, ilustraciones, nombres de marca, descripciones y números se han incluido simplemente con el propósito de su identificación.



I pezzi di ricambio, menzionati in questo listino, possono essere forniti con una consegna immediata a condizione che non siano esauriti. I pezzi di ricambio non menzionati possono essere forniti in poco tempo. Le referenze O.E.M. sono solamente indicative e non implicano che i pezzi di ricambio vengano da questo costruttore. Questa lista ricambi può essere aggiustata senza avvisi anticipati. Tutti i numeri, codici, nomi, foto, spaccati e disegni sono solo a titolo informativo.



Części z tego katalogu są zazwyczaj na stanie magazynowym. Również części które nie są wyszczególnione w katalogu mogą być dostarczone na zamówienie w najkrótszym możliwym terminie. Opis części O.E.M. jest używany informacyjnie i nie wskazuje na to, że dany produkt jest wyprodukowany przez podanego producenta. Zawartość katalogu może ulec zmianie bez wcześniejszego informowania o tym. Wszystkie użyte zdjęcia, rysunki, nazwy marek, opis i numery służą tylko do identyfikacji.



Запчасти из настоящего списка, как правило, имеются в запасе, если только он не распродан. Прочие, не фигурирующие в списке артикулы, могут быть поставлены в самые кратчайшие сроки. Указание оригинальных номеров производителя не предполагает обязательного оригинального происхождения самих деталей. Данный список может изменяться без предварительного уведомления. Все использованные фото, рисунки, иллюстрации, названия брендов, наименования и номера служат исключительно для цели идентификации.

Visitez notre site :  
**[www.bepcoparts.com](http://www.bepcoparts.com)**

© **bepco 2016**

Tous droits réservés. Aucune partie de ce catalogue ne peut, ni intégralement, ni partiellement être reproduite ou communiquée (copiée, sauvegardée, utilisée dans un système de sauvegarde de données, etc) sous n'importe quelle forme, soit numérique ou mécanique, sans accord préalable et explicite de la société BEPCO PARTS.

- BEPCO est un fournisseur de pièces de rechange et accessoires d'après-vente qui sont appropriés pour l'entretien et la réparation des équipements OEM. Les Références OEM et marques sont à titre purement indicatif et ne signifient pas que les accessoires et/ou pièces de rechange viennent du fabricant de l'équipement ou des pièces d'origine.
- Les produits qui ne sont pas conformes aux exigences réglementaires concernant la conformité de la CE ne sont pas mis sur le marché dans l'Espace économique européen.
- BEPCO® est une marque déposée.
- Toutes les ventes sont soumises aux termes et conditions générales de vente sur [www.bepcoparts.com](http://www.bepcoparts.com)
- Les photographies et les illustrations sont inclus à titre de référence seulement. Sous réserve d'erreurs d'impression.



Visit us on the Internet:  
**[www.bepcoparts.com](http://www.bepcoparts.com)**

© **bepco** 2016

All rights reserved. No part of this catalogue may be reproduced or communicated in any form or by any means, electronic or mechanical, including copying, recording or use in an information storage or retrieval system, without prior and explicit permission of BEPCO PARTS.

- BEPCO is a supplier of after-market spare parts and accessories that are suitable for the maintenance and repair of OEM-equipment. OEM references and brands are purely indicative and do not imply that the accessories and/or spare parts are coming from the original equipment or parts manufacturer.
- Products that do not comply with regulatory requirements concerning CE conformity are not placed on the market in the European Economic Area.
- BEPCO® are registered trademarks.
- All sales are subject to the general terms & conditions of sale on [www.bepcoparts.com](http://www.bepcoparts.com)
- Photographs and illustrations are included for reference purposes only. Printing errors reserved.

**Pièces détachées**  
*de A à Z*  
**toutes marques**

**Spare parts**  
*from A-Z for*  
**all brands**

Case IH  
David Brown  
Fendt  
Ford  
Fiat  
Hürlimann  
JCB  
John Deere  
K.H.D. (Deutz)  
Kubota  
Landini  
Lamborghini  
Manitou  
Massey Ferguson  
Mc Cormick  
Merlo  
New Holland  
Renault  
Same  
Steyr  
Valmet  
Zetor

**moving forward in every field**

REF. B71122



**HEAD OFFICE**

Rue Chaumont 4D • 4480 Hermalle-sous-Huy • Belgium  
T +32 (0)85 24 54 00 • F +32 (0)800 23 132 • info.be@bepcoparts.com • www.bepcoparts.com

Member of **TVH** 