



moving forward in every field

LANGUE/LANGUAGE • FR/EN

MASSEY FERGUSON

▶▶ PIÈCES DE TRACTEURS/TRACTOR PARTS

Catalogue - Première publication 2004

Catalogue - First published 2004

www.bepcoparts.com

Member of **TVH** 

■ À PROPOS DE BEPCO

Le groupe Bepco est un leader mondial dans la fourniture de pièces de rechange, accessoires pour tracteurs et pièces détachées pour machines agricoles.

Avec plus de 360 employés, le groupe Bepco a des filiales en Belgique, France, Pays-Bas, Allemagne, Espagne et Angleterre. Nous sommes aussi présents en Australie, Nouvelle Zélande, Afrique du sud et au Brésil.

Le groupe Bepco est une société mondiale avec des clients dans plus de 100 pays à travers le monde, les ventes hors Europe contribuent à plus d'un tiers du chiffre d'affaires.

Nous proposons à notre réseau de distributeurs et revendeurs :

- ▶ Des fournisseurs d'équipements d'origine et d'autres marques reconnues
- ▶ Plus de 20 000 m² de surface de stockage
- ▶ Plus de 80 000 références en stock
- ▶ Des connaissances techniques d'experts de l'industrie
- ▶ Une expédition le jour même pour une livraison le jour suivant

Le groupe Bepco fait partie du groupe TVH, fournisseur de pièces et accessoires de qualité pour le matériel de manutention, les véhicules industriels et l'équipement agricole.

ABOUT BEPCO

Bepco Group is a worldwide leading supplier of parts and accessories for agricultural tractors and machinery.

With over 360 employees Bepco Group has subsidiaries in Belgium, Netherlands, France, Germany, Spain and UK and is also present in Australia, New Zealand, South Africa and Brazil.

Bepco Group is a truly global company with customers in over 100 countries worldwide and sales outside Europe contributing to over a third of revenues.

We offer our network of distributors and dealers :

- ▶▶ Original Equipment Supplier and other industry leading brands
- ▶▶ More than 20,000 m² of warehousing
- ▶▶ More than 80,000 stock items
- ▶▶ Technological knowledge from industry experts
- ▶▶ Same day shipment, next day delivery in many markets

Bepco Group is also a member of TVH, the all-round supplier of quality parts and accessories for material handling, industrial vehicles and agricultural equipment.

MASSEY-FERGUSON

Pompe hydraulique - Hydraulic pump - Hydraulikpumpe
Hydrauliekpomp - Bomba hidráulica



	Part N°	OEM	Débit Flow Druck Debiet Flujo	Description Beschreibung Omschrijving Descripción
2225, 2230, 2235	69/565-244	3652099M91 3652099M92	14cc+8cc	Rotation gauche Left rotation Drehrichtung links Draairichting links Rotación izqu.

Massey-Ferguson PARTS

**Pompe hydraulique - Hydraulic pump - Hydraulikpumpe -
Hydrauliekpomp - Bomba hidráulica**

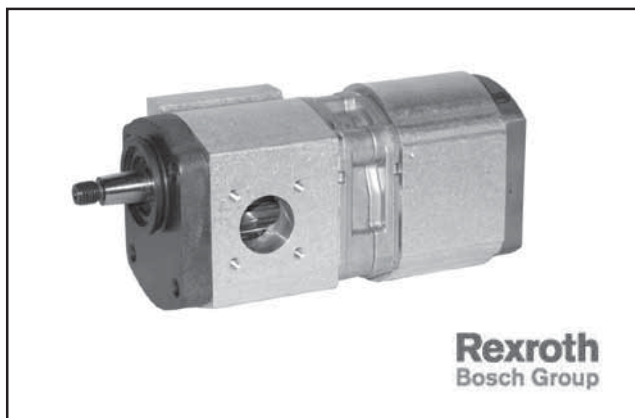

	Part N°	OEM	Débit Flow Druck Debiet Flujo	Description Beschreibung Omschrijving Descripción
5445, 5455, 5460, 5460SA, 5465, 5465 (Tier 3), 5470, 5475, 5475 (Tier 3), 5480 6235, 6245, 6255, 6260, 6265, 6270, 6280, 6290, 6445, 6455, 6460, 6470, 6475, 6480, 6485, 6490, 6495	69/565-240	3797116M1	19cc+14cc	Relevage - rotation gauche Lift - left rotation Kraftheber - drehrichtung links Hefinrichting - draairichting links Alzamiento - Rotación izqu.

Les références des pièces sont indicatives.
Nos pièces ne sont pas d'origine.

Part numbers are quoted for reference purposes only.
Our parts and accessories are not original.



PERKINS PARTS

Nouvelle disponibilité en short bloc (complet)
News availabilities of short bloc (complete)
Neue verfügbare Motorblock (Komplett)
Nieuwe beschikbare motorblok (kompleet)
Nuevas disponibilidades en motor bloqueo (completo)

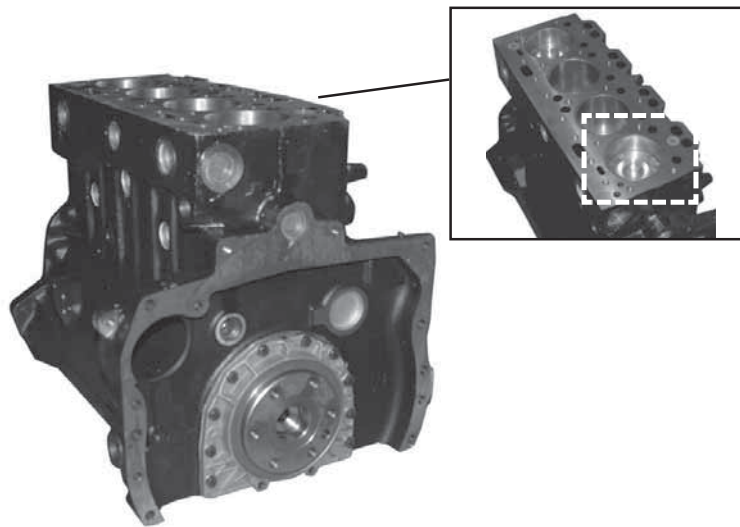

Short block Motorblock Motorblok Motor bloqueo	Piston Kolben Zuiger Pistón	Model	Cylinders	Nominal HP
30/6001-5	-	A4.248	4	80
30/6001-6	-	A4.236		70
30/6001-7	30/33-7 68332 5 segments - 5 Rings 5 Ringen - 5 Rings 5 Segmentos	AD3.152	3	57
NEW 30/6001-8	30/33-8 89214 4 segments - 4 Rings 4 Ringen - 4 Rings 4 Segmentos			

Consultez nous pour tous renseignements complémentaires sur cette nouvelle gamme
Consult us for further information about this new range
Fragen Sie uns für nähere Angaben zu diesem Programm
Raadpleeg ons voor nadere inlichtingen omtrent dit gamma
Consultar nosotros para todas información complementarias con esta nueva gama

Les références des pièces sont indicatives.
Nos pièces ne sont pas d'origine.

*Part numbers are quoted for reference purposes only.
Our parts and accessories are not original.*



MASSEY-FERGUSON PARTS

Embrayages - Clutches - Kupplungen - Koppelingen - Embragues

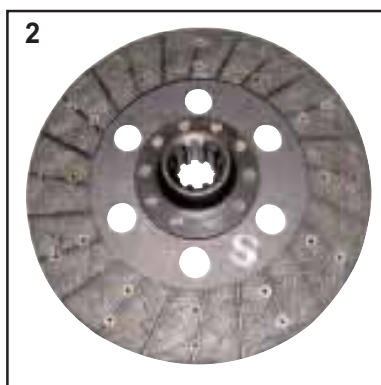
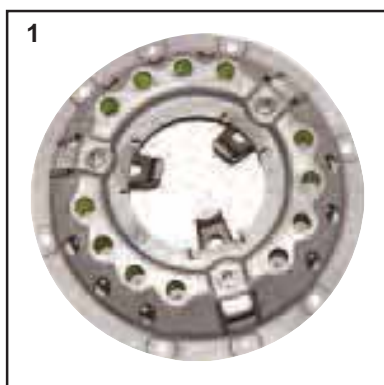

	1		2		3	
	Embrayage Clutch Kupplung Koppeling Embrague		Disque Plate Scheibe Rijplaat Disco		Butée de débrayage Release bearing Drucklager Drukklager Rodamiento	
TEF20 (Diesel)	10" 250 GA3	30/200-316 NEW	10"	30/221-227 UF 10Z 29x35 (8778)	30/231-23 52x84x20 (4069) 3-1 30/230-1 AU (828123M2) 3-2	

AU = Roulement pilote / Spigot bearing / Pilotlager / Toplager / Rodamiento piloto

UF = Organique fixe / Fixed organique / Cerasinter-Belag, ungefedert / Sintermetaal, vast, niet geveerd / Cerametalico sin muelles



Les références des pièces sont indicatives.
Nos pièces ne sont pas d'origine.

Part numbers are quoted for reference purposes only.
Our parts and accessories are not original.



MASSEY-FERGUSON PARTS

Filtre à gasoil - Fuel filter - Kraftstoff-filter -
Brandstofffilter - Filtro de combustible

	Part N°	Dimensions - Size - Abmessungen - Afmetingen - Dimensiones	Fig. / Abb. / Afb.
5245, 5435, 5445, 5455 6445, 6455, 6460, 6470	60/111-176 (4224811M1)	75mm x 160mm	

Les références des pièces sont indicatives.
Nos pièces ne sont pas d'origine.

*Part numbers are quoted for reference purposes only.
Our parts and accessories are not original.*



"THE RELIABLE SERVICE"



MASSEY-FERGUSON PARTS

DIFFERENTIEL - COUPLE CONIQUE / DIFFERENTIAL - CROWN WHEEL & PINION /
DIFFERENTIAL - TELLER- UND KEGELRAD / DIFFERENTIEEL - KROONWIELSET / DIFERENCIAL - GRUPO CÓNICO

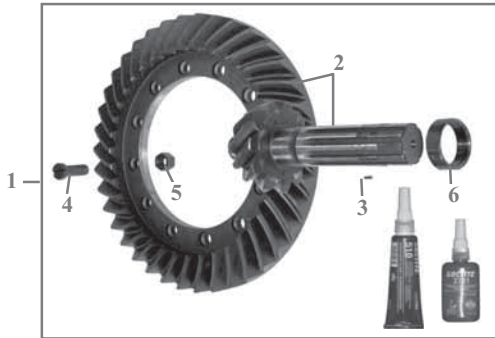

Voir page / Seite / pagina / paginà 283

- (A) Pignon / Pinion / Zahnrad / Tandwiel / Piñón 236.5 mm
 (B) Pignon / Pinion / Zahnrad / Tandwiel / Piñón 250.9 mm
 (C) Sans compteur de vitesse / Without Speedo /
 Ohne Geschwindigkeitsmesser / Zonder snelheidsmeter /
 Sin reloj de velocidad

Fig.	1	2	3	4	5	6
Tracteurs Tractors Schleppertyp Trekker-type Tractores	Kit couple con. Crown wh. kit Teller- und Kegelrad satz Kroonwielset j. grupo cónico	Couple con. Wheel & pinion Teller- und Kegelrad Kroon-pignonwiel Grupo cónico	Galet Needle roller Nadellager Naaldlager Rod. agujas	Vis Bolt Schraube Bout Tornillo	Ecrou Nut Mutter Moer Tuerca	Ecrou pignon Pinion nut Zahnradmutter Moer Tuerca
Tracteurs français, anglais, américains / French, UK, USA tractors / Französische, englische & amerikanische Traktoren / Frans, Engels, Amerikaanse traktoren / Tractores franceses, ingleses y americanos						
TEA20, TED20, TEF20, TEH20						
35 133, 135, 140 (Prem./ Early / Erste / Oudere Prim. 6 x 37)	30/340-1 (A) (1885317M92)	30/341-1 (A) (182115M91)				
133, 135, 140 (Dem. / Late / Letzte / Latere / Últim. 6 x 37) 135V, 145V	30/340-3 (B) (1683757M91)	30/341-3 (B) (B3413)				
65, 765, 865 135, 145, 148 (MKIII France - 11 x 38) 152, 155, 158, 165, 168, 175, 178, 185, 188 148 (UK)	30/340-4 (1664255M92)	30/341-4 (184382M92)				30/346-1 (532956M1)
230, 240 (6 x 37 - ⇒ B32999) 235, 245, 250 (6 x 37)	30/340-3 (1683757M91)	30/341-3 (B3413)				
230, 240 (6 x 37 - B33001 ⇒)						
240, 250, 255, 260, 265, 275, 285, 290 (11 x 38) 253, 275E, 290E (11 x 38 - ⇒ B32999)	30/340-4 (1664255M92)	30/341-4 (184382M92)				30/346-1 (C) (532956M1)
243, 263 253, 275E, 290E (11 x 38 - B33001 ⇒)						
275, 285, 290, 290E, 298 (9 x 35 & 10 x 39)						
340 (6 x 37)	30/340-3 (1683757M91)	30/341-3 (B3413)	30/339-1 (831485M1)	30/342-1 (825776M1)	30/343-1 (891947M1)	30/346-1 (532956M1)
342 (6 x 37)						
350, 355, 360 (11 x 38) 362, 365, 375, 375E, 390, 390E, 399 (11 x 38 - ⇒ B32999)	30/340-4 (1664255M92)	30/341-4 (184382M92)				30/346-1 (C) (532956M1)
350, 352, 355, 360, 362, 365, 375, 390, 390T, 396 (8 x 35)						
352, 362N, 372N, 382N, 390T, 396, 398 (11 x 38) 362, 365, 375, 375E, 390, 390E, 399 (11 x 38 - B33001 ⇒)						Ep. Th. T. Dik. Gr. 17mm 30/346-1 (532956M1)
375, 390, 390E, 398, 399 (9 x 35)	NEW 30/340-6 (3427116M91)					
550						
560, 565, 575, 590, 675, 690 (11 x 38)	30/340-4 (1664255M92)	30/341-4 (184382M92)				30/346-1 (532956M1)
575, 590, 675, 690, 698, 698T, 699, 1004, 1004T (9 x 35 & 10 x 39)						

Les références des pièces sont indicatives.
Nos pièces ne sont pas d'origine.



Part numbers are quoted for reference purposes only.
Our parts and accessories are not original.

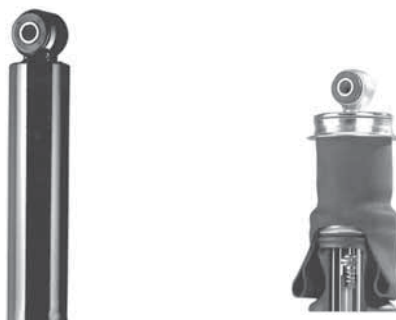

MASSEY-FERGUSON PARTS

AMORTISSEURS CABINE - CAB SHOCK ABSORBERS - FAHRERHAUSDÄMPFER -
CABINE DEMPERS - AMORTIGUADORES DE LA CABINA DE CONDUCTOR



	Ref.	OEM	Type de fixation Fastening type Befestigungsarten Verbindingswijze Tipo de fijación	Description Beschreibung Omschrijving Descripción
6445, 6455, 6460, 6465, 6470, 6475, 6480, 6485, 6490, 6495, 6497, 6499, 8260	30/4116-7 	3786040M1 3786040M2	Bossage en haut / Bossage en bas Top eye / Bottom eye Oberes Auge / Untenes Auge Bovenste ring / Onderste ring Anillo superior / Anillo inferior	-
7465, 7475, 7480, 7485, 7490, 7495	30/4116-8	4279945M1		
8450, 8460, 8470, 8480				

 Cabine / Cab / Kabine / Cabine / Cabina

Les références des pièces sont indicatives.
Nos pièces ne sont pas d'origine.

Part numbers are quoted for reference purposes only.
Our parts and accessories are not original.



PERKINS PARTS

Nouvelle disponibilité en short bloc (complet)
News availabilities of short bloc (complete)
Neue verfügbare Motorblock (Komplett)
Nieuwe beschikbare motorblok (kompleet)
Nuevas disponibilidades en motor bloqueo (completo)

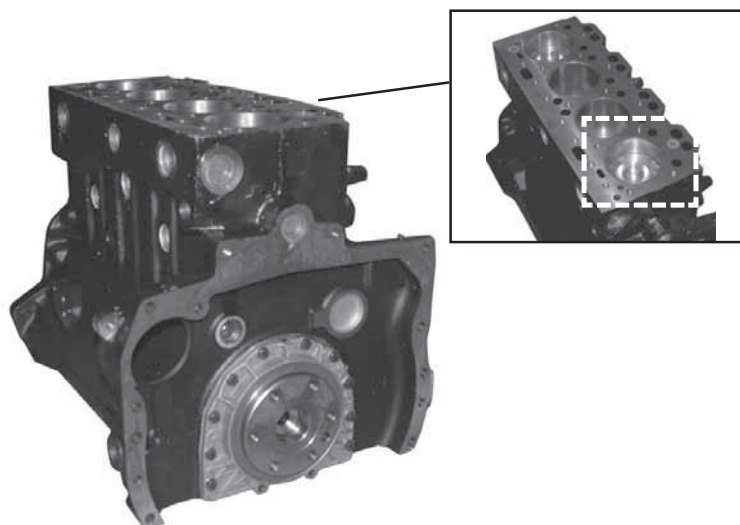

Short block Motorblock Motorblok Motor bloqueo	Piston Kolben Zuiger Pistón	Model	Cylinders	Nominal HP
30/6001-5	-	A4.248	4	80
30/6001-6	-	A4.236		70
30/6001-7	-	AD3.152	3	57

Consultez nous pour tous renseignements complémentaires sur cette nouvelle gamme
Consult us for further information about this new range
Fragen Sie uns für nähere Angaben zu diesem Programm
Raadpleeg ons voor nadere inlichtingen omtrent dit gamma
Consultar nosotros para todas información complementarias con esta nueva gama









Les références des pièces sont indicatives.
Nos pièces ne sont pas d'origine.

*Part numbers are quoted for reference purposes only.
Our parts and accessories are not original.*



MASSEY-FERGUSON PARTS

Bouchons divers - caps (miscellaneous) - Verschiedene deckel - verschillende doppen - Taponos (diversos)

	Parts N°	OEM	Description Beschreibung Omschrijving Descripción		
233, 253, 254, 254S, 263, 264, 273, 274, 274S, 283, 284, 293, 294, 1104, 1114, 1134	30/105-82	977093M91	Bouchon rempl. mazout Fuel tank cap Tankdeckel Brandstofftankdop Tapón depósito		
352, 362, 675, 690, 698, 699, 1004, 1004T 365, 375, 390, 390T, 398 (⇒B18009)	30/85-20	1682301M91	Bouchon d'huile boîte de vitesse Oil cap for gear box Oldeckel für Getriebe Olivedop voor versnellingsbak Tápon de aceite con caja de cambios		
399, 3085, 3095, 3115, 3120, 3125, 3635, 3645, 3655 4260, 4270 (⇒K37008)	30/85-21	748219M1			
230, 240, 240 (⇒A20287), 243, 240S, 265S, 275, 275 (⇒P12018), 285S, 290, 290(⇒P06156), 375E (⇒P12018), 390(⇒P06156), 390E (⇒P06156), 396, 399, 650, 660, 680, 3085, 3095, 3120, 3125 3315, 3325, 3330, 3340, 3350, 3355 V/S/F 3635, 3645, 3655 4215, 4220, 4225, 4235, 4240, 4245, 4255, 4260, 4265 (⇒K37008), 4270, 4315, 4320, 4325, 4335, 4345, 4355, 4360, 4365, 4370 5425, 5435, 5445, 5455, 5465 6160, 6170, 6180, 6235, 6245, 6255, 6260, 6265, 6270, 6280, 6290, 6445, 6455, 6460, 6465, 6470, 6475, 6480 7465, 7475, 7480 8110, 8120, 8130, 8210, 8220	30/85-22	3641889M1	Bouchon huile moteur Oil filler cap Öleinfülldeckel Olievuldop Tapón aceite		

Les références des pièces sont indicatives.
Nos pièces ne sont pas d'origine.

Part numbers are quoted for reference purposes only.
Our parts and accessories are not original.





"THE RELIABLE SERVICE"



MASSEY-FERGUSON PARTS

REFROIDISSEUR D'HUILE - OIL COOLER - ÖLKÜLHER - OLIE KOELER - REFRIGERADOR ACEITE

	N° de construction <i>Build number</i>	Ref.	
A4.236	LD, LJ, LH	30/6097-3 (P2486A219)	
1004.4	AA, AB, AE, AJ, AK, AQ, AR, AS		

Les références des pièces sont indicatives.
Nos pièces ne sont pas d'origine.



*Part numbers are quoted for reference purposes only.
Our parts and accessories are not original.*



"THE RELIABLE SERVICE"

MASSEY-FERGUSON PARTS

Radiateur - Radiator - Kühler - Radiator - Radiador

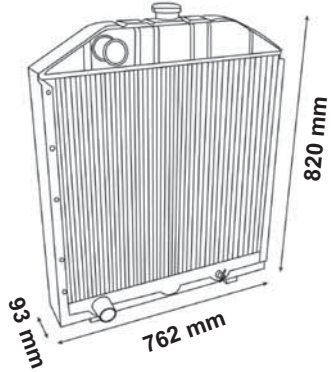
	Ref.	OEM		
8140, 8150, 8160	30/150-160	3713181M4 3713181M3	 	



Les références des pièces sont indicatives.
Nos pièces ne sont pas d'origine.

*Part numbers are quoted for reference purposes only.
Our parts and accessories are not original.*



MASSEY-FERGUSON PARTS

Démarrateurs - Starter motors - Anlasser - Startmotors - Motores de arranque

Applications <i>Applications</i>	Réf. <i>Ref.</i>	OEM	
Massey-Fergusson			
Moteurs / Engines / Motoren / Motores Perkins A3-152, AD3-152, A4-192, A4-203, AD4-203 65, 133, 134, 135, 140, 145, 148, 152, 154, 155, 158, 165/II, 230, 233, 234, 235, 240, 245, 250, 253, 254, 255, 260, 263, 264, 350, 353, 355, 360 363, 364, 550, 560	62/930-217 (Iskra) Avec réducteur <i>With reducer</i> 24V 4,0KW New	1680065M3 1868283M5 3597371M1 3597426M3 3763363M91	3x127 10Z  245
	62/930-218 (Magnetron) Avec réducteur <i>With reducer</i> 12V 3,0KW		3x146 10Z  205

Les références des pièces sont indicatives.
Nos pièces ne sont pas d'origine.

Part numbers are quoted for reference purposes only.
Our parts and accessories are not original.



MASSEY-FERGUSON PARTS

Siège (Pour tracteurs étroits) - Seat (Narrow tractors) - Sitze (Schmalspurschlepper) - Zitting (Smalspoor-tractoren) - Asiento (Tractores estrechos)

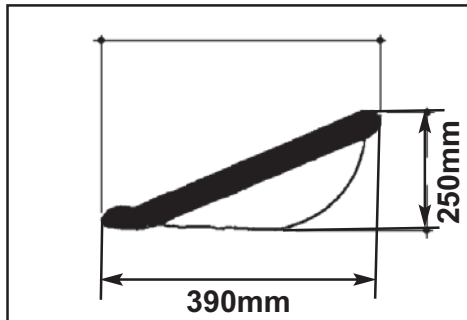

Caractéristiques techniques :

- Cuvette noir en acier
- Fixation centrale

Technical data :

- Black iron covering
- Central fitting

Technische Daten :

- Schwarzer Stahlblech
- Zentralbefestigung

Kenmerken :

- Zwart metaal
- Centrale bevestiging

Características técnicas :

- Acabado negro metálico
- Montaje central

61/830-611

(181313M91, 891869M91)

20, 25, 35, 35X, 65, 100, 135, 165, 168, 175, 178,
185, 188, 230, 235, 240, 245, 265, 275, 290, 765, 825,
835, 865, 1000, TE20, TEA20, TED20, TEF20, TO20

Les références des pièces sont indicatives.
Nos pièces ne sont pas d'origine.

Part numbers are quoted for reference purposes only.
Our parts and accessories are not original.





"THE RELIABLE SERVICE"



MASSEY-FERGUSON PARTS

Radiateur - Radiator - Kühler - Radiator - Radiador

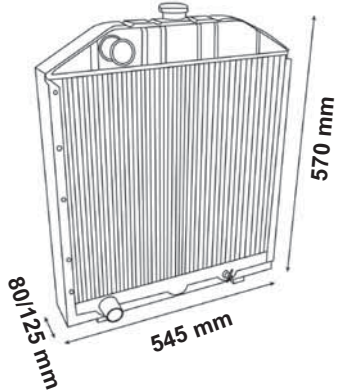
	Ref.	OEM		
<p>3050, 3060, 3065, 6120, 6130, 6140</p> <p>Avec capot plongeant With highvisibility bonnet Mit tiefer Motorhaube Met hellende motorkap Con capó desde arriba</p>	30/150-156	3618137M1	 <p>CE</p>	

Les références des pièces sont indicatives.
Nos pièces ne sont pas d'origine.

Part numbers are quoted for reference purposes only.
Our parts and accessories are not original.



"THE RELIABLE SERVICE"



MASSEY-FERGUSON PARTS

Filtre de cabine - Cab filters - Kabinenfilter - Kabinesfilter - Filtro de cabina



	Ref.	OEM	Dimensions Size Abmessungen Afmetingen Dimensiones
274SK, 284S, 294S, 1014, 1024	30/4200-51	3301748M91	720mmx158mmx55mm

Les références des pièces sont indicatives.
Nos pièces ne sont pas d'origine.



Part numbers are quoted for reference purposes only.
Our parts and accessories are not original.

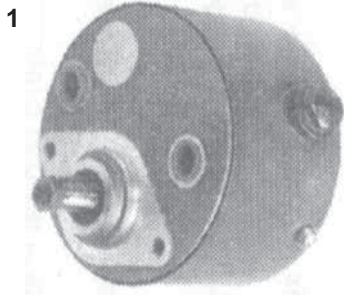

MASSEY-FERGUSON PARTS

Pompe de direction - Steering pump - Lenkungspumpe - Stuurpomp - Bomba de dirección

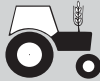

	Fig. Abb. Afb. Fig.	Ref.	OEM	CC	
Industriel 40E, 20F 230, 240, 340, 342, 352, 355, 356, 360	1	30/570-13	1695922M91 3772716M91 3774041M91 3774614M91		
699	2	30/570-31	1693261M91 3903271M91	10	Gauche - Left - Links -Izquierda





Les références des pièces sont indicatives.
Nos pièces ne sont pas d'origine.

Part numbers are quoted for reference purposes only.
Our parts and accessories are not original.



MASSEY-FERGUSON PARTS

Amortisseur de torsion - Torsion damper - Torsiondämpfer - Torsiedemper -
Amortiguador de torsión

	Parts N°	Dimensions	
4245, 4255, 4260, 4265, 4270 (⇒J46101) Powershuttle	30/196-34 (3815739M2)	25Z 38,2 x 41,5	
4225, 4235, 4245, 4255, 4260, 4265, 4270 (J46102⇒) 4325, 4335, 4345, 4355, 4360, 4365, 4370 Powershuttle	30/196-35 (3820069M1)	25Z 38,2 x 41,5	
6485, 6480, 6495, 8210, 8220, 8240, 8250 Dynashift Avec inverseur sous couple With power shuttle Mit hydraulischem Wender Met hydraulische omkeerbak Con inversor automático	30/196-36 (3793648M1)	26Z 39 x 42,5	

Les références des pièces sont indicatives.
Nos pièces ne sont pas d'origine.

Part numbers are quoted for reference purposes only.
Our parts and accessories are not original.



"THE RELIABLE SERVICE"



INDEX INDEX

Alimentation	129
Alternateurs	399-410
Amortisseur de réservoir	121
Amortisseurs de cabine	439
Attelage inférieur - Bras de relevage	391
Avant-train 2 RM	322-334
Balais d'essuie-glace	435
Barres de poussée	388-390
Bielles & pièces connexes	32-40
Boîte de transfert	366
Boîtes à outils	437
Boîtier central	281-282
Bouchons de remplissage d'huile	106
Bougies de préchauffage	116
Boulons et goujons	314-320, 324
Bras de direction	345-348
Câbles d'accélérateurs	123-125
Câbles d'arrêts	123
Câbles d'embrayages	217
Câbles de freins	309-310
Calandres	426
Chauffage de cabine	434
Chemises	43-59
Collecteurs d'échappement	168
Colliers de durite	154
Commande d'embrayage	240
Contacteurs	202-209
Coudes d'échappement	169
Coupleurs hydrauliques	373
Courroies de ventilateur	141-153
Culasses & pièces connexes	61-77
Culbuteurs	78-81
Cylindres de frein	311-313
Décalcomanies	427-428
Démarrateurs	411-423
Différentiel	283-289
Dimensions filtre	189
Direction	335-344
Direction assistée	370
Distributeur hydraulique	381
Distribution	93-105
Durites de filtre à air	190
Durites de pompes à eau	140
Durites de radiateur	155-167
Echappements	170-171
Eclairage	210-216
Embrayage laycock (Pièces de rechange)	237-239
Embrayages	218-236
Équilibreur	112-115
Feux	210-216
Filtration	173-192
Flotteurs de réservoir	194-195
Fourchettes de sélection	270-271
Freins	300-306
Garde-boues	425
Goujons et boulons	314-320
Habillages intérieurs	439
Index	1, 2
Instrumentation	196, 200
Interrupteurs	202-209
Jantes avant	321
Jauges d'huile	107
Jeux de révision moteur	41-42
Jeux de segments	43-59
Jeux de soupapes	60
Jeux semi-finis	53-54

Alternators	399-410
Auxiliary drive	105
Auxiliary Hydraulic pumps	379
Balancer unit	112-115
Bolts	314-320, 324
Brake cables	309-310
Brake cylinders	311-313
Brakes	300-308
Cab dampers	439
Cab glass	440-455
Cab heating	434
Centre housing	281-282
Clutch cables	217
Clutch assemblies & plates	218-236
Clutch control	240
Clutch master and slave cylinders	240
Connecting rods & related parts	32-40
Core plugs	31
Crankshaft & related parts	11-30
Cross references	456-
Cylinder head parts	61-77
Decal sets	427-428
Derivative application chart	9
Differential	283-289
Dipstick	107
Engine gasket sets	82-90
Engine overhaul kits	41-42
Exhaust	168-172
Exhaust elbow	169
Exhaust manifolds	168
Fan blades	154
Fenders	425
Filters	173-193
Flexible drive	201
Flywheel assemblies	232
Front axle (4 WD)	352-365
Front axle (2 WD)	322-334
Front wheels (2 WD)	321
Front grille	426
Fuel pipes	130
Fuel pumps	117-120
Fuel sender units	194-195
Fuel system	129
Fuel tanks and related parts	121-122
Gas struts	430
Gear lever parts	272-274
Glazing rubber and draft excluders	439
Heating plugs	116
Hose clips	154
Hoses (Radiator)	155-167
Hydraulic coupling	373
Hydraulic lift	383-387
Hydraulic lift pumps	374-378
Hydraulic pump spare parts	380
Hydraulic pumps	368-369
Hydraulic spool valves	381
Independent P.T.O. gear	280
Index	1, 2
Injector nozzles	126-128
Interior trims	439
Landini application charts	10
Laycock clutches (Spare parts)	237-239
Levelling box	395-398
Lift isolator valve	382
Lighting	210-216
Liners	43-59

Les références des pièces sont indicatives.
Nos pièces ne sont pas d'origine

Part numbers are quoted for reference purposes only.
Our parts and accessories are not original.



INDEX
INDEX

Joints de moteur	82-90
Joints de vérins de direction - 2RM	371-372
Joints de vérins pour tracteurs industriels	372
Joints pour filtres à combustible	130
Landini (Equivalence)	10
Leviers de vitesses & accessoires	272-274
Loctite®	91-92
Maître-cylindres et cylindre receptrer d'embrayage	240
Manchon d'usure	31
Mécanismes & disques d'embrayage	218-236
Moteurs d'essuie-glace	434
Nez d'injecteur	126-128
Orbitrol	379
Panneaux	424
Pastilles antigel	31
Pédales de frein	308
Peinture	431-433
Pistons de frein	304
Pistons, jeux de segments & chemises	43-59
Pistons, segments & chemises (Cotes reparation)	55
Poignées et serrures	436
Pompe hydraulique (Pièces de rechange)	375-380
Pompes à eau	131-139
Pompes à huile	108-111
Pompes d'alimentation	117-120
Pompes de direction	367
Pompes de relevage hydrauliques internes	374
Pompes hydrauliques	368-369
Pompes hydrauliques auxiliaires	379
Pont arrière	290-299
Pont avant 4RM	352-365
Préfiltres à air	193
Prise de force	275-279
Prise de force indépendante (IPTO)	280
Profilés d'étanchéité pour glaces de cabine	439
Radiateurs & durites	155-164
References interchangeable	456
Relevage hydraulique	383-387
Réservoirs & accessoires	121-122
Rétroviseurs	438
Rotules & tirants de direction	335-344
Segments	43-59
Sièges	429
Soupapes	61-77
Stabilisateurs	392-394
Tableaux d'identification des tracteurs et moteurs	3-8
Thermostats & courroies	141-153
Tirants de relevage	395-398
Tracteurs dérivés (Applicable aux pièces moteur)	9
Transmission	231-268
Transmission flexible	201
Transmission réversible	269
Tringlerie de frein	307
Tuyaux d'alimentation	130
Tuyaux d'extension pour échappements	172
Vanne isolatrice de relevage	382
Ventilateurs	154
Vérins à gaz	430
Vilebrequins & pièces connexes	11-30
Vitrierie de cabine	440-455
Volants moteur	232

Loader & backhoe ram seal kits	372
Locks & handles	436-437
Loctite®	91-92
Lower link arm	391
Mirrors	438
Oil filler cap	106
Oil pumps	108-111
Orbitrol	379
Paint	431-433
Panels	424
Pistons, ring sets & liners	43-59
Power steering	370
PTO	275-279
Radiators & hoses	155-167
Rear axle	290-299
Ring sets	43-59
Rocker shafts & arms	78-81
Seats	429
Selector forks	270-271
Silencers	170-171
Stabilisers	392-394
Starters	411-423
Steering	345-351
Steering cylinder seal kits	371-372
Steering pumps	367
Stop cables	123
Switches	202-209
Tank damper	121
Thermostats & V-belts	141-153
Throttle cables	123-125
Tie rods & sockets	335-344
Timing gear	93-104
Tool boxes	437
Top links	388-390
Tractor and engine application charts	3-8
Transfer gearbox	366
Transmission	241-269
Valvetrain kits	60
V-belts	141-153
Water pumps	131-140
Wear sleeve	31
Wiper blades	435
Wiper motors	434

Les références des pièces sont indicatives.
Nos pièces ne sont pas d'origine



"THE RELIABLE SERVICE"



Part numbers are quoted for reference purposes only.
Our parts and accessories are not original.

TABLEAUX D'IDENTIFICATION DES TRACTEURS ET MOTEURS TRACTOR AND ENGINE APPLICATION CHARTS

Tracteur Tractor	Moteur Engine	Cyl. Cyl.	Alésage Bore mm	Tracteur Tractor	Moteur Engine	Cyl. Cyl.	Alésage Bore mm
Serie TE20 serie				Serie 100 serie			
TEA 20	85mm Petrol	4	85.00	174S	A4.236	4	98.48
TED 20	85mm VO	4	85.00	174V	A4.236	4	98.48
TEF 20	20C	4	80.98	175	A4.236	4	98.48
TEH 20	85mm LO	4	85.00	175S	A4.236	4	98.48
Serie 35 serie				Serie 200 serie			
25	A4.99	4	76.20	230	AD3.152	3	91.49
25	A4.107	4	79.38	233	AD3.152	3	91.49
30	A4.107	4	79.38	234C	AD3.152	3	91.49
FE 35	23C	4	84.14	234CF	AD3.152	3	91.49
35	87mm Petrol	4	87.00	234S	AD3.152	3	91.49
35	A3.144	3	88.92	235	AD3.152	3	91.49
35	A3.152	3	91.49	240	AD3.152	3	91.49
65	A4.192	4	88.92	244CF	AD3.152	3	91.49
65	A4.203	4	91.49	245	AD3.152	3	91.49
65	AD4.203	4	91.49	250	AD3.152	3	91.49
Serie 100 serie				Serie 100 serie			
122	A4.99	4	76.20	253 (Italy)	AD3.152	3	91.49
130	A4.107	4	79.38	253 (UK)	AT3.152.4	3	91.49
133	A3.144	3	88.92	254	AD3.152	3	91.49
133	AD3.152	3	91.49	254C	AD3.152	3	91.49
134C	AD3.152	3	91.49	254CF	AD3.152	3	91.49
134V	AD3.152	3	91.49	254S	AD3.152	3	91.49
135	87mm Petrol	4	87.00	255	AD3.152	3	91.49
135	A3.144	3	88.92	255 (USA)	A4.236	4	98.48
135	AD3.152	3	91.49	260	AD4.203	4	91.49
135	AG3.152	3	91.49	263 (UK)	903.27T	3	95.00
135V	AD3.152	3	91.49	263T (Italy)	AT3.152.4	3	91.49
140	AD3.152	3	91.49	264T	AT3.152.4	3	91.49
145	AD3.152	3	91.49	264TCF	AT3.152.4	3	91.49
145S	AD3.152	3	91.49	264TS	AT3.152.4	3	91.49
145V	AD3.152	3	91.49	265	A4.236	4	98.48
148	AD3.152	3	91.49	273	A4.236	4	98.48
150	AD3.152	3	91.49	274	A4.236	4	98.48
152	AD3.152	3	91.49	274C	A4.236	4	98.48
152F	AD3.152	3	91.49	274CF	A4.236	4	98.48
152S	AD3.152	3	91.49	274S	A4.236	4	98.48
152V	AD3.152	3	91.49	274SK	A4.236	4	98.48
154	AD3.152	3	91.49	275	A4.236	4	98.48
154C	AD3.152	3	91.49	275E	A4.236	4	98.48
154F	AD3.152	3	91.49	275E	A4.41	4	101.05
154S	AD3.152	3	91.49	283	A4.236	4	98.48
154V	AD3.152	3	91.49	284	A4.236	4	98.48
155	AD4.203	4	91.49	284S	A4.236	4	98.48
158	AD4.203	4	91.49	285	A4.248	4	101.05
158F	AD4.203	4	91.49	285 (USA)	A4.318	4	114.31
158S	AD4.203	4	91.49	285 (USA)	A4.318.2	4	114.31
158V	AD4.203	4	91.49	290	A4.248	4	101.05
164TF	AT3.152.4	3	91.49	290E	A4.248	4	101.05
164TS	AT3.152.4	3	91.49	290E	A4.41	4	101.05
164TV	AT3.152.4	3	91.49	293	A4.248	4	101.05
165	AD4.203	4	91.49	294	A4.248	4	101.05
165	A4.212	4	98.48	294C	A4.248	4	101.05
168	A4.236	4	98.48	294S	A4.248	4	101.05
168F	A4.236	4	98.48	298	A4.318.2	4	114.31
168S	A4.236	4	98.48				
174	A4.212	4	98.48				
174	A4.236	4	98.48				
174C	A4.212	4	98.48				
174C	A4.236	4	98.48				
174F	A4.236	4	98.48				

Les références des pièces sont indicatives.
Nos pièces ne sont pas d'origine

Part numbers are quoted for reference purposes only.
Our parts and accessories are not original.



TABLEAUX D'IDENTIFICATION DES TRACTEURS ET MOTEURS TRACTOR AND ENGINE APPLICATION CHARTS

Tracteur Tractor	Moteur Engine	Cyl. Cyl.	Alésage Bore mm	Tracteur Tractor	Moteur Engine	Cyl. Cyl.	Alésage Bore mm
Serie 300 serie				Serie 300 serie			
333	AD3.152	3	91.49	374SP	A4.236	4	98.48
334V	AD3.152	3	91.49	374SP(X)	A4.236 (Blue)	4	98.48
340	AD3.152	3	91.49	374SP(X)	1004.40 (Green)	4	100.00
342	AD3.152	3	91.49	374SQ	A4.236	4	98.48
350	AD3.152	3	91.49	374V	A4.236	4	98.48
352	AT3.152.4	3	91.49	374VQ	A4.236	4	98.48
353	AD3.152	3	91.49	375	A4.236	4	98.48
353LX	AD3.152	3	91.49	375E	A4.236	4	98.48
353S	AD3.152	3	91.49	375E	A4.41	4	101.05
354AP	AD3.152	3	91.49	376C	A4.236	4	98.48
354AQ	AD3.152	3	91.49	376CF	A4.236	4	98.48
354F	AD3.152	3	91.49	376XCF	A4.236	4	98.48
354FP	AD3.152	3	91.49	377	A4.236	4	98.48
354FP(X)	AD3.152	3	91.49	382N	A4.248	4	101.05
354FQ	AD3.152	3	91.49	383	A4.236	4	98.48
354GE	AD3.152	3	91.49	383LX	A4.236	4	98.48
354GE(X)	AD3.152	3	91.49	383S	A4.236	4	98.48
354S	AD3.152	3	91.49	384AP	A4.236	4	98.48
354SP	AD3.152	3	91.49	384AP(X)	A4.236	4	98.48
354SP(X)	AD3.152	3	91.49	384AQ	A4.236	4	98.48
354SQ	AD3.152	3	91.49	384F	A4.236	4	98.48
354V	AD3.152	3	91.49	384FP	A4.236	4	98.48
354VQ	AD3.152	3	91.49	384FP(X)	A4.236	4	98.48
355	AT3.152.4	3	91.49	384FQ	A4.236	4	98.48
356CF	AD3.152	3	91.49	384GE	A4.236	4	98.48
360	AT3.152.4	3	91.49	384GE(X)	A4.236	4	98.48
362	A4.236	4	98.48	384S	A4.236	4	98.48
362N	A4.236	4	98.48	384SP	A4.236	4	98.48
363	AT3.152.4	3	91.49	384SP(X)	A4.236	4	98.48
363LX	AT3.152.4	3	91.49	384SQ	A4.236	4	98.48
363S	AT3.152.4	3	91.49	384V	A4.236	4	98.48
364AP	AT3.152.4	3	91.49	384VQ	A4.236	4	98.48
364AQ	AT3.152.4	3	91.49	387	A4.236	4	98.48
364CF	AT3.152.4	3	91.49	390	A4.248	4	101.05
364F	AT3.152.4	3	91.49	390E	A4.248	4	101.05
364FP	AT3.152.4	3	91.49	390E	A4.41	4	101.05
364FQ	AT3.152.4	3	91.49	390T	AT4.236	4	98.48
364GE	AT3.152.4	3	91.49	393	A4.248	4	101.05
364S	AT3.152.4	3	91.49	393LX	A4.248	4	101.05
364SP	AT3.152.4	3	91.49	393S	A4.248	4	101.05
364SQ	AT3.152.4	3	91.49	393TLX	AT4.236	4	98.48
364V	AT3.152.4	3	91.49	394AP	A4.248	4	101.05
364VQ	AT3.152.4	3	91.49	394AP(X)	A4.248 (Blue)	4	101.05
365	A4.236	4	98.48	394AP(X)	1004.42 (Green)	4	103.00
366CF	AT3.152.4	3	91.49	394AQ	A4.248	4	101.05
367CF	A4.236	4	98.48	394C	A4.248	4	101.05
372N	A4.236	4	98.48	394F	A4.248	4	101.05
373	A4.236	4	98.48	394FP	A4.248	4	101.05
373LX	A4.236	4	98.48	394FP(X)	A4.248 (Blue)	4	101.05
373S	A4.236	4	98.48	394FP(X)	1004.42 (Green)	4	103.00
374AP	A4.236	4	98.48	394FQ	A4.248	4	101.05
374AP(X)	A4.236 (Blue)	4	98.48	394GE	A4.248	4	101.05
374AP(X)	1004.40 (Green)	4	100.00	394GE(X)	A4.248 (Blue)	4	101.05
374AQ	A4.236	4	98.48	394GE(X)	1004.42 (Green)	4	103.00
374F	A4.236	4	98.48	394H	A4.248	4	101.05
374FP	A4.236	4	98.48	394S	A4.248	4	101.05
374FP(X)	A4.236 (Blue)	4	98.48	394SP	A4.248	4	101.05
374FP(X)	1004.40 (Green)	4	100.00	394SP(X)	A4.248 (Blue)	4	101.05
374FQ	A4.236	4	98.48	394SP(X)	1004.42 (Green)	4	103.00
374GE	A4.236	4	98.48	394SQ	A4.248	4	101.05
374GE(X)	A4.236 (Blue)	4	98.48	394TAQ	AT4.236	4	98.48
374GE(X)	1004.40 (Green)	4	100.00	396	1006.6	6	100.00
374H	A4.236	4	98.48	396C	A4.248	4	101.05
374S	A4.236	4	98.48	396CF	A4.248	4	101.05

Les références des pièces sont indicatives.
Nos pièces ne sont pas d'origine

Part numbers are quoted for reference purposes only.
Our parts and accessories are not original.



"THE RELIABLE SERVICE"



TABLEAUX D'IDENTIFICATION DES TRACTEURS ET MOTEURS TRACTOR AND ENGINE APPLICATION CHARTS

Tracteur Tractor	Moteur Engine	Cyl. Cyl.	Alésage Bore mm	Tracteur Tractor	Moteur Engine	Cyl. Cyl.	Alésage Bore mm
Serie 300 serie				Serie 2600 serie			
396CT	AT4.236	4	98.48	2620	A6.354.4	6	98.48
397	A4.248	4	101.05	2625	A6.354.4	6	98.48
397T	AT4.236	4	98.48	2640	A6.354.4	6	98.48
398	AT4.236	4	98.48	2645	A6.354.4	6	98.48
399	A6.354.4	6	98.48	2675	A6.354.4	6	98.48
399	1006.6	6	100.00	2680	AT6.354.4	6	98.48
				2685	AT6.354.4	6	98.48
Serie 500 serie				Serie 2700 serie			
550	AD3.152	3	91.49	2705	AT6.354.4	6	98.48
560	AD4.203	4	91.49	2720	AT6.354.4	6	98.48
565	A4.236	4	98.48	2725	AT6.354.4	6	98.48
575	A4.236	4	98.48				
590	A4.248	4	98.48	Serie 3000 serie			
592	A4.318	4	114.31	3050	A4.236	4	98.48
592	A4.318.2	4	114.31	3055	A4.248	4	101.05
595	A4.318	4	114.31	3060	A4.248	4	101.05
595	A4.318.2	4	114.31	3065	AT4.236	4	98.48
				3065S	AT4.236	4	98.48
Serie 600 serie				3070	AT4.236	4	98.48
675	A4.236	4	98.48	3075	1004.4T	4	100.00
690	A4.248	4	101.05	3080	A6.354.4	6	98.48
698	A4.318.2	4	114.31	3085	1006.6	6	100.00
698T	AT4.236	4	98.48	3090	A6.354.4	6	98.48
699	A6.354.4	6	98.48	3095	1006.6	6	100.00
Serie 700-800 serie				Serie 3100 serie			
765	AD4.203	4	91.49	3115	1006.6	6	100.00
825	A4.107	4	79.38	3120	1006.6T	6	100.00
835	23C	4	84.14	3120T	1006.6T	6	100.00
865	A4.203	4	91.49	3125	1006.6T	6	100.00
				3140	1006.6T	6	100.00
Serie 1000 serie				Serie 3200 & 3300 series			
1004	A4.318.2	4	114.31	3210FP(X)	AD3.152	3	91.49
1004T	AT4.236	4	98.48	3210GE(X)	AD3.152	3	91.49
1007	AT4.236	4	98.48	3210SP(X)	AD3.152	3	91.49
1014	A6.354.1	6	98.48	3220AP(X)	A4.236 (Blue)	4	98.48
1014	A6.354.4	6	98.48	3220AP(X)	1004.40 (Green)	4	100.00
1024	A6.354.4	6	98.48	3220FP(X)	A4.236 (Blue)	4	98.48
1080	A4.318	4	114.31	3220FP(X)	1004.40 (Green)	4	100.00
1085	A4.318	4	114.31	3220GE(X)	A4.236 (Blue)	4	98.48
1100	A6.354	6	98.48	3220GE(X)	1004.40 (Green)	4	100.00
1104	A6.354.1	6	98.48	3220SP(X)	A4.236 (Blue)	4	98.48
1105	ATC6.354.1	6	98.48	3220SP(X)	1004.40 (Green)	4	100.00
1114	A6.354.4	6	98.48	3225AP(X)	A4.236	4	98.48
1130	AT6.354	6	98.48	3225FP(X)	A4.236	4	98.48
1134	AT6.354.4	6	98.48	3225GE(X)	A4.236	4	98.48
1135	AT.6354.1	6	98.48	3225SP(X)	A4.236	4	98.48
1200	A6.354.1	6	98.48	3235AP(X)	A4.248 (Blue)	4	101.05
1250	A6.354.4	6	98.48	3235AP(X)	1004.42 (Green)	4	103.00
				3235FP(X)	A4.248 (Blue)	4	101.05
Serie 2200 serie				3235FP(X)	1004.42 (Green)	4	103.00
2205	AD3.152	3	91.49	3235GE(X)	A4.248 (Blue)	4	101.05
2210	903.27	3	95.00	3235GE(X)	1004.42 (Green)	4	103.00
2220	903.27T	3	95.00	3235SP(X)	A4.248 (Blue)	4	101.05
2230	1004.42	4	103.00	3235SP(X)	1004.42 (Green)	4	103.00
				3315	903.27	3	95.00
				3315F/FE	903.27	3	95.00
				3315GE	903.27	3	95.00
				3315S	903.27	3	95.00

Les références des pièces sont indicatives.
Nos pièces ne sont pas d'origine

Part numbers are quoted for reference purposes only.
Our parts and accessories are not original.



TABLEAUX D'IDENTIFICATION DES TRACTEURS ET MOTEURS TRACTOR AND ENGINE APPLICATION CHARTS

Tracteur Tractor	Moteur Engine	Cyl. Cyl.	Alésage Bore mm	Tracteur Tractor	Moteur Engine	Cyl. Cyl.	Alésage Bore mm
Series 3200 & 3300 series				Serie 4200 serie			
3315V	903.27	3	95.00	4265	1004.40TW	4	100.00
3325	903.27T	3	95.00	4270	1006.6 (Blue)	6	100.00
3325F/FE	903.27T	3	95.00	4270	1006.60T (Green)	6	100.00
3325GE	903.27T	3	95.00	Serie 4300 serie			
3325S	903.27T	3	95.00	4315	903.27	3	95.00
3325V	903.27T	3	95.00	4320	903.27T	3	95.00
3330	1004.40	4	100.00	4325	1004.40	4	100.00
3330F/FE	1004.40	4	100.00	4325HV	1004.40	4	100.00
3330GE	1004.40	4	100.00	4335	1004.42	4	103.00
3330S	1004.40	4	100.00	4335HV	1004.42	4	103.00
3330V	1004.40	4	100.00	4345	1004.40T	4	100.00
3340	1004.42	4	103.00	4345HV	1004.40T	4	100.00
3340F/FE	1004.42	4	103.00	4355	1004.40T	4	100.00
3340GE	1004.42	4	103.00	4355HV	1004.40T	4	100.00
3340S	1004.42	4	103.00	4360	1006.60	6	100.00
3340V	1004.42	4	103.00	4365	1004.40TW	4	100.00
3350	1004.40T	4	100.00	4370	1006.60T	6	100.00
3350F/FE	1004.40T	4	100.00	Serie 6100 serie			
3350GE	1004.40T	4	100.00	6110	A4.41	4	101.05
3350S	1004.40T	4	100.00	6120	A4.41	4	101.05
3355	1004.40T	4	100.00	6130	1004.4T	4	100.00
3355F/FE	1004.40T	4	100.00	6140	1004.4T	4	100.00
3355GE	1004.40T	4	100.00	6150	1004.4T	4	100.00
3355S	1004.40T	4	100.00	6160	1006.6	6	100.00
Serie 3600 serie				6170	1006.6 (Blue)	6	100.00
3610	A6.354.4	6	98.48	6170	1006.60T (Green)	6	100.00
3630	AT6.354.4	6	98.48	6180	1006.6T (Blue)	6	100.00
3635	1006.6T	6	100.00	6180	1006.60T (Green)	6	100.00
3645	1006.6T	6	100.00	6190	1006.6T	6	100.00
3650	AT6.354.4	6	98.48	Serie 6200 serie			
3655	1006.6T	6	100.00	6235	1004.40T	4	100.00
3660	1006.6T	6	100.00	6235HV	1004.40T	4	100.00
3670	620DS	6	108.00	6245	1004.40T	4	100.00
3680	612DS	6	108.00	6245HV	1004.40T	4	100.00
3690	612DS	6	108.00	6255	1004.40T	4	100.00
3690	634DS	6	108.00	6255HV	1004.40T	4	100.00
Serie 4200 serie				6260	1006.60	6	100.00
4215	903.27	3	95.00	6265	1004.40TW	4	100.00
4220	903.27T	3	95.00	6270	1006.60T	6	100.00
4225	A4.41 (Blue)	4	101.05	6280	1006.60T	6	100.00
4225	1004.40 (Green)	4	100.00	6290	1006.60T	6	100.00
4225HV	A4.41 (Blue)	4	101.05	Serie 8100 serie			
4225HV	1004.40 (Green)	4	100.00	8110	1006.6T	6	100.00
4235	A4.41 (Blue)	4	101.05	8120	1006.6T (Blue)	6	100.00
4235	1004.40T (Green)	4	100.00	8120	1006.60T (Green)	6	100.00
4235 (USA)	1004.42 (Green)	4	103.00	8130	1006.6T	6	100.00
4235HV	A4.41 (Blue)	4	101.05	8140	620DS	6	108.00
4235HV	1004.40T (Green)	4	100.00	8150	620DS	6	108.00
4235HV (USA)	1004.42 (Green)	4	103.00	8160	634DS	6	108.00
4240	A4.41	4	101.05	8170	645DSBIE	6	111.00
4245	1004.4T (Blue)	4	100.00	8180	645DSBIE	6	111.00
4245	1004.40T (Green)	4	100.00				
4245HV	1004.4T (Blue)	4	100.00				
4245HV	1004.40T (Green)	4	100.00				
4255	1004.4T (Blue)	4	100.00				
4255	1004.40T (Green)	4	100.00				
4255HV	1004.4T (Blue)	4	100.00				
4255HV	1004.40T (Green)	4	100.00				
4260	1006.6 (Blue)	6	100.00				
4260	1006.60 (Green)	6	100.00				

Les références des pièces sont indicatives.
Nos pièces ne sont pas d'origine

Part numbers are quoted for reference purposes only.
Our parts and accessories are not original.



"THE RELIABLE SERVICE"



TABLEAUX D'IDENTIFICATION DES TRACTEURS ET MOTEURS TRACTOR AND ENGINE APPLICATION CHARTS

Tracteur <i>Tractor</i>	Moteur <i>Engine</i>	Cyl. <i>Cyl.</i>	Alésage <i>Bore mm</i>		Tracteur <i>Tractor</i>	Moteur <i>Engine</i>	Cyl. <i>Cyl.</i>	Alésage <i>Bore mm</i>
Serie 8200 serie					Tracteurs industriels / Industrial tractors			
8210	1006.60T	6	100.00		50C	A4.236	4	98.48
8220	1006.60T	6	100.00		50D	A4.236	4	98.48
8240	620DSRAE	6	108.00		50E	A4.236	4	98.48
8240XTRA	620DWBAE	6	108.00		50EX	A4.248	4	101.05
8250	634DSBAE	6	108.00		50H	A4.236	4	98.48
8250XTRA	634DWBAE	6	108.00		50H-S	A4.236	4	98.48
8260	634DSBAE	6	108.00		50H-T	A4.236	4	98.48
8260	634DSBIE	6	108.00		50HX	A4.248	4	101.05
8260XTRA	634DWBAE	6	108.00		50HX-S	A4.248	4	101.05
8270	645DSBIE	6	111.00		50HX-T	A4.248	4	101.05
8270XTRA	645DSBAE	6	111.00		60	A4.236	4	98.48
8280	645DSBIE	6	111.00		60H	A4.248	4	101.05
8280XTRA	645DSBAE	6	111.00		60H-S	A4.248	4	101.05
Chargeurs télescopiques / Telescopic handlers					60HX	AT4.236	4	98.48
24	A4.236	4	98.48		60HX-T	AT4.236	4	98.48
24T	AT4.236	4	98.48		70	A4.318	4	114.31
8925	1004.4 (Blue)	4	100.00		203	A3.152	3	91.49
8925	1004.42 (Green)	4	100.00		203	AD3.152	3	91.49
8925T	1004.4T (Blue)	4	100.00		205	A3.152	3	91.49
8925T	1004.40T (Green)	4	100.00		205	AD3.152	3	91.49
8926	1004.4 (Blue)	4	100.00		302	AD4.203	4	91.49
8926	1004.42 (Green)	4	100.00		304	AD4.203	4	91.49
8926T	1004.4T (Blue)	4	100.00		356	A4.203	4	91.49
8926T	1004.40T (Green)	4	100.00		356	AD4.203	4	91.49
8937	1004.4 (Blue)	4	100.00		702	23C	4	84.14
8937	1004.42 (Green)	4	100.00		2135	AD3.152	3	91.49
8937T	1004.4T (Blue)	4	100.00		2203	AD3.152	3	91.49
8937T	1004.40T (Green)	4	100.00		2205	AD3.152	3	91.49
8939	1004.4 (Blue)	4	100.00		3165	AD4.203	4	91.49
8939	1004.42 (Green)	4	100.00		3303	AD4.203	4	91.49
8939T	1004.4T (Blue)	4	100.00		3303	A4.212	4	98.48
8939T	1004.40T (Green)	4	100.00		3305	AD4.203	4	91.49
Tracteurs industriels / Industrial tractors					3305	A4.212	4	98.48
Tracteurs industriels MF / MF Industrial (⇔ 1992)					Farmac & Terex (1993 ⇔)			
20	AG3.152	3	91.49		750	1004.4 (Blue)	4	100.00
20	AD3.152	3	91.49		750	1004.42 (Green)	4	103.00
20B	AD3.152	3	91.49		750B	1004.42	4	103.00
20C	AD3.152	3	91.49		760	1004.4T (Blue)	4	100.00
20D	AD3.152	3	91.49		760	1004.40T (Green)	4	100.00
20E	AD3.152	3	91.49		760B	1004.40T	4	100.00
20F	AD3.152	3	91.49		860	1004.4T (Blue)	4	100.00
30	AD4.203	4	91.49		860	1004.40T (Green)	4	100.00
30B	AD3.152	3	91.49		860B	1004.40T	4	100.00
30D	A4.236	4	98.48		860S	1004.4T (Blue)	4	100.00
30E	AD3.152	3	91.49		860S	1004.40T (Green)	4	100.00
30H	AD3.152	3	91.49		860SE	1004.4T (Blue)	4	100.00
40	AG3.152	3	91.49		860SE	1004.40T (Green)	4	100.00
40	AD3.152	3	91.49		865	1004.4T	4	100.00
40B	AD4.203	4	91.49		960	1004.4T (Blue)	4	100.00
40E	AT3.152.4	3	91.49		960	1004.40T (Green)	4	100.00
50	AD4.203	4	91.49		960B	1004.40T	4	100.00
50	A4.212	4	98.48		965	1004.4T (Blue)	4	100.00
50	A4.236	4	98.48		965	1004.40T (Green)	4	100.00
50B	A4.212	4	98.48					
50B	A4.236	4	98.48					
50B Mk11	A4.236	4	98.48					

Les références des pièces sont indicatives.
Nos pièces ne sont pas d'origine

Part numbers are quoted for reference purposes only.
Our parts and accessories are not original.



TABLEAUX D'IDENTIFICATION DES TRACTEURS ET MOTEURS TRACTOR AND ENGINE APPLICATION CHARTS

Tracteur <i>Tractor</i>	Moteur <i>Engine</i>	Cyl. <i>Cyl.</i>	Alésage <i>Bore mm</i>	Tracteur <i>Tractor</i>	Moteur <i>Engine</i>	Cyl. <i>Cyl.</i>	Alésage <i>Bore mm</i>
Moissonneuses-Batteuses / Combines				Moissonneuses-Batteuses / Combines			
8 Plot	A4.236	4	98.48	535	A6.354.4	6	98.48
10 Plot	A4.236	4	98.48	560	AT6.354.4	6	98.48
16 Plot	A4.236	4	98.48	565	AT6.354.4	6	98.48
16	A4.236	4	98.48	620	A6.372	6	101.05
20	A4.248	4	101.05	625	A6.372	6	101.05
20XP	AT4.236	4	98.48	660	AT6.354.4	6	98.48
24	A6.354.4	6	98.48	665	AT6.354.4	6	98.48
27	AT6.354.4	6	98.48	740	A6.372	6	101.05
29	AT6.354.4	6	98.48	750	A6.372	6	101.05
29XP	AT6.354.4	6	98.48	750	A6.372.4	6	101.05
31	AT6.354.4	6	98.48	750	AT6.354.1	6	98.48
31XP	AT6.354.4	6	98.48	750	AT6.354.4	6	98.48
99	A4.236	4	98.48	760	AT6.354.1	6	98.48
186	A4.212	4	98.48	760	AT6.354.4	6	98.48
187	A4.236	4	98.48	788	A4.270	4	107.95
206	A4.236	4	98.48	800	A6.354.4	6	98.48
240	A4.236	4	98.48	805	A6.354.4	6	98.48
307	A4.236	4	98.48	810	A6.354.4	6	98.48
330	A4.236	4	98.48	815	A6.354.4	6	98.48
400	A4.300	4	114.30	820	AT6.354.4	6	98.48
410	A4.300	4	114.30	825	AT6.354.4	6	98.48
415	A4.300	4	114.30	830	AT6.354.4	6	98.48
430	A4.248	4	101.05	835	AT6.354.4	6	98.48
440	A4.248	4	101.05	840	AT6.354.4	6	98.48
487	A4.248	4	101.05	845	AT6.354.4	6	98.48
500	A6.354	6	98.48	850	AT6.354.4	6	98.48
506	A4.248	4	101.05	855	AT6.354.4	6	98.48
507	A6.354	6	98.48	860	AT6.354.4	6	98.48
510	A6.354	6	98.48				
515	A6.354	6	98.48				
520	A6.354	6	98.48				
525	A6.354	6	98.48				
530	A6.354.4	6	98.48				
530S	A6.354.4	6	98.48				

Les références des pièces sont indicatives.
Nos pièces ne sont pas d'origine

Part numbers are quoted for reference purposes only.
Our parts and accessories are not original.



LISTE DES DERIVES (APPLICABLE AUX PIECES MOTEUR) DERIVATIVE APPLICATION CHART (APPROPRIATE TO ENGINE PARTS)

Tracteur Tractor	Moteur Engine	Dérivés Derivatives	Tracteur Tractor	Moteur Engine	Dérivés Derivatives
Moteurs 3 cyl. / 3 cyl. engines			Moteurs 4 cyl. / 4 cyl. engines		
134	AD3.152	134C, 134V	384	A4.236	384AP, 384AP(X), 384AQ, 384F, 384FP, 384FP(X), 384FQ, 384GE, 384GE(X), 384S, 384SP, 384SP(X), 384SQ, 384V, 384VQ
135	AD3.152	135V			
145	AD3.152	145S, 145V	393	A4.28	393LX, 393S
152	AD3.152	152F, 152S, 152V	394	A4.248 (Blue)	394AP, 394AP(X), 394AQ, 394C, 394F, 394FP, 394FP(X), 394FQ, 394GE, 394GE(X), 394H, 394S, 394SP, 394SP(X), 394SQ
154	AD3.152	154C, 154F, 154S, 152V			
164T	AT3.152.4	164TF, 164TS, 164TV	394	1004.42 (Green)	394AP(X), 394FP(X), 394GE(X), 394SP(X)
234	AD3.152	234C, 234CF, 234S	396C	A4.248	396CF
254	AD3.152	254C, 254CF, 254S	3220	A4.236 (Blue)	3220AP(X), 3220FP(X), 3220GE(X), 3220SP(X)
264T	AT3.152.4	264TCF, 264TS	3220	1004.40 (Green)	3220AP(X), 3220FP(X), 3220GE(X), 3220SP(X)
353	AD3.152	353LX, 353S	3225	A4.236	3225AP(X), 3225FP(X), 3225GE(X), 3225SP(X)
354	AD3.152	354AP, 354AQ, 354F, 354FP, 354FP(X), 354FQ, 354GE, 354GE(X), 354S, 354SP, 354SP(X), 354SQ, 354V, 354VQ	3235	A4.248 (Blue)	3235AP(X), 3235FP(X), 3235GE(X), 3235SP(X)
363	AT3.152.4	363LX, 363S	3235	1004.42 (Green)	3235AP(X), 3235FP(X), 3235GE(X), 3235SP(X)
364	AT3.152.4	364AP, 364AQ, 364CF, 364F, 364FP, 364FQ, 364GE, 364S, 364SP, 364SQ, 364V, 364VQ	3330	1004.40	3330F/FE, 3330GE, 3330S, 3330V
3210	AD3.152	3210FP(X), 3210GE(X), 3210SP(X)	3340	1004.42	3340F/FE, 3340GE, 3340S, 3340V
3315	903.27	3315F/FE, 3315GE, 3315S, 3315V	3350	1004.40T	3350F/FE, 3350GE, 3350S
3325	903.27T	3325F/FE, 3325GE, 3325S, 3325V	3355	1004.40T	3355F/FE, 3350GE, 3355S
Moteurs 4 cyl. / 4 cyl. engines			4225	A4.41 (Blue)	4225HV
158 MKIII	AD4.203	158F, 158S, 158V	4225	1004.40 (Green)	4225HV
168 MKIII	A4.236	168F, 168S	4235	A4.41 (Blue)	4235HV
174	A4.212	174C	4235	1004.40 (Green)	4235HV
174	A4.236	174C, 174F, 174S, 174V	4235 (USA)	1004.42 (Green)	4235HV (USA)
175	A4.236	175S	4245	1004.4T (Blue)	4245HV
184	A4.236	184F, 194S	4245	1004.40T (Green)	4245HV
194	A4.248	194C, 194F, 194S	4255	1004.4T (Blue)	4255HV
274	A4.236	274C, 274CF, 274S, 274SK	4255	1004.40T (Green)	4255HV
284	A4.236	284S	4325	1004.40	4325HV
294	A4.248	294C, 294S	4335	1004.42	4335HV
373	A4.236	373LX, 373S	4345	1004.40T	4345HV
374	A4.236 (Blue)	374AP, 374AP(X), 374AQ, 374F, 374FP, 374FP(X), 374FQ, 374GE, 374GE(X), 374H, 374S, 374SP, 374SP(X), 374SQ, 374V, 374VQ	4355	1004.40T	4355HV
374	1004.40 (Green)	374AP(X), 374FP(X), 374GE(X), 374SP(X)	6235	1004.40T	6235HV
376C	A4.236	376CF, 376XCF	6245	1004.40T	6245HV
383	A4.236	383LX, 383S	6255	1004.40T	6255HV

La liste des dérivés est uniquement applicable pour les pièces moteurs

Derivative list is only appropriate to the engine parts section

Les références des pièces sont indicatives.
 Nos pièces ne sont pas d'origine

Part numbers are quoted for reference purposes only.
 Our parts and accessories are not original.



LISTE DES CORRESPONDANCES LANDINI LANDINI APPLICATION CHARTS

Landini Landini	MF MF	Moteur Engine	Cyl. Cyl.	Alésage Boring	Landini Landini	MF MF	Moteur Engine	Cyl. Cyl.	Alésage Boring
50 Blizzard	353LX	AD3.152	3	91.49	C5830	254C	AD3.152	3	91.49
55 F	354FQ	AD3.152	3	91.49	CF5830	254CF	AD3.152	3	91.49
55 FP	354FP	AD3.152	3	91.49	5840	254	AD3.152	3	91.49
55 GE	354GE	AD3.152	3	91.49	5860	353	AD3.152	3	91.49
55 GT	354AQ	AD3.152	3	91.49	5870	353S	AD3.152	3	91.49
55 GTP	354AP	AD3.152	3	91.49	6030	263T	AT3.152.4	3	91.49
55 L	354SQ	AD3.152	3	91.49	6030F	164TF	AT3.152.4	3	91.49
55 LP	354SP	AD3.152	3	91.49	6030L	164TS	AT3.152.4	3	91.49
55 V	354VQ	AD3.152	3	91.49	6030V	164TV	AT3.152.4	3	91.49
CF 55	356CF	AD3.152	3	91.49	CF6030	264TCF	AT3.152.4	3	91.49
60 Blizzard	363LX	AT3.152.4	3	91.49	6040	264T	AT3.152.4	3	91.49
60 F	364FQ	AT3.152.4	3	91.49	6060	363	AT3.152.4	3	91.49
60 FP	364FP	AT3.152.4	3	91.49	6060F	364F	AT3.152.4	3	91.49
60 GE	364GE	AT3.152.4	3	91.49	6060L	364S	AT3.152.4	3	91.49
60 GT	364AQ	AT3.152.4	3	91.49	6060V	364V	AT3.152.4	3	91.49
60 GTP	364AP	AT3.152.4	3	91.49	6070	363S	AT3.152.4	3	91.49
60 L	364SQ	AT3.152.4	3	91.49	6500	174	A4.236	4	98.48
60 LP	364SP	AT3.152.4	3	91.49	C6500	174C	A4.236	4	98.48
60 V	364VQ	AT3.152.4	3	91.49	6530F	174F	A4.236	4	98.48
CF 60	364CF	AT3.152.4	3	91.49	6530L	174S	A4.236	4	98.48
65 Blizzard	373LX	A4.236	4	98.48	6530V	174V	A4.236	4	98.48
65 F	374FQ	A4.236	4	98.48	6550	274SK	A4.236	4	98.48
65 FP	374FP	A4.236	4	98.48	6560F	374F	A4.236	4	98.48
65 GE	374GE	A4.236	4	98.48	6560L	374S	A4.236	4	98.48
65 GT	374AQ	A4.236	4	98.48	6560V	374V	A4.236	4	98.48
65 GTP	374AP	A4.236	4	98.48	6830	273	A4.236	4	98.48
65 L	374SQ	A4.236	4	98.48	C6830	274C	A4.236	4	98.48
65 LP	374SP	A4.236	4	98.48	CF6830	274CF	A4.236	4	98.48
65 V	374VQ	A4.236	4	98.48	6840	274	A4.236	4	98.48
75 Blizzard	383LX	A4.236	4	98.48	6860	373	A4.236	4	98.48
75 F	384FQ	A4.236	4	98.48	6870	373S	A4.236	4	98.48
75 FP	384FP	A4.236	4	98.48	6880	377	A4.236	4	98.48
75 GE	384GE	A4.236	4	98.48	7500	184	A4.236	4	98.48
75 GT	384AQ	A4.236	4	98.48	7530F	184F	A4.236	4	98.48
75 GTP	384AP	A4.236	4	98.48	7530L	184S	A4.236	4	98.48
75 L	384SQ	A4.236	4	98.48	7550	284S	A4.236	4	98.48
75 LP	384SP	A4.236	4	98.48	7560F	384F	A4.236	4	98.48
75 V	384VQ	A4.236	4	98.48	7560L	384S	A4.236	4	98.48
C 75	376C	A4.236	4	98.48	7560V	384V	A4.236	4	98.48
CF 75	376CF	A4.236	4	98.48	C7800	194C	A4.248	4	101.05
85 Blizzard	393LX	A4.248	4	101.05	7830	283	A4.236	4	98.48
85 F	394FQ	A4.248	4	101.05	C7830	294C	A4.248	4	101.05
85 FP	394FP	A4.248	4	101.05	7860	383	A4.236	4	98.48
85 GE	394GE	A4.248	4	101.05	7870	383S	A4.236	4	98.48
85 GT	394AQ	A4.248	4	101.05	7880	387	A4.236	4	98.48
85 GTP	394AP	A4.248	4	101.05	8500	194	A4.248	4	101.05
85 L	394SQ	A4.248	4	101.05	8500	294	A4.248	4	101.05
85 LP	394SP	A4.248	4	101.05	8530F	194F	A4.248	4	101.05
C 85	396C	A4.248	4	101.05	8530L	194S	A4.248	4	101.05
CF 85	396CF	A4.248	4	101.05	8550	294S	A4.248	4	101.05
95 GT	394TAQ	AT4.236	4	98.48	8560F	394F	A4.248	4	101.05
C 95	396CT	AT4.236	4	98.48	8560L	394S	A4.248	4	101.05
C4500	134C	AD3.152	3	91.49	8830	293	A4.248	4	101.05
4530V	134V	AD3.152	3	91.49	8860	393	A4.248	4	101.05
4560V	334V	AD3.152	3	91.49	C8860	394C	A4.248	4	101.05
C4830	234C	AD3.152	3	91.49	8880	397	A4.248	4	101.05
CF4830	234CF	AD3.152	3	91.49	9080	397T	AT4.236	4	98.48
CF5030	244CF	AD3.152	3	91.49	9500	1104	A6.354.1	6	98.48
5500	154	AD3.152	3	91.49	9880	1007	AT4.236	4	98.48
C5500	154C	AD3.152	3	91.49	10000	1014	A6.354.1	6	98.48
5530F	154F	AD3.152	3	91.49	10000S	1014	A6.354.4	6	98.48
5530L	154S	AD3.152	3	91.49	12500	1114	A6.354.4	6	98.48
5530V	154V	AD3.152	3	91.49	13000	1024	A6.354.4	6	98.48
5560F	354F	AD3.152	3	91.49	14500	1134	AT6.354.4	6	98.48
5560L	354S	AD3.152	3	91.49	16000	2720	AT6.354.4	6	98.48
5560V	354V	AD3.152	3	91.49	16500	2725	AT6.354.4	6	98.48
5830	253	AD3.152	3	91.49					

Les références des pièces sont indicatives.
Nos pièces ne sont pas d'origine



"THE RELIABLE SERVICE"



Part numbers are quoted for reference purposes only.
Our parts and accessories are not original.

MF-10

Ed.1 (07/04)

VILEBREQUINS & PIÈCES CONNEXES
CRANKSHAFT & RELATED PARTS

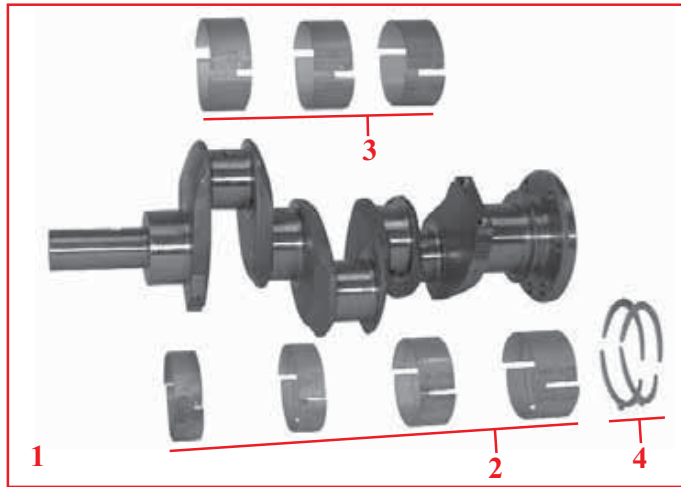

		1		2	3	4
Tracteurs Tractors	Moteur Engine	Jeu vilebrequin Crankshaft kit		Couss. de palier Main bear. set	Couss. de bielle Conrod bear. set	Jeu d'épaisseur lat. Thrust washer kit
3 Moteurs 3 cylindres / 3 cylinder engines						
35, 133, 135	A3.144	Type A 30/1-1 (ZZ90148, 4222037M91)	Type B 30/1-5 (ZZ90150, 3641858M91)	30/2-1 (68084, 746156M91)	30/3-1 (85036, 737070M91)	30/6-1 (Std) (U5TW0003)
35	A3.152					
133, 134, 135, 140, 145, 148, 150, 152, 154, 233, 253 (Italy), 254	AD3.152					
135	AG3.152	30/1-5 (ZZ90150, 3641858M91)		30/2-76 (U5MB0008, 3637501M91)	30/3-76 (U5ME0005, 3637509M91)	
230, 234, 235, 240, 244CF, 245, 250, 255, 333, 334V, 340, 342, 350, 353, 354, 356CF, 550, 2205, 3210	AD3.152	30/1-26 (ZZ90151, 3641825M91)				
164T, 253 (UK), 263T (Italy), 264T, 352, 355 360 (CN31187)	AT3.152.4			30/2-77 (U5MB0014, 4222571M91)	30/3-1 (85036, 737070M91)	
360 (CN31185), 363, 364, 366CF	AT3.152.4					
2210	903.27	30/1-77 (ZZ90179, 4223807M91)		30/3-76 (U5ME0005, 3637509M91)		
3315, 4215, 4315		30/1-78 (ZZ90183, 4222721M91)				
263 (UK), 2220, 3325, 4220, 4320	903.27T					

Les coussinets de palier et de bielle sont disponibles en cote réparation 0.010"- 0.020"- 0.030". Ajouter respectivement les suffixes A, B, ou C. 0.040"- 0.050"- 0.060" sur demande.

Main and conrod bearing sets are available in 0.010"- 0.020"- 0.030" undersize. Please add the suffix A, B, or C respectively. 0.040"- 0.050"- 0.060" on request.

Les épaisseurs latérales sont disponibles individuellement. Voir page MF-19.
Top and bottom thrust washers are available separately. See page MF-19.

Type A : Bague arr. 2 pièces / Rope seal
Type B : Bague arr. 1 pièce / Lip seal

Les références des pièces sont indicatives.
Nos pièces ne sont pas d'origine

Part numbers are quoted for reference purposes only.
Our parts and accessories are not original.



VILEBREQUINS & PIÈCES CONNEXES
CRANKSHAFT & RELATED PARTS

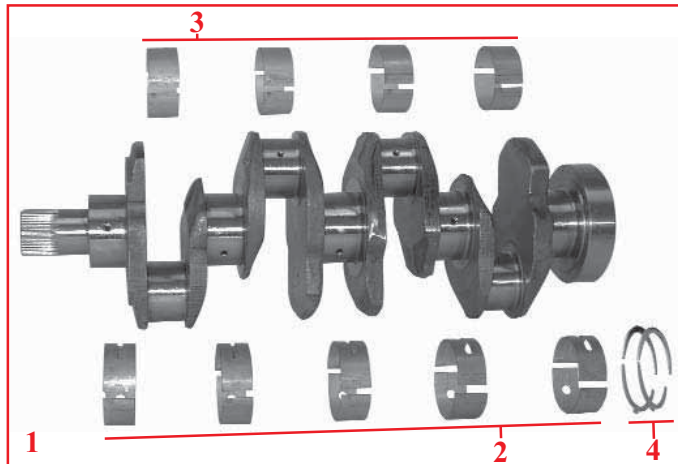

Tracteurs <i>Tractors</i>	Moteur <i>Engine</i>	1 Jeu vilebrequin <i>Crankshaft kit</i>		2 Couss. de palier <i>Main bear. set</i>	3 Couss. de bielle <i>Conrod bear. set</i>	4 Jeu d'épaisseur lat. <i>Thrust washer kit</i>
4 Moteurs 4 cylindres / 4 cylinder engines						
TEA20 TED20 TEH20 35, 135	85mm Petrol 85mm VO 85mm LO 87mm Petrol			30/2-18 (554320M91)	30/3-18 (1810083M91)	30/6-13 (B613)
TEF20	20C Diesel			30/2-20 (830897M91)	30/3-19 (894923M91)	
FE35, 835	23C Diesel				30/3-20 (830899M91)	
25, 122 25, 30, 130, 825	A4.99 A4.107			30/2-10 (84992, 737239M91)	30/3-10 (85037, 736915M91)	
65 65, 865 65, 155, 158, 165, 765	A4.192 A4.203 AD4.203	Type A 30/1-2 (ZZ90121, 3638473M91)	Type B 30/1-34 (ZZ90111, 3637458M91)	30/2-2 (68082, 745405M91)	30/3-2 (85035, 737066M91)	30/6-1 (Std) (U5TW0003)
158MKIII, 260, 560	AD4.203	30/1-34 (ZZ90111, 3637458M91)				30/6-2 (+ 0.19mm) (U5TW0003B)
165, 174	A4.212			30/2-3 (81558, 735168M91)	30/3-3 (85042, 736950M91)	30/6-3 (Std) (U5TW0002)
168, 174, 175, 184, 255 (USA), 178, 185, 188, 194	A4.236 A4.248	Type A 30/1-4 (ZZ90093, 3639541M1)	Type B 30/1-7 (ZZ90081, 3637401M91)			30/6-4 (+ 0.19mm) (U5TW0002B)

Les coussinets de palier et de bielle sont disponibles en cote réparation 0.010"- 0.020"- 0.030". Ajouter respectivement les suffixes A, B, ou C. 0.040"- 0.050"- 0.060" sur demande.

Main and conrod bearing sets are available in 0.010"- 0.020"- 0.030" undersize. Please add the suffix A, B, or C respectively. 0.040"- 0.050"- 0.060" on request.

Les épaisseurs latérales sont disponibles individuellement. Voir page MF-19.
Top and bottom thrust washers are available separately. See page MF-19.

Type A : Bague arr. 2 pièces / *Rope seal*
Type B : Bague arr. 1 pièce / *Lip seal*

Les références des pièces sont indicatives.
Nos pièces ne sont pas d'origine

Part numbers are quoted for reference purposes only.
Our parts and accessories are not original.



VILEBREQUINS & PIÈCES CONNEXES
CRANKSHAFT & RELATED PARTS

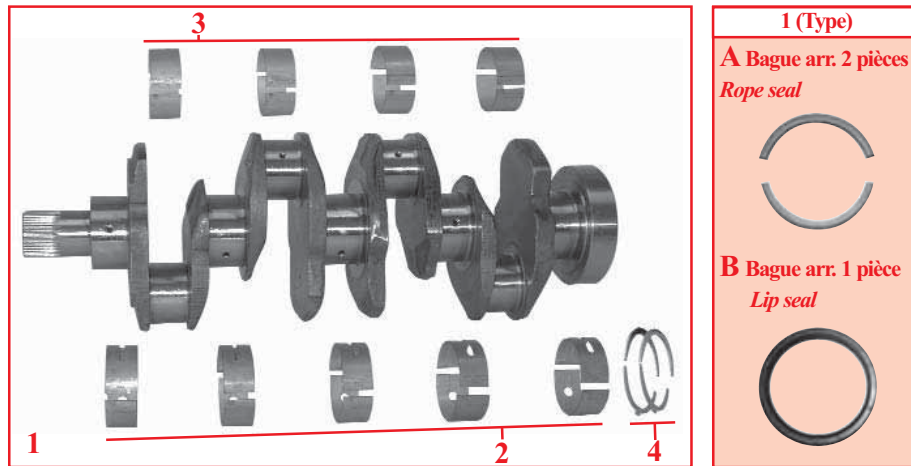

		1	2	3	4
Tracteurs Tractors	Moteur Engine	Jeu vilebrequin Crankshaft kit	Couss. de palier Main bear. set	Couss. de bielle Conrod bear. set	Jeu d'épaisseur lat. Thrust washer kit
Moteurs 4 cylindres / 4 cylinder engines					
168MKIII, 265, 275, 565, 575 273, 274 (LD22573, LD22813) 283, 284 (LD22574, LD22756) 675 (LD31096, LD31097)		30/1-8 (C) (ZZ90082, 3637402M91)			
273, 274 (LD31174, LD31175) 283, 284 (LD31172, LD31173) 275E, 362, 362N, 365, 367CF, 372N, 373, 374, 375, 375E, 376C, 377, 383, 384, 387 675 (LD31110) 3050, 3220, 3225	A4.236	30/1-7 (C) (ZZ90081, 3637401M91)	30/2-3 (81558, 735168M91)	30/3-3 (85042, 736950M91)	30/6-3 (Std) (U5TW0002)
390T, 393TLX, 394TAQ, 396CT, 397T, 398, 698T, 1004T, 1007, 3065, 3065S, 3070	AT4.236	30/1-8 (C) (ZZ90082, 3637402M91)			30/6-4 (+ 0.19mm) (U5TW0002B)
285, 290, 290E, 382N, 390, 390E, 590, 690, 3055, 3060 293, 294 (LF22575, LF22762)	A4.248	30/1-7 (C) (ZZ90081, 3637401M91)			
293, 294 (LF31176, LF31177) 393, 394, 396C, 397, 3235					
285 (USA), 592, 595, 1080, 1085	A4.318		30/2-11 (68085, 745584M91)	30/3-11 (85041, 736878M91)	
285 (USA), 298, 592, 595, 698, 1004	A4.318.2				

(C) Vérifier le vilebrequin adéquat selon le numéro de liste de construction. 30/1-8 a des masses d'équilibrage sur le vilebrequin, 30/1-7 pas.
Check which crankshaft is required as it is dependent on the engine build list. 30/1-8 has balancer weights incorporated in the web of the crankshaft whereas 30/1-7 has not.

Les coussinets de palier et de bielle sont disponibles en cote réparation 0.010"- 0.020"- 0.030". Ajouter respectivement les suffixes A, B, ou C. 0.040"- 0.050"- 0.060" sur demande.
Main and conrod bearing sets are available in 0.010"- 0.020"- 0.030" undersize. Please add the suffix A, B, or C respectively. 0.040"- 0.050"- 0.060" on request.

Les épaisseurs latérales sont disponibles individuellement. Voir page MF-19.
Top and bottom thrust washers are available separately. See page MF-19.

Les références des pièces sont indicatives.
Nos pièces ne sont pas d'origine

Part numbers are quoted for reference purposes only.
Our parts and accessories are not original.



"THE RELIABLE SERVICE"



VILEBREQUINS & PIÈCES CONNEXES
CRANKSHAFT & RELATED PARTS

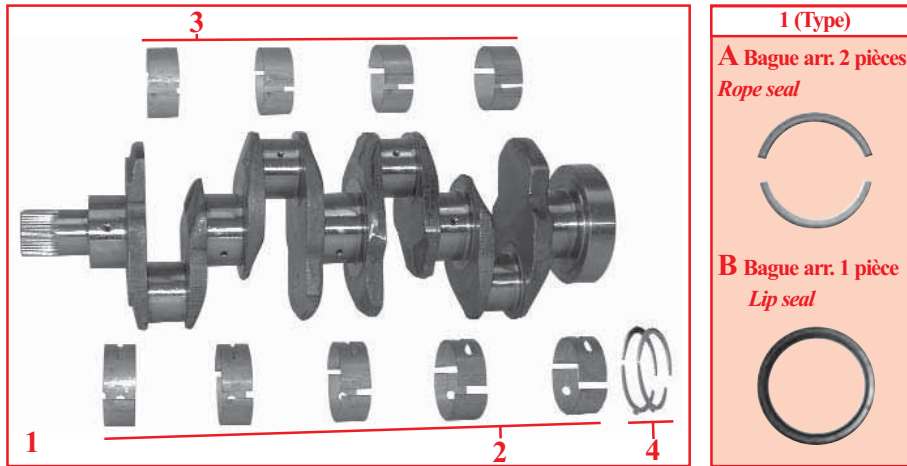

		1	2	3	4
Tracteurs Tractors	Moteur Engine	Jeu vilebrequin Crankshaft kit	Couss. de palier Main bear. set	Couss. de bielle Conrod bear. set	Jeu d'épaisseur lat. Thrust washer kit
4 Moteurs 4 cylindres / 4 cylinder engines					
275E, 290E, 375E, 390E, 6110, 6120	A4.41 (Blue)	30/1-73 (ZZ90143, 3641031M91)	30/2-3 (81558, 735168M91)	30/3-3 (85042, 736950M91)	30/6-3 (Std) (U5TW0002)
4225, 4235, 4240		30/1-7 (ZZ90081, 3637401M91)		30/3-28 (U5ME0006, 3637791M91)	
374, 3220	1004.40 (Green)	30/1-42 (ZZ90202, 4223939M91)		30/3-3 (85042, 736950M91)	
3330, 4225, 4325		30/1-73 (ZZ90143, 3641031M91)		30/6-4 (+ 0.19mm) (U5TW0002B)	
394, 2230, 3235, 4235 (USA), 4335	1004.42 (Green)	30/1-42 (ZZ90202, 4223939M91)		30/3-28 (U5ME0006, 3637791M91)	
3340		30/1-73 (ZZ90143, 3641031M91)		30/3-3 (85042, 736950M91)	
3075, 4245, 4255, 6130, 6140, 6150	1004.4T (Blue)	30/1-42 (ZZ90202, 4223939M91)		30/3-28 (U5ME0006, 3637791M91)	
3350, 3355, 4235, 4245, 4255, 4345, 4355, 6235, 6245, 6255	1004.40T (Green)				
4265, 4365, 6265	1004.40TW				

Les coussinets de palier et de bielle sont disponibles en cote réparation 0.010"- 0.020"- 0.030". Ajouter respectivement les suffixes A, B, ou C. 0.040"- 0.050"- 0.060" sur demande.

Main and conrod bearing sets are available in 0.010"- 0.020"- 0.030" undersize. Please add the suffix A, B, or C respectively: 0.040"- 0.050"- 0.060" on request.

Les épaisseurs latérales sont disponibles individuellement. Voir page MF-19.
Top and bottom thrust washers are available separately. See page MF-19.

Les références des pièces sont indicatives.
Nos pièces ne sont pas d'origine

Part numbers are quoted for reference purposes only.
Our parts and accessories are not original.



VILEBREQUINS & PIÈCES CONNEXES
CRANKSHAFT & RELATED PARTS

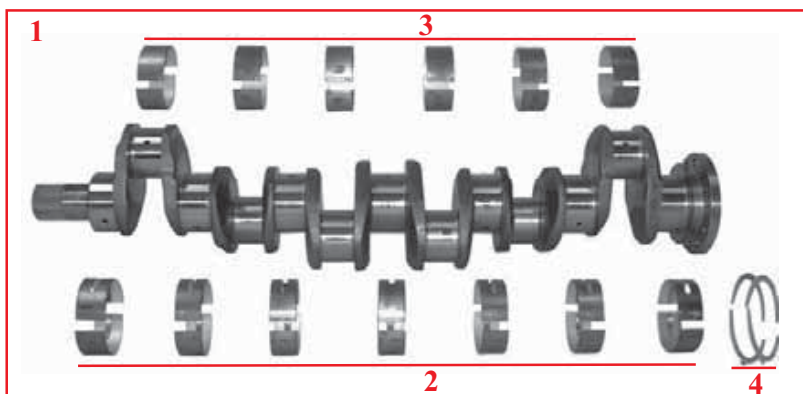

		1	2	3	4
Tracteurs Tractors	Moteur Engine	Jeu vilebrequin Crankshaft kit	Couss. de palier Main bear. set	Couss. de bielle Conrod bear. set	Jeu d'épaisseur lat. Thrust washer kit
6 Moteurs 6 cylindres / 6 cylinder engines					
1100 1014, 1104	A6.354 A6.354.1		30/2-4 (85010, 736930M91)	30/3-4 (85043, 736934M91)	
1200	A6.354.1			30/3-29 (U5ME0003, 3637024M91)	
399, 699, 1014, 1024, 1114, 1250, 2620, 2625, 2640, 2645, 2675, 3080, 3090, 3610	A6.354.4	30/1-29 (D) (ZZ90196, 4224303M91)	30/2-29 (68079, 744921M91)	30/3-4 (85043, 736934M91)	
1105 1130 1135	ATC6.354.1 AT6.354 AT6.354.1		30/2-4 (U5MB0011, 4223140M91)		
1134, 2680, 2685, 2705, 2720, 2725, 3630, 3650	AT6.354.4	30/1-32 (D) (ZZ90165, 4224054M91)	30/2-29 (68079, 744921M91)	30/3-29 (U5ME0003, 3637024M91)	30/6-3 (Std) (U5TW0002)
396, 399, 3085, 3095, 3115, 4260, 4270, 6160, 6170	1006.6 (Blue)			30/3-4 (85043, 736934M91)	30/6-4 (+ 0.19mm) (U5TW0002B)
3120, 3120T, 3125, 3140, 3635, 3645 3655, 3660 (YB31236, YB31247) 6180, 6190, 8110, 8120	1006.6T (Blue)	30/1-72 (ZZ90085, 3637019M91)	30/2-52 (U5MB0007, 3637020M91)		
4260, 4360	1006.60 (Green)				
4270, 4370, 6170, 6180, 6270, 6280, 6290, 8120, 8220	1006.60T (Green)			30/3-29 (U5ME0003, 3637024M91)	
3655, 3660 (YB31263) 8130	1006.6T (Blue)	30/1-32 (ZZ90165, 4224054M91)	30/2-45 (U5MB0010, 3640873M91)		
6260	1006.60				
8210	1006.60T				

Les coussinets de palier et de bielle sont disponibles en cote réparation 0.010"- 0.020"- 0.030". Ajouter respectivement les suffixes A, B, ou C. 0.040"- 0.050"- 0.060" sur demande.
Main and conrod bearing sets are available in 0.010"- 0.020"- 0.030" undersize. Please add the suffix A, B, or C respectively. 0.040"- 0.050"- 0.060" on request.

Les épaisseurs latérales sont disponibles individuellement. Voir page MF-19.
Top and bottom thrust washers are available separately. See page MF-19.

(D) Utiliser avec le pignon de vilebrequin / Use with crankshaft gear 30/12-12 (31171682, 3637519M1)

Les références des pièces sont indicatives.
Nos pièces ne sont pas d'origine

Part numbers are quoted for reference purposes only.
Our parts and accessories are not original.



"THE RELIABLE SERVICE"



VILEBREQUINS & PIÈCES CONNEXES
CRANKSHAFT & RELATED PARTS

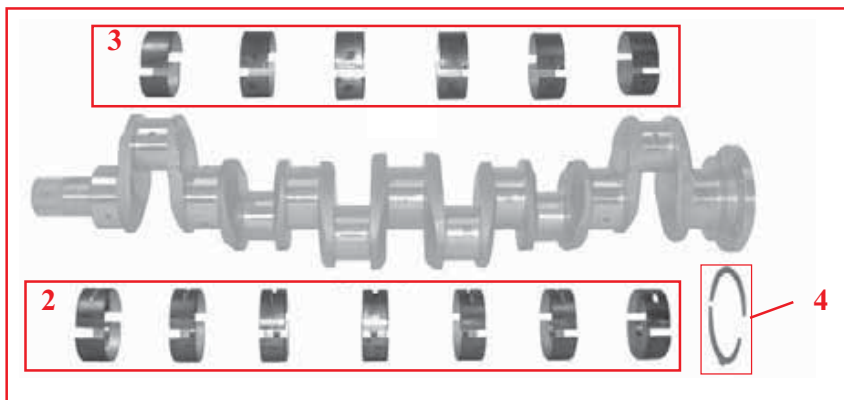

		2	3	4
Tracteurs Tractors	Moteur Engine	Couss. de palier Main bear. set	Couss. de bielle Conrod bear. set	Epaisseur lat. Thrust washer
6 Moteurs 6 cylindres / 6 cylinder engines				
3680, 3690	612DS	30/2-48 (7x 3637631M91, 7x V836119457, 7x V836655514)	30/3-48 (6x V836110552)	1 de chaque 1 of each 30/6-30 (3637636M1, V836119459)
3670, 8140, 8150	620DS			
8240	620DSRAE			
8240Xtra	620DWBAE			
3690, 8160	634DS			
8250, 8260	634DSBAE			
8250Xtra, 8260Xtra	634DWBAE			
8260	634DSBIE			

Les coussinets de palier et de bielle sont disponibles en cote réparation 0.25mm- 0.50mm. Ajouter respectivement les suffixes A, ou B.
 Main and conrod bearing sets are available in 0.25mm - 0.50mm undersize. Please add the suffix A or B respectively.

Les références des pièces sont indicatives.
 Nos pièces ne sont pas d'origine

Part numbers are quoted for reference purposes only.
 Our parts and accessories are not original.



VILEBREQUINS & PIÈCES CONNEXES
CRANKSHAFT & RELATED PARTS

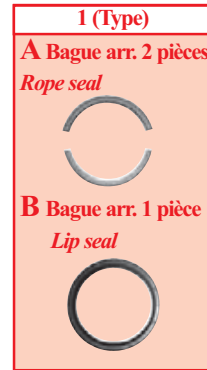
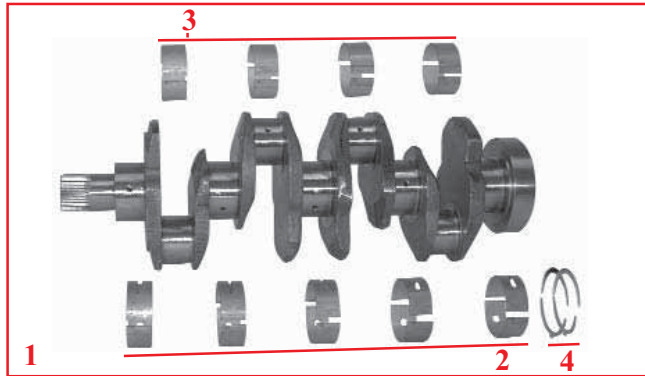

Tracteurs Tractors	Moteur Engine	1 Jeu vilebrequin / Crankshaft kit		2 Couss. de palier Main bear. set	3 Couss. de bielle Conrod bear. set	4 Jeu d'épaisseur lat. Thrust washer kit
4 Moissonneuses-batteuses moteurs 4 cylindres / 4 cylinder engines combines						
186	A4.212	30/1-7 (ZZ90081, 3637401M91)		30/2-3 (81558, 735168M91)	30/3-3 (85042, 736950M91)	30/6-3 (Std) (U5TW0002)
8Plot, 10Plot, 16Plot, 16, 330	A4.236					
20, 430	A4.248					
99, 187, 206, 240, 307	A4.236	Type A 30/1-4 (ZZ90093, 3639541M1)	Type B 30/1-8 (ZZ90082, 3637402M91)	30/2-3 (81558, 735168M91)	30/3-3 (85042, 736950M91)	30/6-4 (+ 0.19mm) (U5TW0002B)
440, 487, 506	A4.248					
20XP	AT4.236				30/3-28 (U5ME0006, 3637791M91)	
788	A4.270					
400, 410, 415	A4.300			30/2-11 (68085, 745584M91)	30/3-11 (85041, 736878M91)	
6 Moissonneuses-batteuses moteurs 6 cylindres / 6 cylinder engines combines						
500, 507, 510, 515, 520, 525	A6.354	30/1-29 (D) (ZZ90196, 4224303M91)		30/2-4 (85010, 736930M91)	30/3-4 (85043, 736934M91)	30/6-3 (Std) (U5TW0002)
620, 625, 740, 750	A6.372					
24, 27, 530, 530S, 535, 800, 805, 810, 815	A6.354.4					
750	A6.372.4			30/2-29 (68079, 744921M91)		
750, 760	AT6.354.1			30/2-4 (U5MB0011, 4223140M91)		30/6-4 (+ 0.19mm) (U5TW0002B)
29, 29XP, 31, 31XP, 560, 565, 660, 665, 750, 760, 820, 825, 830, 835, 840, 845, 850, 855, 860	AT6.354.4	30/1-32 (D) (ZZ90165, 4224054M91)		30/2-29 (68079, 744921M91)	30/3-29 (U5ME0003, 3637024M91)	
4 Chargeurs télescopiques / Telescopic handlers						
24	A4.236	30/1-7 (ZZ90081, 3637401M91)		30/2-3 (81558, 735168M91)	30/3-3 (85042, 736950M91)	30/6-3 (Std) (U5TW0002)
8925, 8926, 8937, 8939	1004.4 (Blue)					
8925, 8926, 8937, 8939	1004.42 (Green)	30/1-42 (ZZ90202, 4223939M91)		30/2-3 (81558, 735168M91)	30/3-28 (U5ME0006, 3637791M91)	30/6-4 (+ 0.19mm) (U5TW0002B)
24T	AT4.236					
8925T, 8926T, 8937T, 8939T	1004.4T (Blue)					
8925T, 8926T, 8937T, 8939T	1004.40T (Green)					

Les coussinets de palier et de bielle sont disponibles en cote réparation 0.010"- 0.020"- 0.030". Ajouter respectivement les suffixes A, B, ou C. 0.040"- 0.050"- 0.060" sur demande.

Main and conrod bearing sets are available in 0.010"- 0.020"- 0.030" undersize. Please add the suffix A, B, or C respectively: 0.040"- 0.050"- 0.060" on request.

Les épaisseurs latérales sont disponibles individuellement. Voir page MF-19. / Top and bottom thrust washers are available separately. See page MF-19.

(D) Utiliser avec le pignon de vilebrequin / Use with crankshaft gear 30/12-12 (31171682, 3637519M1)

Les références des pièces sont indicatives.
Nos pièces ne sont pas d'origine

Part numbers are quoted for reference purposes only.
Our parts and accessories are not original.



VILEBREQUINS & PIÈCES CONNEXES
CRANKSHAFT & RELATED PARTS

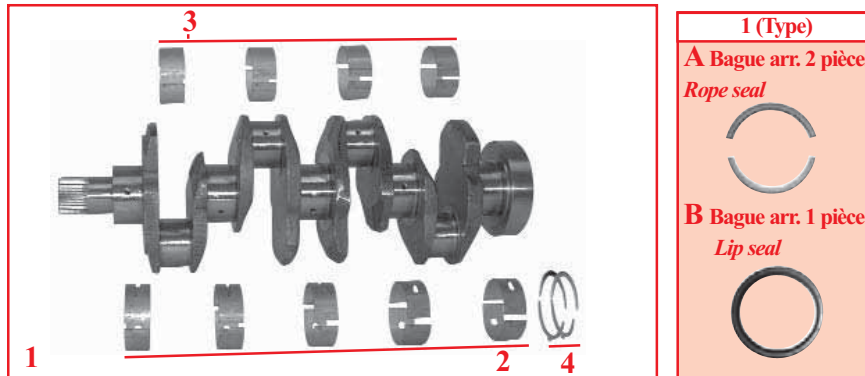

		1		2	3	4
Tracteurs Tractors	Moteur Engine	Jeu vilebrequin Crankshaft kit		Couss. de palier Main bear. set	Couss. de bielle Conrod bear. set	Jeu d'épaisseur lat. Thrust washer kit
Tracteurs industriels moteurs 3 cylindres / 3 cylinder engine industrial tractors						
203, 205 20, 40, 203, 205, 2135, 2203, 2205	A3.152 AG3.152 AD3.152	Type A 30/1-1 (ZZ90148, 4222037M91)	Type B 30/1-5 (ZZ90150, 3641858M91)	30/2-1 (68084, 746156M91)	30/3-1 (85036, 737070M91)	30/6-1 (Std) (U5TW0003)
20B, 20C, 20D, 20E, 20F, 30B, 30E, 30H	AD3.152					
40E (CN31157, CN31158)	AT3.152.4	30/1-26 (ZZ90151, 3641825M91)				30/6-2 (+ 0.19mm) (U5TW0003B)
40E (CN31195, CN31196)	AT3.152.4			30/2-76 (U5MB0008, 3637501M91)	30/3-76 (U5ME0005, 3637509M91)	
Tracteurs industriels moteurs 4 cylindres / 4 cylinder engine industrial tractors						
702	23C			30/2-20 (830897M91)	30/3-20 (830899M91)	
356 30, 40B, 50, 302, 304, 356, 3165, 3303, 3305	A4.203 AD4.203	Type A 30/1-2 (ZZ90121, 3638473M91)	Type B 30/1-34 (ZZ90111, 3637458M91)	30/2-2 (68082, 745405M91)	30/3-2 (85035, 737066M91)	30/6-1 (Std) (U5TW0003) 30/6-2 (+ 0.19mm) (U5TW0003B)
50, 50B, 3303, 3305	A4.212					
30D, 50D, 50E 50H (LD31134, LD31163), 60	A4.236	30/1-8 (ZZ90082, 3637402M91)				
50, 50B, 50B MKII, 50C, 50H (LD31179), 50H-S, 50H-T	A4.236	30/1-7 (ZZ90081, 3637401M91)		30/2-3 (81558, 735168M91)	30/3-3 (85042, 736950M91)	30/6-3 (Std) (U5TW0002)
50EX, 50HX, 50HX-S, 50HX-T, 60H, 60H-S	A4.248					30/6-4 (+ 0.19mm) (U5TW0002B)
60HX, 60HX-T	AT4.236	30/1-8 (ZZ90082, 3637402M91)				
70	A4.318			30/2-11 (68085, 745584M91)	30/3-11 (85041, 736878M91)	
Fermec & Terex - Tracteurs industriels moteurs 4 cylindres / 4 cylinder engine industrial tractors						
750	1004.4 (Blue)	30/1-7 (ZZ90081, 3637401M91)			30/3-3 (85042, 736950M91)	30/6-3 (Std) (U5TW0002)
750, 750B	1004.42 (Green)			30/2-3 (81558, 735168M91)		
760, 860, 860S, 860SE, 865, 960, 965	1004.4T (Blue)	30/1-8 (ZZ90082, 3637402M91)			30/3-28 (U5ME0006, 3637791M91)	30/6-4 (+ 0.19mm) (U5TW0002B)
760, 760B, 860, 860B, 860S, 860SE, 960, 960B, 965	1004.40T (Green)					

Les coussinets de palier et de bielle sont disponibles en cote réparation 0.010"- 0.020"- 0.030". Ajouter respectivement les suffixes A, B, ou C. 0.040"- 0.050"- 0.060" sur demande. *Main and conrod bearing sets are available in 0.010"- 0.020"- 0.030" undersize. Please add the suffix A, B, or C respectively 0.040"- 0.050"- 0.060" on request.*

Les épaisseurs latérales sont disponibles individuellement. Voir page MF-19. *Top and bottom thrust washers are available separately. See page MF-19.*

Les références des pièces sont indicatives.
Nos pièces ne sont pas d'origine

Part numbers are quoted for reference purposes only.
Our parts and accessories are not original.



"THE RELIABLE SERVICE"



**VILEBREQUINS & PIÈCES CONNEXES
CRANKSHAFT & RELATED PARTS**

Composition des jeux d'épaisseurs latérales / Thrust washer kit contents



			Composition / Contents	
Moteur Engine	Dimension Size	Jeu épaisseur lat. Thrust washer kit	Epaisseur supérieure Top thrust washer	Epaisseur inférieure Bottom thrust washer
			Par 2 / Quantity 2	
A3.144, A3.152, AD3.152, AG3.152, AT3.152.4 903.27, 903.27T A4.192, A4.203, AD4.203	Standard Standard	30/6-1 (U5TW0003)	30/4-1 (31137211, 735112M1)	30/5-1 (31137221, 735113M1)
	+0.19mm +0.007"	30/6-2 (U5TW0003B)	30/4-2 (31137212, 735800M1)	30/5-2 (31137222, 735801M1)
A4.212, A4.236, AT4.236, A4.248, A4.318, A4.318.2, A4.41 1004.4, 1004.40, 1004.42, 1004.4T, 1004.40T A6.354, A6.354.1, A6.354.2, A6.354.4 AT6.354, AT6.354.1, ATC6.354.1, AT6.354.3, AT6.354.4 A6.372, A6.372.4 1006.6, 1006.60, 1006.6T, 1006.60T	Standard Standard	30/6-3 (U5TW0002)	30/4-3 (31137551, 747128M1)	30/5-3 (31137561, 747129M1)
	+0.19mm +0.007"	30/6-4 (U5TW0002B)	30/4-4 (31137312, 735742M1)	30/5-4 (31137322, 735743M1)

Les références des pièces sont indicatives.
Nos pièces ne sont pas d'origine

Part numbers are quoted for reference purposes only.
Our parts and accessories are not original.



VILEBREQUINS & PIÈCES CONNEXES
CRANKSHAFT & RELATED PARTS

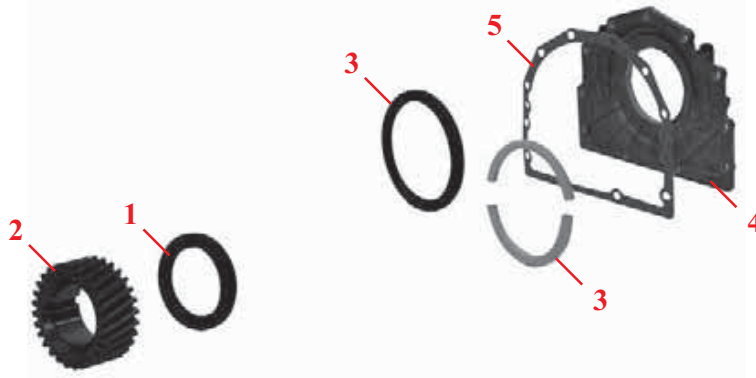

		1	2	3	4	5
Tracteurs Tractors	Moteur Engine	Bague avant Front cover seal	Pignon Crankshaft gear	Bague arrière Rear housing seal	Palier arr. Rear housing	Joint arrière Rear gasket
Moteurs 3 cylindres / 3 cylinder engines						
35, 133, 135	A3.144	(A) 30/11-10 (2415344, 1447689M1)	30/12-10 (31163495, 3641826M1)	Bague arr. 2 pcs <i>Rope seal</i> 30/13-1 (36883119, 4224057M1)	Bague arr. 2 pcs <i>Rope seal</i> 30/14-1 (U5MK0401, 4224172M1)	Bague arr. 2 pcs <i>Rope seal</i> 30/17-1 (36817168, 4222068M1)
35	A3.152			Bague arr. 1 pc <i>Lip seal</i> 30/13-4 (C) (2418F475, 1447691M1)	Bague arr. 1 pc <i>Lip seal</i> 30/17-4 (33826115, 3641894M1)	
133, 134, 135, 140, 145, 148, 150, 152, 154, 233, 253 (Italy), 254	AD3.152					
135	AG3.152			Bague arr. 2 pcs <i>Rope seal</i> 30/13-4 (2418F475, 1447691M1)	Bague arr. 2 pcs <i>Rope seal</i> 30/17-4 (33826115, 3641894M1)	
230, 234, 235, 240, 244CF, 245, 250, 255, 333, 334V, 340, 342, 350, 353, 354, 356CF, 550, 2205, 3210	AD3.152					
164T, 253 (UK), 263T (Italy), 264T, 352, 355, 360, 363, 364, 366CF	AT3.152.4					
2210, 3315, 4215, 4315	903.27					
263 (UK), 2220, 3325, 4220, 4320	903.27T					

- (A) L'ancienne version en cuir est disponible sous la référence 30/11-1 (2414111)
Also available is the early leather seal 30/11-1 (2414111)
- (C) L'ancienne version en silicone rouge est disponible sous la référence 30/13-3 (2415391, 1447049M1)
Also available is the early red silicone seal 30/13-3 (2415391, 1447049M1)

Les références des pièces sont indicatives.
Nos pièces ne sont pas d'origine

*Part numbers are quoted for reference purposes only.
Our parts and accessories are not original.*



VILEBREQUINS & PIÈCES CONNEXES
CRANKSHAFT & RELATED PARTS

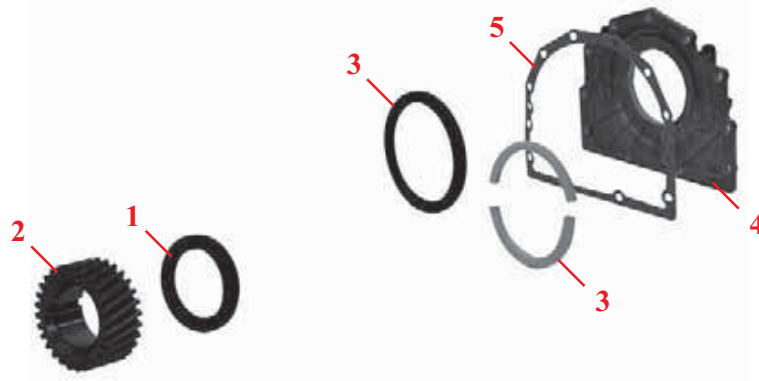

		1	2	3	4	5	
Tracteurs Tractors	Moteur Engine	Bague avant Front cover seal	Pignon Crankshaft gear	Bague arrière Rear housing seal	Palier arr. Rear housing	Joint arrière Rear gasket	
4 Moteurs 4 cylindres / 4 cylinder engines							
TEA20 TED20 TEH20 35, 135	85mm Petrol 85mm VO 85mm LO 87mm Petrol	30/11-15 (825740M1)	30/12-17 (825136M1)	30/13-21 (825208M1)			
TEF20	20C Diesel				30/13-13 (1884098M1)		
FE35, 835	23C Diesel						
25, 122 25, 30, 130, 825	A4.99 A4.107	30/11-12 (0730098, 732043M1)		30/13-5 (36883115, 4224055M1)			
65 65, 865	A4.192 A4.203	51x70x13 30/11-21 (34157, 3639011M1)			Bague arr. 2 pcs <i>Rope seal</i> 30/14-1 (U5MK0401, 4224172M1)	Bague arr. 2 pcs <i>Rope seal</i> 30/17-1 (36817168, 4222068M1)	
		57x76x9.5 30/11-10 (A) (2415344, 1447689M1)		Bague arr. 2 pcs <i>Rope seal</i> 30/13-1 (36883119, 4224057M1)	Bague arr. 1 pc <i>Lip seal</i>	Bague arr. 1 pc <i>Lip seal</i> 30/17-4 (33826115, 3641894M1)	
65, 155, 158, 165, 765	AD4.203	30/11-10 (A) (2415344, 1447689M1)		Bague arr. 1 pc <i>Lip seal</i> 30/13-4 (C) (2418F475, 1447691M1)		Bague arr. 2 pcs <i>Rope seal</i> 30/17-2 (36817174, 4223797M1)	
158 MKIII, 260, 560	AD4.203			30/13-4 (C) (2418F475, 1447691M1)		Bague arr. 1 pc <i>Lip seal</i> 30/17-4 (33826115, 3641894M1)	

(A) L'ancienne version en cuir est disponible sous la référence 30/11-1 (2414111)
Also available is the early leather seal 30/11-1 (2414111)

(C) L'ancienne version en silicone rouge est disponible sous la référence 30/13-3 (2415391, 1447049M1)
Also available is the early red silicone seal 30/13-3 (2415391, 1447049M1)

Les références des pièces sont indicatives.
Nos pièces ne sont pas d'origine

Part numbers are quoted for reference purposes only.
Our parts and accessories are not original.



"THE RELIABLE SERVICE"



VILEBREQUINS & PIÈCES CONNEXES
CRANKSHAFT & RELATED PARTS

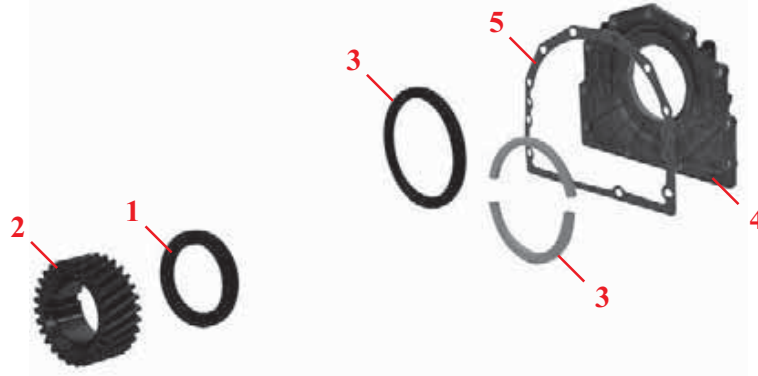

Tracteurs Tractors	Moteur Engine	1 Bague avant Front cover seal	2 Pignon Crankshaft gear	3 Bague arrière Rear housing seal	4 Palier arr. Rear housing	5 Joint arrière Rear gasket
Moteurs 4 cylindres / 4 cylinder engines						
165, 174	A4.212	30/11-11 (B) (2418F436, 1447690M1)	30/12-3 (31171681, 734749M1)	Bague arr. 2 pcs <i>Rope seal</i> 30/13-2 (36883116, 4224056M1)	Bague arr. 2 pcs <i>Rope seal</i> 30/14-3 (U5MK0404, 4224148M91)	Bague arr. 2 pcs <i>Rope seal</i> 30/17-3 (36817166, 3638780M1)
168, 174, 175, 184, 255 (USA)	A4.236			Bague arr. 1 pc <i>Lip seal</i> 30/13-4 (C) (2418F475, 1447691M1)	Bague arr. 1 pc <i>Lip seal</i>	Bague arr. 1 pc <i>Lip seal</i> 30/17-5 (3681T018, 4223587M1)
178, 185, 188, 194	A4.248			30/13-4 (C) (2418F475, 1447691M1)	30/17-5 (3681T018, 4223587M1)	
168MKIII, 265, 273, 274, 275, 275E, 283, 284, 367CF, 373, 374, 375E, 376C, 377, 383, 384, 387, 565, 575, 675, 3050, 3220, 3225	A4.236					
362, 362N, 365, 372N, 375 (⇒ U171963P)	A4.236					
362, 362N, 365, 372N, 375 (U171964P ⇒)						
393TLX, 394TAQ, 396CT, 397T, 698T, 1004T, 1007, 3065, 3065S, 3070, 390T, 398 (⇒ U171963P)	AT4.236					
390T, 398 (U171964P ⇒)	AT4.236					
285, 290, 290E, 293, 294, 390E, 393, 394, 396C, 397, 590, 690, 3055, 3060, 3235 382N, 390 (⇒ U171963P)	A4.248					
382N, 390 (U171964P ⇒)	A4.248					

(B) L'ancienne version en nitrile est disponible sous la référence 30/11-2 (32116, 3639007M1) ainsi que la version silicone rouge 30/11-3 (2415361)
Also available is the early nitrile seal 30/11-2 (32116, 3639007M1) and the red silicon seal 30/11-3 (2415361)

(C) L'ancienne version en silicone rouge est disponible sous la référence 30/13-3 (2415391, 1447049M1)
Also available is the early red silicone seal 30/13-3 (2415391, 1447049M1)

Les références des pièces sont indicatives.
Nos pièces ne sont pas d'origine

Part numbers are quoted for reference purposes only.
Our parts and accessories are not original.



VILEBREQUINS & PIÈCES CONNEXES
CRANKSHAFT & RELATED PARTS

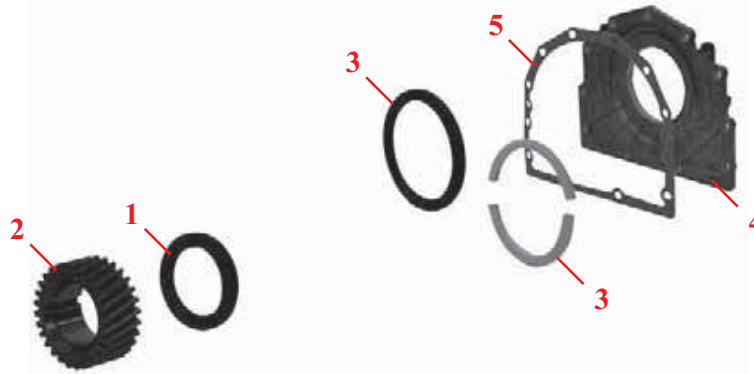

		1	2	3	4	5
Tracteurs Tractors	Moteur Engine	Bague avant Front cover seal	Pignon Crankshaft gear	Bague arrière Rear housing seal	Palier arr. Rear housing	Joint arrière Rear gasket
4 Moteurs 4 cylindres / 4 cylinder engines						
1080, 1085	A4.318	30/11-13 (2415346, 1447024M1)	30/12-16 (31165392, 734637M1)	Bague arr. 2 pcs <i>Rope seal</i> 30/13-2 (36883116, 4224056M1)		Bague arr. 2 pcs <i>Rope seal</i> 30/17-15 (21826321, 4223004M1)
285 (USA), 592, 595	A4.318			Bague arr. 1 pc <i>Lip seal</i> 30/13-4 (C) (2418F475, 1447691M1)		30/17-9 (21826316, 4223021M1)
285 (USA), 298, 592, 595, 698, 1004	A4.318.2					
275E, 290E, 375E, 390E	A4.41	30/11-11 (2418F436, 1447690M1)	30/12-11 (31171683, 3638105M1)	30/13-4 (2418F475, 1447691M1)		30/17-5 (3681T018, 4223587M1)
4225, 4235, 4240, 6110, 6120	A4.41 (Blue)		30/12-3 (31171681, 734749M1)			
374, 3220, 3330	1004.40 (Green)		30/12-18 (3117C062, 4222820M1)			
4225, 4325	1004.40 (Green)		30/12-3 (31171681, 734749M1)			
394, 2230, 3235, 3340	1004.42 (Green)		30/12-18 (3117C062, 4222820M1)			
4235 (USA), 4335	1004.42 (Green)		30/12-3 (31171681, 734749M1)			
3075, 6130, 6140, 6150	1004.4T		30/12-11 (31171683, 3638105M1)			
4245, 4255	1004.4T (Blue)		30/12-3 (31171681, 734749M1)			
3350, 3355	1004.40T		30/12-18 (3117C062, 4222820M1)			
4235, 4245, 4255, 4345, 4355, 6235, 6245, 6255	1004.40T (Green)					
4265, 4365, 6265	1004.40TW (Green)					

(C) L'ancienne version en silicone rouge est disponible sous la référence 30/13-3 (2415391, 1447049M1)
Also available is the early red silicone seal 30/13-3 (2415391, 1447049M1)

Les références des pièces sont indicatives.
Nos pièces ne sont pas d'origine

Part numbers are quoted for reference purposes only.
Our parts and accessories are not original.



"THE RELIABLE SERVICE"



**VILEBREQUINS & PIÈCES CONNEXES
CRANKSHAFT & RELATED PARTS**

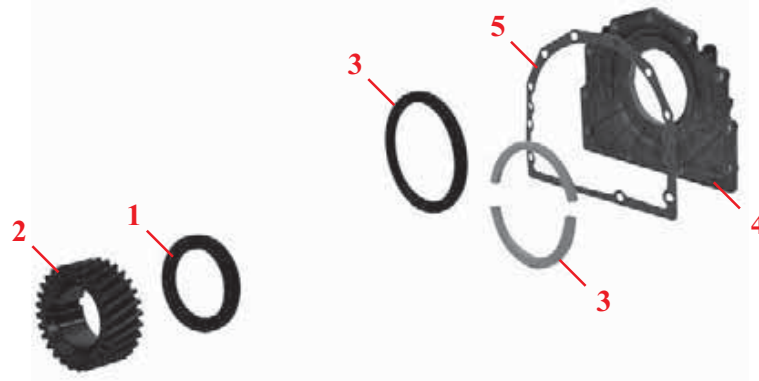

		1	2	3	4	5	
Tracteurs Tractors	Moteur Engine	Bague avant Front cover seal	Pignon Crankshaft gear	Bague arrière Rear housing seal	Palier arr. Rear housing	Joint arrière Rear gasket	
Moteurs 6 cylindres / 6 cylinder engines							
1100 1014, 1104, 1200	A6.354 A6.354.1	30/11-11 (B) (2418F436, 1447690M1)	30/12-4 (31171211, 733757M1)	Bague arr. 2 pcs Rope seal 30/13-2 (36883116, 4224056M1)	Bague arr. 2 pcs Rope seal 30/14-3 (U5MK0404, 4224148M91)	Bague arr. 2 pcs Rope seal 30/17-3 (36817166, 3638780M1)	
				Bague arr. 1 pc Lip seal 30/13-4 (C) (2418F475, 1447691M1)	Bague arr. 1 pc Lip seal	Bague arr. 1 pc Lip seal	Bague arr. 1 pc Lip seal 30/17-5 (3681T018, 4223587M1)
399, 699, 1014, 1114, 1250, 2620, 2625, 2640, 2645, 2675 Vilebrequin / Crankshaft 68076	A6.354.4				30/13-4 (2418F475, 1447691M1)		30/17-5 (3681T018, 4223587M1)
399, 699, 1014, 1024, 1114, 1250, 2620, 2625, 2640, 2645, 2675, 3080, 3090, 3610 Vilebrequin / Crankshaft U5BG0037, ZZ90113, ZZ90196	A6.354.4			30/12-12 (31171682, 3637519M1)			
1105 1130 1135	ATC6.354.1 AT6.354 AT6.354.1			30/12-4 (31171211, 733757M1)	Bague arr. 2 pcs Rope seal 30/13-2 (36883116, 4224056M1)	Bague arr. 2 pcs Rope seal 30/14-3 (U5MK0404, 4224148M91)	Bague arr. 2 pcs Rope seal 30/17-3 (36817166, 3638780M1)
					Bague arr. 1 pc Lip seal 30/13-4 (C) (2418F475, 1447691M1)	Bague arr. 1 pc Lip seal	Bague arr. 1 pc Lip seal 30/17-5 (3681T018, 4223587M1)
1134, 2680, 2685, 2705, 2720, 2725 Vilebrequin / Crankshaft 68055, 68077	AT6.354.4			30/13-4 (2418F475, 1447691M1)		30/17-5 (3681T018, 4223587M1)	
1134, 2680, 2685, 2705, 2720, 2725, 3630, 3650 Vilebrequin / Crankshaft U5BG0034, U5BG0035, ZZ90086, ZZ90105, ZZ90165	AT6.354.4		30/12-12 (31171682, 3637519M1)				

- (B) L'ancienne version en nitrile est disponible sous la référence 30/11-2 (32116, 3639007M1) ainsi que la version silicone rouge 30/11-3 (2415361)
Also available is the early nitrile seal 30/11-2 (32116, 3639007M1) and the red silicon seal 30/11-3 (2415361)
- (C) L'ancienne version en silicone rouge est disponible sous la référence 30/13-3 (2415391, 1447049M1)
Also available is the early red silicone seal 30/13-3 (2415391, 1447049M1)

Les références des pièces sont indicatives.
Nos pièces ne sont pas d'origine

Part numbers are quoted for reference purposes only.
Our parts and accessories are not original.



VILEBREQUINS & PIÈCES CONNEXES
CRANKSHAFT & RELATED PARTS

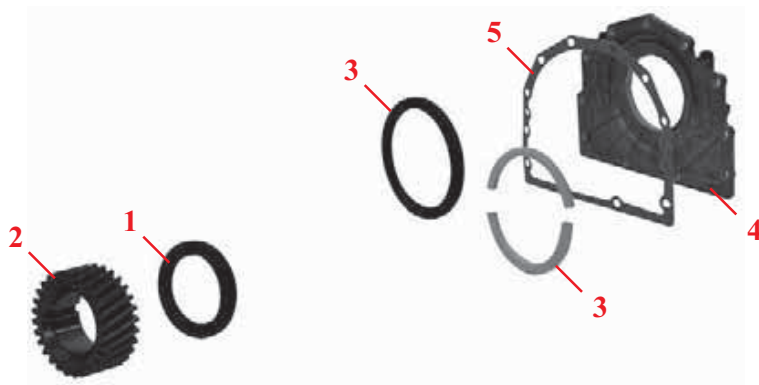

		1	2	3	4	5					
Tracteurs Tractors	Moteur Engine	Bague avant Front cover seal	Pignon Crankshaft gear	Bague arrière Rear housing seal	Palier arr. Rear housing	Joint arrière Rear gasket					
6 Moteurs 6 cylindres / 6 cylinder engines											
396, 399, 3085, 3095, 3115, 4260, 4270, 6160, 6170	1006.6 (Blue)	30/11-11 (2418F436, 1447690M1)	30/12-15 (3117C061, 748201M1)	30/13-4 (2418F475, 1447691M1)		30/17-5 (3681T018, 4223587M1)					
4260, 4360, 6260	1006.60 (Green)										
3120, 3120T, 3125, 3140, 3635, 3645, 3655, 3660, 6180, 6190, 8110, 8120, 8130	1006.6T (Blue)										
4270, 4370, 6170, 6180, 6270, 6280, 6290, 8120, 8210, 8220	1006.60T (Green)										
3680, 3690	612DS	30/11-32 (V614105880, 3637617M1)		30/13-35 (V614400002, V614500002, 3637618M1)							
3670, 8140, 8150	620DS										
8240	620DSRAE										
8240Xtra	620DWBAE										
3690, 8160	634DS										
8250, 8260	634DSBAE										
8260	634DSBIE										
8250Xtra, 8260Xtra	634DWBAE										
8170, 8180, 8270, 8280	645DSBIE						30/11-33 (V836840883)				

Les références des pièces sont indicatives.
Nos pièces ne sont pas d'origine

Part numbers are quoted for reference purposes only.
Our parts and accessories are not original.



"THE RELIABLE SERVICE"



VILEBREQUINS & PIÈCES CONNEXES
CRANKSHAFT & RELATED PARTS

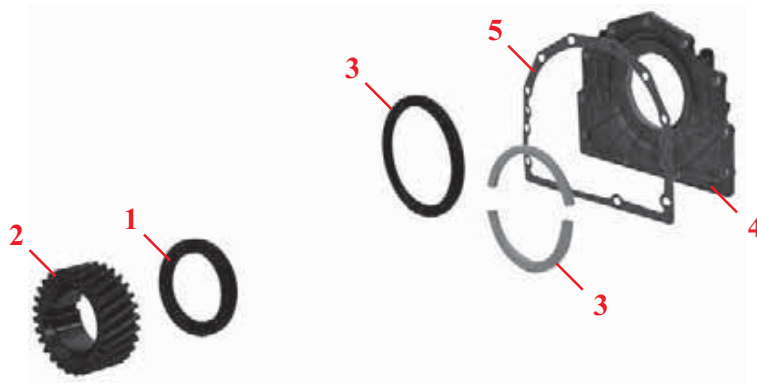

Tracteurs Tractors	Moteur Engine	1 Bague avant Front cover seal	2 Pignon Crankshaft gear	3 Bague arrière Rear housing seal	4 Palier arr. Rear housing	5 Joint arrière Rear gasket
 Moissonneuses-batteuses moteurs 4 cylindres / 4 cylinder engines combines						
186	A4.212	30/11-11 (B) (2418F436, 1447690M1)	30/12-3 (31171681, 734749M1)	Bague arr. 2 pcs <i>Rope seal</i> 30/13-2 (36883116, 4224056M1)	Bague arr. 2 pcs <i>Rope seal</i> 30/14-3 (U5MK0404, 4224148M91)	Bague arr. 2 pcs <i>Rope seal</i> 30/17-3 (36817166, 3638780M1)
99, 187, 206, 307	A4.236			Bague arr. 1 pc <i>Lip seal</i> 30/13-4 (C) (2418F475, 1447691M1)	Bague arr. 1 pc <i>Lip seal</i>	Bague arr. 1 pc <i>Lip seal</i> 30/17-5 (3681T018, 4223587M1)
487, 506	A4.248			30/13-4 (2418F475, 1447691M1)		30/17-5 (3681T018, 4223587M1)
8 Plot, 10 Plot, 16 Plot, 16, 240, 330	A4.236					
20, 430, 440	A4.248					
20XP	AT4.236					
788	A4.270	30/11-34 (34186, 3639012M1)		30/13-2 (36883116, 4224056M1)		
400, 410, 415	A4.300	30/11-13 (2415346, 1447024M1)	30/12-16 (31165392, 734637M1)			30/17-15 (21826321, 4223004M1)

(B) L'ancienne version en nitrile est disponible sous la référence 30/11-2 (32116, 3639007M1) ainsi que la version silicone rouge 30/11-3 (2415361)
Also available is the early nitrile seal 30/11-2 (32116, 3639007M1) and the red silicon seal 30/11-3 (2415361)

(C) L'ancienne version en silicone rouge est disponible sous la référence 30/13-3 (2415391, 1447049M1)
Also available is the early red silicone seal 30/13-3 (2415391, 1447049M1)

Les références des pièces sont indicatives.
Nos pièces ne sont pas d'origine

*Part numbers are quoted for reference purposes only.
Our parts and accessories are not original.*



VILEBREQUINS & PIÈCES CONNEXES
CRANKSHAFT & RELATED PARTS

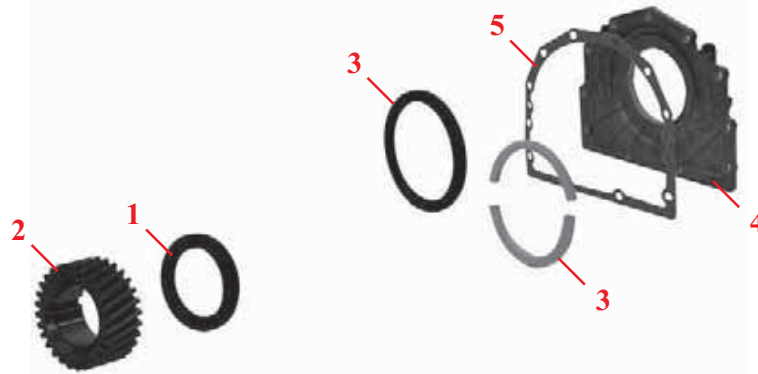

		1	2	3	4	5				
Tracteurs Tractors	Moteur Engine	Bague avant Front cover seal	Pignon Crankshaft gear	Bague arrière Rear housing seal	Palier arr. Rear housing	Joint arrière Rear gasket				
6 Moissonneuses-batteuses moteurs 6 cylindres / 6 cylinder engines combines										
500, 507, 510, 515, 520, 525	A6.354	30/11-11 (B) (2418F436, 1447690M1)	30/12-4 (31171211, 733757M1)	Bague arr. 2 pcs <i>Rope seal</i> 30/13-2 (36883116, 4224056M1)	Bague arr. 2 pcs <i>Rope seal</i> 30/14-3 (U5MK0404, 4224148M91)	Bague arr. 2 pcs <i>Rope seal</i> 30/17-3 (36817166, 3638780M1)				
620, 625, 740, 750	A6.372			Bague arr. 1 pc <i>Lip seal</i> 30/13-4 (C) (2418F475, 1447691M1)	Bague arr. 1 pc <i>Lip seal</i>	Bague arr. 1 pc <i>Lip seal</i> 30/17-5 (3681T018, 4223587M1)				
24, 27, 530, 530S, 535, 800, 805, 810, 815 <i>Vilebrequin / Crankshaft 68076</i>	A6.354.4		30/12-12 (31171682, 3637519M1)	30/13-4 (2418F475, 1447691M1)			30/17-5 (3681T018, 4223587M1)			
24, 27, 530, 530S, 535, 800, 805, 810, 815 <i>Vilebrequin / Crankshaft U5BG0037, ZZ90113, ZZ90196</i>	A6.354.4									
750	A6.372.4		30/12-4 (31171211, 733757M1)	30/13-4 (2418F475, 1447691M1)	Bague arr. 2 pcs <i>Rope seal</i> 30/13-2 (36883116, 4224056M1)	Bague arr. 2 pcs <i>Rope seal</i> 30/14-3 (U5MK0404, 4224148M91)	Bague arr. 2 pcs <i>Rope seal</i> 30/17-3 (36817166, 3638780M1)			
750, 760	AT6.354.1							Bague arr. 1 pc <i>Lip seal</i> 30/13-4 (C) (2418F475, 1447691M1)	Bague arr. 1 pc <i>Lip seal</i>	Bague arr. 1 pc <i>Lip seal</i> 30/17-5 (3681T018, 4223587M1)
29, 29XP, 31, 31XP, 560, 565, 660, 665, 750, 760, 820, 825, 830, 835, 840, 845, 850, 855, 860 <i>Vilebrequin / Crankshaft 68055, 68077</i>	AT6.354.4							30/12-12 (31171682, 3637519M1)	30/13-4 (2418F475, 1447691M1)	
29, 29XP, 31, 31XP, 560, 565, 660, 665, 750, 760, 820, 825, 830, 835, 840, 845, 850, 855, 860 <i>Vilebrequin / Crankshaft U5BG0034, U5BG0035, ZZ90086, ZZ90105, ZZ90165</i>	AT6.354.4									

- (B) L'ancienne version en nitrile est disponible sous la référence 30/11-2 (32116, 3639007M1) ainsi que la version silicone rouge 30/11-3 (2415361)
Also available is the early nitrile seal 30/11-2 (32116, 3639007M1) and the red silicon seal 30/11-3 (2415361)
- (C) L'ancienne version en silicone rouge est disponible sous la référence 30/13-3 (2415391, 1447049M1)
Also available is the early red silicone seal 30/13-3 (2415391, 1447049M1)

Les références des pièces sont indicatives.
Nos pièces ne sont pas d'origine

*Part numbers are quoted for reference purposes only.
Our parts and accessories are not original.*





"THE RELIABLE SERVICE"

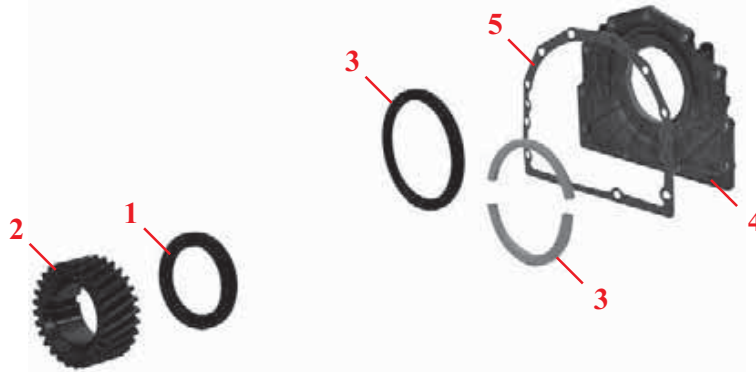

VILEBREQUINS & PIÈCES CONNEXES
CRANKSHAFT & RELATED PARTS



		1	2	3	4	5
		Bague avant Front cover seal	Pignon Crankshaft gear	Bague arrière Rear housing seal	Palier arr. Rear housing	Joint arrière Rear gasket
Chargeurs télescopiques / Telescopic handlers						
	Tracteurs Tractors	Moteur Engine				
24	A4.236	30/11-11 (2418F436, 1447690M1)	30/12-3 (31171681, 734749M1)	30/13-4 (2418F475, 1447691M1)		30/17-5 (3681T018, 4223587M1)
24T	AT4.236					
8925, 8926, 8937, 8939	1004.4 (Blue)					
8925, 8926, 8937, 8939	1004.42 (Green)					
8925T, 8926T, 8937T, 8939T	1004.4T (Blue)					
8925T, 8926T, 8937T, 8939T	1004.40T (Green)					
Tracteurs industriels moteurs 3 cylindres / 3 cylinder engine industrial tractors						
						
203, 205	A3.152	(A) 30/11-10 (2415344, 1447689M1)	30/12-10 (31163495, 3641826M1)	Bague arr. 2 pcs <i>Rope seal</i> 30/13-1 (36883119, 4224057M1)	Bague arr. 2 pcs <i>Rope seal</i> 30/14-1 (U5MK0401, 4224172M1)	Bague arr. 2 pcs <i>Rope seal</i> 30/17-1 (36817168, 4222068M1)
20, 40	AG3.152					
20, 40, 203, 205, 2135, 2203, 2205	AD3.152			Bague arr. 1 pc <i>Lip seal</i> 30/13-4 (C) (2418F475, 1447691M1)	Bague arr. 1 pc <i>Lip seal</i>	Bague arr. 1 pc <i>Lip seal</i> 30/17-4 (33826115, 3641894M1)
20B, 20C, 20D, 20E, 20F, 30B, 30E, 30H	AD3.152			30/13-4 (2418F475, 1447691M1)		30/17-4 (33826115, 3641894M1)
40E	AT3.152.4					

- (A) L'ancienne version en cuir est disponible sous la référence 30/11-1 (2414111)
Also available is the early leather seal 30/11-1 (2414111)
- (C) L'ancienne version en silicone rouge est disponible sous la référence 30/13-3 (2415391, 1447049M1)
Also available is the early red silicone seal 30/13-3 (2415391, 1447049M1)

Les références des pièces sont indicatives.
Nos pièces ne sont pas d'origine

Part numbers are quoted for reference purposes only.
Our parts and accessories are not original.



VILEBREQUINS & PIÈCES CONNEXES
CRANKSHAFT & RELATED PARTS

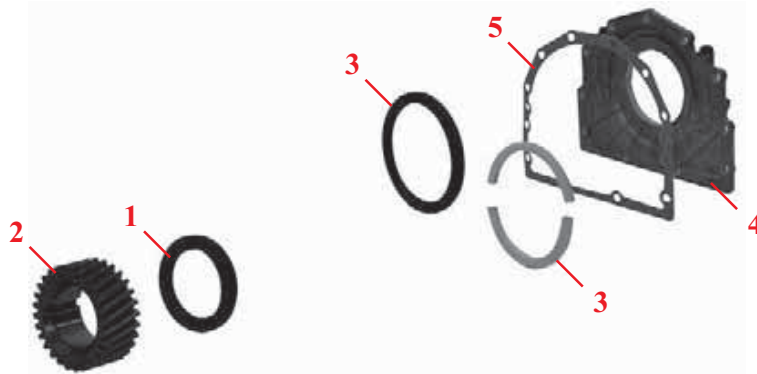

Tracteurs Tractors	Moteur Engine	1 Bague avant Front cover seal	2 Pignon Crankshaft gear	3 Bague arrière Rear housing seal	4 Palier arr. Rear housing	5 Joint arrière Rear gasket
Tracteurs industriels moteurs 4 cylindres / 4 cylinder engine industrial tractors						
702	23C Diesel	30/11-15 (825740M1)		30/13-13 (1884098M1)		
356	A4.203	30/11-10 (A) (2415344, 1447689M1)		Bague arr. 2 pcs <i>Rope seal</i> 30/13-1 (36883119, 4224057M1)	Bague arr. 2 pcs <i>Rope seal</i> 30/14-1 (U5MK0401, 4224172M1)	Bague arr. 2 pcs <i>Rope seal</i> 30/17-1 (36817168, 4222068M1)
30, 40B, 50, 302, 304, 356, 3165, 3303, 3305	AD4.203		Bague arr. 1 pc <i>Lip seal</i> 30/13-4 (C) (2418F475, 1447691M1)	Bague arr. 1 pc <i>Lip seal</i> 30/17-4 (33826115, 3641894M1)		
50, 50B, 3303, 3305	A4.212	30/11-11 (B) (2418F436, 1447690M1)	30/12-3 (31171681, 734749M1)	Bague arr. 2 pcs <i>Rope seal</i> 30/13-2 (36883116, 4224056M1)	Bague arr. 2 pcs <i>Rope seal</i> 30/14-3 (U5MK0404, 4224148M91)	Bague arr. 2 pcs <i>Rope seal</i> 30/17-3 (36817166, 3638780M1)
				Bague arr. 1 pc <i>Lip seal</i> 30/13-4 (C) (2418F475, 1447691M1)	Bague arr. 1 pc <i>Lip seal</i>	Bague arr. 1 pc <i>Lip seal</i> 30/17-5 (3681T018, 4223587M1)

- (A) L'ancienne version en cuir est disponible sous la référence 30/11-1 (2414111)
Also available is the early leather seal 30/11-1 (2414111)
- (B) L'ancienne version en nitrile est disponible sous la référence 30/11-2 (32116, 3639007M1)
ainsi que la version silicone rouge 30/11-3 (2415361)
Also available is the early nitrile seal 30/11-2 (32116, 3639007M1) and the red silicon seal 30/11-3 (2415361)
- (C) L'ancienne version en silicone rouge est disponible sous la référence 30/13-3 (2415391, 1447049M1)
Also available is the early red silicone seal 30/13-3 (2415391, 1447049M1)

Les références des pièces sont indicatives.
Nos pièces ne sont pas d'origine

*Part numbers are quoted for reference purposes only.
Our parts and accessories are not original.*



"THE RELIABLE SERVICE"



VILEBREQUINS & PIÈCES CONNEXES
CRANKSHAFT & RELATED PARTS

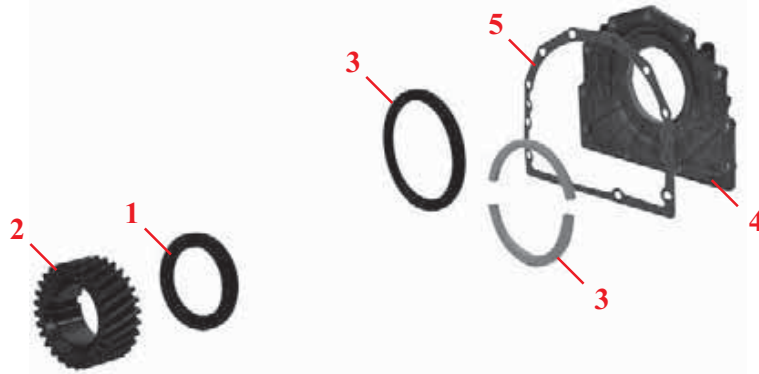

		1	2	3	4	5
Tracteurs Tractors	Moteur Engine	Bague avant Front cover seal	Pignon Crankshaft gear	Bague arrière Rear housing seal	Palier arr. Rear housing	Joint arrière Rear gasket
Tracteurs industriels moteurs 4 cylindres / 4 cylinder engine industrial tractors						
30D, 50, 50B, 50B MKII, 50C, 50D, 50E, 50H, 50H-S, 50H-T, 60	A4.236	30/11-11 (2418F436, 1447690M1)	30/12-3 (31171681, 734749M1)	30/13-4 (2418F475, 1447691M1)		30/17-5 (3681T018, 4223587M1)
50EX, 50HX, 50HX-S, 50HX-T, 60H, 60H-S	A4.248					
60HX, 60HX-T	AT4.236					
70	A4.318	30/11-13 (2415346, 1447024M1)				30/17-9 (21826316, 4223021M1)
Fermec & Terex - Tracteurs industriels moteurs 4 cylindres / 4 cylinder engine industrial tractors						
750	1004.4 (Blue)	30/11-11 (2418F436, 1447690M1)	30/12-3 (31171681, 734749M1)	30/13-4 (2418F475, 1447691M1)		30/17-5 (3681T018, 4223587M1)
750, 750B	1004.42 (Green)					
760, 860, 860S, 860SE, 865, 960, 965	1004.4T (Blue)					
760, 760B	1004.40T (Green)					
860, 860B, 860S, 860SE, 960, 960B, 965	1004.40T (Green)					
			30/12-15 (3117C061, 748201M1)			

Les références des pièces sont indicatives.
Nos pièces ne sont pas d'origine

Part numbers are quoted for reference purposes only.
Our parts and accessories are not original.



MANCHON D'USURE WEAR SLEEVE

Séries "200", "4200", "6200" series
Moteurs A4.236, A4.41, 1004, 1006 Engines

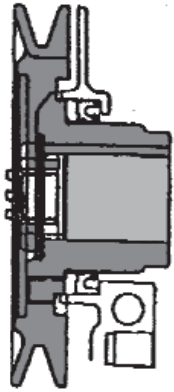

30/18-1
(21820104,
4222564M91)

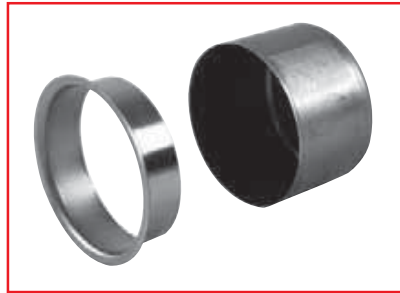

30/18-1 est un manchon d'usure pour reconditionner les poulies de vilebrequin sur les moteurs équipés des dernières versions de boîtier de distribution à partir des numéros de série :

4.236 et 4.41 : U786357C ⇨

1004 : U802612C ⇨

1006 : U714848E ⇨

Une nouvelle bague avant 30/11-11 (2418F436, 1447690M1) doit être montée avec le manchon d'usure 30/18-1

30/18-1 is a wear sleeve service kit to recondition worn crankshaft pulleys on engines fitted with the latest timing case from the following serial numbers.

4.236 et 4.41 : U786357C ⇨

1004 : U802612C ⇨

1006 : U714848E ⇨

A new front seal 30/11-11 (2418F436, 1447690M1) must be fitted with the 30/18-1 wear sleeve

PASTILLES ANTIGEL CORE PLUGS



Pastilles en acier doux Mild steel core plugs

Réf. Ref.	Ø mm	Ø inch	OEM
30/2410-1	Jeux contenant 8x chaque pastilles en acier doux sauf 30/21-50 Kit contains 8 of each mild steel core plug except 30/21-50		
30/21-17	17.6	0.69	0650566, 731356M1
30/21-19	19.4	0.75	
30/21-22	22.6	0.88	0650664, 731999M1
30/21-25	25.8	1.00	0650576, 3639193M1
30/21-32	32.2	1.25	0650563, 735865M1
30/21-35	35.4	1.38	0650618, 376190X1
30/21-38	38.5	1.50	32416118, 4222012M1
30/21-50	50.2	1.97	32416119, 4222043M1

Pastilles en acier inoxydable Stainless steel core plugs

Réf. Ref.	Ø mm	Ø inch	OEM
30/22-32	32.2	1.25	0650710, 731354M1
30/22-35	35.4	1.38	32418117, 735944M1
30/22-38	38.5	1.50	32418122, 746259M1

Les références des pièces sont indicatives.
Nos pièces ne sont pas d'origine

Part numbers are quoted for reference purposes only.
Our parts and accessories are not original.



BIELLES & PIÈCES CONNEXES
CONNECTING RODS & RELATED PARTS

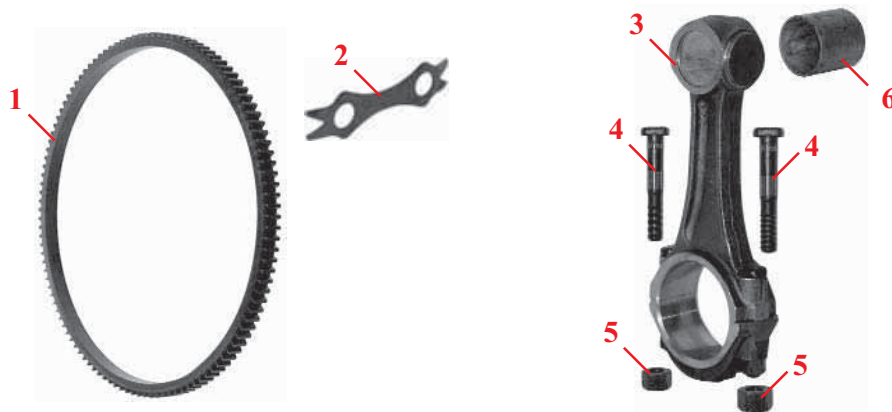

Tracteurs Tractors	Moteur Engine	1 Couronne de démarrage Ring gear	2 Frein de vis Tab washer	3 Bielle Conrod	4 Boulon de bielle Conrod bolt	5 Ecrou de bielle Conrod nut	6 Bague de bielle Small end bush
3 Moteurs 3 cylindres / 3 cylinder engines							
35, 133, 135	A3.144	30/15-1 (0410236, 731008M1, 3819719M1)	30/16-1 (0921062, 731192M1)	30/25-1 (ZZ90011, 3637439M91)			
35	A3.152						
135	AG3.152						
133, 134, 135, 140, 145, 148, 150, 152, 154, 233, 234, 235, 240, 244CF, 245, 250, 253 (Italy), 254, 255, 333, 334V, 550	AD3.152						
353, 354 (⇒ 12/94)							
230, 340, 342, 350	AD3.152						
353, 354 (1/95 ⇒) 356CF, 2205, 3210	AD3.152	30/15-13 (3552228M1)			30/26-1 (0095250, 375756X1)	30/27-1 (33221327, 1476245X1)	30/28-1 (31134151, 740407M1)
164T, 263T (Italy), 264T	AT3.152.4	30/15-1 (0410236, 731008M1, 3819719M1)	30/16-1 (0921062, 731192M1)	30/25-2 (ZZ90010, 3637392M91)			
253 (UK), 352, 355, 360 363, 364 (⇒ 12/94)	AT3.152.4						
363, 364 (1/95 ⇒) 366CF	AT3.152.4	30/15-13 (3552228M1, 0.011.9771.0)					
2210, 3315	903.27						
2220, 3325	903.27T						
4215, 4315	903.27	30/15-1 (0410236, 731008M1, 3819719M1)					
263 (UK), 4220, 4320	903.27T						

Les références des pièces sont indicatives.
Nos pièces ne sont pas d'origine

Part numbers are quoted for reference purposes only.
Our parts and accessories are not original.



BIELLES & PIÈCES CONNEXES
CONNECTING RODS & RELATED PARTS

Pour les volants
moteurs
voir page 232
*For the flywheel
assy.
see page 232*

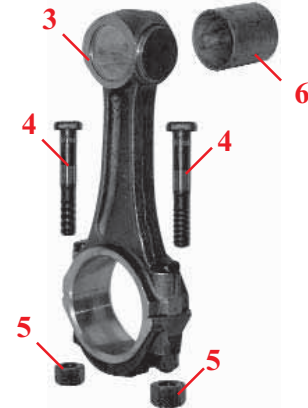

Tracteurs Tractors	Moteur Engine	1 Couroanne de démarrage Ring gear	2 Frein de vis Tab washer	3 Bielle Conrod	4 Boulon de bielle Conrod bolt	5 Ecrou de bielle Conrod nut	6 Bague de bielle Small end bush		
Moteurs 4 cylindres / 4 cylinder engines									
TEF20	20C Diesel	30/15-15 (826049M1)							
FE35, 835	23C Diesel						30/28-33 (1884944M1)		
25, 122	20C Diesel						30/28-3 (31134146, 738339M1)		
25, 30, 130, 825	23C Diesel								
65	A4.192	30/15-1 (0410236, 731008M1, 3819719M1)	30/16-1 (0921062, 731192M1)	30/25-1 (ZZ90011, 3637439M91)	30/26-1 (0095250, 375756X1)	30/27-1 (33221327, 1476245X1)	30/28-1 (31134151, 740407M1)		
65, 865	A4.203			30/25-2 (ZZ90010, 3637392M91)					
65, 155, 158, 158MKIII, 165, 260, 560, 765	AD4.203								
165, 174	A4.212								
168, 174, 175, 184, 255 (USA), 265, 273, 274, 275, 283, 284, 565, 575	A4.236								
168MKIII, 275E, 362, 362N, 365, 372N, 375, 375E, 675, 3050	A4.236					30/25-3 (ZZ90009, 3637034M91)			
373, 374, 383, 384 (⇒ 12/94)									
373, 374, 383, 384 (1/95 ⇒)									
367CF, 376C, 377, 387, 3220, 3225	A4.236			30/15-13 (3552228M1)					
390T, 398, 698T, 1004T, 3065, 3065S, 3070	AT4.236			30/15-1 (0410236, 731008M1, 3819719M1)		30/25-11 (ZZ90013, 3637028M91)		30/26-2 (32762145, 4222485M1)	30/27-2 (33221328, 3637030M1)
393TLX, 394TAQ, 396CT, 397T, 1007	AT4.236	30/15-13 (3552228M1)	30/16-1 (0921062, 731192M1)						
178, 185, 188, 194, 285, 290, 293, 294, 590	A4.248	30/15-1 (0410236, 731008M1, 3819719M1)							
290E, 382N, 390, 390E, 690, 3055, 3060	A4.248			30/25-3 (ZZ90009, 3637034M91)			30/28-2 (31134123, 733767M1)		
393, 394 (⇒ 12/94)									
393, 394 (1/95 ⇒)									
396C, 397, 3235	A4.248	30/15-13 (3552228M1)							

Les références des pièces sont indicatives.
Nos pièces ne sont pas d'origine

Part numbers are quoted for reference purposes only.
Our parts and accessories are not original.



BIELLES & PIÈCES CONNEXES
CONNECTING RODS & RELATED PARTS

Pour les volants
moteurs
voir page 232
*For the flywheel
assy.
see page 232*

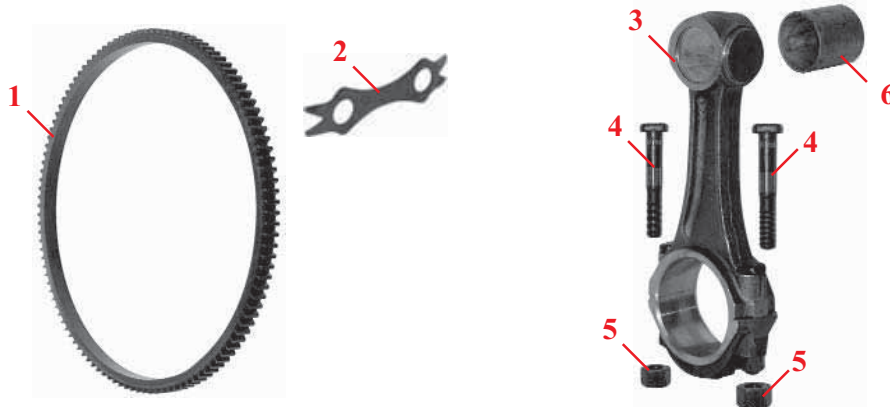

Tracteurs Tractors	Moteur Engine	1 Couronne de démarrage Ring gear	2 Frein de vis Tab washer	3 Bielle Conrod	4 Boulon de bielle Conrod bolt	5 Ecrou de bielle Conrod nut	6 Bague de bielle Small end bush	
4 Moteurs 4 cylindres / 4 cylinder engines								
285 (USA), 592, 595, 1080, 1085	A4.318	30/15-5 (0410264, 731988M1)	30/16-1 (0921062, 731192M1)				30/28-8 (0050128, 731463M1)	
285 (USA), 298, 592, 595, 698, 1004	A4.318.2							
275E, 290E, 375E, 390E, 4225, 4235, 4240, 6110, 6120	A4.41 (Blue)	30/15-1 (0410236, 731008M1, 3819719M1)		30/25-3 (ZZ90009, 3637034M91)			30/28-2 (31134123, 733767M1)	
3075, 4245, 4255, 6130, 6140, 6150	1004.4T (Blue)							30/25-11 (ZZ90013, 3637028M91)
374, 3220, 3330	1004.40 (Green)	30/15-13 (3552228M1, 0.011.9771.0)			30/26-2 (32762145, 4222485M1)	30/27-2 (33221328, 3637030M1)		
3350, 3355	1004.40T (Green)							
394, 2230, 3235, 3340	1004.42 (Green)							
4235 (USA), 4335	1004.42 (Green)							
4225, 4325	1004.40 (Green)	30/15-1 (0410236, 731008M1, 3819719M1)					30/28-41 (3112E011, 4222131M1)	
4235, 4245, 4255, 4345, 4355, 6235, 6245, 6255	1004.40T (Green)							30/26-13 (32186142, 4222132M1)
4265, 4365, 6265	1004.40TW (Green)							

Les références des pièces sont indicatives.
Nos pièces ne sont pas d'origine

Part numbers are quoted for reference purposes only.
Our parts and accessories are not original.



BIELLES & PIÈCES CONNEXES
CONNECTING RODS & RELATED PARTS

Pour les volants
moteurs
voir page 232
*For the flywheel
assy.
see page 232*

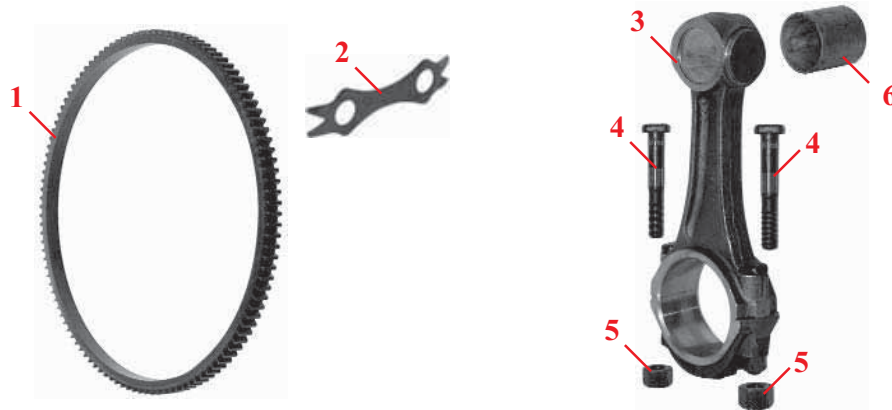

Tracteurs Tractors	Moteur Engine	1 Couronne de démarrage Ring gear	2 Frein de vis Tab washer	3 Bielle Conrod	4 Boulon de bielle Conrod bolt	5 Ecrou de bielle Conrod nut	6 Bague de bielle Small end bush			
6 Moteurs 6 cylindres / 6 cylinder engines										
1100	A6.354	30/15-5 (0410264, 731988M1)	30/16-1 (0921062, 731192M1)	30/25-3 (ZZ90009, 3637034M91)	30/26-2 (32762145, 4222485M1)	30/27-2 (33221328, 3637030M1)	30/28-2 (31134123, 733767M1)			
1014, 1104	A6.354.1									
1200	A6.354.1									
399, 699	A6.354.4	30/15-16 (31161148, 747694M1, 3819720M1)								
1014, 1024, 1114	A6.354.4	30/15-5 (0410264, 731988M1)								
1250	A6.354.4	30/15-14 (31162121, 738588M1)								
2620, 2625, 2640, 2645, 3080, 3090, 3610	A6.354.4	30/15-7 (1619032M1, 31162126, 741138M1)	30/16-1 (0921062, 731192M1)							
2675	A6.354.4									
1105 1130 1135	ATC6.354.1 AT6.354 AT6.354.1	30/15-5 (0410264, 731988M1)	30/16-1 (0921062, 731192M1)							
1134	AT6.354.4									
2680, 2685, 2720, 2725, 3630, 3650	AT6.354.4	30/15-7 (1619032M1, 31162126, 741138M1)	30/16-1 (0921062, 731192M1)	30/25-11 (ZZ90013, 3637028M91)			30/28-16 (31134131, 744971M1)			
2705	AT6.354.4									

Les références des pièces sont indicatives.
Nos pièces ne sont pas d'origine

Part numbers are quoted for reference purposes only.
Our parts and accessories are not original.



"THE RELIABLE SERVICE"



BIELLES & PIÈCES CONNEXES
CONNECTING RODS & RELATED PARTS

Pour les volants
moteurs
voir page 232
*For the flywheel
assy.
see page 232*

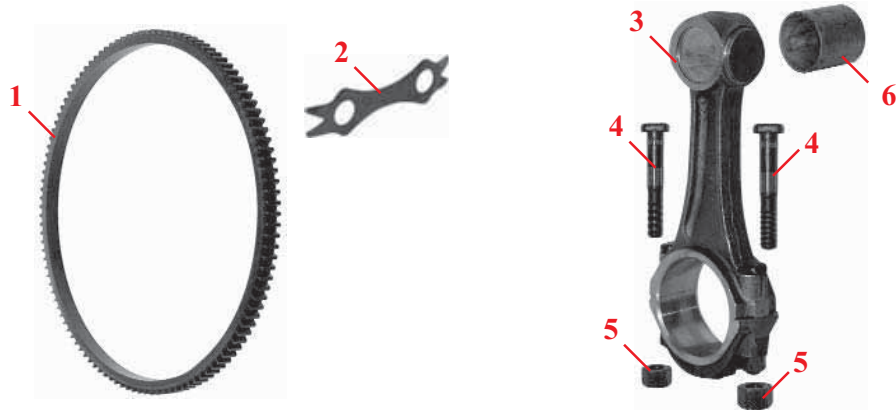

Tracteurs Tractors	Moteur Engine	1 Couronne de démarrage Ring gear	2 Frein de vis Tab washer	3 Bielle Conrod	4 Boulon de bielle Conrod bolt	5 Ecrin de bielle Conrod nut	6 Bague de bielle Small end bush
6 Moteurs 6 cylindres / 6 cylinder engines							
396, 399, 4260, 4270	1006.6 (Blue)	30/15-16 (31161148, 747694M1, 3819720M1)		30/25-3 (ZZ90009, 3637034M91)			30/28-2 (31134123, 733767M1)
3085, 3095, 3115, 6160, 6170	1006.6 (Blue)	30/15-7 (1619032M1)		30/25-11 (ZZ90013, 3637028M91)	30/26-2 (32762145, 4222485M1)	30/27-2 (33221328, 3637030M1)	30/28-16 (31134131, 744971M1)
3120, 3120T, 3125, 3140, 3635, 6180, 6190, 8110, 8120, 8130	1006.6T (Blue)		30/16-1 (0921062, 731192M1)				
3645, 3655, 3660	1006.6T (Blue)						
4260, 4360	1006.60 (Green)	30/15-16 (31161148, 747694M1, 3819720M1)					30/28-40 (3112E005, 4222284M1)
4270, 4370	1006.60T (Green)				30/26-13 (32186142, 4222132M1)		30/28-41 (3112E011, 4222131M1)
6170, 6180, 6290, 8120 6270, 6280, 8210, 8220 <i>Avec compresseur d'air With air compressor</i>	1006.60T (Green)	30/15-7 (1619032M1)					
6260 6270, 6280, 8210, 8220	1006.60 1006.60T				30/26-2 (32762145, 4222485M1)	30/27-2 (33221328, 3637030M1)	

Les références des pièces sont indicatives.
Nos pièces ne sont pas d'origine

Part numbers are quoted for reference purposes only.
Our parts and accessories are not original.



BIELLES & PIÈCES CONNEXES
CONNECTING RODS & RELATED PARTS

Pour les volants
moteurs
voir page 232
*For the flywheel
assy.
see page 232*

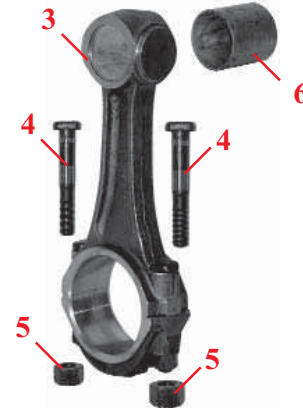

Tracteurs Tractors	Moteur Engine	1 Couronne de démarrage Ring gear	2 Frein de vis Tab washer	3 Bielle Conrod	4 Boulon de bielle Conrod bolt	5 Ecrue de bielle Conrod nut	6 Bague de bielle Small end bush
6 Moteurs 6 cylindres / 6 cylinder engines							
3680, 3690	612DS	30/15-7 (1619032M1)					30/28-26 (3637624M1, V836336297)
							+0.5mm 30/28-32 (3637625M1, V836338606)
3670 8140 (⇒ G331001) 8150 (⇒ G317024)	620DS	30/15-7 (1619032M1)					(⇒ L11211) 30/28-27 (3638959M1, V836646271)
8140 (G331002 ⇒) 8150 (G317025 ⇒) <i>Avec amortisseur / With damper</i>	620DS						
8240	620DSRAE						
8240Xtra	620DWBAE						
3690 8160 (⇒ G331006)	634DS						
8160 (G331007 ⇒) <i>Avec amortisseur / With damper</i>	634DS						
8250, 8260	634DSBAE						
8260	634DSBIE						
8250Xtra, 8260Xtra	634DWBAE						
8170, 8180	645DSBIE	30/15-7 (1619032M1)					(⇒ L01109) 30/28-26 (3637624M1, V836336297)
8270, 8280	645DSBIE						
8270Xtra, 8280Xtra	645DSBAE						+0.5mm 30/28-32 (3637625M1, V836338606)

Les références des pièces sont indicatives.
Nos pièces ne sont pas d'origine

Part numbers are quoted for reference purposes only.
Our parts and accessories are not original.



"THE RELIABLE SERVICE"



BIELLES & PIÈCES CONNEXES
CONNECTING RODS & RELATED PARTS

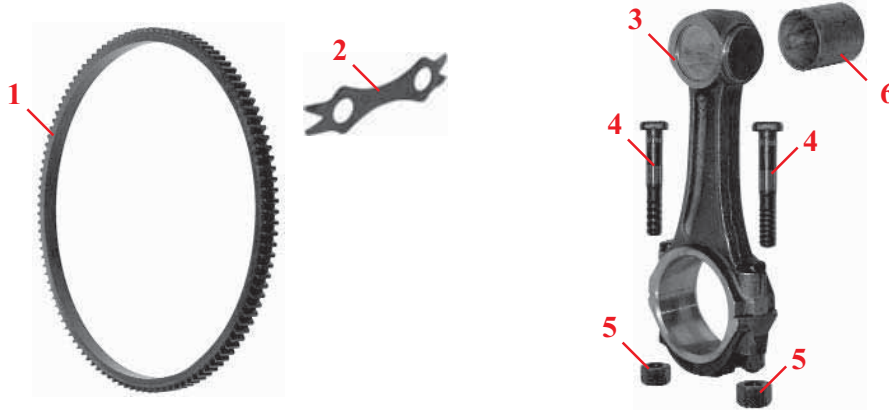

Tracteurs Tractors	Moteur Engine	1 Couronne de démarrage Ring gear	2 Frein de vis Tab washer	3 Bielle Conrod	4 Boulon de bielle Conrod bolt	5 Ecrus de bielle Conrod nut	6 Bague de bielle Small end bush
4 Moissonneuses-batteuses moteurs 4 cylindres / 4 cylinder engines combinées							
186	A4.212	30/15-5 (0410264, 731988M1)	30/16-1 (0921062, 731192M1)	30/25-3 (ZZ90009, 3637034M91)			30/28-2 (31134123, 733767M1)
99, 187, 206, 240, 307	A4.236						
8Plot, 10Plot, 16Plot, 16	A4.236						
330	A4.236	30/15-1 (0410236, 731008M1, 3819719M1)					
20XP	AT4.236	30/15-5 (0410264, 731988M1)		30/25-11 (ZZ90013, 3637028M91)	30/26-2 (32762145, 4222485M1)	30/27-2 (33221328, 3637030M1)	30/28-16 (31134131, 744971M1)
440, 487, 506	A4.248		30/16-1 (0921062, 731192M1)				
20	A4.248			30/25-3 (ZZ90009, 3637034M91)			30/28-2 (31134123, 733767M1)
430	A4.248	30/15-1 (0410236, 731008M1, 3819719M1)					
788	A4.270	30/15-5 (0410264, 731988M1)	30/16-1 (0921062, 731192M1)				30/28-8 (0050128, 731463M1)
400, 410, 415	A4.300						
6 Moissonneuses-batteuses moteurs 6 cylindres / 6 cylinder engines combinées							
500, 507, 510, 515, 520, 525	A6.354	30/15-5 (0410264, 731988M1)	30/16-1 (0921062, 731192M1)	30/25-3 (ZZ90009, 3637034M91)			30/28-2 (31134123, 733767M1)
530, 530S, 535, 800, 805, 810, 815	A6.354.4						
24, 27	A6.354.4	30/15-14 (31162121, 738588M1)					
750, 760	AT6.354.1	30/15-5 (0410264, 731988M1)	30/16-1 (0921062, 731192M1)		30/26-2 (32762145, 4222485M1)	30/27-2 (33221328, 3637030M1)	30/28-16 (31134131, 744971M1)
560, 565, 660, 665, 750, 760, 820, 825, 830, 835, 840, 845, 850, 855, 860	AT6.354.4						
29, 29XP, 31, 31XP	AT6.354.4	30/15-14 (31162121, 738588M1)		30/25-11 (ZZ90013, 3637028M91)			
620, 625, 740, 750	A6.372	30/15-5 (0410264, 731988M1)	30/16-1 (0921062, 731192M1)	30/25-3 (ZZ90009, 3637034M91)			30/28-2 (31134123, 733767M1)
750	A6.372.4						



Les références des pièces sont indicatives.
Nos pièces ne sont pas d'origine

Part numbers are quoted for reference purposes only.
Our parts and accessories are not original.

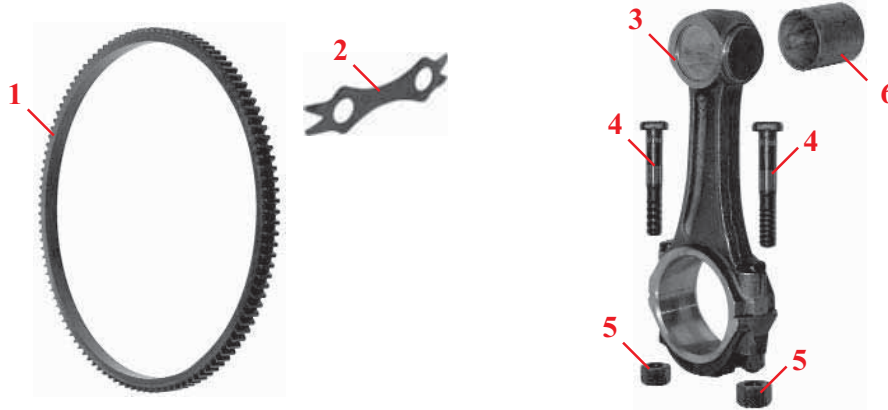

BIELLES & PIÈCES CONNEXES
CONNECTING RODS & RELATED PARTS



		1	2	3	4	5	6
Tracteurs Tractors	Moteur Engine	Couronne de démarrage Ring gear	Frein de vis Tab washer	Bielle Conrod	Boulon de bielle Conrod bolt	Ecrou de bielle Conrod nut	Bague de bielle Small end bush
 Chargeurs télescopiques / Telescopic handlers							
24	A4.236	30/15-1 (0410236, 731008M1, 3819719M1)		30/25-3 (ZZ90009, 3637034M91)			30/28-2 (31134123, 733767M1)
24T	AT4.236			30/25-11 (ZZ90013, 3637028M91)			30/28-16 (31134131, 744971M1)
8925, 8926, 8937, 8939	1004.4 (Blue)	30/15-14 (31162121, 738588M1)		30/25-3 (ZZ90009, 3637034M91)	30/26-2 (32762145, 4222485M1)	30/27-2 (33221328, 3637030M1)	30/28-2 (31134123, 733767M1)
8925, 8926, 8937, 8939	1004.42 (Green)						
8925T, 8926T, 8937T, 8939T	1004.4T (Blue)			30/25-11 (ZZ90013, 3637028M91)			30/28-16 (31134131, 744971M1)
8925T, 8926T, 8937T, 8939T	1004.40T (Green)					30/26-13 (32186142, 4222132M1)	30/28-41 (3112E011, 4222131M1)
 Tracteurs industriels moteurs 3 cylindres / 3 cylinder engine industrial tractors							
203, 205	A3.152	30/15-1 (0410236, 731008M1, 3819719M1)		30/25-1 (ZZ90011, 3637439M91)			30/28-1 (31134151, 740407M1)
20, 40	AG3.152		30/16-1 (0921062, 731192M1)				
20, 20D, 40, 203, 205, 2135, 2203, 2205	AD3.152			30/25-2 (ZZ90010, 3637392M91)	30/26-1 (0095250, 375756X1)	30/27-1 (33221327, 1476245X1)	
20B, 20C, 20E, 20F, 30B, 30E, 30H	AD3.152						
40E	AT3.152.4						

Les références des pièces sont indicatives.
Nos pièces ne sont pas d'origine

Part numbers are quoted for reference purposes only.
Our parts and accessories are not original.



"THE RELIABLE SERVICE"



BIELLES & PIÈCES CONNEXES
CONNECTING RODS & RELATED PARTS

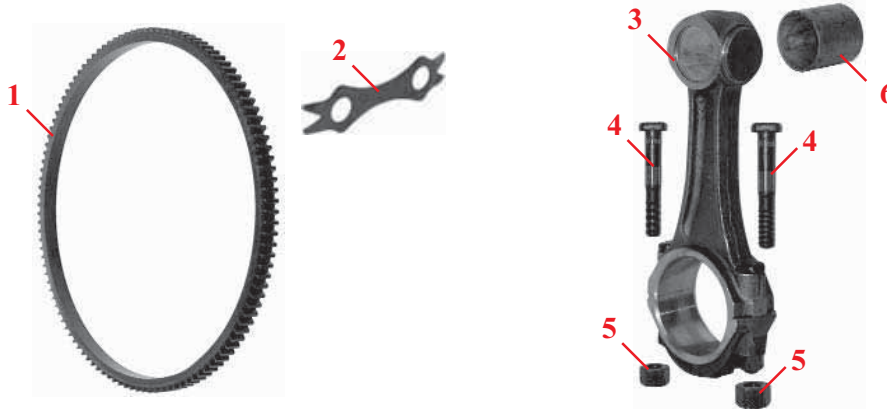

Tracteurs Tractors	Moteur Engine	1 Couronne de démarrage Ring gear	2 Frein de vis Tab washer	3 Bielle Conrod	4 Boulon de bielle Conrod bolt	5 Ecrou de bielle Conrod nut	6 Bague de bielle Small end bush	
Tracteurs industriels moteurs 4 cylindres / 4 cylinder engine industrial tractors								
702	23C Diesel	30/15-15 (826049M1)					30/28-33 (1884944M1)	
356	A4.203	30/15-1 (0410236, 731008M1, 3819719M1)	30/16-1 (0921062, 731192M1)	30/25-1 (ZZ90011, 3637439M91)	30/26-1 (0095250, 375756X1)	30/27-1 (33221327, 1476245X1)	30/28-1 (31134151, 740407M1)	
30, 40B, 50, 302, 304, 356, 3165, 3303, 3305	AD4.203			30/25-2 (ZZ90010, 3637392M91)				
50, 50B, 3303, 3305	A4.212			30/25-3 (ZZ90009, 3637034M91)	30/26-2 (32762145, 4222485M1)	30/27-2 (33221328, 3637030M1)	30/28-2 (31134123, 733767M1)	
50, 50B, 50B MKII, 50C, 60	A4.236			30/25-11 (ZZ90013, 3637028M91)				
30D, 50D, 50E, 50H, 50H-S, 50H-T	A4.236			30/25-3 (ZZ90009, 3637034M91)				
60HX, 60HX-T	AT4.236							30/28-16 (31134131, 744971M1)
50EX, 50HX, 50HX-S, 50HX-T, 60H, 60H-S	A4.248							30/28-2 (31134123, 733767M1)
70	A4.318	30/15-5 (0410264, 731988M1)	30/16-1 (0921062, 731192M1)				30/28-8 (0050128, 731463M1)	
Fermec & Terex - Tracteurs industriels moteurs 4 cylindres / 4 cylinder engine industrial tractors								
750	1004.4 (Blue)	30/15-1 (0410236, 731008M1, 3819719M1)		30/25-3 (ZZ90009, 3637034M91)	30/26-2 (32762145, 4222485M1)	30/27-2 (33221328, 3637030M1)	30/28-2 (31134123, 733767M1)	
750, 750B	1004.42 (Green)			30/25-11 (ZZ90013, 3637028M91)			30/28-41 (3112E011, 4222131M1)	
760, 860, 860S, 860SE, 865, 960, 965	1004.4T (Blue)							30/28-16 (31134131, 744971M1)
760, 760B, 860, 860B, 860S, 860SE, 960, 960B, 965	1004.40T (Green)					30/26-13 (327186142, 4222132M1)		

Les références des pièces sont indicatives.
Nos pièces ne sont pas d'origine

Part numbers are quoted for reference purposes only.
Our parts and accessories are not original.



"THE RELIABLE SERVICE"



JEUX DE REVISION MOTEUR ENGINE OVERHAUL KITS

Comprenant : Pistons, segments & chemises
Bagues avant et arrière
Bagues et boulons de bielle
Pochette rôdage
Pochette complémentaire

Contents : *Pistons, rings & liners*
Front & rear oil seals
Conrod bushes & nuts
Top & bottom gasket sets

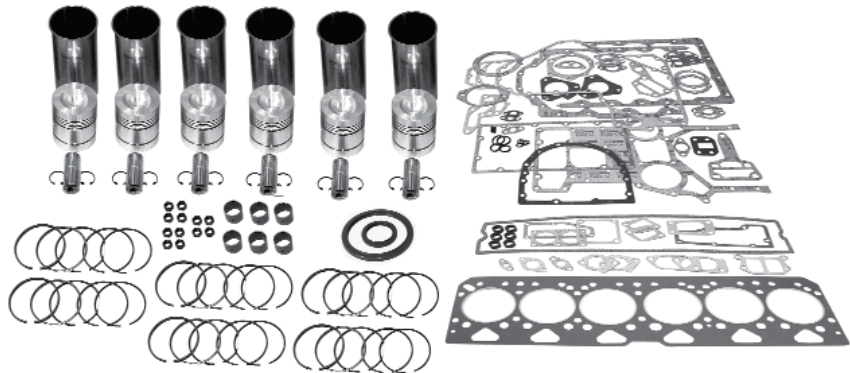

Moteur Engines	Jeu de révision / Overhaul kit	
	Avec chemise finie With finished liner	Avec chemise semi-finie With semi-finished liner
A3.144		30/30-181S (A) (U5MK0321, 3638892M91)
A3.152 (Chemise chromée / Chrome liner)	30/30-100 (U5MK0290, 3639495M1)	
A3.152 (Chemise acier / Cast iron liner)	30/30-101 (U5MK0291, 3639496M1)	30/30-101S (B30101S)
AD3.152 (Pistons 5 segments / 5 ring piston)	30/30-102 (A) (U5MK0292, U5MK0701, 3638583M91, 4223470M91)	30/30-102S (A) (U5MK0701K)
AD3.152 (Pistons 4 segments / 4 ring piston)	30/30-103 (A) (U5MK0288, U5MK0700, 3638581M91)	30/30-103S (A) (U5MK0700K)
AT3.152.4		30/30-105S (U5MK0277, 3639486M1)
A4.107	30/30-106 (U5MK0289, 3639494M1)	
AD4.203	30/30-107 (A) (U5MK0293, 3638495M91)	30/30-107S (A) (B30107S)
A4.212	30/30-108 (A) (U5MK0294, 3638584M91)	30/30-108S (A) (B30108S)
A4.236 (⇒ U106653N) Premiers blocs alésage 103.19mm - Chemise Avec anneau pare-flamme Early blocks 103.19mm bore Ø - Liner with flame ring	30/30-110 (A) (U5MK0281, U5MK0704, 3638582M91)	30/30-110S (A) (U5MK0704K)
A4.236 (U106653N ⇒) Derniers blocs alésage 104.20mm - Chemise Sans anneau pare-flamme Later blocks 104.20mm bore Ø - Liner without flame ring	30/30-111 (U5MK0278, U5MK0713, 3639487M1)	30/30-111S (U5MK0713K)
AT4.236 (⇒ U027773M) Premiers blocs alésage 103.19mm - Chemise Avec anneau pare-flamme Early blocks 103.19mm bore Ø - Liner with flame ring	30/30-112 (U5MK0280, 3639489M1)	30/30-112S (B30112S)
AT4.236 (U027774M ⇒) Derniers blocs alésage 104.20mm - Chemise Sans anneau pare-flamme Later blocks 104.20mm bore Ø - Liner without flame ring	30/30-113 (U5MK0282, U5MK0705, 3639490M1, 4222076M91)	30/30-113S (U5MK0705K)

(A) Les jeux comprennent les bagues arrière 2 pièces et 1 pièce.
The kit includes both rope and lip rear oil seals

NB Les soupapes et pieces connexes ne sont pas comprises dans ces jeux. Pour les détails des jeux de soupapes voir page MF-60
Valve components are not included in these kits. For details of valve train kits see page MF-60



Les composants de nos kits ne doivent pas être mélangés a des composants plus anciens.
Ces kits sont de stock mais nous serons heureux de réaliser pour vous des kits selon vos besoins.
The components within these kits should not be mixed with older components.
These kits are stock items. We are happy to make up kits to your requirements.

Les références des pièces sont indicatives.
Nos pièces ne sont pas d'origine

Part numbers are quoted for reference purposes only.
Our parts and accessories are not original.



"THE RELIABLE SERVICE"



JEUX DE REVISION MOTEUR ENGINE OVERHAUL KITS

Comprenant : Pistons, segments & chemises
Bagues avant et arrière
Bagues et boulons de bielle
Pochette rôdage
Pochette complémentaire

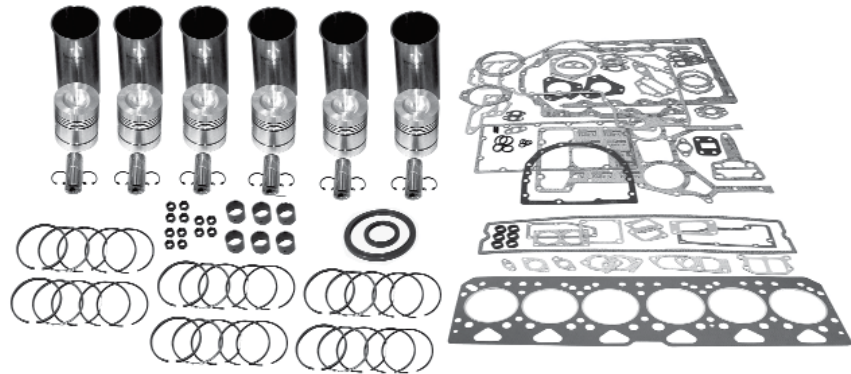

Contents : *Pistons, rings & liners
Front & rear oil seals
Conrod bushes & nuts
Top & bottom gasket sets*

Moteur Engines	Jeu de révision / Overhaul kit	
	Avec chemise finie With finished liner	Avec chemise semi-finie With semi-finished liner
A4.248 (Chemise parallèle / Parallel liner)		30/30-114S (A) (U5MK0287, 3638580M91)
A4.248 (⇒ U108196N) Chemise Avec anneau pare-flamme / Liner with flame ring	30/30-115 (A) (U5MK0155, U5MK0706, 3637612M91, 4222356M91)	30/30-115S (A) (U5MK0706K)
A4.248 (U108197N ⇒) Chemise Sans anneau pare-flamme / Liner without flame ring	30/30-116 (U5MK0279, 3638585M91)	30/30-116S (B30116S)
A4.318.2	30/30-117 (A) (U5MK0295, 3638586M91)	30/30-117S (A) (B30117S)
A4.41	30/30-186 (4222910M91)	30/30-186S (B30186S)
A6.354.4	30/30-118 (U5MK0283, U5MK0710, 3639491M1, 4224394M91)	30/30-118S (U5MK0710K)
AT6.354.4	30/30-119 (U5MK0284, U5MK0711, 3639492M1)	30/30-119S (U5MK0711K)
1004.4 (Blue)	30/30-182 (U5MK0708)	30/30-182S (U5MK0708K)
1004.4T (Blue)	30/30-183 (U5MK0709, 4222909M91)	30/30-183S (U5MK0709K)
1006.6 (Blue)	30/30-184 (U5MK0319, U5MK0714, 3931493M91)	30/30-184S (U5MK0714K)
1006.6T (Blue)	30/30-185 (U5MK0320, U5MK0712, 4222908M91)	30/30-185S (U5MK0712K)

(A) Les jeux comprennent les bagues arrières 2 pièces et 1 pièce.
The kit includes both rope and lip rear oil seals

NB Les soupapes et pieces connexes ne sont pas comprises dans ces jeux. Pour les détails des jeux de soupapes voir page MF-60
Valve components are not included in these kits. For details of valve train kits see page MF-60



Les composants de nos kits ne doivent pas être mélangés a des composants plus anciens.
Ces kits sont de stock mais nous serons heureux de réaliser pour vous des kits selon vos besoins.
*The components within these kits should not be mixed with older components.
These kits are stock items. We are happy to make up kits to your requirements.*

Les références des pièces sont indicatives.
Nos pièces ne sont pas d'origine

*Part numbers are quoted for reference purposes only.
Our parts and accessories are not original.*



PISTONS, JEUX DE SEGMENTS & CHEMISES
PISTONS, RING SETS & LINERS

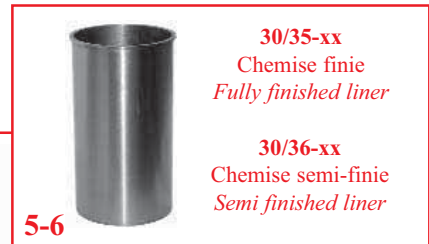
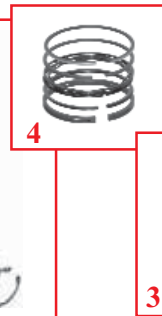

30/35-xx
Chemise finie
Fully finished liner

30/36-xx
Chemise semi-finie
Semi finished liner

	1	2	3	4	5	6	
Tracteurs Tractors	Moteur Engine	Jeu Kit set	Piston & segm. Piston & rings	Piston & Axe Piston & pin	Jeu segments Ring set	Chemise finie Finished liner	Chemise semi-finie Semi-finished liner
3 Moteurs 3 cylindres / 3 cylinder engines							
35, 133, 135	A3.144	30/31-3 (B1129)	30/32-3 (55275)	30/33-3 (55274, 739845M91)	30/34-3 (41158063, 745823M91)	30/35-3 (0530017)	30/36-3 (0530002, 731595M1)
35 Chemise chrome Chrome liner	A3.152	30/31-4 (U5MK0064, 3639471M1)	30/32-4 (68503, 3640441M91)	30/33-4 (A) (81512, 734460M91)	30/34-4 (41158058, 745819M91)	30/35-4 (31358308, 732638M1)	
35 Chemise acier Cast iron liner	A3.152	30/31-5 (U5MK0033, 3640482M91)	30/32-5 (68502, 3639047M1)		30/34-7 (41158057, 745818M91)		
135	AG3.152	30/31-11 (B3111)	30/32-11 (B3211)	30/33-11 (86723, 738287M91)	30/34-11 (41158012, 745815M91)		
133, 134, 135, 140, 145, 150, 230, 233, 234, 235, 240, 245, 333, 334V, 340 354 (CE31223, CE31224)	AD3.152	30/31-7 (U5MK0034, 3637428M91)	30/32-7 (68504, 3639048M1)	30/33-7 (68332, 743824M91)	30/34-7 (41158057, 745818M91)	30/35-7 (31358345, 739043M1)	30/36-7 (31358323, 734179M1)
148, 152, 154, 235 (USA), 244CF, 245 (USA), 250, 253 (Italy), 254, 255, 342, 350, 550, 2205	AD3.152	30/31-8 (U5MK0117, 3638883M91)	30/32-8 (U5PR0002)	30/33-8 (89214, 742621M91)	30/34-8 (41158065, 745826M91)		
353, 354 (CE31197, CE31212) 356CF, 3210 Chemise a colerette Flanged liner	AD3.152						
353, 354 (CE31197, CE31212) 356CF, 3210 Chemise droite / Parallel liner	AD3.152	30/31-81S (B3181S)					30/36-24 (31358356, 3637492M1)
164T, 263T, 264T, 352	AT3.152.4	30/31-140 (B31140)	30/32-72 (B3272)	30/33-72 (U5LL0044, 4224456M91)	30/34-71 (H) (41158144, 3637658M91)	30/35-7 (31358345, 739043M1)	30/36-7 (31358323, 734179M1)
253 (UK), 355, 360, 363, 364, 366CF Chemise a colerette Flanged liner	AT3.152.4						
253 (UK), 355, 360, 363, 364, 366CF Chemise droite / Parallel liner	AT3.152.4						
2210, 3315, 4215, 4315	903.27	30/31-177S (B31177S)	30/32-177 (B32177)	30/33-177 (F) (U5LH0006, 4223808M91)	30/34-177 (4181A035, 4222577M91)		30/36-177 (3135P001, 4222570M91)
263 (UK), 2220, 3325, 4220, 4320	903.27T	30/31-178S (B31178S)	30/32-178 (B32178)	30/33-178 (G) (U5LH0007, 4224102M91)	30/34-178 (4181A051, 4222723M91)		

(A) Piston avec hauteur à rectifier disponible 30/33-5 équivalent à 68306, 743121M91.

Untopped piston available 30/33-5 equivalent to 68306, 743121M91.

(F) Piston de qualité supérieure, remplace / High grade piston, replace U5LL0030, 4223809M91

(G) Piston de qualité supérieure, remplace / High grade piston, replace U5LL0029, 4222722M91

(H) 30/34-71 est nécessaire avec le piston U5LP0017, 3637513M91 monté sur : / 30/34-71 is required for piston U5LP0017, 3637513M91 that fitted :
164T, 253 (UK) (CN31219), 263T (Italy), 264T, 355 & 360 (CN31187).

Piston U5LP0017, 3637513M91 est remplacé par / is replaced by 30/33-72 + 30/34-72

Les références des pièces sont indicatives.
Nos pièces ne sont pas d'origine

Part numbers are quoted for reference purposes only.
Our parts and accessories are not original.



PISTONS, JEUX DE SEGMENTS & CHEMISES
PISTONS, RING SETS & LINERS

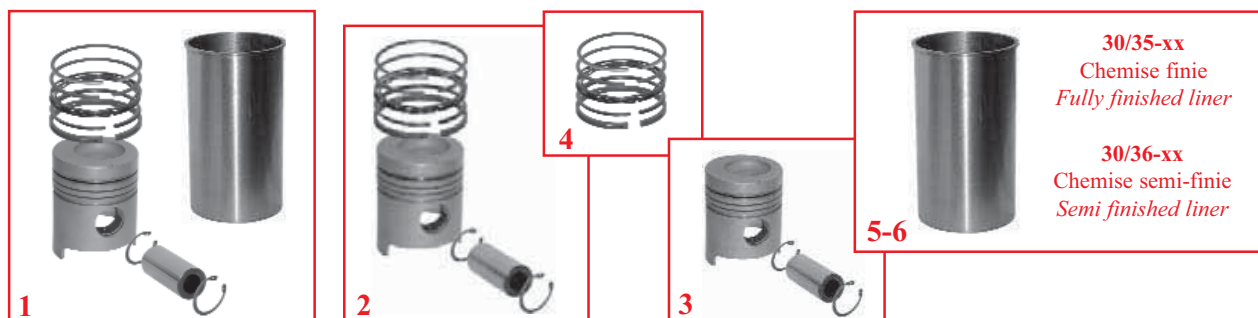

		1	2	3	4	5	6
Tracteurs Tractors	Moteur Engine	Jeu Kit set	Piston & segm. Piston & rings	Piston & Axe Piston & pin	Jeu segments Ring set	Chemise finie Finished liner	Chemise semi-finie Semi-finished liner
4 Moteurs 4 cylindres / 4 cylinder engines							
TEA20 TED20 TEH20	85mm Petrol 85mm VO 85mm LO	30/31-40 (B) (883013M91)	30/32-40 (200570)	30/33-40 (B1206)	30/34-40 (B1216)	30/35-40 (893007M1)	
TEF20	20C Diesel	30/31-1 (883015M91)	30/32-1 (115741F)	30/33-1 (B1208)	30/34-1 (B1218)	30/35-1 (106594F)	
FE35, 835	23C Diesel	30/31-2 (830972M92)	30/32-2 (B1199)	30/33-2 (1884101M91)	30/34-2 (894900M91)	30/35-2 (1884940M1)	
35, 135	87mm Petrol	30/31-41 (B) (B1125)	30/32-41 (826276M91)	30/33-41 (B1209)	30/34-41 (B1219)	30/35-41 (825861M1)	
25, 30, 130, 825	A4.107	30/31-16 (U5MK0036, 3637429M91)	30/32-16 (68517)	30/33-16 (89216, 741335M91)	30/34-16 (41158085, 745902M91)	30/35-16 (31358116, 734127M1)	
65	A4.192	30/31-3 (B1129)	30/32-3 (55275)	30/33-3 (55274, 739845M91)	30/34-3 (41158063, 745823M91)	30/35-3 (0530017)	30/36-3 (0530002, 731595M1)
65, 865 Chemise chrome Chrome liner	A4.203	30/31-4 (U5MK0064, 3639471M1)	30/32-4 (68503, 3640441M91)	30/33-4 (A) (81512, 734460M91)	30/34-4 (41158058, 745819M91)	30/35-4 (31358308, 732638M1)	
65, 865 Chemise acier Cast iron liner	A4.203	30/31-5 (U5MK0033, 3640482M91)	30/32-5 (68502, 3639047M1)		30/34-7 (41158057, 745818M91)	30/35-7 (31358345, 739043M1)	30/36-7 (31358323, 734179M1)
65, 765 Chemise chrome Chrome liner	AD4.203	30/31-6 (59582)	30/32-6 (82137)	30/33-7 (68332, 743824M91)	30/34-4 (41158058, 745819M91)	30/35-4 (31358308, 732638M1)	
65, 165, 765, 155, 158, 158MKIII, 260, 560 (⇒ U589378L) Chemise acier Cast iron liner	AD4.203	30/31-7 (U5MK0034, 3637428M91)	30/32-7 (68504, 3639048M1)		30/34-7 (41158057, 745818M91)	30/35-7 (31358345, 739043M1)	30/36-7 (31358323, 734179M1)
155, 158, 158MKIII, 260, 560 (U589379L ⇒) Chemise acier Cast iron liner	AD4.203	30/31-8 (U5MK0117, 3638883M91)	30/32-8 (U5PR0002)	30/33-8 (89214, 742621M91)	30/34-8 (41158065, 745826M91)		

(A) Piston avec hauteur à rectifier disponible 30/33-5 équivalent à 68306, 743121M91.
Untopped piston available 30/33-5 equivalent to 68306, 743121M91.

(B) Les jeux 30/31-40 & 30/31-41 sont fournis complets avec le joint torique.
30/31-40 & 30/31-41 kit sets are supplied complete with spectacle gasket.

Les références des pièces sont indicatives.
Nos pièces ne sont pas d'origine

Part numbers are quoted for reference purposes only.
Our parts and accessories are not original.



PISTONS, JEUX DE SEGMENTS & CHEMISES
PISTONS, RING SETS & LINERS

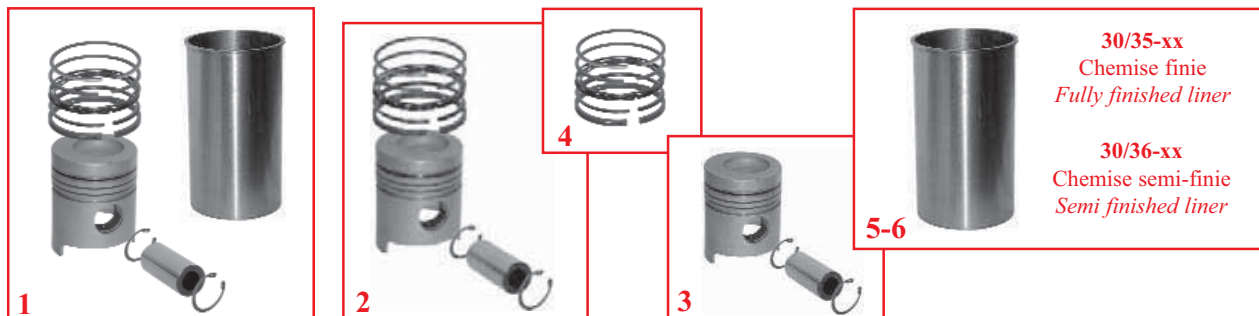

	1	2	3	4	5	6	
Tracteurs Tractors	Moteur Engine	Jeu Kit set	Piston & segm. Piston & rings	Piston & Axe Piston & pin	Jeu segments Ring set	Chemise finie Finished liner	Chemise semi-finie Semi-finished liner
4 Moteurs 4 cylindres / 4 cylinder engines							
165 (Bague arr. 2 pcs / Rope seal) 3 segments / 3 ring piston	A4.212	30/31-10 (B1102)	30/32-10 (68515)	30/33-10 (89206, 740082M91)	30/34-10 (41158045, 745764M91)		
165, 174 (Bague arr. 1 pc / Lip seal) 4 segments / 4 ring piston	A4.212	30/31-9 (U5MK0066, 3637432M91)	30/32-9 (68514, 1896435M91)	30/33-9 (86721, 738249M91)	30/34-9 (41158044, 745763M91)		
168, 175, 184 (Bague arr. 2 pcs / Rope seal)	A4.236	30/31-12 (U5MK0038, 3637430M91)	30/32-12 (68506, 3640442M91)	30/33-12 (82878, 735187M91)		30/35-14 (31358394, 744948M1)	30/36-14 (31358393, 744131M1)
168, 175, 184 (Bague arr. 1 pc / Lip seal) 174, 255 (USA), 265, 273, 274, 275, 283, 284, 565, 575, 675, 3050 Premiers blocs alésage 103.19mm Early blocks 103.19mm bore Ø	A4.236	30/31-14 (U5MK0171, 3638888M91)					
168, 174, 184, 255 (USA), 265, 273, 274, 275, 283, 284, 565, 575, 675, 3050 Demiers blocs alésage 104.20mm Later blocks 104.20mm bore Ø	A4.236	30/31-69 (U5MK0286)	30/32-69 (68516, 3639051M1)	30/33-69 (68301, U5LP0035, 743110M91, 3637516M91)	30/34-12 (41158041, 745760M91)	30/35-22 (3135X032, 3637332M1)	30/36-22 (3135X031, 3637331M1)
168 MKIII, 275E, 362, 362N, 365, 367CF, 372N, 373, 374, 375, 375E, 376C, 377, 383, 384, 387, 3220, 3225	A4.236						
698T, 1004T (⇒ U027773M) Premiers blocs alésage 103.19mm Early blocks 103.19mm bore Ø	AT4.236	30/31-60 (B3160)				30/35-14 (31358394, 744948M1)	30/36-14 (31358393, 744131M1)
393TLX, 394TAQ, 396CT, 397T, 698T, 1004T, 3065 (⇒ U027773M) Demiers blocs alésage 104.20mm Later blocks 104.20mm bore Ø	AT4.236	30/31-73 (B3173)	30/32-73 (B3273)	30/33-73 (U5LP0006, 3639434M1)	30/34-78 (41158005, 745277M91)		
393TLX, 394TAQ, 396CT, 397T, 698T, 1004T, 3065 (U027774M ⇒) 390T, 398, 1007, 3065S, 3070	AT4.236	30/31-74 (U5MK0169)	30/32-74 (U5PR0025, 3639514M1)	30/33-74 (U5LP0022, 3637360M91)	30/34-74 (4181A022, 3638721M91)	30/35-22 (3135X032, 3637332M1)	30/36-22 (3135X031, 3637331M1)

Les références des pièces sont indicatives.
Nos pièces ne sont pas d'origine

Part numbers are quoted for reference purposes only.
Our parts and accessories are not original.



"THE RELIABLE SERVICE"



PISTONS, JEUX DE SEGMENTS & CHEMISES
PISTONS, RING SETS & LINERS

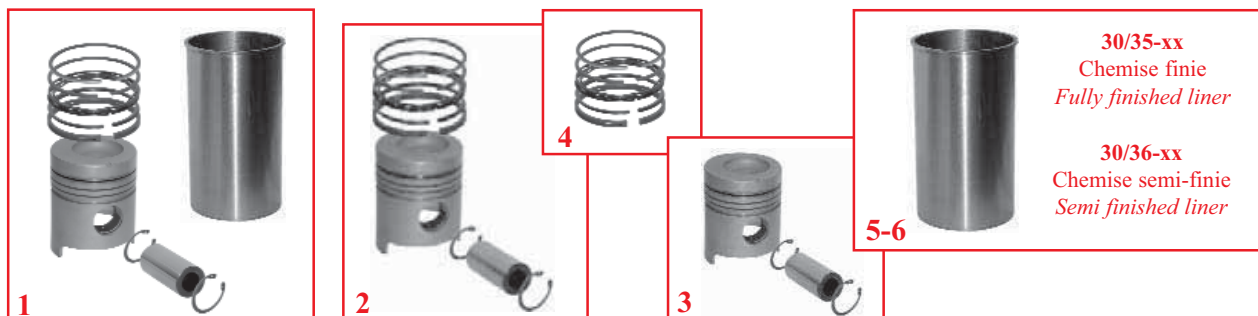

	1	2	3	4	5	6	
Tracteurs Tractors	Moteur Engine	Jeu Kit set	Piston & segm. Piston & rings	Piston & Axe Piston & pin	Jeu segments Ring set	Chemise finie Finished liner	Chemise semi-finie Semi-finished liner
4 Moteurs 4 cylindres / 4 cylinder engines							
178, 185, 188	A4.248	30/31-13S (U5MK0039, 3637431M91)	30/32-13 (68508, 3639050M1)	30/33-13 (89207, 740821M91)	30/34-13 (4181A009, 747041M91)		30/36-13 (31358343, 737214M1)
194, 285, 290, 293, 294, 590, 690 (⇒ U839079J) <i>Piston 4 segments / 4 ring piston</i>	A4.248	30/31-15 (U5MK0067, 3638866M91)					
194, 285, 290, 293, 294, 590, 690 (U839080J ⇒) <i>Piston 3 segments / 3 ring piston Avec anneau pare-flamme With flame ring</i>	A4.248	30/31-57 (B1126)				30/35-15 (31358352, 742466M1)	30/36-15 (31358346, 740571M1)
194, 290, 290E, 293, 294, 382N, 390, 390E, 393, 394, 396C, 397, 3055, 3060, 3235 <i>Sans anneau pare-flamme Without flame ring</i>	A4.248	30/31-58 (B3158)	30/32-57 (B1226)	30/33-57 (U5LP0009, 747050M91)	30/34-57 (41158022, 747428M91)	30/35-23 (3135X034, 3637334M1)	30/36-23 (3135X033, 3637333M1)
285 (USA), 592, 595, 1080, 1085	A4.318	30/31-21 (B1111)	30/32-21 (B1211)	30/33-21 (86716, 738106M91)	30/34-21 (41158118, 745950M91)	30/35-21 (31358534, 745991M1)	30/36-21 (31358533, 745990M1)
285 (USA), 298, 592, 595, 698, 1004	A4.318.2	30/31-59 (U5MK0029, 746792M91)	30/32-59 (U5PR0045)	30/33-59 (68810, 746251M91)	30/34-59 (41158132, 746163M91)		
275E, 290E, 375E, 390E, 4225, 4235, 4240, 6110, 6120	A4.41 (Blue)	30/31-183 (B31183)	30/32-183 (B32183)	30/33-183 (U5LL0031, 4223499M91)	30/34-183 (4115Y001, 4222053M91)	30/35-23 (3135X034, 3637334M1)	30/36-23 (3135X033, 3637333M1)
3075, 6130, 6140, 6150 4245, 4255 (⇒ U947668E)	1004.4T (Blue)	30/31-108 (U5MK0275, 3640333M91)	30/32-108 (U5PR0040, 3640334M91)	30/33-108 (U5LL0014, 3640593M91)	30/34-108 (4181A026, 3641316M91)	30/35-108 (3135X042, 748216M1)	30/36-108 (3135X041, 748215M1)
4245, 4255 (U947669E ⇒)	1004.4T (Blue)	30/31-179 (B31179)	30/32-179 (B32179)	30/33-179 (U5LL0039, 4223849M91)			
374, 3220, 3330, 4225, 4325	1004.40 (Green)						
3350, 3355, 4235, 4245, 4255, 4345, 4355, 6235, 6245, 6255	1004.40T (Green)	30/31-173 (B31173)	30/32-173 (U5PR0054)	30/33-173 (U5LP0057, 4222134M91)	30/34-173 (4181A033, 4222136M91)	30/35-173 (3135X062, 4222128M1)	30/36-173 (3135X063, 4222129M1)
4265, 4365, 6265	1004.40 TW						
394, 2230, 3235, 3240, 4235 (USA), 4335	1004.42 (Green)		30/32-182 (B32182)	30/33-182 (U5LP0058, 4222949M91)	30/34-182 (4181A045, 4222950M91)		

Les références des pièces sont indicatives.
Nos pièces ne sont pas d'origine

Part numbers are quoted for reference purposes only.
Our parts and accessories are not original.



"THE RELIABLE SERVICE"



PISTONS, JEUX DE SEGMENTS & CHEMISES
PISTONS, RING SETS & LINERS

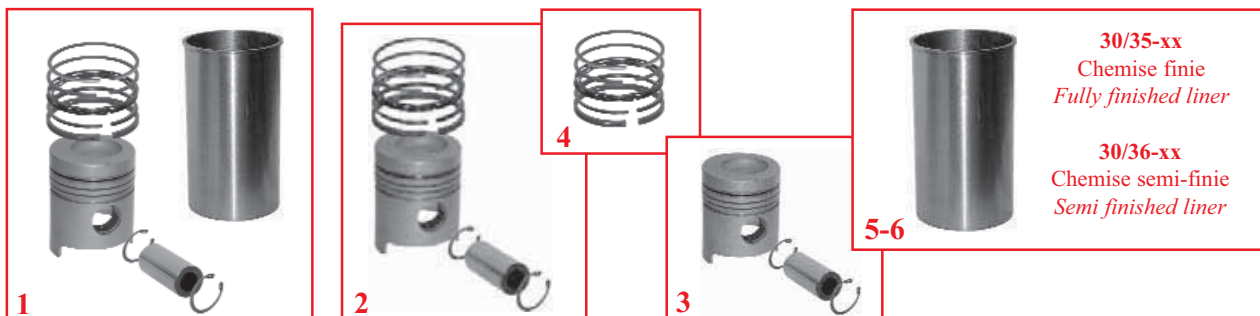

	1	2	3	4	5	6			
Tracteurs Tractors	Moteur Engine	Jeu Kit set	Piston & segm. Piston & rings	Piston & Axe Piston & pin	Jeu segments Ring set	Chemise finie Finished liner	Chemise semi-finie Semi-finished liner		
6 Moteurs 6 cylindres / 6 cylinder engines									
1100 1014, 1104 Segments std / Std ring set	A6.354 A6.354.1	30/31-70 (U5MK0127, 3638885M91)	30/32-22 (68509, 3641196M91)	30/33-18 (86740, 738871M91)	30/34-12 (C) (41158041, 745760M91)	30/35-14 (31358394, 744948M1)	30/36-14 (31358393, 744131M1)		
1100 1014, 1104 Segments Duaflex ring set	A6.354 A6.354.1	30/31-18 (B1114)	30/32-18 (68510)		30/34-18 (41158029, 745750M91)				
1200	A6.354.1	30/31-24 (U5MK0125)	30/32-24 (68512, 3641425M91)		30/33-24 (86745, 3637280M91)			30/34-24 (41158032, 745752M91)	
1014 (TW31087 ⇒ U725809L) 2620, 2625 (⇒ U653769H)	A6.354.4	30/31-70 (U5MK0127, 3638885M91)	30/32-22 (68509, 3641196M91)	30/33-18 (86740, 738871M91)	30/34-12 (41158041, 745760M91)				
399, 699 1014 (TW31087 U725810L ⇒) 1014 (TW31147) 1024, 1114, 1250 2620, 2625 (U653770H ⇒) 2640, 2645, 2675, 3080, 3090, 3610	A6.354.4	30/31-77 (B3177)	30/32-77 (B3277)	30/33-77 (U5LP0021, 748266M91)	30/34-75 (41158017, 745738M91)				
1105 1130 1135	ATC6.354.1 AT6.354 AT6.354.1	30/31-23 (B1123)	30/32-23 (B1223)	30/33-23 (86726, 738368M91)	30/34-23 (41158031, 745751M91)				
1134, 2680, 2685, 2705, 2720, 2725, 3630, 3650	AT6.354.4	30/31-78 (U5MK0071, 3637766M91)	30/32-78 (U5PR0011, 3641413M91)	30/33-78 (68803, 745379M91)	30/34-78 (41158005, 745277M91)				
396, 399, 4260, 4270 (⇒ U593765A) 3085, 3095, 3115, 6160, 6170 (⇒ U646982C)	1006.6 (Blue)	30/31-109 (U5MK0142, 3637661M91)	30/32-109 (U5PR0016, 3637662M91)	30/33-109 (U5LL0015, 3638989M91)	30/34-110 (4181A019, 3637033M91)			30/35-108 (3135X042, 748216M1)	30/36-108 (3135X041, 748215M1)
396, 399, 4260, 4270 (U593766A ⇒) 3085, 3095, 3115, 6160, 6170 (U646983C ⇒)	1006.6 (Blue)	30/31-176 (B31176)	30/32-176 (B32176)	30/33-176 (U5LL0021, 3641806M91)	30/34-176 (4181A041, 4222706M91)				

(C) Aussi disponible : Segments 30/34-12T (41158026, 745747M91)
Alternative ring available 30/34-12T equivalent to 41158026, 745747M91

Les références des pièces sont indicatives.
Nos pièces ne sont pas d'origine

Part numbers are quoted for reference purposes only.
Our parts and accessories are not original.



PISTONS, JEUX DE SEGMENTS & CHEMISES
PISTONS, RING SETS & LINERS

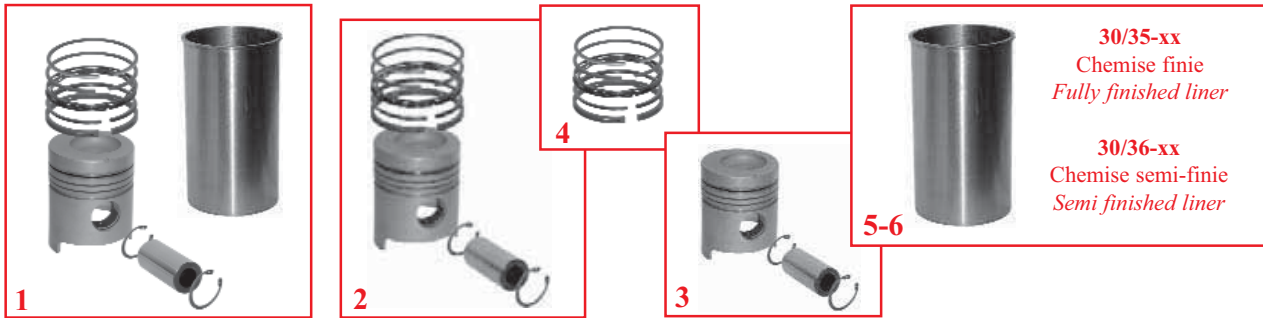

	1	2	3	4	5	6	
Tracteurs Tractors	Moteur Engine	Jeu Kit set	Piston & segm. Piston & rings	Piston & Axe Piston & pin	Jeu segments Ring set	Chemise finie Finished liner	Chemise semi-finie Semi-finished liner
6 Moteurs 6 cylindres / 6 cylinder engines							
3120, 3120T, 3125, 3140, 3635, 3645, 3655, 3660, 6180, 6190, 8110, 8120, 8130	1006.6T (Blue)	30/31-108 (U5MK0275, 3640333M91)	30/32-108 (U5PR0040, 3640334M91)	30/33-108 (U5LL0014, 3640593M91)	⇒ U557976X 30/34-90 (D) (4181A021, 3637032M91) U557977X ⇒ 30/34-108 (4181A026, 3641316M91)	30/35-108 (3135X042, 748216M1)	30/36-108 (3135X041, 748215M1)
4260, 4360, 6260	1006.60 (Green)	30/31-173 (B31173)	30/32-173 (U5PR0054)	30/33-173 (U5LP0057, 4222134M91)	30/34-173 (4181A033, 4222136M91)	30/35-173 (3135X062, 4222128M1)	30/36-173 (3135X063, 4222129M1)
4270, 4370, 6170, 6180, 6270, 6280, 6290, 8120, 8210, 8220	1006.60T (Green)						
3680, 3690	612DS				30/34-175 (V836339201, 3637620M91)		30/37-175 (2xV835336903+ 1xV835322233, 2x3637623M1+ 1x3637622M1)
3670, 8140, 8150	620DS	30/31-174 (B31174)	30/32-174 (B32174)	30/33-174 (V836640073 3638609M1)	30/34-174 (V836640078, 3638610M91)	30/35-174 (V836647420, 3638970M1)	30/37-174 (2xV836647502+ 1xV836647503)
8240	620DSRAE						
8240Xtra	620DWBAE						
3690, 8160	634DS						
8250, 8260	634DSBAE						
8260	634DSBIE						
8250Xtra, 8260Xtra	634DWBAE						

(D) 30/34-90 est utilisé avec le piston U5LL0013, 3638796M91 monté sur les premières versions des séries 3100 et 3600.
Remplacé par 30/33-108+30/34-108
30/34-90 is required for piston U5LL0013, 3638796M91 that fitted early versions of the 3100 and 3600 series tractors.
Piston U5LL0013, 3638796M91 is replaced by 30/33-108+30/34-108

Les références des pièces sont indicatives.
Nos pièces ne sont pas d'origine

Part numbers are quoted for reference purposes only.
Our parts and accessories are not original.



PISTONS, JEUX DE SEGMENTS & CHEMISES
PISTONS, RING SETS & LINERS

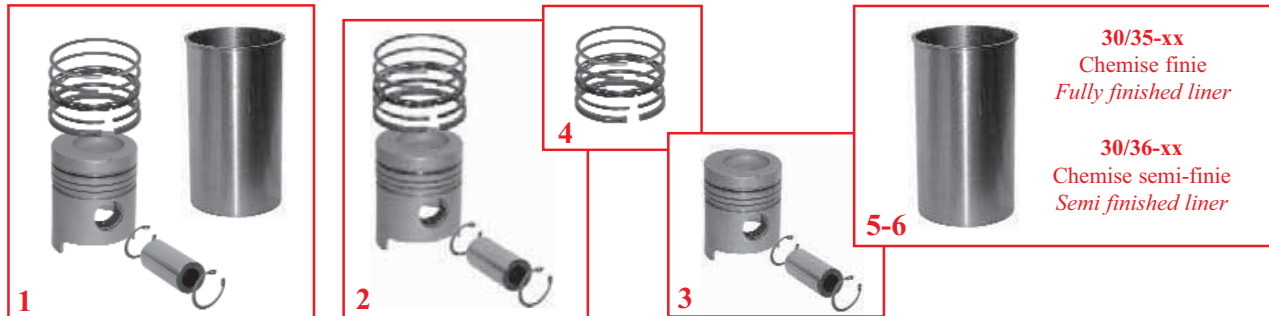

		1	2	3	4	5	6
Tracteurs Tractors	Moteur Engine	Jeu Kit set	Piston & segm. Piston & rings	Piston & Axe Piston & pin	Jeu segments Ring set	Chemise finie Finished liner	Chemise semi-finie Semi-finished liner
4 Moissonneuses-batteuses moteurs 4 cylindres / 4 cylinder engines combines							
186	A4.212	30/31-200S (B31200S)	30/32-9 (68514, 1896435M91)	30/33-9 (86721, 738249M91)	30/34-9 (41158044, 745763M91)		
99, 187 206, 307 (Bague arr. 2 pcs / Rope seal)	A4.236	30/31-201S (U5MK0037, 3639468M1)	30/32-12 (68506, 3640442M91)	30/33-12 (82878, 735187M91)	30/34-12 (41158041, 745760M91)		30/36-18 (31358324, 734644M1)
8Plot, 10Plot, 16Plot, 16 206, 307 (Bague arr. 1 pc / Lip seal) 240, 330	A4.236	30/31-202S (U5MK0065, 3639472M1)	30/32-69 (68516, 3639051M1)	30/33-69 (68301, U5LP0035, 743110M91, 3637516M91))			
20XP (⇒ U027773M) Premiers blocs alésage 103.19mm Early blocks 103.19mm bore Ø	AT4.236	30/31-60 (B3160)	30/32-73 (B3273)	30/33-73 (U5LP0006, 3639434M1)	30/34-78 (41158005, 745277M91)	30/35-14 (31358394, 744948M1)	30/36-14 (31358393, 744131M1)
20XP (⇒ U027773M) Demiers blocs alésage 104.20mm Later blocks 104.20mm bore Ø	AT4.236	30/31-73 (B3173)		30/35-22 (3135X032, 3637332M1)		30/36-22 (3135X031, 3637331M1)	
20XP (U027774M ⇒)	AT4.236	30/31-74 (U5MK0169)	30/32-74 (U5PR0025, 3639514M1)	30/33-74 (U5LP0022, 3637360M91)	30/34-74 (4181A022, 3638721M91)		
440, 487, 506	A4.248	30/31-13S (U5MK0039, 3637431M91)	30/32-13 (68508, 3639050M1)	30/33-13 (89207, 740821M91)	30/34-13 (4181A009, 747041M91)		30/36-13 (31358343, 737214M1)
430	A4.248	30/31-203S (B31203S)					
20 Avec anneau pare-flamme With flame ring	A4.248	30/31-57 (B1126)	30/32-57 (B1226)	30/33-57 (U5LP0009, 747050M91)	30/34-57 (41158022, 747428M91)	30/35-15 (31358352, 742466M1)	30/36-15 (31358346, 740571M1)
20 Sans anneau pare-flamme Without flame ring	A4.248	30/31-58 (B3158)				30/35-23 (3135X034, 3637334M1)	30/36-23 (3135X033, 3637333M1)
788	A4.270	30/31-20 (B1110)	30/32-20 (B1210)	30/33-20 (55737, 3639030M1)	30/34-20 (41158121, 745952M91)	30/35-20 (31358506, 3639874M1)	

Les références des pièces sont indicatives.
Nos pièces ne sont pas d'origine

Part numbers are quoted for reference purposes only.
Our parts and accessories are not original.



"THE RELIABLE SERVICE"



PISTONS, JEUX DE SEGMENTS & CHEMISES
PISTONS, RING SETS & LINERS

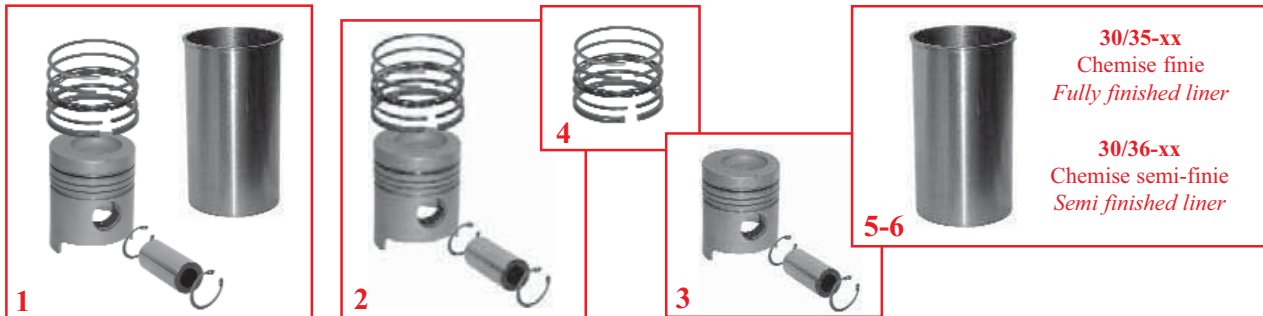

	1	2	3	4	5	6	
Tracteurs Tractors	Moteur Engine	Jeu Kit set	Piston & segm. Piston & rings	Piston & Axe Piston & pin	Jeu segments Ring set	Chemise finie Finished liner	Chemise semi-finie Semi-finished liner
6 Moissonneuses-batteuses moteurs 6 cylindres / 6 cylinder engines combines							
500, 507, 510, 515, 520, 525	A6.354	30/31-39S (U5MK0040, 3640483M91)	30/32-22 (68509, 3641196M91)	30/33-18 (86740, 738871M91)	30/34-12 (41158041, 745760M91)	30/35-14 (31358394, 744948M1)	30/36-18 (31358324, 734644M1)
24 530, 535, 800, 805	A6.354.4	30/31-70 (U5MK0127, 3638885M91)					
27 530S, 810, 815	A6.354.4	30/31-77 (B3177)	30/32-77 (B3277)	30/33-77 (U5LP0021, 748266M91)	30/34-75 (41158017, 745738M91)		
750, 760	AT6.354.1	30/31-23 (B1123)	30/32-23 (B1223)	30/33-23 (86726, 738368M91)	30/34-23 (41158031, 745751M91)		
29, 29XP, 31 560, 565, 660, 665, 750, 760, 820, 825, 830, 835, 840, 845, 850, 855, 860	AT6.354.4	30/31-78 (U5MK0071, 3637766M91)	30/32-78 (U5PR0011, 3641413M91)	30/33-78 (68803, 745379M91)	30/34-78 (41158005, 745277M91)		
31XP	AT6.354.4						
620, 625 740, 750	A6.372						30/36-13 (31358343, 737214M1)
750	A6.372.4					30/35-15 (31358352, 742466M1)	30/36-15 (31358346, 740571M1)
4 Chargeurs télescopiques / Telescopic handlers							
24	A4.236	30/31-69 (U5MK0286)	30/32-69 (68516, 3639051M1)	30/33-69 (U5LP0035, 3637516M91)	30/34-12 (41158041, 745760M91)	30/35-22 (3135X032, 3637332M1)	30/36-22 (3135X031, 3637331M1)
24T	AT4.236	30/31-74 (U5MK0169)	30/32-74 (U5PR0025, 3639514M1)	30/33-74 (U5LP0022, 3637360M91)	30/34-74 (4181A022, 3638721M91)		
8925, 8926, 8937, 8939	1004.4 (Blue)	30/31-109 (U5MK0142, 3637661M91)	30/32-109 (U5PR0016, 3637662M91)	30/33-109 (U5LL0015, 3638989M91)	30/34-110 (4181A019, 3637033M91)	30/35-108 (3135X042, 748216M1)	30/36-108 (3135X041, 748215M1)
8925, 8926, 8937, 8939	1004.42 (Green)		30/32-182 (B32182)	30/33-182 (U5LP0058, 4222949M91)	30/34-182 (4181A045, 4222950M91)		
8925T, 8926T, 8937T, 8939T	1004.4T (Blue)	30/31-108 (U5MK0275, 3640333M91)	30/32-108 (U5PR0040, 3640334M91)	30/33-108 (U5LL0014, 3640593M91)	30/34-108 (4181A026, 3641316M91)	30/35-108 (3135X042, 748216M1)	30/36-108 (3135X041, 748215M1)
8925T, 8926T, 8937T, 8939T	1004.40T (Green)	30/31-173 (B31173)	30/32-173 (U5PR0054)	30/33-173 (U5LP0057, 4222134M91)	30/34-173 (4181A033, 4222136M91)	30/35-173 (3135X062, 4222128M1)	30/36-173 (3135X063, 4222129M1)

Les références des pièces sont indicatives.
Nos pièces ne sont pas d'origine

Part numbers are quoted for reference purposes only.
Our parts and accessories are not original.



PISTONS, JEUX DE SEGMENTS & CHEMISES
PISTONS, RING SETS & LINERS

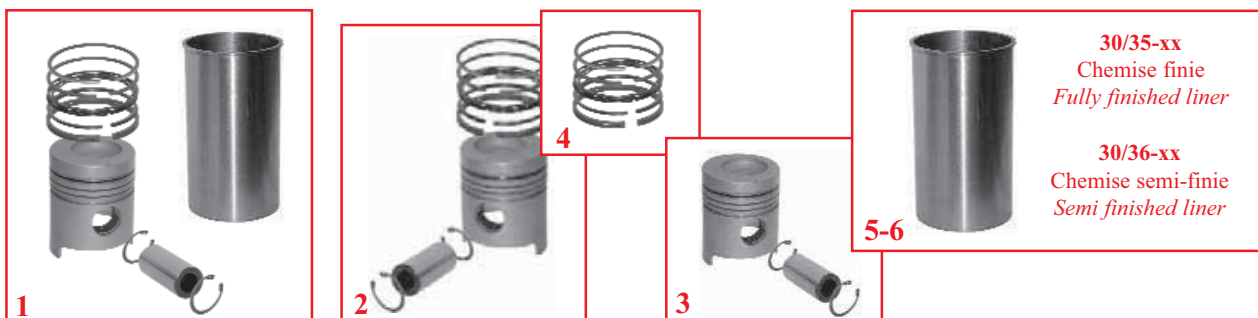

		1	2	3	4	5	6
Tracteurs Tractors	Moteur Engine	Jeu Kit set	Piston & segm. Piston & rings	Piston & Axe Piston & pin	Jeu segments Ring set	Chemise finie Finished liner	Chemise semi-finie Semi-finished liner
Tracteurs industriels moteurs 3 cylindres / 3 cylinder engine industrial tractors							
203, 205 Chemise chrome Chrome liner	A3.152	30/31-4 (U5MK0064, 3639471M1)	30/32-4 (68503, 3640441M91)	30/33-4 (A) (81512, 734460M91)	30/34-4 (41158058, 745819M91)	30/35-4 (31358308, 732638M1)	
203, 205 Chemise acier Cast iron liner	A3.152	30/31-5 (U5MK0033, 3640482M91)	30/32-5 (68502, 3639047M1)		30/34-7 (41158057, 745818M91)		
20, 40	AG3.152	30/31-11 (B3111)	30/32-11 (B3211)	30/33-11 (86723, 738287M91)	30/34-11 (41158012, 745815M91)		
20, 20B, 20F, 30H 30E (CE31116, CE31182, CE31183) 40 (CE20801, CE31084) 203, 205, 2135, 2203, 2205	AD3.152	30/31-7 (U5MK0034, 3637428M91)	30/32-7 (68504, 3639048M1)	30/33-7 (68332, 743824M91)	30/34-7 (41158057, 745818M91)	30/35-7 (31358345, 739043M1)	30/36-7 (31358323, 734179M1)
20C, 20D, 20E, 30B 30E (CE31144, CE31184) 40 (CE22438)	AD3.152	30/31-8 (U5MK0117, 3638883M91)	30/32-8 (U5PR0002)	30/33-8 (89214, 742621M91)	30/34-8 (41158065, 745826M91)		
40E	AT3.152.4	30/31-140 (B31140)	30/32-72 (B3272)	30/33-72 (U5LL0044, 4224456M91)	30/34-71 (41158144, 3637658M91) 30/34-72 (4181A017, 3638235M91)		
Tracteurs industriels moteurs 4 cylindres / 4 cylinder engine industrial tractors							
702	23C Diesel	30/31-2 (830972M92)	30/32-2 (B1199)	30/33-2 (1884101M91)	30/34-2 (894900M91)	30/35-2 (1884940M1)	
356 Chemise chrome / Chrome liner	A4.203	30/31-4 (U5MK0064, 3639471M1)	30/32-4 (68503, 3640441M91)	30/33-4 (81512, 734460M91)	30/34-4 (41158058, 745819M91)	30/35-4 (31358308, 732638M1)	
356 Chemise acier Cast iron liner	A4.203	30/31-5 (U5MK0033, 3640482M91)	30/32-5 (68502, 3639047M1)		30/34-7 (41158057, 745818M91)	30/35-7 (31358345, 739043M1)	30/36-7 (31358323, 734179M1)
356 Chemise chrome Chrome liner	AD4.203	30/31-6 (59582)	30/32-6 (82137)	30/33-7 (68332, 743824M91)	30/34-4 (41158058, 745819M91)	30/35-4 (31358308, 732638M1)	
30, 40B, 50, 302, 304, 356, 3165, 3303, 3305	AD4.203	30/31-7 (U5MK0034, 3637428M91)	30/32-7 (68504, 3639048M1)		30/34-7 (41158057, 745818M91)	30/35-7 (31358345, 739043M1)	30/36-7 (31358323, 734179M1)
50, 50B, 3303, 3305 (Bague arr. 2 pcs / Rope seal) 3 segments / 3 ring piston	A4.212	30/31-10 (B1102)	30/32-10 (68515)	30/33-10 (89206, 740082M91)	30/34-10 (41158045, 745764M91)	30/35-14 (31358394, 744948M1)	30/36-14 (31358393, 744131M1)
50, 50B, 3303, 3305 (Bague arr. 1 pc / Lip seal) 4 segments / 4 ring piston	A4.212	30/31-9 (U5MK0066, 3637432M91)	30/32-9 (68514, 1896435M91)	30/33-9 (86721, 738249M91)	30/34-9 (41158044, 745763M91)		

(A) Piston avec hauteur à rectifier disponible 30/33-5 équivalent à 68306, 743121M91.

Untopped piston available 30/33-5 equivalent to 68306, 743121M91.

(H) 30/34-71 est nécessaire avec le piston U5LP0017, 3637513M91 monté sur : / 30/34-71 is required for piston U5LP0017, 3637513M91 that fitted :

164T, 253 (UK) (CN31219), 263T (Italy), 264T, 355 & 360 (CN31187).

Piston U5LP0017, 3637513M91 est remplacé par / is replaced by 30/33-72 + 30/34-72

Les références des pièces sont indicatives.

Nos pièces ne sont pas d'origine

Part numbers are quoted for reference purposes only.

Our parts and accessories are not original.



PISTONS, JEUX DE SEGMENTS & CHEMISES
PISTONS, RING SETS & LINERS

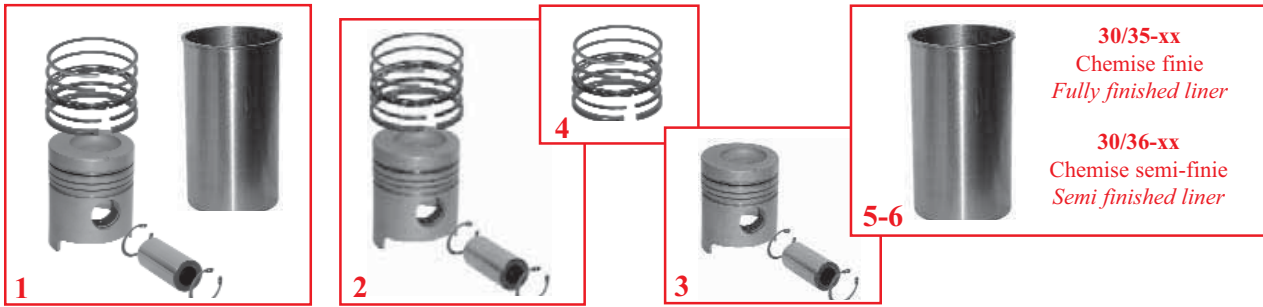

		1	2	3	4	5	6
Tracteurs Tractors	Moteur Engine	Jeu Kit set	Piston & segm. Piston & rings	Piston & Axe Piston & pin	Jeu segments Ring set	Chemise finie Finished liner	Chemise semi-finie Semi-finished liner
Tracteurs industriels moteurs 4 cylindres / 4 cylinder engine industrial tractors							
30D, 50, 50B, 50B MKII, 50C, 50D, 50E, 50H, 60 <i>Premiers blocs alésage 103.19mm Early blocks 103.19mm bore Ø</i>	A4.236	30/31-14 (U5MK0171, 363888M91)				30/35-14 (31358394, 744948M1)	30/36-14 (31358393, 744131M1)
30D, 50, 50B, 50B MKII, 50C, 50D, 50E, 50H, 60 <i>Demiers blocs alésage 104.20mm Later blocks 104.20mm bore Ø</i>	A4.236	30/31-69 (U5MK0286)	30/32-69 (68516, 3639051M1)	30/33-69 (68301, U5LP0035, 743110M91, 3637516M91)	30/34-12 (41158041, 745760M91)	30/35-22 (3135X032, 3637332M1)	30/36-22 (3135X031, 3637331M1)
50H-S, 50H-T	A4.236						
60HX, 60HX-T	AT4.236	30/31-74 (U5MK0169)	30/32-74 (U5PR0025, 3639514M1)	30/33-74 (U5LP0022, 3637360M91)	30/34-74 (4181A022, 3638721M91)		
50EX, 50HX, 60H <i>Avec anneau pare-flamme With flame ring</i>	A4.248	30/31-57 (B1126)	30/32-57 (B1226)	30/33-57 (U5LP0009, 747050M91)	30/34-57 (41158022, 747428M91)	30/35-15 (31358352, 742466M1)	30/36-15 (31358346, 740571M1)
50EX, 50HX, 60H 50HX-S, 50HX-T, 60H-S <i>Sans anneau pare-flamme Without flame ring</i>	A4.248						
70	A4.318	30/31-21 (B1111)	30/32-21 (B1211)	30/33-21 (86716, 738106M91)	30/34-21 (41158118, 745950M91)	30/35-21 (31358534, 745991M1)	30/36-21 (31358533, 745990M1)
Fermeç & Terex - Tracteurs industriels moteurs 4 cylindres / 4 cylinder engine industrial tractors							
750	1004.4 (Blue)	30/31-176 (B31176)	30/32-176 (B32176)	30/33-176 (U5LL0021, 3641806M91)	30/34-110 (E) (4181A019, 3637033M91) 30/34-176 (E) (4181A041, 4222706M91)	30/35-108 (3135X042, 748216M1)	30/36-108 (3135X041, 748215M1)
750, 750B	1004.42 (Green)		30/32-182 (B32182)	30/33-182 (U5LP0058, 4222949M91)	30/34-182 (4181A045, 4222950M91)		
760, 860, 860S, 860SE, 865, 960, 965	1004.4T (Blue)	30/31-108 (U5MK0275, 3640333M91)	30/32-108 (U5PR0040, 3640334M91)	30/33-108 (U5LL0014, 3640593M91)	30/34-90 (D) (4181A021, 3637032M91) 30/34-108 (D) (4181A026, 3641316M91)	30/35-108 (3135X042, 748216M1)	30/36-108 (3135X041, 748215M1)
760, 760B, 860, 860B, 860S, 860SE, 960, 960B, 965	1004.40T (Green)	30/31-173 (B31173)	30/32-173 (U5PR0054)	30/33-173 (U5LP0057, 4222134M91)	30/34-173 (4181A033, 4222136M91)	30/35-173 (3135X062, 4222128M1)	30/36-173 (3135X063, 4222129M1)

(D) 30/34-90 est utilisé sur les pistons U5LL0013, 3638796M91 (Premières versions). Le piston U5LL0013, 3638796M91 est remplacé par 30/33-108+30/34-108
30/34-90 is required for piston U5LL0013, 3638796M91 that fitted early versions. Piston U5LL0013, 3638796M91 is replaced by 30/33-108+30/34-108
(E) 30/34-110 est utilisé sur les pistons U5LL0017, 3641024M91 (Premières versions). Le piston U5LL0017, 3641024M91 est remplacé par 30/33-176+30/34-176
30/34-110 is required for piston U5LL0017, 3641024M91 that fitted early versions. Piston U5LL0017, 3641024M91 is replaced by 30/33-176+30/34-176

Les références des pièces sont indicatives.
Nos pièces ne sont pas d'origine

Part numbers are quoted for reference purposes only.
Our parts and accessories are not original.



JEUX SEMI-FINIS SEMI-FINISHED KIT SETS

Les jeux repris ci-dessous sont avec des chemises semi-finies et sont disponibles en plus des jeux finis repris dans la section principale. Les modèles de tracteurs et de moissonneuses-batteuses doivent être déterminés en se référant au jeu fini repris dans la section principale.
The following are kit sets with semi-finished liners that are stocked in addition to fully finished kit sets shown in the main section. Specific tractor and combine applications may be determined by referring to the fully finished kit set numbers in the main section.



Moteur Engine	Ref. Jeu fini Fully finished kit set	1 Jeu semi-fini Semi-finished kit set	2 Piston & Axe Piston & pin	3 Jeu segments Ring set	4 Chemise semi-finie Semi-finished liner
A3.144 A4.192 A6.305	30/31-3	30/31-3S (U5MK0056, 3639469M1)	30/33-3 (55274, 739845M91)	30/34-3 (41158063, 745823M91)	30/36-3 (0530002, 731595M1)
A3.152 A4.203	30/31-5	30/31-5S (U5MK0058, 3640485M91)	30/33-4 (81512, 734460M91)	30/34-7 (41158057, 745818M91)	30/36-7 (31358323, 734179M1)
AD3.152 AD4.203 <i>Piston 5 segments / 5 ring piston</i>	30/31-7	30/31-7S (U5MK0035, 3639467M1)	30/33-7 (68332, 743824M91)		
AD3.152 AD4.203 <i>Piston 4 segments / 4 ring piston</i>	30/31-8	30/31-8S (U5MK0059, 3637765M91)	30/33-8 (89214, 742621M91)	30/34-8 (41158065, 745826M91)	
A4.212	30/31-9	30/31-9S (B3109S)	30/33-9 (86721, 738249M91)	30/34-9 (41158044, 745763M91)	30/36-14 (31358393, 744131M1)
A4.236 <i>Premiers blocs alésage 103.19mm Chemise Avec anneau pare-flamme Early blocks 103.19mm bore Ø Liner with flame ring</i>	30/31-14	30/31-14S (B3114S)	30/33-69 (68301, U5LP0035, 743110M91, 3637516M91)	30/34-12 (41158041, 745760M91)	
A4.236 <i>Demiers blocs alésage 104.20mm Chemise Sans anneau pare-flamme Later blocks 104.20mm bore Ø Liner without flame ring</i>	30/31-69	30/31-69S (B3169S)			30/36-22 (3135X031, 3637331M1)
AT4.236 <i>Demiers blocs alésage 104.20mm Chemise Sans anneau pare-flamme Later blocks 104.20mm bore Ø Liner without flame ring</i>	30/31-74	30/31-74S (U5MK0170)	30/33-74 (U5LP0022, 3637360M91)	30/34-74 (4181A022, 3638721M91)	
A4.248 (⇒ U839079J) <i>Piston 4 segments / 4 ring piston Chemise Avec anneau pare-flamme Liner with flame ring</i>	30/31-15	30/31-15S (U5MK0124, 3638884M91)	30/33-13 (89207, 740821M91)	30/34-13 (4181A009, 747041M91)	30/36-15 (31358346, 740571M1)
A4.248 (U839080J ⇒) <i>Piston 3 segments / 3 ring piston</i>	30/31-57	30/31-57S (B3157S)	30/33-57 (U5LP0009, 747050M91)	30/34-57 (41158022, 747428M91)	
A4.248 <i>Chemise Sans anneau pare-flamme Liner without flame ring</i>	30/31-58	30/31-58S (B3158S)			30/36-23 (3135X033, 3637333M1)
A4.41	30/31-183	30/31-183S (B31183S)	30/33-183 (U5LL0031, 4223499M91)	30/34-183 (4115Y001, 4222053M91)	

Les références des pièces sont indicatives.
Nos pièces ne sont pas d'origine

Part numbers are quoted for reference purposes only.
Our parts and accessories are not original.



JEUX SEMI-FINIS SEMI-FINISHED KIT SETS

Les jeux repris ci-dessous sont avec des chemises semi-finies et sont disponibles en plus des jeux finis repris dans la section principale. Les modèles de tracteurs et de moissonneuses-batteuses doivent être déterminés en se référant au jeu fini repris dans la section principale.
The following are kit sets with semi-finished liners that are stocked in addition to fully finished kit sets shown in the main section. Specific tractor and combine applications may be determined by referring to the fully finished kit set numbers in the main section.



	Ref.	1	2	3	4
Moteur Engine	Jeu fini Fully finished kit set	Jeu semi-fini Semi-finished kit set	Piston & Axe Piston & pin	Jeu segments Ring set	Chemise semi-finie Semi-finished liner
A6.354 A6.354.1 A6.354.4 Piston 5 segments / 5 ring piston	30/31-70	30/31-70S (U5MK0128, 3638886M91)	30/33-18 (86740, 738871M91)	30/34-12 (41158041, 745760M91)	30/36-14 (31358393, 744131M1)
A6.354.1 A6.354.2 Piston 5 segments Al-fin Chemise droite 5 ring Al-fin piston, Parallel liner		30/31-79S (U5MK0068, 3641222M91)	30/33-24 (86745, 3637280M91)	30/34-24 (41158032, 745752M91)	30/36-18 (31358324, 734644M1)
A6.354.4 Piston 3 segments Al-fin 3 ring Al-fin piston	30/31-77	30/31-77S (U5MK0130, 3641223M91)	30/33-77 (U5LP0021, 748266M91)	30/34-75 (41158017, 745738M91)	30/36-14 (31358393, 744131M1)
AT6.354.4	30/31-78	30/31-78S (U5MK0131, 3638887M91)	30/33-78 (68803, 745379M91)	30/34-78 (41158005, 745277M91)	
1004.4 (Blue) 1006.6 (Blue)	30/31-176	30/31-176S (B31176S)	30/33-176 (U5LL0021, 3641806M91)	30/34-176 (4181A041, 4222706M91)	30/36-108 (3135X041, 748215M1)
1004.4T (Blue) 1006.6T (Blue)	30/31-108	30/31-108S (B31108S)	30/33-108 (U5LL0014, 3640593M91)	30/34-108 (4181A026, 3641316M91)	
1004.40 (Green) 1004.40T (Green) 1006.60 (Green) 1006.60T (Green)	30/31-173	30/31-173S (B31173S)	30/33-173 (U5LP0057, 4222134M91)	30/34-173 (4181A033, 4222136M91)	30/36-173 (3135X063, 4222129M1)

Les références des pièces sont indicatives.
Nos pièces ne sont pas d'origine

Part numbers are quoted for reference purposes only.
Our parts and accessories are not original.



PISTONS, SEGMENTS & CHEMISES (COTES REPARATION)
PISTONS, RING SETS & LINERS (OVERSIZE)

Les modèles de tracteurs et de moissonneuses-batteuses doivent être déterminés en se référant aux cotes standard reprises dans la section principale.
Specific tractor & combine applications may be determined by referring to the standard size numbers in the main section.

Moteur Engine	Cote standard Standard size	+ 0.25mm + 0.010"	+ 0.76mm + 0.030"	+ 1.27mm + 0.050"	+ 2.54mm + 0.100"
Pistons & segments / Pistons & rings					
A4.236 Bague arr. 2 pieces / Rope seal	30/32-12 (68506, 3640442M91)		30/32-12C (68506C)		
A6.354, A6.354.1, A6.354.4 (Premiers modèles / early models) 5 segments duaflex / 5 ring duaflex	30/32-18 (68510)		30/32-18C (68510C)		
A6.354, A6.354.1, A6.354.4 (Premiers modèles / early models) 5 segments standard / 5 ring standard	30/32-22 (68509, 3641196M91)		30/32-22C (68509C)		
Pistons / Pistons					
A4.236 Bague arr. 2 pieces / Rope seal	30/33-12 (82878, 735187M91)		30/33-12C (82878C, 3640444M91)		
A6.354, A6.354.1, A6.354.4 (Premiers modèles / early models)	30/33-18 (86740, 738871M91)		30/33-18C (86740C, 738872M91)		
Segments / Rings					
A4.236 A6.354, A6.354.2 (Premiers modèles / early models) 5 segments standard / 5 ring standard	30/34-12 (41158041, 745760M91)		30/34-12C (41158041C, 745786M91)		
A6.354, A6.354.1, A6.354.4 (Premiers modèles / early models) 5 segments duaflex / 5 ring duaflex	30/34-18 (41158029, 745750M91)		30/34-18C (41158029C, 3640234M1)		
A6.354.1, A6.354.4	30/34-24 (41158032, 745752M91)	30/34-24A (41158032A)			
Chemises semi-finies / Semi-finished liners					
A3.152, AD3.152, AG3.152, AT3.152.4, A4.203, AD4.203	30/36-7 (31358323, 734179M1)	30/36-7A (31358384, 745243M1)	30/36-7C (31358357, 3637494M1)	30/36-7E (31358323E)	30/36-7K (31358323K)

EPAISSEUR SOUS CHEMISE
CYLINDER LINER SHIMS

A3.152, AD3.152, AG3.152, AT3.154, A4.203, AD4.203

30/51-11
(33127107, 735227M1)

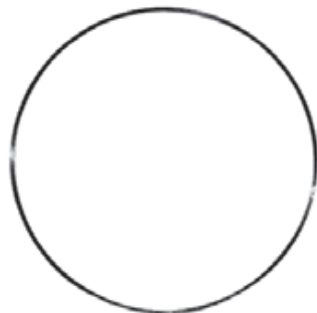

Les références des pièces sont indicatives.
Nos pièces ne sont pas d'origine

Part numbers are quoted for reference purposes only.
Our parts and accessories are not original.



PISTONS
PISTONS

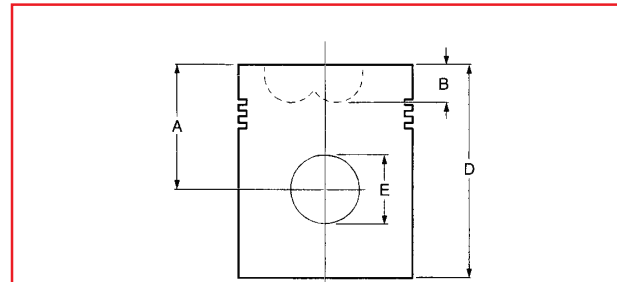
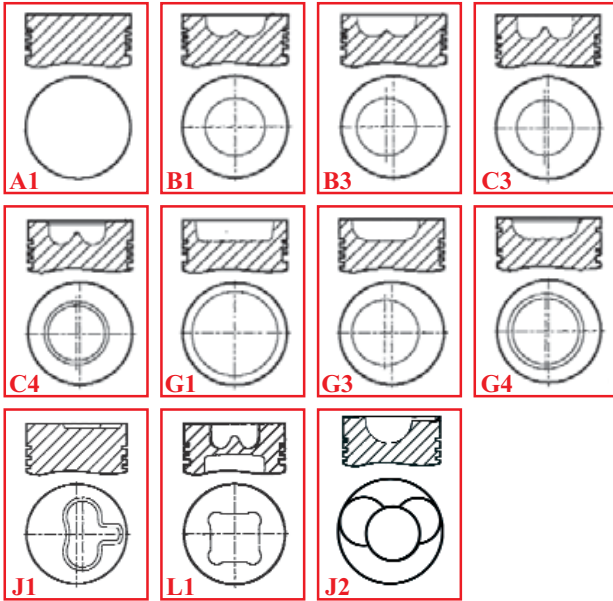

- A : Hauteur de compression (mm)
Compression height (mm)
- B : Profondeur de la chambre de combustion (mm)
Combustion bowl depth (mm)
- D : Hauteur totale (mm)
Overall length (mm)
- E : Diamètre de l'axe de piston (mm)
Gudgeon pin diameter (mm)

Réf. Ref.	Type Type	Alésage Bore Ø	Segm. Rings	Al-fin Al-fin	A (mm)	B (mm)	D (mm)	E (mm)
30/33-1	A1	80.96	5	n	60.70	-	99.00	25.40
30/33-2	J1	84.14	5	n	60.20	3.18	98.26	28.57
30/33-3	A1	88.92	5	n	57.30	-	108.10	31.75
30/33-4	A1	91.49	5	n	56.92	-	107.70	31.75
30/33-5	A1	91.49	5	n	57.33	-	108.13	31.75
30/33-7	B3	91.49	5	n	61.77	18.17	109.37	31.75
30/33-8	G3	91.49	4	n	61.63	18.70	109.25	31.75
30/33-9	G3	98.48	4	n	76.53	19.04	127.28	34.92
30/33-10	G3	98.48	3	n	76.53	19.57	116.13	34.92
30/33-11	G1	91.49	3	n	55.50	20.00	102.44	31.75
30/33-12	G3	98.48	5	n	69.92	20.15	120.65	34.92
30/33-13	G3	101.05	4	n	69.92	20.56	120.69	34.92
30/33-16	A1	79.38	5	n	45.72	-	79.86	23.81
30/33-18	C3	98.48	5	n	69.91	25.61	120.71	34.92
30/33-20	B3	107.95	5	n	73.88	22.12	124.65	36.51
30/33-21	B3	114.31	4	n	70.68	24.08	124.61	36.51
30/33-23	B1	98.48	4	n	69.65	19.08	120.42	38.10
30/33-24	C3	98.48	5	y	69.83	25.21	120.68	34.92
30/33-40	A1	85.00	5	n	51.05	-	87.58	22.22

Réf. Ref.	Type Type	Alésage Bore Ø	Segm. Rings	Al-fin Al-fin	A (mm)	B (mm)	D (mm)	E (mm)
30/33-41	A1	87.00	4	n	50.99	-	87.52	22.22
30/33-57	G3	101.05	3	n	69.90	20.65	120.70	34.92
30/33-59	B3	114.31	3	y	70.68	24.08	124.61	36.51
30/33-69	G3	98.48	5	n	70.35	20.20	120.70	34.92
30/33-72	G4	91.49	3	y	61.63	18.63	108.79	31.75
30/33-73	G3	100.00	3	n	70.09	22.44	108.25	37.51
30/33-74	G4	98.48	3	y	70.25	20.35	108.25	38.10
30/33-77	C4	98.48	3	y	69.80	23.87	120.60	34.92
30/33-78	B3	98.48	3	y	69.75	18.67	107.85	38.10
30/33-108	L1	100.00	3	y	70.02	19.48	108.06	38.00
30/33-109	L1	100.00	3	y	70.02	20.14	108.14	34.90
30/33-173	C4	100.00	3	y	70.32	21.50	108.26	36.69
30/33-174	J2	107.90	3	y	70.48	18.72	106.68	40.00
30/33-176	L1	100.00	3	y	70.02	20.14	108.14	34.90
30/33-177	C4	94.30	3	n	63.36	20.45	99.76	31.72
30/33-178	C4	94.31	3	y	63.02	21.00	99.65	31.80
30/33-179	L1	100.00	3	y	70.00	19.62	108.20	38.06
30/33-182	J2	102.38	3	n	70.32	22.22	108.38	39.68
30/33-183	G3	100.00	3	n	71.70	20.41	100.36	34.91

Les références des pièces sont indicatives.
Nos pièces ne sont pas d'origine

Part numbers are quoted for reference purposes only.
Our parts and accessories are not original.



CHEMISES LINERS

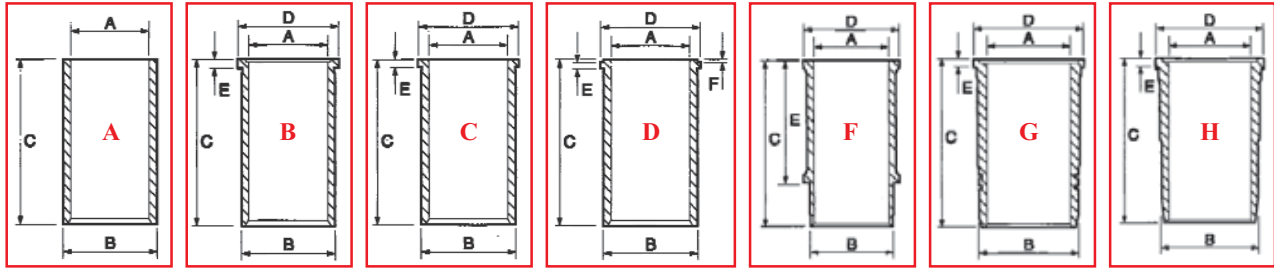

A : Alésage (mm) / Nominal bore diameter (mm)

D : Diamètre colerette (mm) / Flange diameter

B : Diamètre extérieur (mm) / Outside diameter (mm)

E : Hauteur des ailettes ou colerette (mm) / Fin height (mm)

C : Hauteur totale (mm) / Overall length (mm)

Chemises finies / Fully-finished liners

Réf. Réf.	Type Type	A (mm)	B (mm)	C (mm)	D (mm)	E (mm)	F (mm)
30/35-1	B	80.96	86.51	169.93	92.71	5.48	-
30/35-2	D	84.14	89.72	187.96	94.29	11.18	0.64
30/35-3	C	88.92	93.71	216.03	94.41	4.76	-
30/35-4	C	91.49	93.68	215.90	96.77	1.14	-
30/35-7	C	91.49	93.66	216.03	96.72	3.81	-
30/35-14	D	98.48	103.19	227.28	106.45	3.86	0.89
30/35-15	D	101.05	104.20	227.28	107.44	3.86	0.84
30/35-16	H	79.38	85.67	163.53	93.7	6.40	-
30/35-20	G	107.95	120.50	229.00	128.44	9.55	-
30/35-21	C	114.31	117.88	230.78	121.13	2.72	-
30/35-22	C	98.48	104.20	226.44	107.37	3.81	-
30/35-23	C	101.05	104.20	226.44	107.37	3.81	-
30/35-40	F	85.00	92.02	171.45	104.39	114.00	-
30/35-41	F	87.00	92.84	171.45	104.20	114.00	-
30/35-108	C	100.00	104.33	226.44	107.44	3.86	-
30/35-173	C	100.00	104.11	228.00	107.34	3.90	0.89
30/35-174	G	107.80	117.08	218.00	131.72	9.06	0.98

Chemises semi-finies / Semi-finished liners

Réf. Réf.	Type Type	A (mm)	B (mm)	C (mm)	D (mm)	E (mm)	F (mm)
30/36-3	C	88.92	93.71	216.03	94.41	4.76	-
30/36-7	C	91.49	93.71	216.03	96.72	3.81	-
30/36-13	A	101.05	103.26	223.90	-	-	-
30/36-14	D	98.48	103.24	227.28	106.23	3.86	0.89
30/36-15	D	101.05	104.25	227.28	107.44	3.86	0.76
30/36-18	A	98.48	103.26	228.98	-	-	-
30/36-21	C	114.31	117.93	230.78	121.13	2.72	-
30/36-22	C	98.48	104.20	226.44	107.37	3.81	-
30/36-23	C	101.05	104.20	226.44	107.37	3.81	-
30/36-24	A	91.49	93.76	215.90	-	-	-
30/36-108	C	100.00	104.33	226.44	107.44	3.86	-
30/36-173	C	99.08	104.11	228.00	107.34	3.91	0.98
30/36-177	A	93.55	96.70	215.00	-	-	-

Les références des pièces sont indicatives.
Nos pièces ne sont pas d'origine

Part numbers are quoted for reference purposes only.
Our parts and accessories are not original.



JEUX DE SEGMENTS
RING SETS

Réf. Réf.	Alésage Bore Ø															
30/34-1	80.96	CP1		2.00	P1		2.00	P1		2.00	DX		3.97	SS		3.97
30/34-2	84.14	CP1		2.38	P2		2.38	P2		2.38	SS		4.76	SS		4.76
30/34-3	88.92	CP1		2.38	P1		2.38	LS		3.17	DX		6.35	SS		6.35
30/34-4	91.49	P1		2.38	T1		2.38	LS		3.17	SS		6.35	SS		6.35
30/34-7	91.49	CP1		2.38	P1		2.38	LS		3.17	DX		6.35	SS		6.35
30/34-8	91.49	CP1		2.38	P2		2.38	P2		2.38	CBEH		4.76			
30/34-9	98.48	CP1		2.38	P1		2.38	P2		2.38	CBEH		6.35			
30/34-10	98.48	CP1		2.38	CP2		2.38	CBEH		6.35						
30/34-11	91.49	CP1		2.38	P2		2.38	CBEH		6.35						
30/34-12	98.48	CP1		2.38	P2		2.38	P2		2.38	CBEH		6.35	SS		6.35
30/34-12T	98.48	CR1		2.38	P2		2.38	P2		2.38	SS		6.33	SS		6.33
30/34-13	101.05	CT1		2.38	CP3		2.38	CP3		2.38	CBEH		6.35			
30/34-16	79.38	P1		1.98	P2		1.59	P2		1.59	DX		4.76	SS		4.76
30/34-18	98.48	E1		2.38	P2		2.38	P2		2.38	DX		6.35	SS		6.35
30/34-20	107.95	CP1		3.17	P1		3.17	P1		3.17	SS		6.35	SS		6.35
30/34-21	114.31	CP1		2.38	P2		2.38	P2		2.38	CBEH		6.35			
30/34-23	98.48	CP1		3.17	CP3		2.38	CP3		2.38	CBEH		6.35			
30/34-24	98.48	CP1		3.17	CP3		2.38	CP3		2.38	CBEH		6.35	SS		6.35
30/34-40	85.00	P1		2.00	P1		2.00	P1		2.00	SS		4.76	SS		3.97
30/34-41	87.00	P1		2.00	P1		2.00	SS		4.76	SS		4.76			
30/34-57	101.05	MR2		2.50	CT2		2.50	CBEH		5.00						
30/34-59	114.31	CT1		2.38	CTNI		2.38	CBEH		6.35						
30/34-71	91.49	CT1		2.38	T1		2.38	CBEH		4.76						
30/34-72	91.48	CK1		3.00	CT1		2.38	CBEH		3.50						
30/34-74	98.48	MK1		3.17	CT1		2.38	CBEH		4.76						
30/34-75	98.48	CR3		2.38	CT1		2.38	CBEH		4.76						
30/34-78	98.48	MK1		3.17	T1		2.38	CBEH		4.76						

Les références des pièces sont indicatives.
Nos pièces ne sont pas d'origine











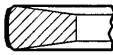

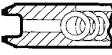
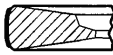
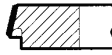
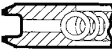







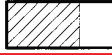



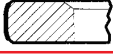



Part numbers are quoted for reference purposes only.
Our parts and accessories are not original.



"THE RELIABLE SERVICE"



JEUX DE SEGMENTS
RING SETS

Réf. Réf.	Alésage Bore Ø					
30/34-90	100.00	CK1	 3.00	T1	 2.50	CBEH  4.00
30/34-108	100.00	CK2	 3.50	TN1	 2.50	CBEH  4.00
30/34-110	100.00	CR3	 2.50	T1	 2.50	CBEH  4.00
30/34-173	100.00	CK1	 3.50	TN1	 2.50	CBEH  3.50
30/34-174	108.00	CK1	 3.00	P1	 2.50	CBEH  4.00
30/34-175	108.00	CP1	 2.50	P1	 3.00	CBEH  5.00
30/34-176	100.00	CR3	 2.50	T1	 2.50	CBEH  4.00
30/34-177	95.00	CK1	 3.00	T5	 2.00	CBEH  4.00
30/34-178	95.00	CT1	 2.50	T5	 2.00	CBEH  4.00
30/34-182	103.00	CR1	 2.50	TN1	 2.50	CBEH  3.50
30/34-183	101.05	MR2	 2.50	CT2	 2.50	CBEH  5.00

CBEH : Chromé chanfreiné avec ressort hélicoïdal / *Chrome plated bevelled edge with helical coil spring*

CK1 : Trapezoïdal bilatéral chromé / *Chrome plated keystone*

CK2 : Trapezoïdal bilatéral chromé épaulement intérieur / *Chrome plated keystone ID step*

CP1 : Rectangulaire chromé / *Chrome plated parallel faced*

CP2 : Rectangulaire chromé épaulement intérieur en haut / *Chrome plated parallel faced internally stepped top*

CP3 : Rectangulaire chromé chanfreiné intérieur en haut / *Chrome plated parallel faced internally bevelled top*

CR1 : Portée bombé chromé / *Chrome plated barrel faced*

CR3 : Portée bombée chromé chanfreiné intérieur en haut / *Chrome plated barrel faced internally bevelled top*

CT1 : Portée conique chromé / *Chrome plated taper faced*

CT2 : Portée conique chromé épaulement intérieur en haut / *Chrome plated taper faced internally stepped top*

CTN1 : Bec d'aigle portée conique chromé / *Chrome plated taper faced napier*

DX : Duaflex / *Duaflex with chrome plated segments*

E1 : Rectangulaire épaulement extérieur en haut / *Externally stepped top*

GX : Oilmaster / *Oilmaster with chrome plated segments*

LS : Segments en acier feuilleté / *Laminated steel segments*

MK1 : Trapezoïdal bilatéral molybdène / *Molybdenum coated keystone*

MR2 : Portée bombée molybdène épaulement intérieur en haut / *Molybdenum plated barrel faced internally stepped top*

P1 : Rectangulaire / *Parallel faced plain*

P2 : Rectangulaire épaulement intérieur en haut / *Parallel faced internally stepped top*

SS : Normal à fentes / *Standard slotted*

T1 : Portée conique / *Taper faced plain*

T5 : Portée conique épaulement / *Taper component*

TN1 : Bec d'aigle portée conique / *Taper faced napier*

Les références des pièces sont indicatives.
Nos pièces ne sont pas d'origine

Part numbers are quoted for reference purposes only.
Our parts and accessories are not original.



JEUX DE SOUPAPES VALVETRAIN KITS

Comprenant : Soupapes d'admission et d'échappement
Guides d'admission et d'échappement
Ressorts de soupape
Capuchons, clavettes, joints

Contents : *Inlet & exhaust valves*
Inlet & exhaust guides
Valve springs
Caps, cotters & washers



Moteur Engines	Jeu de soupapes Valve train kit
A3.144 A3.152	30/39-2 (U5VK0131, 4224156M91)
AD3.152 (⇒U584638F) Angle soupape 45° <i>Valve angle</i>	30/39-3 (U5VK0141, 4224157M91)
AD3.152 (U584639F ⇒) Angle soupape 35° <i>Valve angle</i>	30/39-4 (U5VK0111, 4224154M91)
AT3.152.4	30/39-5 (U5VK0121, 4224155M91)
A4.192 A4.203	30/39-8 (U5VK0130+U5VK0131)
AD4.203 (⇒U546167F) Angle soupape 45° <i>Valve angle</i>	30/39-9 (U5VK0140+U5VK0141)
AD4.203 (U546168F ⇒) Angle soupape 35° <i>Valve angle</i>	30/39-44 (U5VK0120+U5VK0121)
A4.212, A4.236, A4.248 (Spécification standard <i>Low rated</i>)	30/39-12 (U5VK0151, 4224158M91)
A4.212, A4.236, A4.248 (Spécification supérieure <i>High rated</i>)	30/39-15 (U5VK0161, 4224159M91)
AT4.236	30/39-13 (U5VK0171, 4224160M91)
A4.318 A4.318.2	30/39-16 (A) (B3916)
A6.354.4 AT6.354.4 A6.372.4	30/39-18 (U5VK0201, 4224165M91)
A4.41, 1004.4 (Blue), 1004.4T (Blue) Angle soupape 45° <i>Inlet valve angle</i>	30/39-40 (U5VK0181, 4224161M91)
1004.4 (Blue), 1004.4T (Blue) Angle soupape 30° <i>Inlet valve angle</i>	30/39-41 (U5VK0191, 4224163M91)
1006.6 (Blue), 1006.6T (Blue) Angle soupape 45° <i>Inlet valve angle</i>	30/39-42 (U5VK0182, 4224162M91)
1006.6 (Blue), 1006.6T (Blue) Angle soupape 30° <i>Inlet valve angle</i>	30/39-43 (U5VK0192, 422416 4M91)

(A) Le jeu ne contient pas les capuchons et joints
Kit does not include caps and washers



Les composants de nos kits ne doivent pas être mélangés à des composants plus anciens.
Ces kits sont de stock mais nous serons heureux de réaliser pour vous des kits selon vos besoins.
The components within these kits should not be mixed with older components.
These kits are stock items. We are happy to make up kits to your requirements.

Les références des pièces sont indicatives.
Nos pièces ne sont pas d'origine

Part numbers are quoted for reference purposes only.
Our parts and accessories are not original.



CULASSES & PIÈCES CONNEXES
CYLINDER HEAD PARTS

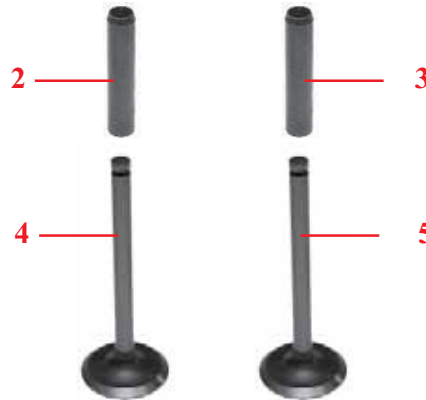
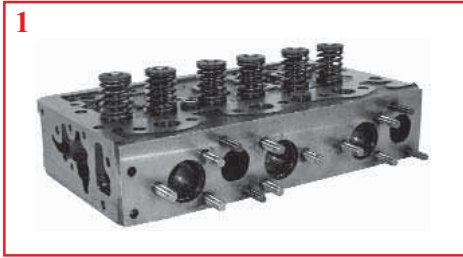

		1	2	3	4	5
Tracteurs Tractors	Moteur Engine	Culasse Cyl. Head assy.	Guide admis. Inlet guide	Guide echap. Exhaust guide	Soupape admis. Inlet valve	Soupape echap. Exhaust valve
Moteurs 3 cylindres / 3 cylinder engines						
35	A3.144 A3.152	30/40-1 (ZZ80048, 3638321M91)		30/41-3 (3316A031, 4223519M1)	30/42-3 (31431261, 731151M1)	30/43-3 (0910002, 731152M1)
133, 135	A3.144					
135	AG3.152			30/41-19 (3313E734, 4223455M1)	30/42-27 (31431741, 739641M1)	30/43-27 (31431731, 739439M1)
133, 134, 135, 140, 145, 235, 240, 245 (⇒U584638F) Angle soupape 45° Valve angle	AD3.152 Culasse / Cyl. head 86550 & 68128				30/42-4 (31431281, 732811M1)	30/43-4 (31431591, 737640M1)
133, 134, 135, 140, 145, 235, 240, 245 (U584639F ⇒) Angle soupape 35° Valve angle	AD3.152 Culasse / Cyl. head 89141 ⇒ ZZ80082	30/40-3 (ZZ80082, ZZ80235, 3637389M91, 4222810M91)		30/41-3 (3316A031, 4223519M1)		30/43-5 (31431011, 3142A081, 747581M1, 3637529M1)
148, 150, 152, 154, 230, 233, 234, 244CF, 250, 253 (Italy), 254, 255, 333, 334V, 340, 342, 350, 353, 354, 356CF, 550, 2205, 3210	AD3.152 Culasse / Cyl. head ZZ80235		30/41-3 (3316A031, 4223519M1)	30/41-19 (3313E734, 4223455M1)	30/42-5 (31431681, 739060M1)	30/43-24 (31431031, 3637616M1)
164T, 263T (Italy), 264T 355, 360 (CN31187)	AT3.152.4		30/41-20 (U3316A032, 4223487M1)	30/41-3 (3316A031, 4223519M1)	30/42-24 (31431981, 745534M1)	30/43-5 (31431011, 747581M1)
253 (UK) 352, 355 (CN31256)	AT3.152.4 Culasse / Cyl. head ZZ80139			30/41-19 (3313E734, 4223455M1)		30/43-24 (31431031, 3637616M1)
253 (UK), 264TCF 352, 355 (CN31256) 360 (CN31185) 363, 364, 366CF	AT3.152.4 Culasse / Cyl. head ZZ80113			30/41-19 (3313E734, 4223455M1)	30/42-26 (31431121, 3637528M1)	30/43-5 (3142A081, 3637529M1)
2210, 3315, 4215, 4315	903.27			30/41-60 (U3316A013, 4222938M1)	30/42-60 (3142H042, 4222579M1)	30/43-60 (3142A091, 4222580M1)
263 (UK), 2220, 3325, 4220, 4320	903.27T					

Les références des pièces sont indicatives.
Nos pièces ne sont pas d'origine

Part numbers are quoted for reference purposes only.
Our parts and accessories are not original.



"THE RELIABLE SERVICE"



CULASSES & PIÈCES CONNEXES
CYLINDER HEAD PARTS

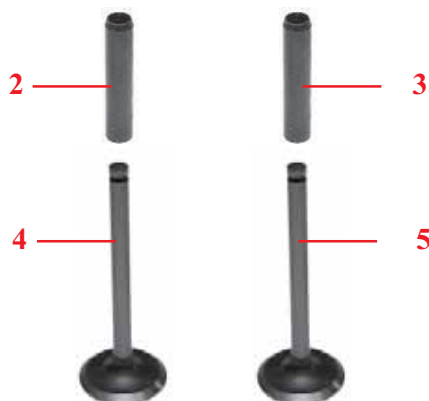
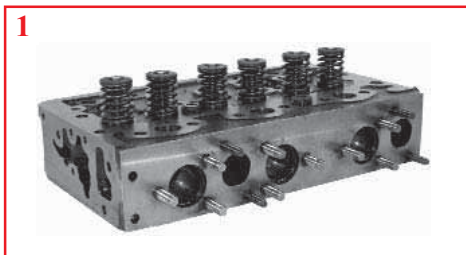

		1	2	3	4	5
Tracteurs Tractors	Moteur Engine	Culasse Cyl. Head assy.	Guide admis. Inlet guide	Guide echap. Exhaust guide	Soupape admis. Inlet valve	Soupape echap. Exhaust valve
4 Moteurs 4 cylindres / 4 cylinder engines						
TEA20 TED20 TEH20	85mm Petrol 85mm VO 85mm LO		30/41-1 (825259M1)		30/42-19 (101871)	30/43-19 (100652)
TEF 20	20C Diesel			30/41-10 (105138)	30/42-1 (101661)	30/43-1 (110926)
FE35, 835	23C Diesel		30/41-1 (825259M1)	30/41-2 (826162M1)	30/42-2 (1884123M1)	30/43-2 (1884124M1)
35, 135	87mm Petrol				30/42-20 (826244M1)	30/43-20 (826245M1)
25, 122	A4.99		30/41-9 (3313E735, 4223964M1)	30/41-3 (3316A031, 4223519M1)	30/42-15 (0910060, 3639238M1)	30/43-15 (0910061, 3639239M1)
25, 30, 130, 825	A4.107					
65	A4.192	30/40-4 (ZZ80089, 3637485M91)			30/42-3 (31431261, 731151M1)	30/43-3 (0910002, 731152M1)
65, 865	A4.203					
65, 155, 158, 165, 765 260, 560 (⇒ U546167F) Angle soupape 45° Valve angle	AD4.203	⇒ U527443E 30/40-5 (ZZ80033, 3637384M91)			30/42-4 (31431281, 732811M1)	30/43-4 (31431591, 737640M1)
158 MKIII 260, 560 (U546168F ⇒) Angle soupape 35° Valve angle	AD4.203		30/41-20 (U3316A032, 4223487M1)	30/41-3 (3316A031, 4223519M1)	30/42-5 (31431681, 739060M1)	30/43-5 (31431011, 747581M1)
165, 174	A4.212				(A) Spéc. std. Low rated 30/42-6 (31431641, 739027M1)	(A) Spéc. std. Low rated 30/43-6 (31431881, 741466M1)
168, 168MKIII, 174, 175, 184, 255 (USA), 265, 273, 274, 275, 275E, 283, 284, 362, 362N, 365, 367CF, 372N, 373, 374, 375, 375E, 376C, 377, 383, 384, 387, 565, 575, 675, 3050, 3220, 3225	A4.236	30/40-6 (ZZ80175, 3640877M91)	30/41-17 (A) (3343F041, 4223073M1)	30/41-18 (A) (3343J021, 4223074M1)	Spéc. sup. High rated 30/42-9 (31431315, 735820M1)	Spéc. sup. High rated 30/43-9 (3142A052, 747552M1)
178, 185, 188, 194, 285, 290, 290E, 293, 294, 382N, 390, 390E, 393, 394, 396C, 397, 590, 690, 3055, 3060, 3235	A4.248					
390T, 393TLX, 394TAQ, 396CT, 397T, 398, 698T, 1004T, 1007, 3065, 3065S, 3070	AT4.236				30/42-25 (3142H002, 746823M1)	30/43-9 (3142A052, 747552M1)

(A) Les soupapes en cotes réparation sont disponibles pour les culasses (⇒1985) montées sans guides. Voir page MF-77 pour plus de détails.
Oversize valves are available for cyl. head assy. (⇒1985) which were not fitted with valve guides. See Page MF-77 for details

Les références des pièces sont indicatives.
Nos pièces ne sont pas d'origine



"THE RELIABLE SERVICE"



Part numbers are quoted for reference purposes only.
Our parts and accessories are not original.

**CULASSES & PIÈCES CONNEXES
CYLINDER HEAD PARTS**

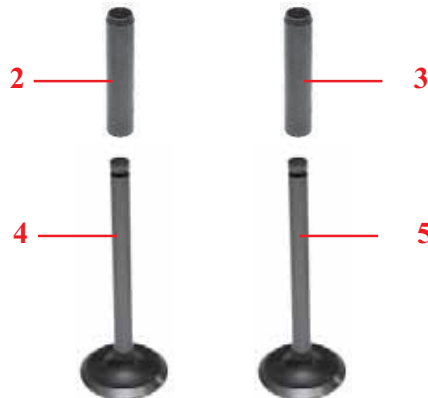

		2	3	4	5
Tracteurs Tractors	Moteur Engine	Guide admis. Inlet guide	Guide echap. Exhaust guide	Soupape admis. Inlet valve	Soupape echap. Exhaust valve
Moteurs 4 cylindres / 4 cylinder engines					
285 (USA), 592, 595, 1080, 1085	A4.318	30/41-8 (33432532, 738094M1)		30/42-16 (31431154, 738095M1)	30/43-16 (31431671, 738944M1)
285 (USA), 298, 592, 595, 698, 1004	A4.318.2				
275E, 290E, 375E, 390E, 4225, 4235, 4240, 6110, 6120	A4.41 (Blue)	30/41-17 (3343F041, 4223073M1)	30/41-18 (3343J021, 4223074M1)	30/42-38 (3142L051, 748413M1)	30/43-26 (3142A051, 748309M1)
3075, 4245, 4255, 6130, 6140, 6150	1004.4T (Blue)			30/42-39 (3142L072, 3640597M1)	
374, 3220, 3330, 4225, 4325	1004.40 (Green)	30/41-61 (3313A012, 4223987M1)	30/41-62 (3318A705, 4223581M1)	30/42-61 (3142L081, 4222149M91)	30/43-61 (3142D051, 4222147M91)
3350, 3355, 4235, 4245, 4345, 6235, 6245	1004.40T (Green)				
4265, 4365, 6265	1004.40TW (Green)			30/42-62 (3142D041, 4222894M1)	30/43-62 (3142D031, 4222896M1)
4255, 4355, 6255	1004.40T (Green)				
394, 2230, 3235, 3340, 4235 (USA), 4335	1004.42 (Green)	30/42-63 (3142H041, 4222952M1)	30/43-63 (3142D061, 4222957M1)		

Les références des pièces sont indicatives.
Nos pièces ne sont pas d'origine

Part numbers are quoted for reference purposes only.
Our parts and accessories are not original.



**CULASSES & PIÈCES CONNEXES
CYLINDER HEAD PARTS**

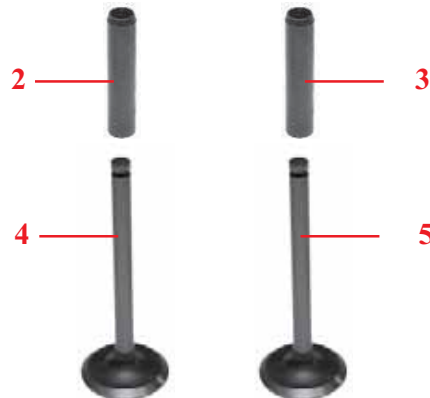

		2	3	4	5			
Tracteurs Tractors	Moteur Engine	Guide admis. Inlet guide	Guide echap. Exhaust guide	Soupape admis. Inlet valve	Soupape echap. Exhaust valve			
6 Moteurs 6 cylindres / 6 cylinder engines								
1100	A6.354			30/42-9 (31431315, 735820M1)	30/43-9 (3142A052, 747552M1)			
1014, 1104, 1200	A6.354.1				30/43-26 (3142A051, 748309M1)			
399, 699, 1014, 1024, 1114, 1250, 2620, 2625, 2640, 2645, 2675, 3080, 3090, 3610	A6.354.4				30/43-9 (3142A052, 747552M1)			
1105 1130 1135	ATC6.354.1 AT6.354 AT6.354.1							
1134, 2680, 2685, 2705, 2720, 2725, 3630, 3650	AT6.354.4							
396, 399, 3085, 3095, 3115, 4260, 4270, 6160, 6170 Angle soupape 45° Valve angle	1006.6 (Blue) Culasse / Cyl. head ZZ80225				30/41-17 (3343F041, 4223073M1)	30/41-18 (3343J021, 4223074M1)	30/42-38 (3142L051, 748413M1)	30/43-26 (3142A051, 748309M1)
3120, 3120T, 3125, 3140, 3635 (⇒ U557976X) Angle soupape 45° Valve angle	1006.6T (Blue) Culasse / Cyl. head ZZ80225						30/42-71 (3142L071, 3637042M1)	
3645, 3655, 3660 (⇒ U557976X) Angle soupape 45° Valve angle	1006.6T (Blue) Culasse / Cyl. head ZZ80226						30/42-39 (3142L072, 3640597M1)	
3120, 3120T, 3125, 3140, 3635, 3645, 3655, 3660 (U557977X ⇒) 6180, 6190, 8110, 8120, 8130 Angle soupape admission 30° Inlet valve angle 30°	1006.6T (Blue)							
4260, 4360, 6260	1006.60 (Green)				30/41-61 (3313A012, 4223987M1)	30/41-62 (3318A705, 4223581M1)	30/42-61 (3142L081, 4222149M91)	30/43-61 (3142D051, 4222147M91)
4270, 4370, 6170, 6180, 6270, 6280, 6290, 8120, 8220	1006.60T (Green)	30/42-62 (3142D041, 4222894M1)	30/43-62 (3142D031, 4222896M1)					
8210	1006.60T							

Les références des pièces sont indicatives.
Nos pièces ne sont pas d'origine

Part numbers are quoted for reference purposes only.
Our parts and accessories are not original.



"THE RELIABLE SERVICE"



**CULASSES & PIÈCES CONNEXES
CYLINDER HEAD PARTS**



Tracteurs Tractors	Moteur Engine	2 Guide admiss. Inlet guide	3 Guide echap. Exhaust guide	4 Soupape admiss. Inlet valve	5 Soupape echap. Exhaust valve
6 Moteurs 6 cylindres / 6 cylinder engines					
3680, 3690	612DS	30/41-51 (V836136051, 3637640M1)		30/42-51 (V836328735, 3637642M1)	30/43-51 (V836328734, 3637641M1)
3670, 8140, 8150	620DS	30/41-52 (V836647601)		30/42-52 (V836646356, 3638961M91)	30/43-52 (V836646357, 3638962M91)
8240	620DSRAE				
8240Xtra	620DWBAE				
3690, 8160	634DS				
8250, 8260	634DSBAE				
8250Xtra, 8260Xtra	634DWBAE				
8260	634DSBIE				
8170, 8180, 8270, 8280	645DSBIE				
8270Xtra, 8280Xtra	645DSBAE				

Les références des pièces sont indicatives.
Nos pièces ne sont pas d'origine

Part numbers are quoted for reference purposes only.
Our parts and accessories are not original.



CULASSES & PIÈCES CONNEXES
CYLINDER HEAD PARTS

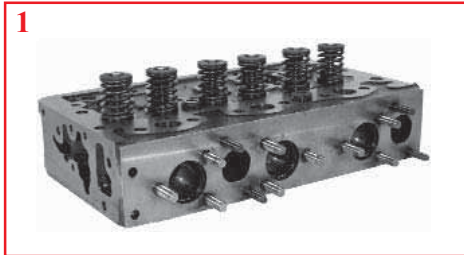

Tracteurs Tractors	Moteur Engine	1 Culasse Cyl. Head assy.	2 Guide admis. Inlet guide	3 Guide echap. Exhaust guide	4 Soupape admis. Inlet valve	5 Soupape echap. Exhaust valve		
4 Moissonneuses-batteuses moteurs 4 cylindres / 4 cylinder engines combinées								
186	A4.212	30/40-6 (ZZ80175, 3640877M91)	30/41-17 (A) (3343F041, 4223073M1)	30/41-18 (A) (3343J021, 4223074M1)	(A) Spéc. std. <i>Low rated</i> 30/42-6 (31431641, 739027M1)	(A) Spéc. std. <i>Low rated</i> 30/43-6 (31431881, 741466M1)		
8 Plot, 10 Plot, 16 Plot, 16, 99, 187, 206, 240, 307, 330	A4.236				Spéc. sup. <i>High rated</i> 30/42-9 (31431315, 735820M1)	Spéc. sup. <i>High rated</i> 30/43-9 (3142A052, 747552M1)		
20, 430, 440, 487, 506	A4.248				30/42-25 (3142H002, 746823M1)	30/43-9 (3142A052, 747552M1)		
20XP	AT4.236				30/41-8 (33432532, 738094M1)	30/42-16 (31431154, 738095M1)	30/43-16 (31431671, 738944M1)	
788	A4.270							
400, 410, 415	A4.300	6 Moissonneuses-batteuses moteurs 6 cylindres / 6 cylinder engines combinées						
500, 507, 510, 515, 520, 525	A6.354	30/41-17 (3343F041, 4223073M1)	30/41-18 (3343J021, 4223074M1)	30/42-9 (31431315, 735820M1)	30/43-9 (3142A052, 747552M1)			
24, 27, 530, 530S, 535, 800, 805, 810, 815	A6.354.4				30/43-26 (3142A051, 748309M1)			
750, 760	AT6.354.1				30/43-9 (3142A052, 747552M1)			
29, 29XP, 31, 560, 565, 660, 665, 750, 760, 820, 825, 830, 835, 840, 845, 850, 855, 860	AT6.354.4				30/43-26 (3142A051, 748309M1)			
31XP	AT6.354.4				30/43-9 (3142A052, 747552M1)			
620, 625, 740, 750	A6.372				30/43-26 (3142A051, 748309M1)			
750	A6.372.4							

(A) Les soupapes en cotes réparation sont disponibles pour les culasses (⇒1985) montées sans guides. Voir page MF-77 pour plus de détails.
Oversize valves are available for cyl. head assy. (⇒1985) which were not fitted with valve guides. See Page MF-77 for details

Les références des pièces sont indicatives.
Nos pièces ne sont pas d'origine





"THE RELIABLE SERVICE"

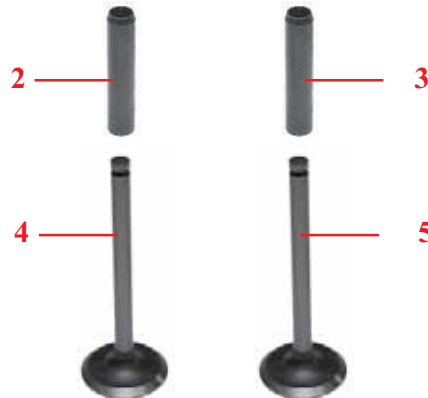
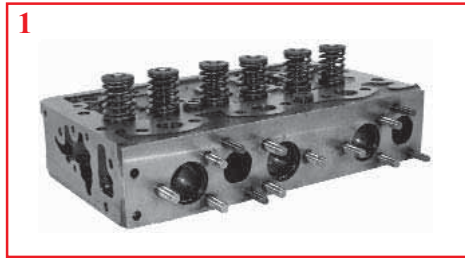

Part numbers are quoted for reference purposes only.
Our parts and accessories are not original.

CULASSES & PIÈCES CONNEXES
CYLINDER HEAD PARTS



Tracteurs Tractors	Moteur Engine	1 Culasse Cyl. Head assy.	2 Guide admiss. Inlet guide	3 Guide echap. Exhaust guide	4 Soupape admiss. Inlet valve	5 Soupape echap. Exhaust valve
 Chargeurs télescopiques / Telescopic handlers						
24	A4.236	30/40-6 (ZZ80175, 3640877M91)	30/41-17 (A) (3343F041, 4223073M1)	30/41-18 (A) (3343J021, 4223074M1)	(A) Spéc. std. <i>Low rated</i> 30/42-6 (31431641, 739027M1)	(A) Spéc. std. <i>Low rated</i> 30/43-6 (31431881, 741466M1)
24T	AT4.236				(A) Spéc. sup. <i>High rated</i> 30/42-9 (31431315, 735820M1)	(A) Spéc. sup. <i>High rated</i> 30/43-9 (3142A052, 747552M1)
8925, 8926, 8937, 8939	1004.4 (Blue)				30/42-25 (3142H002, 746823M1)	30/43-9 (3142A052, 747552M1)
8925T, 8926T, 8937T, 8939T	1004.4T (Blue)				30/42-38 (3142L051, 748413M1)	30/43-26 (3142A051, 748309M1)
8925, 8926, 8937, 8939	1004.42 (Green)				30/42-39 (3142L072, 3640597M1)	
8925T, 8926T, 8937T, 8939T	1004.40T (Green)				30/42-63 (3142H041, 4222952M1)	30/43-63 (3142D061, 4222957M1)
			30/41-61 (3313A012, 4223987M1)	30/41-62 (3318A705, 4223581M1)	30/42-62 (3142D041, 4222894M1)	30/43-62 (3142D031, 4222896M1)

(A) Les soupapes en cotes réparation sont disponibles pour les culasses (⇒1985) montées sans guides. Voir page MF-77 pour plus de détails.
Overized valves are available for cyl. head assy. (⇒1985) which were not fitted with valve guides. See Page MF-77 for details

Les références des pièces sont indicatives.
Nos pièces ne sont pas d'origine

Part numbers are quoted for reference purposes only.
Our parts and accessories are not original.



**CULASSES & PIÈCES CONNEXES
CYLINDER HEAD PARTS**

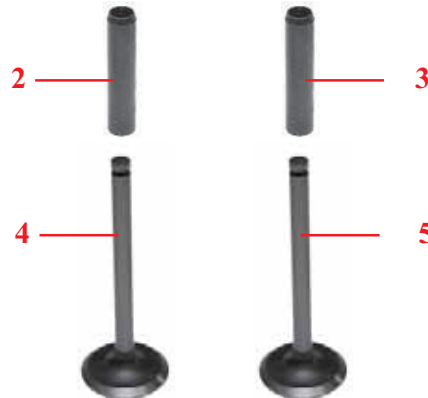
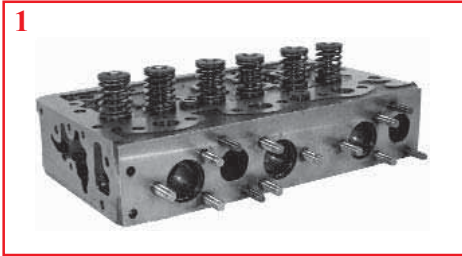

Tracteurs Tractors	Moteur Engine	1 Culasse Cyl. Head assy.	2 Guide admis. Inlet guide	3 Guide echap. Exhaust guide	4 Soupape admis. Inlet valve	5 Soupape echap. Exhaust valve
Tracteurs industriels moteurs 3 cylindres / 3 cylinder engine industrial tractors						
203, 205	A3.152	30/40-1 (ZZ80048, 3638321M91)	30/41-3 (3316A031, 4223519M1)		30/42-3 (31431261, 731151M1)	30/43-3 (0910002, 731152M1)
20, 40	AG3.152		30/41-19 (3313E734, 4223455M1)		30/42-27 (31431741, 739641M1)	30/43-27 (31431731, 739439M1)
20, 20B, 40, 203, 205, 2135, 2203, 2205 (⇒U584638F) Angle soupape 45° Valve angle	AD3.152 Culasse / Cyl. head 86550 & 68128	30/40-3 (ZZ80082, ZZ80235, 3637389M91, 4222810M91)	30/41-3 (3316A031, 4223519M1)		30/42-4 (31431281, 732811M1)	30/43-4 (31431591, 737640M1)
20, 20B, 40, 203, 205, 2135, 2203, 2205 (U584639F ⇒) Angle soupape 35° Valve angle	AD3.152 Culasse / Cyl. head 89141 ⇒ ZZ80082					30/42-5 (31431681, 739060M1)
20C, 20D, 20E, 20F, 30B, 30E, 30H	AD3.152 Culasse / Cyl. head ZZ80235		30/41-3 (3316A031, 4223519M1)	30/41-19 (3313E734, 4223455M1)		30/43-24 (31431031, 3637616M1)
40E (CN31157, CN31158)	AT3.152.4		30/41-20 (U3316A032, 4223487M1)	30/41-3 (3316A031, 4223519M1)	30/42-24 (31431981, 745534M1)	30/43-5 (31431011, 3142A081, 747581M1, 3637529M1)
40E (CN31195, CN31196)	AT3.152.4		30/41-19 (3313E734, 4223455M1)		30/42-26 (31431121, 3637528M1)	

Les références des pièces sont indicatives.
Nos pièces ne sont pas d'origine

Part numbers are quoted for reference purposes only.
Our parts and accessories are not original.



CULASSES & PIÈCES CONNEXES
CYLINDER HEAD PARTS

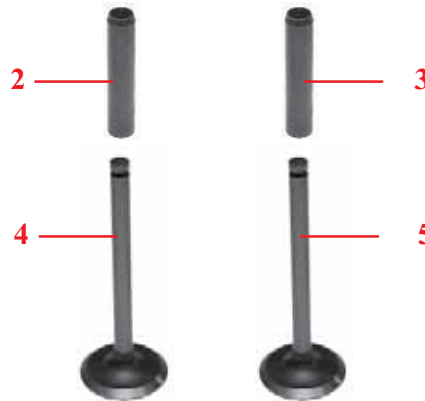
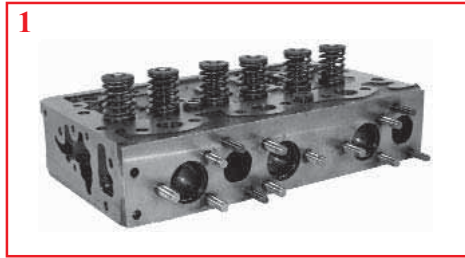

Tracteurs Tractors	Moteur Engine	1 Culasse Cyl. Head assy.	2 Guide admis. Inlet guide	3 Guide echap. Exhaust guide	4 Soupape admis. Inlet valve	5 Soupape echap. Exhaust valve
Tracteurs industriels moteurs 4 cylindres / 4 cylinder engine industrial tractors						
702	23C Diesel		30/41-1 (825259M1)	30/41-2 (826162M1)	30/42-2 (1884123M1)	30/43-2 (1884124M1)
356	A4.203	30/40-4 (ZZ80089, 3637485M91)	30/41-3 (3316A031, 4223519M1)		30/42-3 (31431261, 731151M1)	30/43-3 (0910002, 731152M1)
30, 40B, 50, 302, 304, 356, 3165, 3303, 3305	AD4.203	30/40-5 (ZZ80033, 3637384M91)			30/42-4 (31431281, 732811M1)	30/43-4 (31431591, 737640M1)
50, 50B, 3303, 3305	A4.212	30/40-6 (ZZ80175, 3640877M91)	30/41-17 (A) (3343F041, 4223073M1)	30/41-18 (A) (3343J021, 4223074M1)	(A) Spéc. std. <i>Low rated</i> 30/42-6 (31431641, 739027M1)	(A) Spéc. std. <i>Low rated</i> 30/43-6 (31431881, 741466M1)
30D, 50, 50B, 50BMKII, 50C, 50D, 50E, 50H, 50H-S, 50H-T, 60	A4.236				Spéc. sup. <i>High rated</i> 30/42-9 (31431315, 735820M1)	Spéc. sup. <i>High rated</i> 30/43-9 (3142A052, 747552M1)
50EX, 50HX, 50HX-S, 50HX-T, 60H, 60H-S	A4.248				30/42-25 (3142H002, 746823M1)	30/43-9 (3142A052, 747552M1)
60HX, 60HX-T	AT4.236					
70	A4.318		30/41-8 (33432532, 738094M1)		30/42-16 (31431154, 738095M1)	30/43-16 (31431671, 738944M1)
Fermeq & Terex - Tracteurs industriels moteurs 4 cylindres / 4 cylinder engine industrial tractors						
750	1004.4 (Blue)		30/41-17 (3343F041, 4223073M1)	30/41-18 (3343J021, 4223074M1)	30/42-38 (3142L051, 748413M1)	30/43-26 (3142A051, 748309M1)
760, 860, 860S, 860SE, 865, 960, 965 (⇒ U608300W) <i>Angle soupape 45° Valve angle</i>	1004.4T (Blue)				30/42-39 (3142L072, 3640597M1)	
760, 860, 860S, 860SE, 865, 960, 965 (U608301W ⇒) <i>Inlet valve angle 30°</i>	1004.4T (Blue)					
750, 750B	1004.42 (Green)		30/41-61 (3313A012, 4223987M1)	30/41-62 (3318A705, 4223581M1)	30/42-63 (3142H041, 4222952M1)	30/43-63 (3142D061, 4222957M1)
760, 760B, 860, 860B, 860S, 860SE, 960, 960B, 965	1004.40T (Green)				30/42-62 (3142D041, 4222894M1)	30/43-62 (3142D031, 4222896M1)

(A) Les soupapes en cotes réparation sont disponibles pour les culasses (⇒1985) montées sans guides. Voir page MF-77 pour plus de détails.
Oversize valves are available for cyl. head assy. (⇒1985) which were not fitted with valve guides. See Page MF-77 for details

Les références des pièces sont indicatives.
Nos pièces ne sont pas d'origine

Part numbers are quoted for reference purposes only.
Our parts and accessories are not original.



"THE RELIABLE SERVICE"



**CULASSES & PIÈCES CONNEXES
CYLINDER HEAD PARTS**

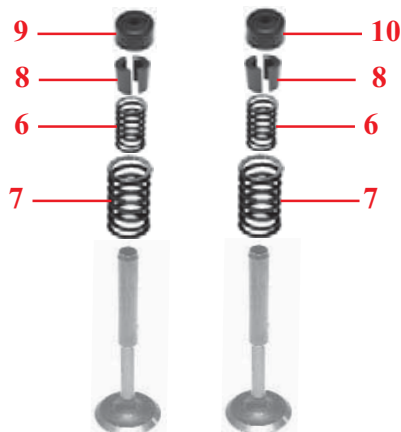

Tracteurs Tractors	Moteur Engine	6 Ressort int. Inner spring	7 Ressort ext. Outer spring	8 Clavettes Cotter	9 Joint admis. Inlet seal	10 Joint echap. Exhaust seal
Moteurs 3 cylindres / 3 cylinder engines						
35, 133, 135	A3.144		30/45-3 (0780006, 731154M1)	30/46-1 (0230001, 731155M1)	30/47-60 (2415258, 1446022M91)	
35	A3.152					
135	AG3.152	30/44-3 (0780007, 731153M1)				
133, 134, 135, 140, 145, 148, 150, 152, 154, 230, 233, 234, 235, 240, 244CF, 245, 250, 253 (Italy), 254, 255, 333, 334V, 340, 342, 350, 353, 354, 356CF, 550, 2205, 3210	AD3.152 <i>Culasse / Cyl. head</i> ⇒ ZZ80082					
	AD3.152 <i>Culasse / Cyl. head</i> ZZ80235		30/45-60 (0780012, 3637678M1)			
164T, 263T (Italy), 264T 355, 360 (CN31187)	AT3.152.4	Uniq. Admiss. Inlet only 30/44-3 (0780007, 731153M1)	30/45-3 (0780006, 731154M1)		30/47-60 (2415258, 1446022M91)	
253 (UK), 264TCF 352, 355 (CN31256) 360 (CN31185) 363, 364, 366CF	AT3.152.4					
2210, 3315, 4215, 4315	903.27		30/45-17 (3174P002, 4222584M1)	30/46-13 (3142W003, 4222586M1)	30/47-66 (2418M508, 4224300M1)	
263 (UK), 2220, 3325, 4220, 4320	903.27T					

Les références des pièces sont indicatives.
Nos pièces ne sont pas d'origine

Part numbers are quoted for reference purposes only.
Our parts and accessories are not original.



**CULASSES & PIÈCES CONNEXES
CYLINDER HEAD PARTS**

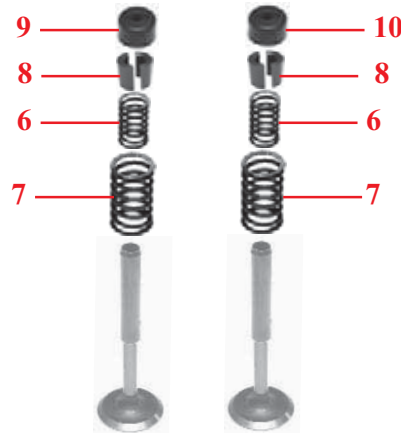

		6	7	8	9	10
Tracteurs Tractors	Moteur Engine	Ressort int. Inner spring	Ressort ext. Outer spring	Clavettes Cotter	Joint admis. Inlet seal	Joint echap. Exhaust seal
4 Moteurs 4 cylindres / 4 cylinder engines						
TEA20 TED20 TEH20	85mm Petrol 85mm VO 85mm LO		30/45-11 (825186M1)			
TEF20	20C Diesel	30/44-1 (103369)	30/45-1 (103368)			
FE35, 835	23C Diesel	30/44-2 (1884126M1)	30/45-2 (1884125M1)			
35, 135	87mm Petrol		30/45-11 (825186M1)			
25, 122	A4.99				30/47-7 (33817403, 3639965M1)	
25, 30, 130, 825	A4.107					
65	A4.192	30/44-3 (0780007, 731153M1)		30/46-1 (0230001, 731155M1)		
65, 865	A4.203					
65, 155, 158, 165, 765, 260, 560 (⇒ U546167F) Angle soupape 45° Valve angle	AD4.203		30/45-3 (0780006, 731154M1)			
158MKIII 260, 560 (U546168F ⇒) Angle soupape 35° Valve angle	AD4.203	Uniq. Admiss. Inlet only 30/44-3 (0780007, 731153M1)			30/47-60 (2415258, 1446022M91)	
165, 174	A4.212	Ø 1.00" - 25mm Lg 2.09" - 53mm 30/44-4 (31744131, 31744127, 735525M1, 747813M1)	Ø 1.41" - 36mm Lg 2.58" - 66mm 30/45-4 (31745121, 31745117, 735521M1, 747814M1)		30/47-1 (33817117, 3637041M1)	Joint Seal 30/47-1 (33817117, 3637041M1) Avec ressort With spring 30/47-1S
168, 168MKIII, 174, 175, 184, 255 (USA), 265, 273, 274, 275, 275E, 283, 284, 362, 362N, 365, 367CF, 372N, 373, 374, 375, 375E, 376C, 377, 383, 384, 387, 565, 575, 675, 3050, 3220, 3225	A4.236			30/46-2 (33173108, 736453M1)		
178, 185, 188, 194, 285, 290, 290E, 293, 294, 382N, 390, 390E, 393, 394, 396C, 397, 590, 690, 3050, 3060, 3235	A4.248	Ø 1.10" - 28mm Lg 1.72" - 44mm 30/44-67 (31744133, 740465M1)	Ø 1.48" - 38mm Lg 1.84" - 47mm 30/45-61 (31745122, 740467M1)		Avec ressort With spring 30/47-1S	O-ring 'O' Ring 30/47-67 (2415B201, 1447652M1)
390T, 393TLX, 394TAQ, 396CT, 397T, 398, 698T, 1004T, 1007, 3065, 3065S, 3070	AT4.236	30/44-4 (31744131, 735525M1)	30/45-4 (31745121, 735521M1)			

Les références des pièces sont indicatives.
Nos pièces ne sont pas d'origine

Part numbers are quoted for reference purposes only.
Our parts and accessories are not original.



**CULASSES & PIÈCES CONNEXES
CYLINDER HEAD PARTS**

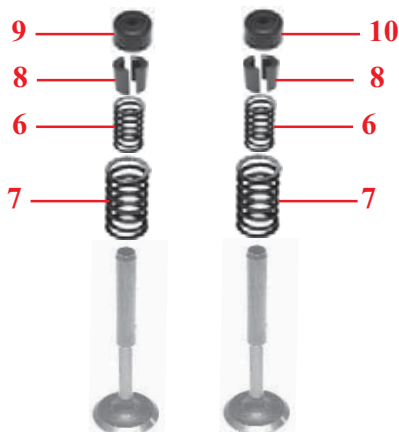

		6	7	8	9	10
Tracteurs Tractors	Moteur Engine	Ressort int. Inner spring	Ressort ext. Outer spring	Clavettes Cotter	Joint admis. Inlet seal	Joint echap. Exhaust seal
4 Moteurs 4 cylindres / 4 cylinder engines						
285 (USA), 592, 595, 1080, 1085	A4.318	30/44-4 (31744131, 735525M1)	30/45-4 (31745121, 735521M1)	30/46-2 (33173108, 736453M1)	30/47-1 (33817117, 3637041M1)	Avec ressort With spring 30/47-1S
285 (USA), 298, 592, 595, 698, 1004	A4.318.2					
275E, 290E, 375E, 390E, 4225, 4235, 4240, 6110, 6120	A4.41 (Blue)	Double / Double 30/44-67 (31744133, 740465M1)	Double / Double 30/45-61 (31745122, 740467M1)			
3075, 4245, 4255, 6130, 6140, 6150	1004.4T (Blue)	30/44-67 (31744133, 740465M1)	30/45-61 (31745122, 740467M1)	30/46-14 (3142W004, 4222141M1)	30/47-63 (2418M506, 4222333M1)	30/47-65 (2418M505, 4223442M1)
374, 3220, 3330, 4225, 4325	1004.40 (Green)		30/45-63 (3174P409, 4224316M1)			
3350, 3355, 4235, 4245, 4255, 4345, 4355, 6235, 6245, 6255	1004.40T (Green)					
4265, 4365, 6265	1004.40TW (Green)					
394, 2230, 3235, 3340, 4235 (USA), 4335	1004.42 (Green)		30/45-64 (3174P412, 4224006M1)		30/47-64 (2418M507, 4224007M1)	

Les références des pièces sont indicatives.
Nos pièces ne sont pas d'origine

Part numbers are quoted for reference purposes only.
Our parts and accessories are not original.



**CULASSES & PIÈCES CONNEXES
CYLINDER HEAD PARTS**

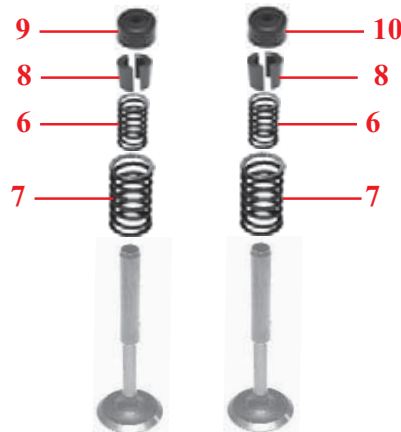

Tracteurs Tractors	Moteur Engine	6 Ressort int. Inner spring	7 Ressort ext. Outer spring	8 Clavettes Cotter	9 Joint admis. Inlet seal	10 Joint echap. Exhaust seal
Moteurs 6 cylindres / 6 cylinder engines						
1100	A6.354	Ø 1.00"- 25mm Lg 2.09"-53mm 30/44-4 (31744131, 31744127, 735525M1, 747813M1)	Ø 1.41"- 36mm Lg 2.58"-66mm 30/45-4 (31745121, 31745117, 735521M1, 747814M1)	30/46-2 (33173108, 736453M1)	30/47-2 (33817402, 733820M1)	
1014, 1104, 1200	A6.354.1					30/47-1 (33817117, 3637041M1) <i>Avec ressort / With spring</i> 30/47-1S
399, 699, 1014, 1024, 1114, 1250, 2620, 2625, 2640, 2645, 2675, 3080, 3090, 3610	A6.354.4					
1105 1130 1135	ATC6.354.1 AT6.354 AT6.354.1	Ø 1.10"- 28mm Lg 1.72"-44mm 30/44-67 (31744133, 740465M1)	Ø 1.48"- 38mm Lg 1.84"-47mm 30/45-61 (31745122, 740467M1)	30/46-2 (33173108, 736453M1)	30/47-2 (33817402, 733820M1)	
1134, 2680, 2685, 2705, 2720, 2725, 3630, 3650	AT6.354.4					
396, 399, 3085, 3095, 3115, 4260, 4270, 6160, 6170	1006.6 (Blue)		<i>Simple / Single</i> 30/45-62 (3174P405, 3637057M1)			30/47-1 (33817117, 3637041M1) <i>Avec ressort / With spring</i> 30/47-1S
3120, 3120T, 3125, 3140 3635 (⇒ U557976X)	1006.6T (Blue)	<i>Double / Double</i> 30/44-67 (31744133, 740465M1)	<i>Double / Double</i> 30/45-61 (31745122, 740467M1)			
3120, 3120T, 3125, 3140 3635 (U557977X ⇒) 3645, 3655, 3660, 6180, 6190, 8110, 8120, 8130	1006.6T (Blue)	30/44-67 (31744133, 740465M1)	30/45-61 (31745122, 740467M1)			
4260, 4360, 6260	1006.60 (Green)		30/45-63 (3174P409, 4224316M1)	30/46-14 (3142W004, 4222141M1)	30/47-63 (2418M506, 4222333M1)	30/47-65 (2418M505, 4223442M1)
4270, 4370, 6170, 6180, 6270, 6280, 6290, 8120, 8210, 8220	1006.60T (Green)					
3680, 3690	612DS	30/44-51 (V836006574, 3638929M1)	30/45-51 (V836117910, 3638934M1)	30/46-51 (V836006578, 3638931M1)		
3670, 8140, 8150	620DS	30/45-52 (V836646380, 3638964M1)		30/46-52 (V836646382, 3638966M1)		
8240	620DSRAE					
8240Xtra	620DWBAB					
3690, 8160	634DS					
8250, 8260	634DSBAE					
8250Xtra, 8260Xtra	634DWBAB					
8260	634DSBIE					
8170, 8180, 8270, 8280	645DSBIE					
8270Xtra, 8280Xtra	645DSBAE					

Les références des pièces sont indicatives.
Nos pièces ne sont pas d'origine

Part numbers are quoted for reference purposes only.
Our parts and accessories are not original.



**CULASSES & PIÈCES CONNEXES
CYLINDER HEAD PARTS**

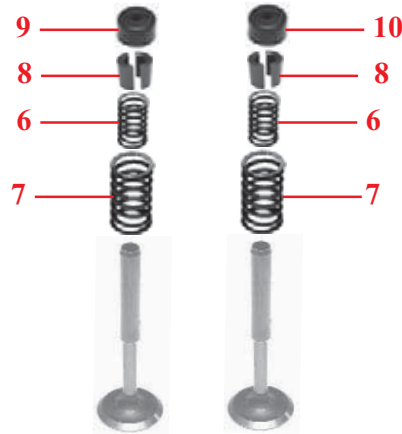

Tracteurs Tractors	Moteur Engine	6 Ressort int. Inner spring	7 Ressort ext. Outer spring	8 Clavettes Cotter	9 Joint admis. Inlet seal	10 Joint echap. Exhaust seal		
4 Moissonneuses-batteuses moteurs 4 cylindres / 4 cylinder engines combines								
186	A4.212	Ø 1.00"- 25mm Lg 2.09"-53mm 30/44-4 (31744131, 3174412F7, 735525M1, 747813M1)	Ø 1.41"- 36mm Lg 2.58"-66mm 30/45-4 (31745121, 31745117, 735521M1, 747814M1)	30/46-2 (33173108, 736453M1)	30/47-1 (33817117, 3637041M1) <i>Avec ressort With spring</i> 30/47-1S	<i>Joint Seal</i> 30/47-1 (33817117, 3637041M1) <i>Avec ressort With spring</i> 30/47-1S		
8 Plot, 10 Plot, 16 Plot, 16, 99, 187, 206, 240, 307, 330	A4.236	Ø 1.10"- 28mm Lg 1.72"-44mm 30/44-67 (31744133, 740465M1)	Ø 1.48"- 38mm Lg 1.84"-47mm 30/45-61 (31745122, 740467M1)					
20, 430, 440, 487, 506	A4.248							
20XP	AT4.236	30/44-4 (31744131, 735525M1)	30/45-4 (31745121, 735521M1)					
788	A4.270							
400, 410, 415	A4.300							
6 Moissonneuses-batteuses moteurs 6 cylindres / 6 cylinder engines combines								
500, 507, 510, 515, 520, 525	A6.354	Ø 1.00"- 25mm Lg 2.09"-53mm 30/44-4 (31744131, 31744127, 735525M1, 747813M1)	Ø 1.41"- 36mm Lg 2.58"-66mm 30/45-4 (31745121, 31745117, 735521M1, 747814M1)	30/46-2 (33173108, 736453M1)	30/47-2 (33817402, 733820M1)			
24, 27, 530, 530S, 535, 800, 805, 810, 815	A6.354.4				30/47-1 (33817117, 3637041M1) <i>Avec ressort / With spring</i> 30/47-1S			
750, 760	AT6.354.1				Ø 1.10"- 28mm Lg 1.72"-44mm 30/44-67 (31744133, 740465M1)	Ø 1.48"- 38mm Lg 1.84"-47mm 30/45-61 (31745122, 740467M1)	30/47-2 (33817402, 733820M1)	
29, 29XP, 31, 31XP, 560, 565, 660, 665, 750, 760, 820, 825, 830, 835, 840, 845, 850, 855, 860	AT6.354.4				30/47-1 (33817117, 3637041M1)			
620, 625, 740, 750	A6.372				<i>Avec ressort / With spring</i> 30/47-1S			
750	AT6.372.4							

Les références des pièces sont indicatives.
Nos pièces ne sont pas d'origine

Part numbers are quoted for reference purposes only.
Our parts and accessories are not original.



"THE RELIABLE SERVICE"



**CULASSES & PIÈCES CONNEXES
CYLINDER HEAD PARTS**

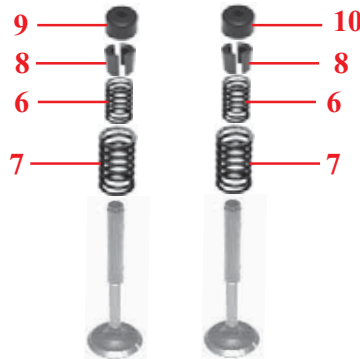

		6	7	8	9	10
Tracteurs Tractors	Moteur Engine	Ressort int. Inner spring	Ressort ext. Outer spring	Clavettes Cotter	Joint admis. Inlet seal	Joint echap. Exhaust seal
Chargeurs télescopiques / Telescopic handlers						
24	A4.236	Ø 1.00"- 25mm Lg 2.09"-53mm 30/44-4 (31744131, 31744127, 735525M1, 747813M1)	Ø 1.41"- 36mm Lg 2.58"-66mm 30/45-4 (31745121, 31745117, 735521M1, 747814M1)	30/46-2 (33173108, 736453M1)	30/47-1 (33817117, 3637041M1)	Joint Seal 30/47-1 (33817117, 3637041M1) Avec ressort With spring 30/47-1S
24T	AT4.236	Ø 1.10"- 28mm Lg 1.72"-44mm 30/44-67 (31744133, 740465M1)	Ø 1.48"- 38mm Lg 1.84"-47mm 30/45-61 (31745122, 740467M1)		Avec ressort With spring 30/47-1S	O-ring 'O' Ring 30/47-67 (2415B201, 1447652M1)
8925, 8926, 8937, 8939	1004.4 (Blue)	30/44-67 (31744133, 740465M1)	30/45-61 (31745122, 740467M1)		30/47-1 (33817117, 3637041M1)	Avec ressort / With spring 30/47-1S
8925T, 8926T, 8937T, 8939T	1004.4T (Blue)					
8925, 8926, 8937, 8939	1004.42 (Green)		30/45-64 (3174P412, 4224006M1)	30/46-14 (3142W004, 4222141M1)	30/47-64 (2418M507, 4224007M1)	30/47-65 (2418M505, 4223442M1)
8925T, 8926T, 8937T, 8939T	1004.40T (Green)		30/45-63 (3174P409, 4224316M1)		30/47-63 (2418M506, 4222333M1)	
Tracteurs industriels moteurs 3 cylindres / 3 cylinder engine industrial tractors						
203, 205	A3.152			30/46-1 (0230001, 731155M1)		
20, 40	AG3.152	30/44-3 (0780007, 731153M1)	30/45-3 (0780006, 731154M1)		30/47-60 (2415258, 1446022M91)	
20, 20B, 20C, 20D, 20E, 20F, 30B, 30E, 30H, 40, 203, 205, 2135, 2203, 2205	AD3.152 <i>Culasse / Cyl. head</i> ⇒ ZZ80082					
	AD3.152 <i>Culasse / Cyl. head</i> ZZ80235		30/45-60 (0780012, 3637678M1)			
40E (CN31157, CN 31158)	AT3.152.4	Uniq. Admiss. Inlet only 30/44-3 (0780007, 731153M1)	30/45-3 (0780006, 731154M1)		30/47-60 (2415258, 1446022M91)	
40E (CN31195, CN 31196)	AT3.152.4					

Les références des pièces sont indicatives.
Nos pièces ne sont pas d'origine

Part numbers are quoted for reference purposes only.
Our parts and accessories are not original.



"THE RELIABLE SERVICE"



**CULASSES & PIÈCES CONNEXES
CYLINDER HEAD PARTS**

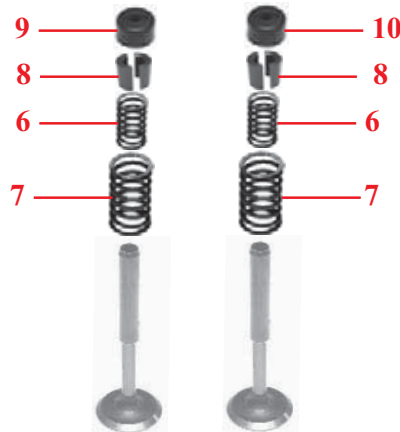

		6	7	8	9	10
Tracteurs Tractors	Moteur Engine	Ressort int. Inner spring	Ressort ext. Outer spring	Clavettes Cotter	Joint admis. Inlet seal	Joint echap. Exhaust seal
Tracteurs industriels moteurs 4 cylindres / 4 cylinder engine industrial tractors						
702	23C Diesel	30/44-2 (1884126M1)	30/45-2 (1884125M1)			
356	A4.203	30/44-3 (0780007, 731153M1)	30/45-3 (0780006, 731154M1)	30/46-1 (0230001, 731155M1)		
30, 40B, 50, 302, 304, 356, 3165, 3303, 3305	AD4.203					
50, 50B, 3303, 3305	A4.212					
30D, 50, 50B, 50BMKII, 50C, 50D, 50E, 50H, 50H-S, 50H-T, 60	A4.236	Ø 1.00"- 25mm Lg 2.09"-53mm 30/44-4 (31744131, 31744127, 735525M1, 747813M1)	Ø 1.41"- 36mm Lg 2.58"-66mm 30/45-4 (31745121, 31745117, 735521M1, 747814M1)	30/46-2 (33173108, 736453M1)	30/47-1 (33817117, 3637041M1)	Joint Seal 30/47-1 (33817117, 3637041M1) Avec ressort With spring 30/47-1S
50EX, 50HX, 50HX-S, 50HX-T, 60H, 60H-S	A4.248	Ø 1.10"- 28mm Lg 1.72"-44mm 30/44-67 (31744133, 740465M1)	Ø 1.48"- 38mm Lg 1.84"-47mm 30/45-61 (31745122, 740467M1)		Avec ressort With spring 30/47-1S	O-ring 'O' Ring 30/47-67 (2415B201, 1447652M1)
60HX, 60HX-T	AT4.236					
70	A4.318	30/44-4 (31744131, 735525M1)	30/45-4 (31745121, 735521M1)			
Fermec & Terex - Tracteurs industriels moteurs 4 cylindres / 4 cylinder engine industrial tractors						
750	1004.4 (Blue)		30/45-62 (3174P405, 3637057M1)	30/46-2 (33173108, 736453M1)	30/47-1 (33817117, 3637041M1)	
760, 860, 860S, 860SE, 865, 960, 965	1004.4T (Blue)				Avec ressort / With spring 30/47-1S	
750, 750B	1004.42 (Green)		30/45-64 (3174P412, 4224006M1)	30/46-14 (3142W004, 4222141M1)	30/47-64 (2418M507, 4224007M1)	30/47-65 (2418M505, 4223442M1)
760, 760B, 860, 860B, 860S, 860SE, 960, 960B, 965	1004.40T (Green)		30/45-63 (3174P409, 4224316M1)		30/47-63 (2418M506, 4222333M1)	

Les références des pièces sont indicatives.
Nos pièces ne sont pas d'origine

Part numbers are quoted for reference purposes only.
Our parts and accessories are not original.



"THE RELIABLE SERVICE"



CULASSES & PIÈCES CONNEXES
CYLINDER HEAD PARTS

Admission / Inlet				
Réf. Ref.	ØA (mm)	ØB (mm)	L (mm)	D (mm)
30/42-1	31.8	7.9	107.4	45°
30/42-2	38.4	7.9	110.0	45°
30/42-3	39.0	7.9	114.3	45°
30/42-4	39.0	7.9	114.3	45°
30/42-5	39.0	7.9	114.3	35°
30/42-6	44.2	9.5	123.0	45°
30/42-9	44.2	9.5	123.1	45°
30/42-15	35.7	7.9	117.0	45°
30/42-16	46.9	9.5	135.5	45°
30/42-19	28.2	7.8	108.3	45°
30/42-20	33.7	7.9	108.4	45°
30/42-24	39.0	7.9	114.5	45°
30/42-25	44.2	9.5	122.8	35°
30/42-26	38.9	7.9	114.2	35°
30/42-27	39.0	7.9	114.3	45°
30/42-38	45.0	9.5	122.9	45°
30/42-39	45.1	9.5	123.0	30°
30/42-51	44.7	8.2	148.5	45°
30/42-52	47.9	8.9	151.66	35°
30/42-60	41.8	6.9	115.3	35°
30/42-61	43.0	8.9	122.9	35°
30/42-62	42.9	8.9	122.9	45°
30/42-63	42.9	8.9	124.0	45°

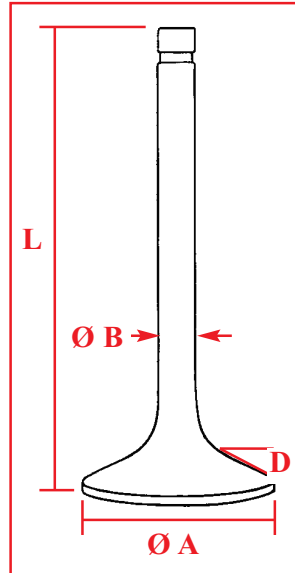

Echappement / Outlet				
Réf. Ref.	ØA (mm)	ØB (mm)	L (mm)	D (mm)
30/43-1	28.6	7.9	107.4	45°
30/43-2	31.0	9.5	110.7	45°
30/43-3	33.4	7.9	114.3	45°
30/43-4	33.4	7.9	114	45°
30/43-5	33.4	7.9	114.2	35°
30/43-6	36.6	9.5	123.3	45°
30/43-9	36.6	9.5	122.3	45°
30/43-15	30.3	7.9	117.0	45°
30/43-16	40.5	9.4	132.4	45°
30/43-19	26.5	7.9	108.2	45°
30/43-20	31.4	9.5	106.6	45°
30/43-24	33.5	7.9	114.3	45°
30/43-26	37.4	9.5	123.3	45°
30/43-27	33.5	7.9	114.5	45°
30/43-60	37.9	6.9	115.4	45°
30/43-61	41.0	8.9	122.9	35°
30/43-62	41.0	8.9	122.9	45°
30/43-63	41.9	8.9	124.0	45°
30/43-51	39.8	9.4	148.0	35°
30/43-52	40.9	8.9	152.6	45°

Les soupapes en cotes réparation sont disponibles pour les culasses (⇒1985) montées sans guides.
Oversize valves are available for cyl. head assy. (⇒1985) which were fitted without valve guides.

	Soupape admiss. Inlet valve		Soupape echap. Exhaust valve	
	Spéc. Std Low rated	Spéc. sup. High rated	Spéc. Std Low rated	Spéc. sup. High rated
0.076mm - 0.003"	30/42-6A (31431401, 736812M1)	30/42-9A (31431316, 3638919M91)	30/43-6A (31431882, 741937M1)	30/43-9A (3142A053, 747553M1)
0.38mm - 0.015"	30/42-6B (31431402, 736813M1)	30/42-9B (31431317, 3641297M1)	30/43-6B (31431883, 741938M1)	30/43-9B (3142A054, 747554M1)
0.76mm - 0.030"	30/42-6C (31431403, 736814M1)	30/42-9C (31431318, 3638920M91)	30/43-6C (31431884, 741939M1)	30/43-9C (3142A055, 747555M1)

Les références des pièces sont indicatives.
Nos pièces ne sont pas d'origine

Part numbers are quoted for reference purposes only.
Our parts and accessories are not original.



**CULBUTEURS
ROCKER SHAFTS & ARMS**

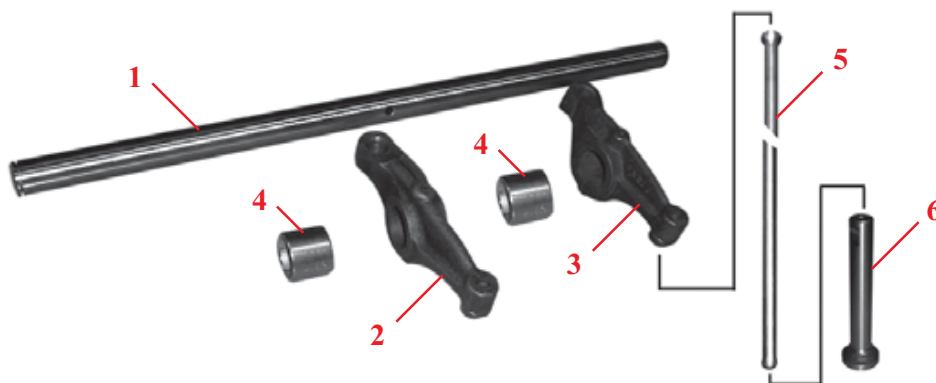

Tracteurs Tractors	Moteur Engine	1 Axe Rocker shaft	2 Culbuteur / Rocker arm		4 Bague Rocker arm bush	5 Tige Push rod	6 Poussoir Tappet
			Gauche / LH	Droit / RH			
3 Moteurs 3 cylindres / 3 cylinder engines							
35, 133, 135	A3.144	30/6051-1 (ZZ90047, 3637532M91)	30/50-4 (3737A101, 3638185M1)	30/50-5 (3737A091, 3638184M1)			30/54-2 (0860012, 731150M1)
35	A3.152						
135	AG3.152						
133, 134, 135, 140, 145, 148, 150, 152, 154, 230, 233, 234, 235, 240, 244CF, 245, 250, 253 (Italy), 254, 255, 333, 334V, 340, 342, 350, 353, 354, 356CF, 550, 2205, 3210	AD3.152						
164T, 253 (UK), 263T (Italy), 264T, 352, 355, 360, 363, 364, 366CF	AT3.152.4						
4 Moteurs 4 cylindres / 4 cylinder engines							
65	A4.192	30/6051-2 (ZZ90032, 3637395M91)	30/50-6 (4115R306, 4223076M91)	30/50-7 (4115R305, 4223075M91)	30/6052-1 (A) (2511425, 895748M1)	30/53-2 (31434307, 733817M1)	30/54-3 (3142U031, 4222069M1)
65, 865	A4.203						
65, 155, 158, 158MKIII, 165, 260, 560, 765	AD4.203						
165, 174	A4.212						
168, 168MKIII, 174, 175, 184, 255 (USA), 265, 273, 274, 275, 275E, 283, 284, 362, 362N, 365, 367CF, 372N, 373, 374, 375, 375E, 376C, 377, 383, 384, 387, 565, 575, 675, 3050, 3220, 3225	A4.236						
390T, 393TLX, 394TAQ, 396CT, 397T, 398, 698T, 1004T, 1007, 3065, 3065S, 3070	AT4.236						
178, 185, 188, 194, 285, 290, 290E, 293, 294, 382N, 390, 390E, 393, 394, 396C, 397T, 590, 690, 3055, 3060, 3235	A4.248						
275E, 290E, 375E, 390E, 4225, 4235, 4240, 6110, 6120	A4.41 (Blue)						
3075, 4245, 4255, 6130, 6140, 6150	1004.4T (Blue)						

(A) La bague 30/6052-1 est utilisée avec les culbuteurs dont la référence Perkins commence par 41151.. par ex. : 41151419, 41151421, 41151467, 41151468, 41151481, 41151482, 41151483, 41151484. Elle n'est pas nécessaire pour les culbuteurs dont la référence Perkins commence par 3737 ou 4115R.

(A) 30/6052-1 bush is used with rocker arms starting with Perkins reference 41151.. eg 41151419, 41151421, 41151467, 41151468, 41151481, 41151482, 41151483, 41151484. It is not required for rocker arms starting with Perkins reference 3737 or 4115R.

Les références des pièces sont indicatives.
Nos pièces ne sont pas d'origine

Part numbers are quoted for reference purposes only.
Our parts and accessories are not original.



**CULBUTEURS
ROCKER SHAFTS & ARMS**

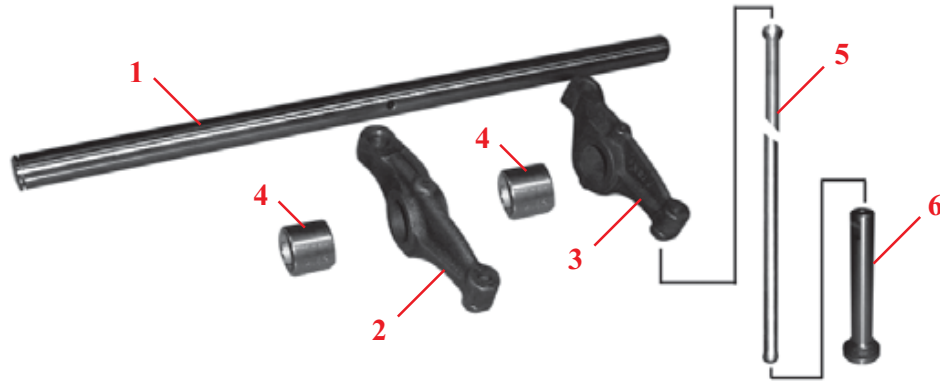

Tracteurs Tractors	Moteur Engine	1	2	3	4	5	6
		Axe Rocker shaft	Culbuteur / Rocker arm Gauche / LH Droit / RH		Bague Rocker arm bush	Tige Push rod	Poussoir Tappet
4 Moteurs 4 cylindres / 4 cylinder engines							
374, 3220, 3330, 4225, 4325	1004.40 (Green)						
3350, 3355, 4235, 4245, 4255, 4345, 4355, 6235, 6245, 6255	1004.40T (Green)					30/53-2 (31434307, 733817M1)	30/54-3 (3142U031, 4222069M1)
4265, 4365, 6265	1004.40TW (Green)						
394, 2230, 3235, 3340, 4235 (USA), 4335	1004.42 (Green)						
6 Moteurs 6 cylindres / 6 cylinder engines							
1100	A6.354						
1014, 1104, 1200	A6.354.1						
399, 699, 1014, 1024, 1114, 1250, 2620, 2625, 2640, 2645, 2675, 3080, 3090, 3610	A6.354.4						
1105 1130 1135	ATC6.354.1 AT6.354 AT6.354.1		30/50-6 (4115R306, 4223076M91)	30/50-7 (4115R305, 4223075M91)	30/6052-1 (A) (2511425, 895748M1)	30/53-2 (31434307, 733817M1)	30/54-3 (3142U031, 4222069M1)
1134, 2680, 2685, 2705, 2720, 2725, 3630, 3650	AT6.354.4						
396, 399, 3085, 3095, 3115, 4260, 4270, 6160, 6170	1006.6 (Blue)						
3120, 3120T, 3125, 3140, 3635, 3645, 3655, 3660, 6180, 6190, 8110, 8120, 8130	1006.6T (Blue)						
4260, 4360, 6260	1006.60 (Green)						
4270, 4370, 6170, 6180, 6270, 6280, 6290, 8120, 8210, 8220	1006.60T (Green)						

(A) La bague 30/6052-1 est utilisée avec les culbuteurs dont la référence Perkins commence par 41151.. par ex. : 41151419, 41151421, 41151467, 41151468, 41151481, 41151482, 41151483, 41151484. Elle n'est pas nécessaire pour les culbuteurs dont la référence Perkins commence par 3737 ou 4115R.

(A) 30/6052-1 bush is used with rocker arms starting with Perkins reference 41151.. eg 41151419, 41151421, 41151467, 41151468, 41151481, 41151482, 41151483, 41151484. It is not required for rocker arms starting with Perkins reference 3737 or 4115R.

Les références des pièces sont indicatives.
Nos pièces ne sont pas d'origine

Part numbers are quoted for reference purposes only.
Our parts and accessories are not original.



**CULBUTEURS
ROCKER SHAFTS & ARMS**

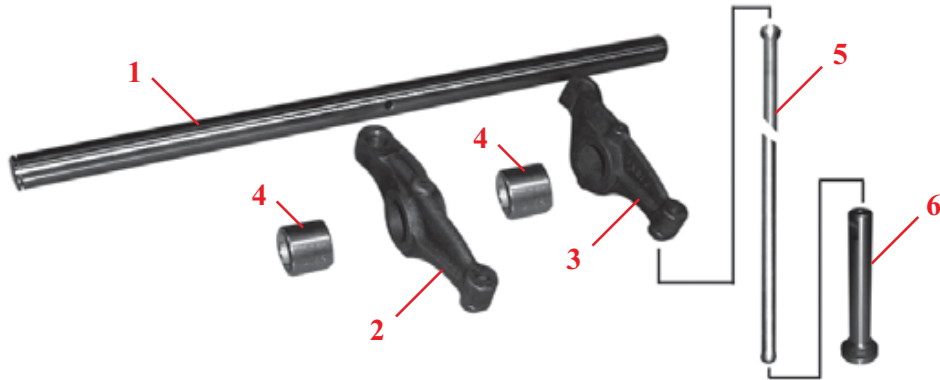

Tracteurs Tractors	Moteur Engine	Axe Rocker shaft	Culbuteur / Rocker arm		Bague Rocker arm bush	Tige Push rod	Poussoir Tappet
			Gauche / LH	Droit / RH			
4 Moissonneuses-batteuses moteurs 4 cylindres / 4 cylinder engines combinés							
186	A4.212	30/6051-2 (ZZ90032, 3637395M91)	30/50-6 (4115R306, 4223076M91)	30/50-7 (4115R305, 4223075M91)	30/6052-1 (A) (2511425, 895748M1)	30/53-2 (31434307, 733817M1)	30/54-3 (3142U031, 4222069M1)
8 Plot, 10 Plot, 16 Plot, 16, 99, 187, 206, 240, 307, 330	A4.236						
20XP	AT4.236						
20, 430, 440, 487, 506	A4.248						
6 Moissonneuses-batteuses moteurs 6 cylindres / 6 cylinder engines combinés							
500, 507, 510, 515, 520, 525	A6.354	30/50-6 (4115R306, 4223076M91)	30/50-7 (4115R305, 4223075M91)	30/6052-1 (A) (2511425, 895748M1)	30/53-2 (31434307, 733817M1)	30/54-3 (3142U031, 4222069M1)	
24, 27, 530, 530S, 535, 800, 805, 810, 815	A6.354.4						
750, 760	AT6.354.1						
29, 29XP, 31, 31XP, 560, 565, 660, 665, 750, 760, 820, 825, 830, 835, 840, 845, 850, 855, 860	AT6.354.4						
620, 625, 740, 750	A6.372						
750	A6.372.4						
4 Chargeurs télescopiques / Telescopic handlers							
24	A4.236	30/6051-2 (ZZ90032, 3637395M91)	30/50-6 (4115R306, 4223076M91)	30/50-7 (4115R305, 4223075M91)	30/6052-1 (A) (2511425, 895748M1)	30/53-2 (31434307, 733817M1)	30/54-3 (3142U031, 4222069M1)
24T	AT4.236						
8925, 8926, 8937, 8939	1004.4 (Blue)						
8925T, 8926T, 8937T, 8939T	1004.4T (Blue)						
8925, 8926, 8937, 8939	1004.42 (Green)						
8925T, 8926T, 8937T, 8939T	1004.40T (Green)						

(A) La bague 30/6052-1 est utilisée avec les culbuteurs dont la référence Perkins commence par 41151.. par ex. : 41151419, 41151421, 41151467, 41151468, 41151481, 41151482, 41151483, 41151484. Elle n'est pas nécessaire pour les culbuteurs dont la référence Perkins commence par 3737 ou 4115R.

(A) 30/6052-1 bush is used with rocker arms starting with Perkins reference 41151.. eg 41151419, 41151421, 41151467, 41151468, 41151481, 41151482, 41151483, 41151484. It is not required for rocker arms starting with Perkins reference 3737 or 4115R.

Les références des pièces sont indicatives.
Nos pièces ne sont pas d'origine

Part numbers are quoted for reference purposes only.
Our parts and accessories are not original.



"THE RELIABLE SERVICE"



**CULBUTEURS
ROCKER SHAFTS & ARMS**

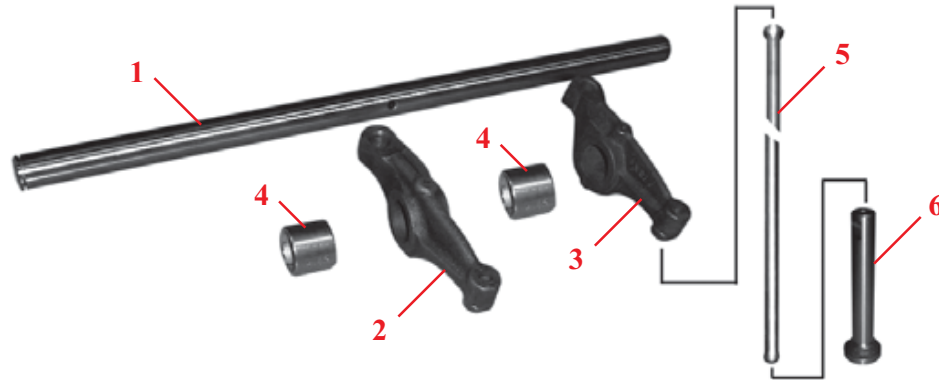

Tracteurs Tractors	Moteur Engine	Axe Rocker shaft	Culbuteur / Rocker arm		Bague Rocker arm bush	Tige Push rod	Poussoir Tappet
			Gauche / LH	Droit / RH			
Tracteurs industriels moteurs 3 cylindres / 3 cylinder engine industrial tractors							
203, 205	A3.152	30/6051-1 (ZZ90047, 3637532M91)	30/50-4 (3737A101, 3638185M1)	30/50-5 (3737A091, 3638184M1)			30/54-2 (0860012, 731150M1)
20, 40	AG3.152						
20, 20B, 20C, 20D, 20E, 20F, 30B, 30E, 30H, 40, 203, 205, 2135, 2203, 2205	AD3.152						
40E	AT3.152.4						
Tracteurs industriels moteurs 4 cylindres / 4 cylinder engine industrial tractors							
356	A4.203	30/6051-2 (ZZ90032, 3637395M91)	30/50-6 (4115R306, 4223076M91)	30/50-7 (4115R305, 4223075M91)	30/6052-1 (A) (2511425, 895748M1)	30/53-2 (31434307, 733817M1)	30/54-3 (3142U031, 4222069M1)
30, 40B, 50, 302, 304, 356, 3165, 3303, 3305	AD4.203						
50, 50B, 3303, 3305	A4.212						
30D, 50, 50B, 50B MKII, 50C, 50D, 50E, 50H, 50H-S, 50H-T, 60	A4.236						
60HX, 60HX-T	AT4.236						
50EX, 50HX, 50HX-S, 50HX-T, 60H, 60H-S	A4.248						
Fermec & Terex - Tracteurs industriels moteurs 4 cylindres / 4 cylinder engine industrial tractors							
750	1004.4 (Blue)	30/6051-2 (ZZ90032, 3637395M91)	30/50-6 (4115R306, 4223076M91)	30/50-7 (4115R305, 4223075M91)	30/6052-1 (A) (2511425, 895748M1)	30/53-2 (31434307, 733817M1)	30/54-3 (3142U031, 4222069M1)
760, 860, 860S, 860SE, 865, 960, 965	1004.4T (Blue)						
750, 750B	1004.42 (Green)						
760, 760B, 860, 860B, 860S, 860SE, 960, 960B, 965	1004.40T (Green)						

(A) La bague 30/6052-1 est utilisée avec les culbuteurs dont la référence Perkins commence par 41151.. par ex. : 41151419, 41151421, 41151467, 41151468, 41151481, 41151482, 41151483, 41151484. Elle n'est pas nécessaire pour les culbuteurs dont la référence Perkins commence par 3737 ou 4115R.

(A) 30/6052-1 bush is used with rocker arms starting with Perkins reference 41151.. eg 41151419, 41151421, 41151467, 41151468, 41151481, 41151482, 41151483, 41151484. It is not required for rocker arms starting with Perkins reference 3737 or 4115R.

Les références des pièces sont indicatives.
Nos pièces ne sont pas d'origine

Part numbers are quoted for reference purposes only.
Our parts and accessories are not original.



"THE RELIABLE SERVICE"



**JOINTS DE MOTEUR
ENGINE GASKET SETS**

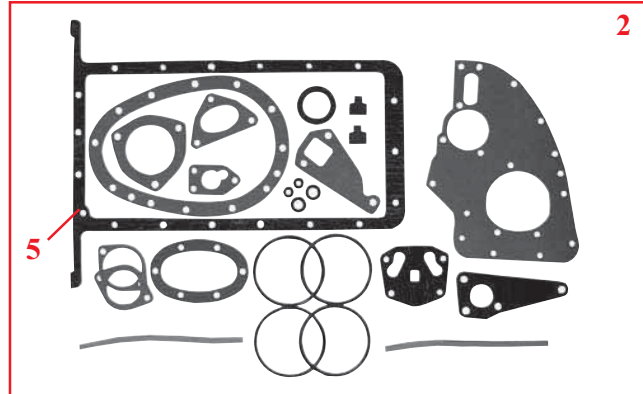
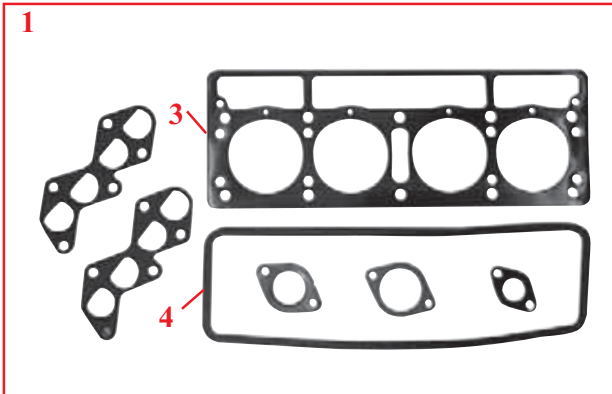

		1	2	3	4	5
Tracteurs Tractors	Moteur Engine	Pochette rodage Top gasket set	Pochette compl. Bottom gasket set	Joint de culasse Cyl. head gasket	Joint cache soupape Rocker cover gasket	Joint carter Sump gasket
3 Moteurs 3 cylindres / 3 cylinder engines						
35	A3.144 A3.152	30/71-3 (U5LT0512, 4222562M91)		30/73-3 (36812142, 4223582M1)	30/74-5 (0490491, 731273M1)	30/75-4 (D) (U5LB0501, 4223524M91)
133, 135	A3.144	30/71-107 (U5LT0511, 4223532M91)	30/72-5 (B) (U5LB1157, 4224142M91)			
135	AG3.152	30/71-9 (U5LT0537, 4223123M91)				
133, 134, 135, 140, 145, 148, 150, 152, 154, 230, 233, 234, 235, 240, 244CF, 245, 250, 253 (Italy), 254, 255, 333, 334V, 340, 342, 350, 353, 354, 356CF, 550, 3210	AD3.152	30/71-5 (A) (U5LT1138, U5LT5138, 4223922M91, 4223923M91)		30/73-4 (C) (3681E024, 3641399M1)	30/74-8 (36811115, 735057M1)	
2205	AD3.152		30/72-107 (U5LB1110, 4224032M91)			
164T, 253 (UK), 263T (Italy), 264T, 352, 355, 360, 363, 364, 366CF	AT3.152.4	30/71-5 (A) (U5LT1139, U5LT5138, 4223921M91, 4223923M91)	30/72-5 (U5LB1157, 4224142M91)			30/75-105 (D) (21826370, 21826397, 4224249M91, 4224458M1)
2210	903.27		30/72-107 (U5LB1110, 4224032M91)			
3315, 4215, 4315			30/71-81 (A) (U5LT0216, U5LT0217, 4224027M91, 4222759M91)	30/72-105 (U5LB0304, 4222760M91)	30/73-107 (3681E028, 4222588M1)	30/74-107 (3681A033, 4222648M1)
263 (UK)	903.27T		30/72-107 (U5LB1110, 4224032M91)			
2220			30/72-105 (U5LB0304, 4222760M91)			
3325, 4220, 4320						

(A) Utilisable avec les moteurs normaux et turbo / Suitable for both normally aspirated & turbo charged engines
 (B) Utilisable avec les moteurs à bague arrière une ou deux pièces / Suitable for both rope seal & lip seal blocks
 (C) Disponible aussi en version cuivre 30/73-4A (36812127, 735018M2) / Copper gasket alternative available 30/73-4A (36812127, 735018M2)
 (D) Joint de carter livré complet avec les joints en liège avant & arrière / Sump gasket is supplied complete with front & rear cork joints

Les références des pièces sont indicatives.
Nos pièces ne sont pas d'origine

Part numbers are quoted for reference purposes only.
Our parts and accessories are not original.



"THE RELIABLE SERVICE"



JOINTS DE MOTEUR ENGINE GASKET SETS

		1	2	3	4	5
Tracteurs Tractors	Moteur Engine	Pochette rodage Top gasket set	Pochette compl. Bottom gasket set	Joint de culasse Cyl. head gasket	Joint cache soupape Rocker cover gasket	Joint carter Sump gasket
4 Moteurs 4 cylindres / 4 cylinder engines						
TEA TED TEH	85mm Petrol 85mm VO 85mmLO	30/71-19 (3901525M91)	30/72-19 (894915M91)	30/73-19 (202084)	30/74-1 (829029M1)	30/75-120 (3910267M1)
TEF	20C Diesel	30/71-1 (106387)	30/72-1 (894916M91)	30/73-1 (61153)	30/74-2 (61396)	30/75-111 (3910274M1)
FE35 (⇒ SJ41889E), 835	23C Diesel	30/71-2 (1810028M91)	30/72-2 (1810027M91)	30/73-2 (1882771M1)	30/74-3 (828695M1)	
FE35 (SJ41890E ⇒)	23C Diesel				30/74-4 (826194M1)	
35, 135	87mm Petrol	30/71-20 (827560M1)	30/72-20 (894902M91)	30/73-20 (826250M1)	30/74-1 (829029M1)	30/75-120 (3910267M1)
25, 122	A4.99	30/71-30 (U5LT0523, 4222808M91)	30/72-30 (U5LB1116, 4223920M91)	30/73-30 (36812143, 4223784M1)	30/74-7 (0490724, 732117M1)	30/75-107 (D) (36815386, 4222556M91)
25, 30, 130, 825	A4.107					
65	A4.192	30/71-6 (69035, 746050M91)	30/72-6 (U5LB0502, 4223525M91)	30/73-6 (0490689, 3639160M1)	30/74-6 (0490704, 731164M1)	30/75-108 (E) (41424238, 4224063M91)
65, 865	A4.203			30/73-7 (36812141, 4222122M1)		
65, 155, 158, 165, 765 (⇒ 29C1083) <i>Bague arrière 2 pièces / Rope seal</i>	AD4.203	30/71-8 (U5LT0100, 4222920M91)	30/72-9 (U5LB1117, 4223940M91)	30/73-8 (3681E023, 3641182M1)	30/74-9 (36811112, 732821M1)	30/75-109 (E) (41424239, 21826401, 4222934M1, 4224379M1)
65, 155, 158, 165, 765 (29C1084 ⇒) <i>Bague arrière 1 pièce / Lip seal</i>	AD4.203					
158 MKIII, 260, 560	AD4.203	30/71-108 (U5LT0383, 4224307M91)				
165, 174	A4.212					
168, 174, 175, 184, 255 (USA), 265, 273, 274, 275, 283, 284, 565, 575, 675, 3050 <i>Premiers blocs alésage 103.19mm Early blocks 103.19mm bore Ø</i>	A4.236	30/71-10 (U5LT1014, 4224186M91)	30/72-10 (U5LB0145, 3640719M91)	30/73-11 (3681E021, 3638845M1)		
168, 174, 184, 255 (USA), 265, 273, 274, 275, 283, 284, 565, 575, 675, 3050 <i>Demiers blocs alésage 104.20mm Later blocks 104.20mm bore Ø</i>	A4.236					
168MKIII, 362, 362N, 365, 367CF, 372N, 373, 374, 375, 376C, 377, 383, 384, 387, 3220, 3225	A4.236	30/71-52 (U5LT1004, 4224189M91)	30/72-51 (U5LB1158, 4224369M1)	30/73-52 (3681E036, 4222500M1)	30/74-11 (3681A027, 21826363, 3638482M1, 4223924M1)	30/75-106 (3681K003, 3641273M1)
275E, 375E	A4.236					
698T, 1004T <i>Premiers blocs alésage 103.19mm Early blocks 103.19mm bore Ø</i>	AT4.236	30/71-10 (U5LT1014, 4224186M91)	30/72-10 (U5LB0145, 3640719M91)	30/73-11 (3681E021, 3638845M1)		
698T, 1004T <i>Demiers blocs alésage 104.20mm Later blocks 104.20mm bore Ø</i>	AT4.236					
390T, 393TLX, 394TAQ, 396CT, 397T, 398, 1007, 3065, 3065S, 3070	AT4.236	30/71-53 (U5LT1006, 4224246M91)		30/73-53 (3681E034, 4222124M1)		



(D) Joint de carter livré complet avec les joints en liège avant & arrière / *Sump gasket is supplied complete with front & rear cork joints*
 (E) Joint de carter livré complet avec les joints en liège arrière / *Sump gasket is supplied complete with rear cork joint*

Les références des pièces sont indicatives.
 Nos pièces ne sont pas d'origine

Part numbers are quoted for reference purposes only.
 Our parts and accessories are not original.



JOINTS DE MOTEUR ENGINE GASKET SETS

		1	2	3	4	5		
Tracteurs Tractors	Moteur Engine	Pochette rodage Top gasket set	Pochette compl. Bottom gasket set	Joint de culasse Cyl. head gasket	Joint cache soupape Rocker cover gasket	Joint carter Sump gasket		
4 Moteurs 4 cylindres / 4 cylinder engines								
178, 185, 188	A4.248	30/71-10 (U5LT1014, 4224186M91)	30/72-10 (U5LB0145, 3640719M91)	30/73-11 (3681E021, 3638845M1)	30/74-11 (3681A027, 21826363, 3638482M1, 4223924M1)	30/75-106 (3681K003, 3641273M1)		
194, 285, 290, 293, 294, 590, 690 <i>Avec anneau pare-flamme</i> <i>With flame ring</i>	A4.248							
194, 290, 293, 294, 690 <i>Sans anneau pare-flamme</i> <i>Without flame ring</i>	A4.248	30/71-52 (U5LT1004, 4224189M91)	30/72-51 (U5LB1158, 4224369M1)	(⇒ 04/03/95) 30/73-52 (3681E036, 4222500M1)				
290E, 390E	A4.248		30/72-10 (U5LB0145, 3640719M91)	(05/03/95 ⇒) 30/73-53 (3681E034, 4222124M1)				
382N, 390, 393, 394, 396C, 397, 3055, 3060, 3235	A4.248							
285 (USA), 592, 595, 1080, 1085	A4.318	30/71-31 (U5LT0520, 4223502M91)	30/72-31 (U5LB0221, 4223129M91)	30/73-31 (36812348, 745730M1)	30/74-13 (3681A008, 746036M1)	30/75-121 (21826314, 4223002M1)		
285 (USA), 298, 592, 595, 698, 1004	A4.318.2							
275E, 290E, 375E, 390E	A4.41 (Blue)	30/71-90 (F) (U5LT0215, U5LT0314, U5LT1178, U5LT1196, 4223130M91, 4223573M91, 4224621M91, 4224623M91)	30/72-113 (U5LB1160, 4224457M91)	30/73-90 (3681E037, 4224501M1)	<i>Liège / Cork</i>  30/74-90 (3681A021, 3640094M1)	30/75-106 (3681K003, 3681K005, 3641273M1, 3640406M1)		
4225 (LM31290) 4225HV (LM31324, LM31325) 4240	A4.41 (Blue)		30/72-10 (U5LB0145, 3640719M91)					
4225 (LM31320)	A4.41 (Blue)							
4225 (LM31378, LM31379) 4225HV (LM31380, LM31381) 4235, 4235HV	A4.41 (Blue)				<i>Plastique / Plastic</i>  30/74-105 (3681A032, 3641891M1)			
6110, 6120	A4.41		30/72-113 (F) (U5LB0146, U5LB1160, 3641075M91, 4224457M91)					
3075, 6130, 6140, 6150	1004.4T							
4245, 4255	1004.4T (Blue)							
374, 3220, 3330	1004.40 (Green)		30/71-82 (F) (U5LT0327, U5LT1202, 4224346M91, 4224635M91)					30/74-108 (3681A049, 4224452M91)
4225, 4325	1004.40 (Green)		30/72-114 (U5LB1319, 4224699M91)					

(F) Jeu compréhensif couvrant toutes les applications reprises / *Comprehensive set fitting all mentioned applications*

Les références des pièces sont indicatives.
Nos pièces ne sont pas d'origine



"THE RELIABLE SERVICE"





Part numbers are quoted for reference purposes only.
Our parts and accessories are not original.

MF-84

Ed.1 (07/04)

JOINTS DE MOTEUR ENGINE GASKET SETS



		1	2	3	4	5
Tracteurs Tractors	Moteur Engine	Pochette roilage Top gasket set	Pochette compl. Bottom gasket set	Joint de culasse Cyl. head gasket	Joint cache soupape Rocker cover gasket	Joint carter Sump gasket
4  Moteurs 4 cylindres / 4 cylinder engines						
3350, 3355	1004.40T (Green)					
4235, 4245, 4255, 4345, 4355, 6235, 6245, 6255	1004.40T (Green)	30/71-82 (U5LT1202, 4224635M91)	30/72-114 (U5LB1319, 4224699M91)	30/73-90 (3681E037, 4224501M1)	30/74-108 (3681A049, 4224452M91)	30/75-106 (3681K003, 3641273M1)
4265, 4365, 6265	1004.40TW					
394, 2230, 3235, 3340	1004.42 (Green)	30/71-83 (U5LT0317, 4223451M91)	30/72-113 (U5LB1160, 4224457M91)	30/73-83 (3681E042, 4223146M1)		
4235 (USA), 4335	1004.42 (Green)		30/72-114 (U5LB1319, 4224699M91)			
6  Moteurs 6 cylindres / 6 cylinder engines						
1100	A6.354	30/71-12 (U5LT1181, 4224167M91)	30/72-12 (U5LB1224, 4224120M91)	30/73-12 (36812546, 740377M1)	30/74-15 (36811412, 733834M1)	
1014, 1104	A6.354.1			30/73-35 (36812547, 740376M1)		
1200	A6.354.1	30/71-35 (U5LT1186, 4224152M91)			30/74-17 (36811451, 4222942M1)	
399, 699, 1014, 1024, 1114 2620, 2640 (S271213 ⇒) 2625, 2645, 2675, 3080, 3090, 3610	A6.354.4	30/71-59 (U5LT1190, 4224053M91)		30/73-56 (3681H202, 3638305M1)	30/74-32 (21826362, 4223925M1)	30/75-110 (U5MK0398, 36816733, 4224291M1, 4224116M1)
1250 2620, 2640 (⇒ S271212)	A6.354.4		30/72-57 (U5LB1225, 4224049M91)			
Moteurs turbo standard Standard turbo applications	AT6.354	30/71-34 (U5LT0025, 3639445M91)		30/73-12 (36812546, 740377M1)	30/74-15 (36811412, 733834M1)	
1105 1130 1135	ATC6.354.1 AT6.354 AT6.354.1	30/71-35 (U5LT1186, 4224152M91)	30/72-12 (U5LB1224, 4224120M91)	30/73-35 (36812547, 740376M1)	30/74-17 (36811451, 4222942M1)	
1134, 2680 (S271213 ⇒) 2705, 3630, 2685, 2720, 2725, 3650	AT6.354.4	30/71-59 (U5LT1190, 4224053M91)		30/73-56 (3681H202, 3638305M1)	30/74-32 (21826362, 4223925M1)	
2680 (⇒ S271212)	AT6.354.4		30/72-57 (U5LB1225, 4224049M91)			

Les références des pièces sont indicatives.
Nos pièces ne sont pas d'origine

Part numbers are quoted for reference purposes only.
Our parts and accessories are not original.



JOINTS DE MOTEUR ENGINE GASKET SETS

		1	2	3	4	5
Tracteurs Tractors	Moteur Engine	Pochette rodage Top gasket set	Pochette compl. Bottom gasket set	Joint de culasse Cyl. head gasket	Joint cache soupape Rocker cover gasket	Joint carter Sump gasket
6  Moteurs 6 cylindres / 6 cylinder engines						
396, 399	1006.6	30/71-91 (U5LT0179, 3638697M91)			Type A 	
3085, 3095, 3115, 6160, 6170	1006.6 (Blue)				30/74-91 (3681C001, 748329M1)	
3120, 3120T, 3125, 3140, 3635, 3645, 3655, 3660, 6180, 6190, 8110, 8120, 8130	1006.6T (Blue)	30/71-109 (U5LT0309, 4223114M91)		30/72-91 (F) (U5LB1167, U5LB1168, 4224613M91, 4224611M91)	Type B 	30/75-113 (3681M005, 3638562M1)
4260, 4270	1006.6 (Blue)				30/74-109 (3681C003, 3641821M1)	
4260, 4360	1006.60 (Green)	30/71-115 (F) (U5LT0300, U5LT0301, U5LT1300, U5LT1309, 4222468M91, 4223732M91, 4224667M91, 4224668M91)		30/73-91 (3681H208, 4222354M1)		
4270, 4370, 6170, 6180, 8120	1006.60T (Green)					
6260	1006.60			30/72-106 (F) (U5LB0308, U5LB1331, 4224476M91, 4224674M91)		
6270, 6280, 6290 8210, 8220	1006.60T					

(F) Jeu complet couvrant toutes les applications reprises / *Comprehensive set fitting all mentioned applications*

Les références des pièces sont indicatives.
Nos pièces ne sont pas d'origine

Part numbers are quoted for reference purposes only.
Our parts and accessories are not original.

MF-86

"THE RELIABLE SERVICE"

Ed.1 (07/04)

**JOINTS DE MOTEUR
ENGINE GASKET SETS**

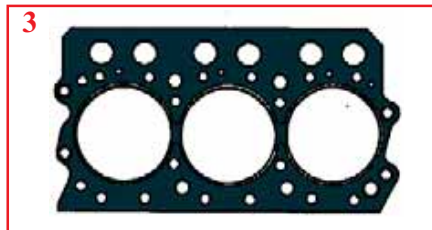

		3	4	5
Tracteurs Tractors	Moteur Engine	Joint de culasse Cyl. head gasket	Joint cache soupape Rocker cover gasket	Joint carter Sump gasket
6 Moteurs 6 cylindres / 6 cylinder engines				
3680, 3690	612DS	30/73-122 (V836122443, 3637639M1)	30/74-122 (V836322898, 3637643M1)	30/75-122 (V836322183, 3638939M1)
3670, 8140, 8150	620DS	30/73-123 (V836664155, 3638960M1)	30/74-123 (V836646360, 3638963M1)	
8240	620DSRAE			
8240Xtra	620DWBAE			
3690, 8160	634DS			
8250, 8260	634DSBAE			
8260	634DSBIE			
8250Xtra, 8260Xtra	634DWBAE			
8170, 8180, 8270, 8280	645DSBIE			
8270Xtra, 8280Xtra	645DSBAE			

Les références des pièces sont indicatives.
Nos pièces ne sont pas d'origine

Part numbers are quoted for reference purposes only.
Our parts and accessories are not original.



**JOINTS DE MOTEUR
ENGINE GASKET SETS**

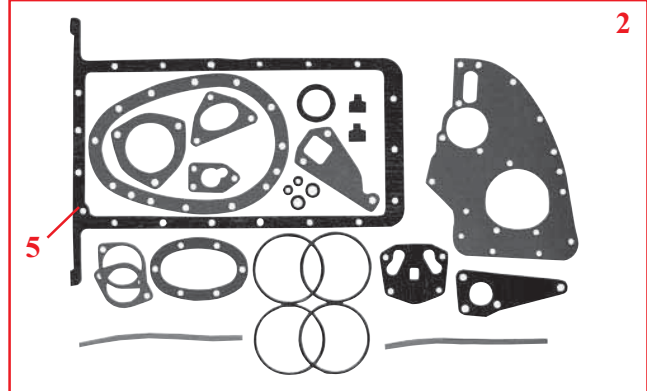
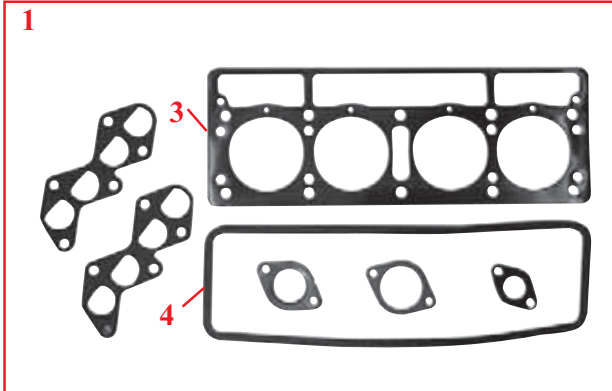

		1	2	3	4	5	
	Tracteurs Tractors	Moteur Engine	Pochette rodage Top gasket set	Pochette compl. Bottom gasket set	Joint de culasse Cyl. head gasket	Joint cache soupape Rocker cover gasket	Joint carter Sump gasket
4	Moissonneuses-batteuses moteurs 4 cylindres / 4 cylinder engines combines						
	186	A4.212	30/71-10 (U5LT1014, 4224186M91)	30/72-113 (F) (U5LB0146, U5LB1160, 3641075M91, 4224457M91)	30/73-11 (3681E021, 3638845M1)	30/74-11 (3681A027, 3638482M1)	30/75-106 (3681K005, 3640406M1)
	8 Plot, 10 Plot, 16 Plot, 16, 99, 187, 206, 240, 307, 330	A4.236					
	20XP (⇒ U027773M) Premiers blocs alésage 103.19mm Early blocks 103.19mm bore Ø	AT4.236					
	20XP (U027774M ⇒) Demi blocs alésage 104.20mm Later blocks 104.20mm bore Ø	AT4.236					
	430, 440, 487, 506	A4.248					
	20 (⇒ U108196N) Avec anneau pare-flamme With flame ring	A4.248			30/73-11 (3681E021, 3638845M1)		
	20 (U108197N ⇒) Sans anneau pare-flamme Without flame ring	A4.248	30/71-52 (U5LT1004, 4224189M91)		30/73-52 (3681E036, 4222500M1)		
6	Moissonneuses-batteuses moteurs 6 cylindres / 6 cylinder engines combines						
	500, 507, 510, 515, 520, 525	A6.354	30/71-12 (U5LT1181, 4224167M91)	30/72-12 (U5LB1224, 4224120M91)	30/73-12 (36812546, 740377M1)	30/74-15 (36811412, 733834M1)	
	24, 27, 530, 530S, 535, 800, 805, 810, 815	A6.354.4	30/71-59 (U5LT1190, 4224053M91)	30/72-57 (U5LB1225, 4224049M91)	30/73-56 (3681H202, 3638305M1)	30/74-32 (21826362, 4223925M1)	
	750, 760	AT6.354.1	30/71-35 (U5LT1186, 4224152M91)	30/72-12 (U5LB1224, 4224120M91)	30/73-35 (36812547, 740376M1)	30/74-17 (36811451, 4222942M1)	
	29, 29XP, 31, 560, 565, 660, 665, 750, 760, 820, 825, 830, 835, 840, 845, 850, 855, 860	AT6.354.4	30/71-59 (F) (U5LT1190, U5LT1192, 4224053M91, 4224090M91)	30/72-57 (U5LB1225, 4224049M91)	30/73-56 (3681H202, 3638305M1)	30/74-32 (21826362, 4223925M1)	30/75-110 (U5MK0398, 4224291M1)
	31XP	AT6.354.4					
	620, 625	A6.372		30/72-12 (U5LB1224, 4224120M91)	30/73-35 (36812547, 740376M1)	30/74-15 (36811412, 733834M1)	
	740, 750	A6.372	30/71-35 (U5LT1186, 4224152M91)			30/74-17 (36811451, 4222942M1)	
	750	A6.372.4		30/72-57 (U5LB1225, 4224049M91)		30/74-32 (21826362, 4223925M1)	

(F) Jeu complet couvrant toutes les applications reprises / Comprehensive set fitting all mentioned applications

Les références des pièces sont indicatives.
Nos pièces ne sont pas d'origine

Part numbers are quoted for reference purposes only.
Our parts and accessories are not original.



JOINTS DE MOTEUR ENGINE GASKET SETS

		1	2	3	4	5	
Tracteurs Tractors	Moteur Engine	Pochette ro dage Top gasket set	Pochette compl. Bottom gasket set	Joint de culasse Cyl. head gasket	Joint cache soupape Rocker cover gasket	Joint carter Sump gasket	
Chargeurs télescopiques / Telescopic handlers							
24	A4.236	30/71-52 (U5LT1004, 4224189M91)	30/72-10 (U5LB0145, 3640719M91)	30/73-52 (3681E036, 4222500M1)	30/74-11 (3681A027, 3638482M1)	30/75-106 (3681K003, 3681K005, 3641273M1, 3640406M1)	
24T	AT4.236	30/71-53 (U5LT1006, 4224246M91)		30/73-53 (3681E034, 4222124M1)			
8925, 8926, 8937, 8939	1004.4 (Blue)	30/71-90 (F) (U5LT1178, U5LT1196, 4224621M91, 4224623M91)	30/72-90 (U5LB1164, 4224595M91)	30/73-90 (3681E037, 4224501M1)	30/74-105 (3681A032, 3641891M1)		
8925T, 8926T, 8937T, 8939T	1004.4T (Blue)						
8925, 8926, 8937, 8939	1004.42 (Green)	30/71-83 (U5LT0317, 4223451M91)		30/73-83 (3681E042, 4223146M1)	30/74-108 (3681A049, 4224452M91)		
8925T, 8926T, 8937T, 8939T	1004.40T (Green)	30/71-82 (U5LT1202, 4224635M91)		30/73-90 (3681E037, 4224501M1)			
Tracteurs industriels moteurs 3 cylindres / 3 cylinder engine industrial tractors							
203, 205	A3.152	30/71-3 (U5LT0512, 4222562M91)	30/72-5 (B) (U5LB1157, 4224142M91)	30/73-3 (36812142, 4223582M1)	30/74-5 (0490491, 731273M1)	30/75-4 (D) (U5LB0501, 4223524M91)	
20, 40	AG3.152	30/71-9 (U5LT0537, 4223123M91)					
20, 20B, 20C, 20D, 20E, 20F, 30B, 30E, 30H, 40, 203, 205, 2135, 2203, 2205	AD3.152	30/71-5 (A) (U5LT1138, U5LT5138, 4223922M91, 4223923M91)			30/73-4 (C) (3681E024, 3641399M1)	30/74-8 (36811115, 735057M1)	30/75-105 (D) (21826370, 4224249M91)
40E	AT3.152.4	30/71-5 (A) (U5LT1139, 4223921M91)					

(A) Utilisable avec les moteurs normaux et turbo / Suitable for both normally aspirated & turbo charged engines

(B) Utilisable avec les moteurs à bague arrière une ou deux pièces / Suitable for both rope seal & lip seal blocks

(C) Disponible aussi en version cuivre 30/73-4A (36812127, 735018M2) / Copper gasket alternative available 30/73-4A (36812127, 735018M2)

(D) Joint de carter livré complet avec les joints en liège avant & arrière / Sump gasket is supplied complete with front & rear cork joints

(F) Jeu compréhensif couvrant toutes les applications reprises / Comprehensive set fitting all mentioned applications

Les références des pièces sont indicatives.
Nos pièces ne sont pas d'origine

Part numbers are quoted for reference purposes only.
Our parts and accessories are not original.



JOINTS DE MOTEUR ENGINE GASKET SETS

		1	2	3	4	5	
Tracteurs Tractors	Moteur Engine	Pochette rodage Top gasket set	Pochette compl. Bottom gasket set	Joint de culasse Cyl. head gasket	Joint cache soupape Rocker cover gasket	Joint carter Sump gasket	
Tracteurs industriels moteurs 4 cylindres / 4 cylinder engine industrial tractors							
702	23C Diesel	30/71-2 (1810028M91)	30/72-2 (1810027M91)	30/73-2 (1882771M1)	30/74-4 (826194M1)	30/75-111 (3910274M1)	
356	A4.203	30/71-7 (U5LT0509, 4222455M91)	30/72-6 (U5LB0502, 4223525M91)	30/73-7 (36812141, 4222122M1)	30/74-6 (0490704, 731164M1)	30/75-108 (E) (41424238, 4224063M91)	
30, 40B, 50, 302, 304, 356, 3165, 3303, 3305 (⇒ 29C1083) <i>Bague arrière 2 pièces / Rope seal</i>	AD4.203	30/71-8 (U5LT0100, 4222920M91)	30/72-9 (U5LB1117, 4223940M91)	30/73-8 (3681E023, 3641182M1))	30/74-9 (36811112, 732821M1)	30/75-109 (E) (41424239, 21826401, 4222934M1, 4224379M1)	
30, 40B, 50, 302, 304, 356, 3165, 3303, 3305 (29C1084 ⇒) <i>Bague arrière 1 pièce / Lip seal</i>	AD4.203						
50, 50B, 3303, 3305	A4.212	30/71-10 (U5LT1014, 4224186M91)	30/72-10 (U5LB0145, 3640719M91)	30/73-11 (3681E021, 3638845M1)	30/74-11 (3681A027, 3638482M1)	30/75-106 (3681K003, 3641273M1)	
30D, 50, 50B, 50B MKII, 50C, 50D, 50E, 50H, 60 <i>Premiers blocs alésage 103.19mm Early blocks 103.19mm bore Ø</i>	A4.236						
30D, 50, 50B, 50B MKII, 50C, 50D, 50E, 50H, 50H-S, 50H-T, 60 <i>Derniers blocs alésage 104.20mm Later blocks 104.20mm bore Ø</i>	A4.236						
60HX, 60HX-T	AT4.236	30/71-52 (U5LT1004, 4224189M91)	30/73-52 (3681E036, 4222500M1)	30/73-53 (3681E034, 4222124M1)	30/74-11 (3681A027, 3638482M1)	30/75-106 (3681K003, 3641273M1)	
50EX, 50HX, 60H <i>Avec anneau pare-flamme With flame ring</i>	A4.248	30/71-53 (U5LT1006, 4224246M91)					
50EX, 50HX, 60H 50HX-S, 50HX-T, 60HS <i>Sans anneau pare-flamme Without flame ring</i>	A4.248	30/71-10 (U5LT1014, 4224186M91)					
70	A4.318	30/71-52 (U5LT1004, 4224189M91)	30/71-31 (U5LT0520, 4223502M91)	30/72-31 (U5LB0221, 4223129M91)	30/73-31 (36812348, 745730M1)	30/74-13 (3681A008, 746036M1)	30/75-121 (21826314, 4223002M1)
Fermeq & Terex - Tracteurs industriels moteurs 4 cylindres / 4 cylinder engine industrial tractors							
750	1004.4 (Blue)	30/71-90 (F) (U5LT1178, U5LT1196, 4224621M91, 4224623M91)	30/72-113 (U5LB1160, 4224457M91)	30/73-90 (3681E037, 4224501M1)	30/74-105 (3681A032, 3641891M1)	30/75-106 (3681K003, 3641273M1)	
760, 860, 860S, 860SE, 865, 960, 965	1004.4T (Blue)	30/71-82 (U5LT1202, 4224635M91)	30/72-113 (U5LB1160, 4224457M91)	30/73-83 (3681E042, 4223146M1)	30/74-108 (3681A049, 4224452M91)		
750, 750B	1004.42 (Green)						
760, 760B, 860, 860B, 860S, 860SE, 960, 960B, 965	1004.40T (Green)	30/71-82 (U5LT1202, 4224635M91)	30/72-113 (U5LB1160, 4224457M91)	30/73-90 (3681E037, 4224501M1)	30/74-108 (3681A049, 4224452M91)		

(E) Joint de carter livré complet avec les joints en liège arrière / *Sump gasket is supplied complete with rear cork joint*
 (F) Jeu compréhensif couvrant toutes les applications reprises / *Comprehensive set fitting all mentioned applications*

Les références des pièces sont indicatives.
 Nos pièces ne sont pas d'origine









"THE RELIABLE SERVICE"



Part numbers are quoted for reference purposes only.
 Our parts and accessories are not original.

LOCTITE®
LOCTITE®

Réf. Ref.	Fig. Fig.	Désignation Description	OEM OEM
Freinage de filet / Thread fixing			
78/9604-101 50 ml		Loctite 243 Efficace sur tous les éléments filetés métalliques. S'oppose au desserrage de pièces sous contraintes de vibrations telles les vis de pompes ou de moteurs, écrous de cache-culbuteurs, vis de carters de boîtes de vitesses ou de presse. Recommandé pour des pièces dont le démontage est possible à l'aide d'un outillage classique et pour des pièces en l'état telles que roues et non dégraissées. <i>Effective on all types of metal threaded fasteners. Prevents loosening on vibrating parts such as pumps, motor mounting bolts, gear boxes or presses. Recommended for use where disassembly with hand tools is required for servicing and where parts are contaminated with oil.</i>	1810590M1, 3405351M1
78/9604-103 10 ml		Loctite 243 Efficace sur tous les éléments filetés métalliques. S'oppose au desserrage de pièces sous contraintes de vibrations telles les vis de pompes ou de moteurs, écrous de cache-culbuteurs, vis de carters de boîtes de vitesses ou de presse. Recommandé pour des pièces dont le démontage est possible à l'aide d'un outillage classique et pour des pièces en l'état telles que roues et non dégraissées. <i>Effective on all types of metal threaded fasteners. Prevents loosening on vibrating parts such as pumps, motor mounting bolts, gear boxes or presses. Recommended for use where disassembly with hand tools is required for servicing and where parts are contaminated with oil.</i>	3930904M1, 1633266M1, 3405350M1
78/9604-102 50 ml		Loctite 271 A utiliser sur tous éléments métalliques (y compris les matériaux passifs tels que les aciers inoxydables et les aciers revêtus d'un traitement de surface comme le zinc par exemple). Recommandé pour le blocage permanent de goujons et boulons sur blocs-moteurs, corps de pompes. <i>For use on all metal fasteners (including stainless steels and those with protective coatings such as zinc) where regular removal for maintenance is not required. Recommended for permanently locking studs on engine blocks and pump housings.</i>	3303219M1, 1810581M1, 1810589M1, 3405353M1, 3405352M5, 3405352M5, 3930908M1
Etanchéité hydraulique / Hydraulic sealant			
78/9604-121 50 ml		Loctite 542 Recommandé sur les raccords à filets fins utilisés dans les circuits hydrauliques et pneumatiques, ainsi que pour des équipements industriels et des petits raccords en général. <i>Recommended for fine threaded fittings as used in hydraulic and pneumatic installations, for connections on machine tools, automotive vehicles, heavy plant equipment and small fittings in general.</i>	3304296M1
Bloppresse			
78/9604-110 50 ml		Loctite 603 Développé pour les emmanchements à faible jeu (jeu diamétral jusqu'à 0,1 mm) et pour une utilisation sur pièces dont le dégraissage ne peut être absolu. Recommandé pour la fixation de roulements. <i>For retaining close fitting cylindrical parts (up to 0.1 mm gap). For use on cylindrical fitting parts where thorough degreasing is not possible.</i>	3303220M1
78/9604-113 50 ml		Loctite 648 Recommandé pour l'assemblage de pièces à faible jeu ou faible serrage comme par exemple, les bagues de fixation, les roulements, les joints, les ventilateurs et les chemises de cylindres. <i>Recommended for retaining parts with a clearance or interference fit, i.e. retaining bushes, bearings, seals, fans, and liners.</i>	892054M1, 1633268M1

Les références des pièces sont indicatives.
Nos pièces ne sont pas d'origine

Part numbers are quoted for reference purposes only.
Our parts and accessories are not original.



LOCTITE®
LOCTITE®

Réf. Ref.	Fig. Fig.	Désignation Description	OEM OEM
Étanchéité des plans de joints / Thread fixing			
78/9604-130 50 ml		Loctite 510 Recommandé pour l'étanchéité des plans de joints rigides sur pompes, manchons, boîtes de vitesses et carters. Loctite® 510 est thixotrope, il peut être appliqué sans risque de coulure sur des surfaces verticales. <i>Recommended for gasketing rigid surface on pumps, sleeves, gear box and housings. Loctite® 510 is thixotrop and can be set less running on vertical surface</i>	982580M2, 982211M1, 975008M1, 982041M2, 3930274M92, 3900613M2, 1610311M2, 1610449M2, 1610378M1, 1633270M2, 1617849M1, 1610240M1, 1612487M1, 1610613M1, 1633270M3, 1425202M1, 1425422M1, 1425466M1, 1425200M1, 1426565M1, 1423566M1, 1425199M1, 1425197M1, 1425178M1, 1825006M1, 1819877M1, 1821823M1, 1823590M1, 1870869M2, 1825353M1, 1824661M1, 1823648M1
78/9604-143 50 ml		Loctite 5926 Silicone RTV bleu. Joint en silicone flexible en permanence pour plan de joint de toute taille et forme. Fixation rapide. Idéal pour une vaste gamme d'applications agricoles. <i>Silicone Blue RTV. Permanently flexible silicone rubber sealant for gasketing flanges in any size and shape. Sets very quickly. Ideal for a wide range of automotive applications.</i>	1642923M1
78/9604-139 300 ml		Loctite 5699 Pâte silicone grise de forte viscosité et grande résistance mécanique. <i>Silicone paste of strong viscosity and high mechanic resistance.</i>	
78/9604-140 300 ml		Loctite 5910 Remplacement de joints conventionnels en papier ou en liège des couvercles en têtes embouties. <i>Replacement for cork and paper cut gaskets on flanges and stamped sheet metal covers.</i>	
Adhésifs / Lime			
78/9604-150 (20g)		Loctite 401 Adhésif multi-usages pour des substrats tels que plastiques, caoutchoucs, métaux, cartons, bois. <i>General purpose for bonding most substrates such as plastics, rubber, paper/card, wood and metals.</i>	3405356M1
Nettoyage / Cleaning			
78/9604-221 3 Ltr.		Loctite 7850 A base d'essence d'agrumes et autres agents hydratants de la peau sans huiles minérales. Biodégradable. Efficace avec ou sans eau. Enlève les graisses, goudron, colles, peintures et salissures diverses. <i>Natural hand cleaner made from citrus extracts and free from mineral oil. Contains premium skin conditioners. Biodegradable. Works with or without water.</i>	3930906M1

Les références des pièces sont indicatives.
Nos pièces ne sont pas d'origine

Part numbers are quoted for reference purposes only.
Our parts and accessories are not original.



**DISTRIBUTION
TIMING GEAR**

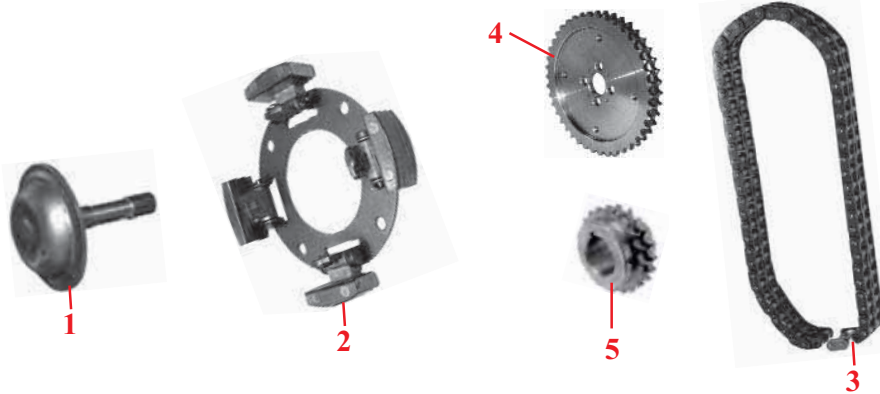

Tracteurs Tractors	Moteur Engine	1 Butée de régulateur Cup & shaft assy.	2 Régulateur Governor weight assy.	3 Chaîne de distribution Timing chain	4 Pignon d'arbre à came Camshaft sprocket	5 Pignon de vilebrequin Crankshaft sprocket
Moteurs 4 cylindres / 4 cylinder engines						
TEA20 TED20 TEH20 35, 135	85mm Petrol 85mm VO 85mm LO 87mm Petrol	30/6690-1 (825157M91)	30/6689-1 (825890M91)	30/6691-1 (825199M1)	30/81-4 (825135M1)	30/12-17 (825136M1)
TEF20	20C Diesel			30/6691-4 (61471)		
FE35, 835 702 (Industriel/ Industrial)	23C Diesel			30/6691-5 (826094M1)		

Tracteurs Tractors	Moteur Engine	Réf. Ref.	Fig.	OEM	Description
Moteurs 4 cylindres / 4 cylinder engines					
TEA20 TED20 TEH20 35, 135	85mm Petrol 85mm VO 85mm LO 87mm Petrol	30/980-1	6	408335, 829927M1	Rotor Rotor arm
		30/981-1	7	423153	Rupteur d'allumage Contact set
		30/982-1	8	407044, 829924M1, 1750451M1	Condensateur Condenser
		30/983-1	9	829937M1, 1714844M1	Tête de distributeur Distributor cap
		30/984-1	10	570062M3	Bobine d'allumage Ignition coil



Tracteurs Tractors	Moteur Engine	Couvercle Timing gear
35, 133, 135	A3.144	30/79-1 (ZZ90039, 3637397M91)
35	A3.152	
133, 134, 135, 140, 145, 148, 150, 152, 154, 230, 233, 234, 235, 240, 244CF, 245, 250, 253 (Italy), 254, 255, 335, 334V, 340, 342, 350, 353, 354, 356CF, 550, 2205, 3210	AD3.152	
164T, 253 (UK), 263T, 264T, 352, 355, 360, 363, 364, 366CF	AT3.152.4	

Les références des pièces sont indicatives.
Nos pièces ne sont pas d'origine

Part numbers are quoted for reference purposes only.
Our parts and accessories are not original.



**DISTRIBUTION
TIMING GEAR**

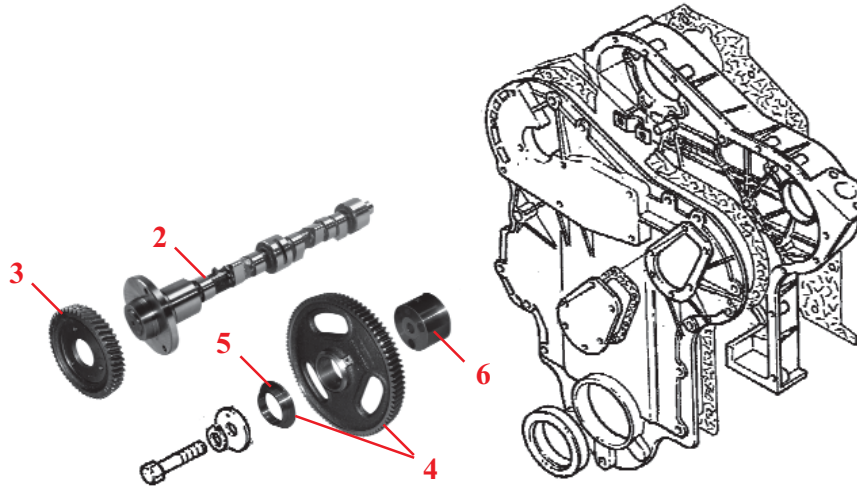

Tracteurs Tractors	Moteur Engine	1 Bague Camshaft bush	2 Arbre à cames Camshaft	3 Pignon Camshaft gear	4 Pignon Idler gear	5 Bague Idler gear bush	6 Axe Idler hub
3 Moteurs 3 cylindres / 3 cylinder engines							
35, 133, 135	A3.144						
35	A3.152						
135	AG3.152						
133, 134, 135, 140, 145, 148, 150, 152, 154, 230, 233, 234, 235, 240, 244CF, 245, 250, 253 (Italy), 254, 255, 333, 340, 353, 356CF, 550	AD3.152		30/80-1 (31415261, 733507M1)	30/81-1 (3116K111, 4224245M1)	30/82-1 (31164362, 731205M2)		
334V (CE31218)							
354, 3210 (CE31197)							
334V (CE31213)							
354, 3210 (CE31212)	AD3.152			30/81-13 (3117F081, 4222611M1)	30/82-13 (4111A015, 3638219M91)	30/84-7 (2511A735, 3637942M1)	
342, 350, 2205							
164T, 253 (UK), 263T (Italy), 264T	AT3.152.4			30/81-1 (3116K111, 4224245M1)	30/82-1 (31164362, 731205M2)		30/83-3 (0995447, 731204M1)
363, 364, 366CF (CN31198 ⇒ U998665D)							
352	AT3.152.4		30/80-6 (31415264, 3637539M1)	Fonte/Cast iron 30/81-1 (3116K111, 4224245M1) Acier / Steel 30/81-13 (3117F081, 4222611M1)			
355, 360							
363, 364, 366CF (CN31198 U998666D ⇒)	AT3.152.4				30/82-13 (4111A015, 3638219M91)	30/84-7 (2511A735, 3637942M1)	
364 (CN31225)							
2210, 3315, 4215, 4315	903.27						
263 (UK), 2220, 3325, 4220, 4320	903.27T			30/81-13 (3117F081, 4222611M1)			

Les références des pièces sont indicatives.
Nos pièces ne sont pas d'origine

Part numbers are quoted for reference purposes only.
Our parts and accessories are not original.



"THE RELIABLE SERVICE"



**DISTRIBUTION
TIMING GEAR**

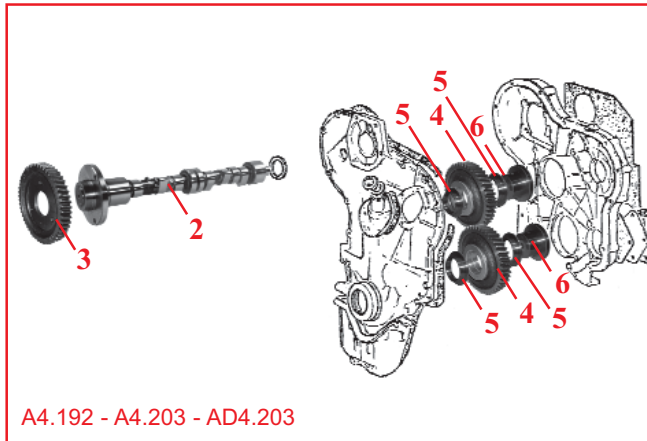

A4.192 - A4.203 - AD4.203

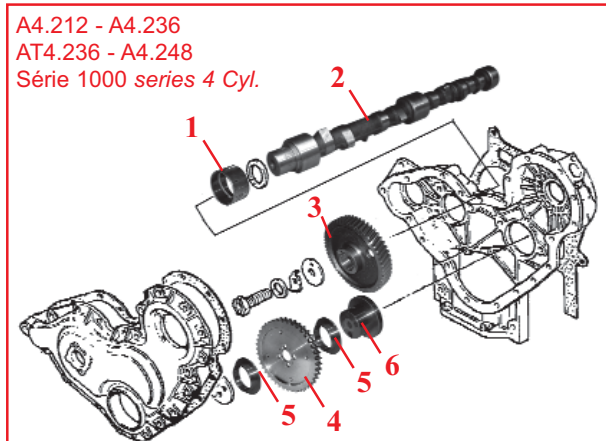

A4.212 - A4.236
AT4.236 - A4.248
Série 1000 series 4 Cyl.

Tracteurs Tractors	Moteur Engine	1 Bague Camshaft bush	2 Arbre à cames Camshaft	3 Pignon Camshaft gear	4 Pignon Idler gear	5 Bague Idler gear bush	6 Axe Idler hub
4 Moteurs 4 cylindres / 4 cylinder engines							
65	A4.192				Sup. / Upper 30/82-2 (0410227, 731034M1)	Sup. / Upper	
65, 865	A4.203				Inf. / Lower 30/82-3 (0994946, 731628M91)	Inf. / Lower 30/84-8 (0050345, 731033M1)	
65, 155, 158, 165, 765 (⇒ UA84217D)	AD4.203			30/81-2 (0410231, 731028M1)	Sup. / Upper 30/82-15 (41115005, 740865M91)		
65, 155, 158, 165, 765 (UA84218D ⇒) 158MKIII, 260, 560	AD4.203				Inf. / Lower 30/82-3 (0994946, 731628M91)		
165, 174	A4.212			⇒ U106654N 30/81-3 (31171353, 736254M1)	30/82-4 (41115023, 734738M91)		30/83-1 (33426161, 735852M1)
168, 168MKIII, 174, 175, 184, 255 (USA), 265, 273, 274, 275, 283, 284, 565, 575, 675	A4.236		⇒ U106654N 30/80-4 (A) (31415321, 736818M1)	U106655N ⇒ 30/81-14 (3117L012, 3641740M1)		30/84-8 (0050345, 731033M1)	
362, 362N, 365, 372N, 375	A4.236	30/56-1 (31134165, 4222017M1)	U106655N ⇒ 30/80-7 (B) (31415374, 3637537M1)	⇒ U106654N 30/81-10 (31171138, 3637421M1)	⇒ U171963P 30/82-12 (4111A013, 3637075M91)		
275E, 367CF, 373, 374, 375E, 376C, 377, 383, 387, 3050, 3220, 3225	A4.236		30/80-7 (31415375, 3641841M91)	U106655N ⇒ 30/81-12 (3117L023, 3641739M1)	⇒ U171964P ⇒ 30/82-14 (4111A016, 3638220M91)		
				30/81-14 (3117L012, 3641740M1)	30/82-4 (41115023, 734738M91)		

(A) Lobes d'arbre à cames élévation rapide / Fast lift camshaft lobes
(B) Lobes d'arbre à cames élévation lente / Slow lift camshaft lobes

Les références des pièces sont indicatives.
Nos pièces ne sont pas d'origine

Part numbers are quoted for reference purposes only.
Our parts and accessories are not original.



**DISTRIBUTION
TIMING GEAR**

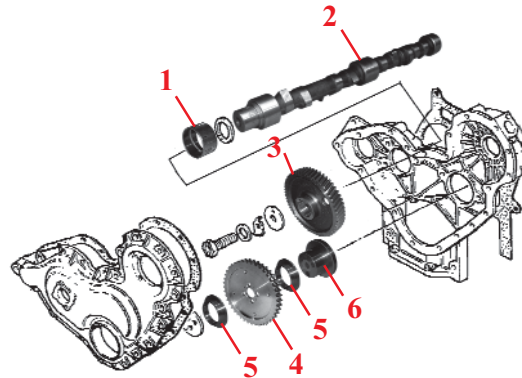

Tracteurs Tractors	Moteur Engine	1 Bague Camshaft bush	2 Arbre à cames Camshaft	3 Pignon Camshaft gear	4 Pignon Idler gear	5 Bague Idler gear bush	6 Axe Idler hub
Moteurs 4 cylindres / 4 cylinder engines							
390T, 398	AT4.236		30/80-13 (31415384, 3641843M91)	30/81-12 (3117L023, 3641739M1)	⇒ U171963P 30/82-12 (4111A013, 3637075M91) U171964P ⇒ 30/82-14 (4111A016, 3638220M91)		
393TLX, 394TAQ, 396CT, 397T, 698T, 1004T, 3065, 3065S, 3070	AT4.236		⇒ U083371N U083372N ⇒ 30/80-13 (B) (31415384, 3641843M91)	⇒ U083371N 30/81-3 (31171353, 736254M1) U083372N ⇒ 30/81-14 (3117L012, 3641740M1)			
1007	AT4.236	30/56-1 (31134165, 4222017M1)	30/80-13 (31415384, 3641843M91) ⇒ U108196N 30/80-4 (A) (31415321, 736818M1) U108197N ⇒ 30/80-7 (B) (31415375, 3641841M91)	30/81-14 (3117L012, 3641740M1) ⇒ U108196N 30/81-3 (31171353, 736254M1) U108197N ⇒ 30/81-14 (3117L012, 3641740M1)		30/84-8 (0050345, 731033M1)	30/83-1 (33426161, 735852M1)
178, 185, 188, 194, 285, 290, 293, 294, 590, 690, 3055, 3060	A4.248			30/81-14 (3117L012, 3641740M1)	30/82-4 (41115023, 734738M91)		
290E, 390E, 393, 394, 396C, 397, 3235	A4.248			30/81-14 (3117L012, 3641740M1)			
382N, 390	A4.248		30/80-7 (31415375, 3641841M91)	30/81-12 (3117L023, 3641739M1)	⇒ U171963P 30/82-12 (4111A013, 3637075M91) U171964P ⇒ 30/82-14 (4111A016, 3638220M91)		

(A) Lobes d'arbre à cames élévation rapide / Fast lift camshaft lobes
(B) Lobes d'arbre à cames élévation lente / Slow lift camshaft lobes

Les références des pièces sont indicatives.
Nos pièces ne sont pas d'origine

Part numbers are quoted for reference purposes only.
Our parts and accessories are not original.



**DISTRIBUTION
TIMING GEAR**

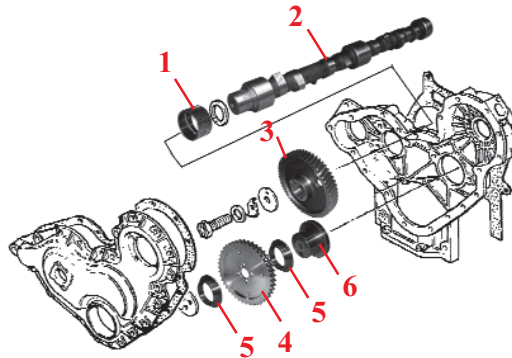

		1	2	3	4	5	6
Tracteurs Tractors	Moteur Engine	Bague Camshaft bush	Arbre à cames Camshaft	Pignon Camshaft gear	Pignon Idler gear	Bague Idler gear bush	Axe Idler hub
4 Moteurs 4 cylindres / 4 cylinder engines							
275E, 290E, 375E, 390E	A4.41	30/56-1 (31134165, 4222017M1)	30/80-12 (31415363, 3641840M91)	30/81-14 (3117L012, 3641740M1)	30/82-14 (4111A016, 3638220M91)	30/84-8 (0050345, 731033M1)	30/83-1 (33426161, 735852M1)
4225, 4235, 4240, 6110, 6120	A4.41 (Blue)				30/82-4 (41115023, 734738M91)		
3075, 6130, 6140, 6150	1004.4T			30/82-12 (4111A013, 3637075M91)			
4245, 4255	1004.4T (Blue)			30/81-12 (3117L023, 3641739M1)	30/82-14 (4111A016, 3638220M91)		
374, 3220, 3330	1004.40 (Green)			30/82-12 (4111A013, 3637075M91)	30/81-14 (3117L012, 3641740M1)		
3350, 3355	1004.40T			30/81-14 (3117L012, 3641740M1)	30/82-14 (4111A016, 3638220M91)		
4225, 4325	1004.40 (Green)		30/81-12 (3117L023, 3641739M1)	30/82-12 (4111A013, 3637075M91)			
4235, 4245, 4345, 6235, 6245	1004.40T (Green)						
4255, 4355, 6255	1004.40T (Green)		30/81-12 (3117L023, 3641739M1)	30/82-12 (4111A013, 3637075M91)			
4265, 4365, 6265	1004.40TW (Green)						
394, 2230, 3235, 3340	1004.42 (Green)		30/81-12 (3117L023, 3641739M1)	30/82-14 (4111A016, 3638220M91)			
4235 (USA), 4335	1004.42 (Green)						

Les références des pièces sont indicatives.
Nos pièces ne sont pas d'origine

Part numbers are quoted for reference purposes only.
Our parts and accessories are not original.



"THE RELIABLE SERVICE"



**DISTRIBUTION
TIMING GEAR**

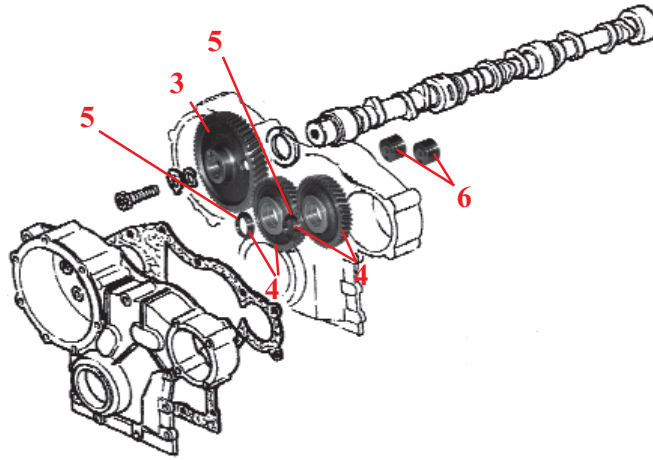

		3	4	5	6
Tracteurs Tractors	Moteur Engine	Pignon Camshaft gear	Pignon Idler gear	Bague Idler gear bush	Axe Idler hub
6 Moteurs 6 cylindres / 6 cylinder engines					
1100 1014, 1104, 1200	A6.354 A6.354.1	30/81-3 (31171353, 736254M1)		30/84-10 (31134121, 733733M1)	
1014 (TW31087 ⇒U725809L) 2620, 2625, 2675	A6.354.4		<i>Gauche / LH</i> 30/82-11 (41115056, 741263M91)		
399, 699 1014 (TW31087 U725810L ⇒) 1014 (TW31147), 1024, 1114, 1250, 2640, 2645, 3080, 3090, 3610	A6.354.4	30/81-10 (31171138, 3637421M1)	<i>Droit / RH</i> 30/82-10 (41115057, 741266M91)	30/84-9 (2511613, 741265M1)	30/83-2 (32718522, 741262M1)
1130	AT6.354			30/84-10 (31134121, 733733M1)	
1105 1135	ATC6.354.1 AT6.354.1				
2680, 2685	AT6.354.4	30/81-3 (31171353, 736254M1)	<i>Gauche / LH</i> 30/82-11 (41115056, 741263M91)	30/84-9 (2511613, 741265M1)	30/83-2 (32718522, 741262M1)
1134, 2705, 2720, 2725, 3630, 3650	AT6.354.4	30/81-10 (31171138, 3637421M1)	<i>Droit / RH</i> 30/82-10 (41115057, 741266M91)		

Les références des pièces sont indicatives.
Nos pièces ne sont pas d'origine

Part numbers are quoted for reference purposes only.
Our parts and accessories are not original.



**DISTRIBUTION
TIMING GEAR**

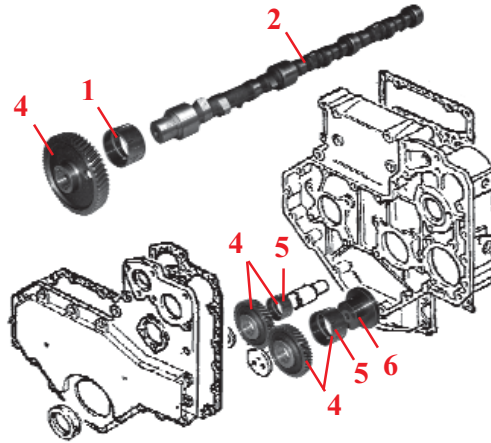

Tracteurs Tractors	Moteur Engine	1 Bague Camshaft bush	2 Arbre à cames Camshaft	3 Pignon Camshaft gear	4 Pignon Idler gear	5 Bague Idler gear bush	6 Axe Idler hub
6 Moteurs 6 cylindres / 6 cylinder engines							
396, 399, 3085, 3095, 3115, 4260, 4270, 6160, 6170	1006.6 (Blue)	30/56-1 (31134165, 4222017M1)	30/80-11 (31416307, 3641738M1)	30/81-12 (3117L023, 3641739M1)	Gauche / LH 63 dents/teeth 30/82-12 (4111A013, 3637075M91)	Gauche / LH 30/84-8 (0050345, 731033M1)	Gauche / LH 30/83-1 (33426161, 735852M1)
3120, 3120T, 3125, 3140, 3635 (YB31245), 6180	1006.6T (Blue)			30/81-14 (3117L012, 3641740M1)			
3635 (YB31262), 3645, 3655, 3660, 6190, 8110, 8120, 8130	1006.6T (Blue)						
4260, 4360, 6260	1006.60 (Green)			30/81-12 (3117L023, 3641739M1)	Droit / RH 27 dents/teeth 30/82-16 (4111A008, 748072M91)	Droit / RH 30/84-11 (2511437, 1447752M1)	Droit / RH
4270, 4370, 6170, 6180, 6270, 6280, 6290, 8120, 8210, 8220	1006.60T (Green)						

**SUPPORT INFERIEUR DE CARTER
LOWER TIMING GEAR HOUSING SUPPORT**

35, 133, 135	A3.144	30/6079-1 (37354312, 731214M1)
35	A3.152	
133, 134, 135, 140, 145, 148, 150, 152, 154, 230, 233, 234, 235, 240, 244CF, 245, 250, 253 (Italy), 254, 255, 333, 334V, 340, 342, 350, 353, 354, 356CF, 550, 2205, 3210	AD3.152	
164T, 253 (UK), 263T, 264T, 352, 355, 360, 363, 364, 366CF	AT3.152.4	



Les références des pièces sont indicatives.
Nos pièces ne sont pas d'origine

Part numbers are quoted for reference purposes only.
Our parts and accessories are not original.



**DISTRIBUTION
TIMING GEAR**

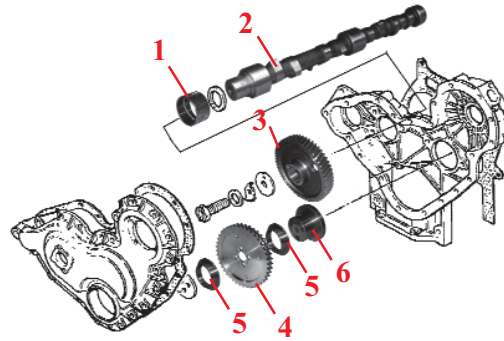

		1	2	3	4	5	6	
Tracteurs Tractors	Moteur Engine	Bague Camshaft bush	Arbre à cames Camshaft	Pignon Camshaft gear	Pignon Idler gear	Bague Idler gear bush	Axe Idler hub	
4 Moissonneuses-batteuses moteurs 4 cylindres / 4 cylinder engines combinées								
186	A4.212	30/56-1 (31134165, 4222017M1)	30/80-4 (31415321, 736818M1)	30/81-3 (31171353, 736254M1)	30/82-4 (41115023, 734738M91)	30/84-8 (0050345, 731033M1)	30/83-1 (33426161, 735852M1)	
8 Plot, 10 Plot	A4.236							
16 Plot, 16, 99, 187, 206, 240, 307, 330	A4.236							
20XP	AT4.236		⇒ U083371N	⇒ U083371N 30/81-10 (31171138, 3637421M1)	30/82-12 (4111A013, 3637075M91)			
430, 440, 487, 506	A4.248		U083372N ⇒ 30/80-13 (B) (31415384, 3641843M91)	U083372N ⇒ 30/81-12 (3117L023, 3641739M1)				
20	A4.248			⇒ U108196N 30/81-3 (31171353, 736254M1) U108197N ⇒ 30/81-14 (3117L012, 3641740M1)	30/82-4 (41115023, 734738M91)			

(A) Lobes d'arbre à cames élévation rapide / *Fast lift camshaft lobes*
(B) Lobes d'arbre à cames élévation lente / *Slow lift camshaft lobes*

Les références des pièces sont indicatives.
Nos pièces ne sont pas d'origine

Part numbers are quoted for reference purposes only.
Our parts and accessories are not original.



**DISTRIBUTION
TIMING GEAR**

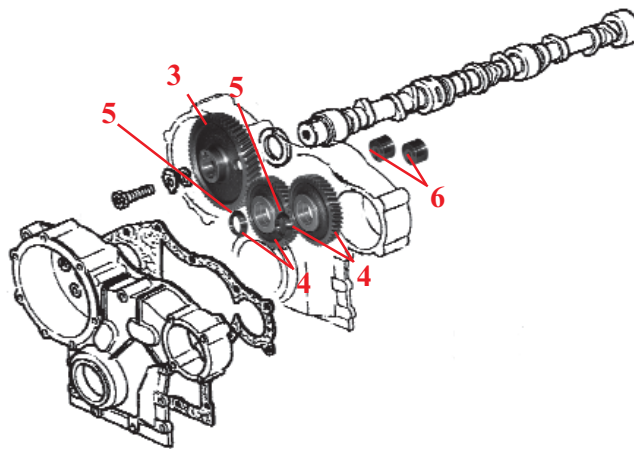

Tracteurs Tractors	Moteur Engine	3 Pignon Camshaft gear	4 Pignon Idler gear	5 Bague Idler gear bush	6 Axe Idler hub
6 Moissonneuses-batteuses moteurs 6 cylindres / 6 cylinder engines combines					
500, 507, 510, 515, 520, 525	A6.354	30/81-3 (31171353, 736254M1)		30/84-10 (31134121, 733733M1)	
620, 625, 740, 750	A6.372	30/81-10 (31171138, 3637421M1)			
24	A6.354.4	⇒ U544145E 30/81-3 (31171353, 736254M1) U544146E ⇒ 30/81-10 (31171138, 3637421M1)	<i>Gauche / LH</i> 30/82-11 (41115056, 741263M91) <i>Droit / RH</i> 30/82-10 (41115057, 741266M91)	30/84-9 (2511613, 741265M1)	30/83-2 (32718522, 741262M1)
27, 530, 530S, 535, 800, 805, 810, 815	A6.354.4	30/81-3 (31171353, 736254M1)			
750	A6.372.4				
750, 760	AT6.354.1	30/81-10 (31171138, 3637421M1)		30/84-10 (31134121, 733733M1)	
29	AT6.354.4	30/81-3 (31171353, 736254M1)	<i>Gauche / LH</i> 30/82-11 (41115056, 741263M91) <i>Droit / RH</i> 30/82-10 (41115057, 741266M91)	30/84-9 (2511613, 741265M1)	30/83-2 (32718522, 741262M1)
29XP, 31, 31XP, 560, 565, 660, 665, 750, 760, 820, 825, 830, 835, 840, 845, 850, 855, 860	AT6.354.4	30/81-10 (31171138, 3637421M1)			

Les références des pièces sont indicatives.
Nos pièces ne sont pas d'origine

Part numbers are quoted for reference purposes only.
Our parts and accessories are not original.



**DISTRIBUTION
TIMING GEAR**

A4.212 - A4.236
AT4.236 - A4.248
Série 1000 series 4 Cyl.

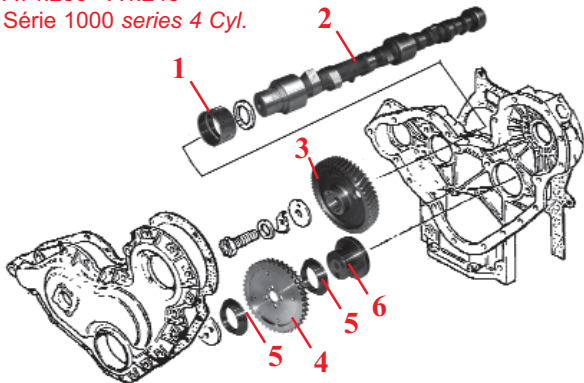

A3.152

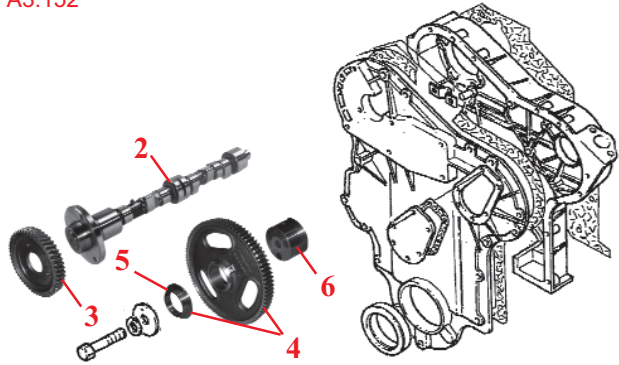

Tracteurs Tractors	Moteur Engine	1 Bague Camshaft bush	2 Arbre à cames Camshaft	3 Pignon Camshaft gear	4 Pignon Idler gear	5 Bague Idler gear bush	6 Axe Idler hub		
Chargeurs télescopiques / Telescopic handlers									
24	A4.236	30/56-1 (31134165, 4222017M1)	30/80-7 (31415375, 3641841M91)	30/81-12 (3117L023, 3641739M1)	30/82-12 (4111A013, 3637075M91)				
24T	AT4.236		30/80-13 (31415384, 3641843M91)						
8925, 8926, 8937, 8939	1004.4 (Blue)		30/80-12 (31415363, 3641840M91)	30/81-14 (3117L012, 3641740M1)	30/82-4 (41115023, 734738M91)			30/84-8 (0050345, 731033M1)	30/83-1 (33426161, 735852M1)
8925T, 8926T, 8937T, 8939T	1004.4T (Blue)			30/81-12 (3117L023, 3641739M1)	30/82-12 (4111A013, 3637075M91)				
8925, 8926, 8937, 8939	1004.42 (Green)		30/81-12 (3117L023, 3641739M1)					30/82-12 (4111A013, 3637075M91)	
8925T, 8926T, 8937T, 8939T	1004.40T (Green)								
Tracteurs industriels moteurs 3 cylindres / 3 cylinder engine industrial tractors									
203, 205	A3.152		30/80-1 (31415261, 733507M1)	30/81-1 (3116K111, 4224245M1)	30/82-1 (31164362, 731205M2)		30/83-3 (0995447, 731204M1)		
20, 40	AG3.152								
20, 20B, 20C, 20D, 20E, 20F, 30B, 30H, 40, 203, 205, 2135, 2203, 2205 30E (CE31116, CE31182, CE31183)	AD3.152								
30E (CE31144, CE31184)	AD3.152			30/82-13 (4111A015, 3638219M91)	30/84-7 (2511A735, 3637942M1)				
40E	AT3.152.4							30/80-6 (31415264, 3637539M1)	

Les références des pièces sont indicatives.
Nos pièces ne sont pas d'origine

Part numbers are quoted for reference purposes only.
Our parts and accessories are not original.



**DISTRIBUTION
TIMING GEAR**

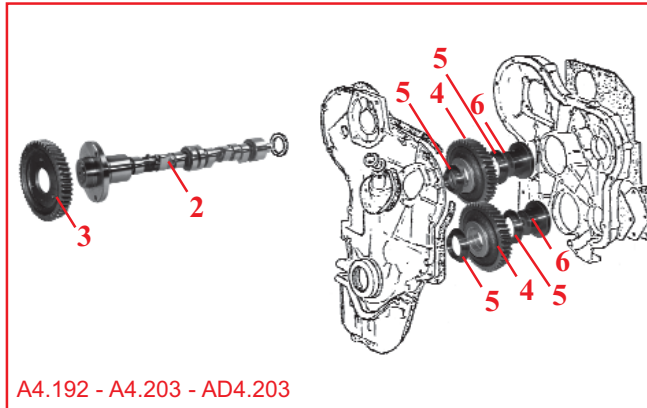

A4.192 - A4.203 - AD4.203

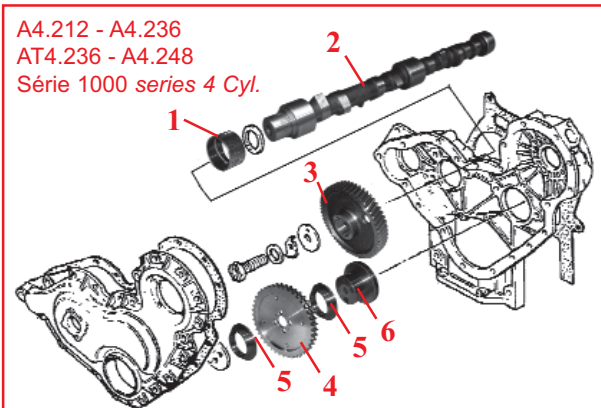

A4.212 - A4.236
AT4.236 - A4.248
Série 1000 series 4 Cyl.

Tracteurs Tractors	Moteur Engine	1 Bague Camshaft bush	2 Arbre à cames Camshaft	3 Pignon Camshaft gear	4 Pignon Idler gear	5 Bague Idler gear bush	6 Axe Idler hub
Tracteurs industriels moteurs 4 cylindres / 4 cylinder engine industrial tractors							
356	A4.203				Sup. / Upper 30/82-2 (0410227, 731034M1)	Sup. / Upper	
30, 40B, 50, 302, 304, 356, 3165, 3303, 3305 (⇒ UA84217D)	AD4.203				Inf. / Lower 30/82-3 (0994946, 731628M91)	Inf. / Lower 30/84-8 (0050345, 731033M1)	
30, 40B, 50, 302, 304, 356, 3165, 3303, 3305 (UA84218D ⇒)	AD4.203				Sup. / Upper 30/82-15 (41115005, 740865M91) Inf. / Lower 30/82-3 (0994946, 731628M91)		
50, 50B, 3303, 3305	A4.212			⇒ U106654N 30/81-3 (31171353, 736254M1)	30/82-4 (41115023, 734738M91)		30/83-1 (33426161, 735852M1)
30D, 50, 50B, 50B MKII, 50C, 50D, 60 50E (LD31113, LD31114)	A4.236		⇒ U106654N 30/80-4 (A) (31415321, 736818M1)	U106655N ⇒ 30/81-14 (3117L012, 3641740M1)			
50E (LD31132) 50H (LD31134, LD31163)	A4.236	30/56-1 (31134165, 4222017M1)	U106655N ⇒ 30/80-7 (B) (31415375, 3641841M91)	⇒ U106654N 30/81-10 (31171138, 3637421M1) U106655N ⇒ 30/81-12 (3117L023, 3641739M1)	30/82-12 (4111A013, 3637075M91)		30/84-8 (0050345, 731033M1)
50E (LD31178)	A4.236		30/80-7 (31415375, 3641841M91)	30/81-14 (3117L012, 3641740M1)	30/82-4 (41115023, 734738M91)		
50H (LD31179) 50H-S, 50H-T	A4.236			30/81-12 (3117L023, 3641739M1)	30/82-12 (4111A013, 3637075M91)		
60HX, 60HX-T	AT4.236		30/80-13 (31415384, 3641843M91)				

(A) Lobes d'arbre à cames élévation rapide / Fast lift camshaft lobes
(B) Lobes d'arbre à cames élévation lente / Slow lift camshaft lobes

Les références des pièces sont indicatives.
Nos pièces ne sont pas d'origine

Part numbers are quoted for reference purposes only.
Our parts and accessories are not original.



**DISTRIBUTION
TIMING GEAR**

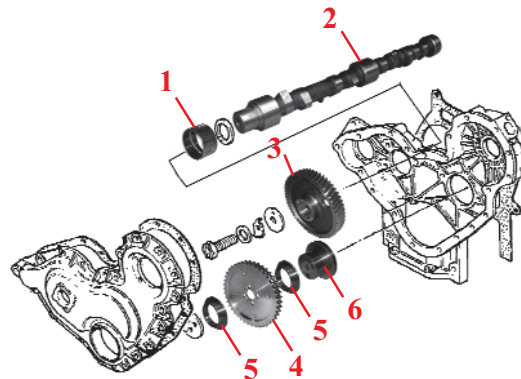

		1	2	3	4	5	6	
Tracteurs Tractors	Moteur Engine	Bague Camshaft bush	Arbre à cames Camshaft	Pignon Camshaft gear	Pignon Idler gear	Bague Idler gear bush	Axe Idler hub	
Tracteurs industriels moteurs 4 cylindres / 4 cylinder engine industrial tractors								
50EX	A4.248		30/80-7 (31415375, 3641841M91)	30/81-14 (3117L012, 3641740M1)				
50HX, 60H (LF31128)	A4.248	30/56-1 (31134165, 4222017M1)	⇒ U108196N 30/80-4 (A) (31415321, 736818M1)	⇒ U108196N 30/81-3 (31171353, 736254M1)	30/82-4 (41115023, 734738M91)	30/84-8 (0050345, 731033M1)	30/83-1 (33426161, 735852M1)	
50HX, 60H (LF31130, LF31135, LF31164)	A4.248		U108197N ⇒ 30/80-7 (B) (31415375, 3641841M91)	U108197N ⇒ 30/81-14 (3117L012, 3641740M1)				
50HX, 60H (LF31180) 50HX-S, 50HX-T, 60H-S	A4.248		U108197N ⇒ 30/81-12 (3117L023, 3641739M1)	⇒ U108196N 30/81-10 (31171138, 3637421M1)	30/82-12 (4111A013, 3637075M91)			
Fermec & Terex - Tracteurs industriels moteurs 4 cylindres / 4 cylinder engine industrial tractors								
750	1004.4 (Blue)	30/56-1 (31134165, 4222017M1)	30/80-12 (31415363, 3641840M91)	30/81-14 (3117L012, 3641740M1)				
760, 860, 860S, 860SE, 865, 960, 965	1004.4T (Blue)					30/82-12 (4111A013, 3637075M91)	30/84-8 (0050345, 731033M1)	30/83-1 (33426161, 735852M1)
750, 750B	1004.42 (Green)			30/81-12 (3117L023, 3641739M1)				
760, 760B, 860, 860B, 860S, 860SE, 960, 960B, 965	1004.40T (Green)							

(A) Lobes d'arbre à cames élévation rapide / Fast lift camshaft lobes
(B) Lobes d'arbre à cames élévation lente / Slow lift camshaft lobes

Les références des pièces sont indicatives.
Nos pièces ne sont pas d'origine

Part numbers are quoted for reference purposes only.
Our parts and accessories are not original.



COMMANDE AUXILIAIRE DE DISTRIBUTION
AUXILIARY DRIVE

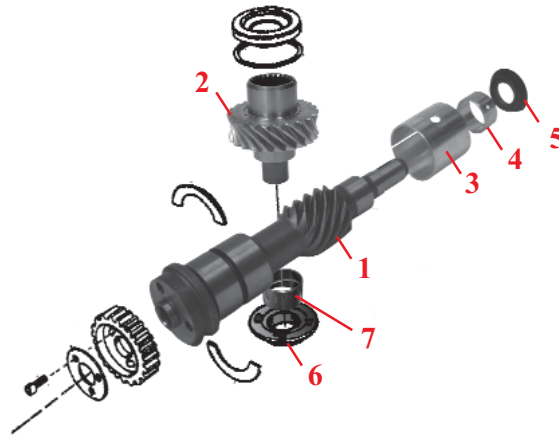

	1	2	3	4	5	6	7	
Tracteurs Tractors	Moteur Engine	Arbre Drive shaft	Pignon Gear-shaft assy.	Bague avt Front bush	Bague arr. Rear Bush	Bague Oil seal	Coussinet Thrust bearing	Bague Bush
6 Moteurs 6 cylindres / 6 cylinder engines								
1100 1200	A6.354 A6.354.1							
1014, 1104	A6.354.1		30/121-1 (41115367, 743924M91)	30/122-1 (31134129, 733887M1)	30/123-1 (2511447, 733770M1)	30/124-1 (B) (2415503, 3639297M1) 30/124-2 (2418F432, 3640765M1)	30/6121-1 (41425608, 744620M91)	30/6093-1 (2511636, 736612M1)
399, 699, 1014, 1024, 1114, 1250, 2620, 2625, 2640, 2645, 2675, 3080, 3090, 3610	A6.354.4	30/120-2 (A) (31173423, 744243M1)				30/124-2 (2418F432, 3640765M1)		
1105 1130 1135	ATC6.354.1 AT6.354 AT6.354.1							
1134, 2680, 2685, 2705, 2720, 2725, 3630, 3650	AT6.354.4	30/120-2 (A) (31173423, 744243M1)				30/124-2 (2418F432, 3640765M1)		
6 Moissonneuses-batteuses moteurs 6 cylindres / 6 cylinder engines combines								
500, 507, 510, 515, 520, 525	A6.354					30/124-1 (B) (2415503, 3639297M1)		
620, 625	A6.372					30/124-2 (2418F432, 3640765M1)		
750, 760	AT6.354.1		30/121-1 (41115367, 743924M91)	30/122-1 (31134129, 733887M1)	30/123-1 (2511447, 733770M1)		30/6121-1 (41425608, 744620M91)	30/6093-1 (2511636, 736612M1)
740, 750	A6.372							
24, 27, 530, 530S, 535, 800, 805, 810, 815	A6.354.4							
29, 29XP, 31, 31XP, 560, 565, 660, 665, 750, 760, 820, 825, 830, 835, 840, 845, 850, 855, 860	AT6.354.4	30/120-2 (A) (31173423, 744243M1)				30/124-2 (2418F432, 3640765M1)		
750	A6.372.4							

(A) 30/120-2 utilise un jeu de vis 3/8" UNF / 30/120-2 shaft take 3/8" UNF setscrews

(B) Le joint nitrile 30/124-1 est utilisé avec les premiers arbres 31173409. 30/124-2 est utilisé avec l'arbre 31173422, 743276M1.



30/124-1 is the nitrile seal used with the early drive shaft 31173409. 30/124-2 is used with the later drive shaft 31173422, 743276M1.

Les références des pièces sont indicatives.
Nos pièces ne sont pas d'origine

Part numbers are quoted for reference purposes only.
Our parts and accessories are not original.



**BOUCHONS DE REMPLISSAGE HUILE
OIL FILLER CAP**

Tracteurs <i>Tractors</i>	Moteur <i>Engine</i>	Réf. <i>Ref.</i>	Illustration <i>Illustration</i>
35, 133, 135	A3.144	30/85-2 (2487854, 2487841, 734962M91, 1851752M91)	
35	A3.152		
25, 122	A4.99		
25, 30, 130, 825	A4.107		
65	A4.192		
65, 865	A4.203		
65, 155, 158, 158, MKIII, 165, 260, 560765	AD4.203		
400, 410, 415	A4.300		
133, 134, 135, 140, 145, 148, 150, 152, 154, 230, 233, 234, 235, 240, 244CF, 245, 250, 253 (Italy), 254, 255, 333, 334V, 340, 342, 350, 353, 354, 356CF, 550, 2205, 3210	AD3.152		
253 (UK), 264TCF, 352, 355, 360, 363, 364, 366CF	AT3.152.4		
2210	903.27		
165, 174	A4.212		
168, 168MKIII, 174, 174C, 175, 184, 265, 274, 274S, 274SK, 275, 275E, 284, 375E, 377, 387, 565, 575, 675, 3050 174F/S, 184F/S, 273, 283 (Carter de distribution /Timing gear housing) 365, 375 (⇒ U382174U)	A4.236		
178, 185, 188, 194, 194C, 285, 290, 290E, 294S, 390E, 397, 590, 690, 3055, 3060 194F/S, 293, 294 (Carter de distribution /Timing gear housing) 390 (⇒ U382174U)	A4.248		
487, 506 (Carter de distribution /Timing gear housing)			
390T, 393TLX, 396CT, 397T, 398, 698T, 1004T, 1007, 3065, 3065S, 3070	AT4.236		
3075, 6130, 6140, 6150	1004.4T (Blue)		
2230	1004.42		
1200	A6.354.1		
850, 855, 860	AT6.354.4CC		
186	A4.212	30/85-3 (2487845, 1851753M1)	
174F/S, 184F/S, 273, 283 (Cache-soupapes / Rocker cover) 274C, 274CF, 284, 367CF, 373, 374, 376C, 383, 384, 3220, 3225 187 (Cache-soupape / Rocker cover), 8Plot, 10Plot, 16, 16Plot, 206, 240, 307, 330	A4.236		
194F/S, 293, 294 (Cache-soupapes / Rocker cover) 294C, 393, 394, 396C, 3235	A4.248		
487, 506 (Cache-soupapes / Rocker cover), 20, 430, 440			
788	A4.270		
4225, 4235, 4240 (1er modèles / Early)	A4.41 (Blue)		
4245, 4255 (1er modèles / Early)	1004.4T (Blue)		
500, 507, 510, 515, 520, 525	A6.354		
699, 1250	A6.354.4		
24, 530, 530S, 535, 800, 805, 810, 815			
27, 29, 29XP, 31, 31XP, 560, 565, 660, 665, 750, 760, 820, 825, 830, 835, 840, 845, 850, 855, 860	AT6.354.4		
620, 625, 740, 750	A6.372		
750	A6.372.4		
135	AG3.152		
135 (USA)	AD3.152		
99, 187 (Carter de distribution /Timing cover)	A4.236		
285 (USA), 592, 595, 1080, 1085	A4.318		
285 (USA), 298, 592, 595, 698, 1004	A4.318.2		
263 (UK)	903.27T	30/85-13 (2487983, 3639319M1)	
362, 362N, 372N 365, 375 (U382175U ⇒)	A4.236		
382N 390 (U382175U ⇒)	A4.248		

Les références des pièces sont indicatives.
Nos pièces ne sont pas d'origine

Part numbers are quoted for reference purposes only.
Our parts and accessories are not original.



JAUGES D'HUILE DIPSTICK

Tracteurs Tractors	Moteur Engine	Réf. Ref.	Illustration Illustration
35, 133, 135	A3.144	30/86-1 (31786412, 731117M91)	
35	A3.152		
135	AG3.152		
133, 134, 135, 140, 145, 148, 150, 152, 154, 230, 233, 234, 235, 240, 244CF, 245, 250, 253 (Italy), 254, 255, 333, 334V, 340, 342, 350, 353, 354, 356CF, 550, 2205	AD3.152		
164T, 253 (UK), 263T (Italy), 264T, 352, 355, 360, 363, 364, 366CF	AT3.152.4		
65	A4.192		
65, 865	A4.203		
65, 155, 158, 158MKIII, 165, 260, 560, 765	AD4.203		
165, 174	A4.212		
168, 174, 175, 184, 273,274S, 274SK, 283, 284S, 565, 575 168MKIII, 265, 274, 275, 675 (⇒ U917431K)	A4.236		
178, 185, 188, 194, 285, 293, 294S	A4.248		
362, 362N, 365, 375, 3050 372N (1er modèles / Early)	A4.236	30/86-5 (31787455, 747476M91)	
382N, 390 (1er modèles / Early) 3055, 3060	A4.248		
390T, 398 (1er modèles / Early) 698T (1984 ⇒), 1004T, 3065, 3065S, 3070	AT4.236		

BOUCHON DE CARTER SUMP PLUG

Tous modèles / All models

30/88-1
(2487004,
32186405,
376501X1,
748160M1)



ROBINETS BLOC BLOCK TAPS



Moteur Engine	Réf. Ref.	Illustration Illustration
Moteurs Standart Standart engines	30/55-5 (828085M1, 825326M1) 1/2" UNF	
Moteurs Perkins Perkins engines	30/55-2 (31419, 1851095M2) 1/4" BSP	

Les références des pièces sont indicatives.
Nos pièces ne sont pas d'origine

Part numbers are quoted for reference purposes only.
Our parts and accessories are not original.



POMPES À HUILE
OIL PUMPS

Tracteurs Tractors	Moteur Engine	Pompe à huile Oil pump	Pignon Idler gear	Bague Idler bush	Illustration Illustration
3 Moteurs 3 cylindres / 3 cylinder engines					
35, 133, 135	A3.144	30/90-1 (41314187, 3637359M91)	30/91-1 (41115086, 3637351M91)	30/84-5 (0050265, 731236M1)	
35	A3.152				
135	AG3.152				
133, 134, 135, 140, 145, 148, 150, 152, 154, 230, 233, 234, 235, 240, 244CF, 245, 250, 253 (Italy), 254, 255, 333, 334V, 340, 342, 350, 353, 354, 356CF, 550, 2205, 3210	AD3.152				
164T, 253 (UK), 263T (Italy), 264T, 352, 355, 360, 363, 364, 366CF	AT3.152.4				
2210, 3315, 4215, 4315	903.27				
263 (UK), 2220, 3325, 4220, 4320	903.27T				
4 Moteurs 4 cylindres / 4 cylinder engines					
25, 122	A4.99	30/90-11 (41314089, 3640285M1)			
25, 30, 130, 825	A4.107				
65	A4.192	30/90-2 (41314189, 3637471M91)	30/91-2 (0994967, 731635M91)		
65, 865	A4.203				
65, 155, 158, 158MKIII, 165, 260, 560, 765	AD4.203				
165 (UK) 174 (⇒ 212UA170105)	A4.212	30/90-3 (41314182, 3637470M91)	30/91-3 (41115085, 3637422M91)	30/84-11 (2511437, 1447752M1)	
168MKIII, 174, 184, 265, 273, 274, 275, 283, 284, 565, 575, 675 (U880191K ⇒)	A4.236	30/90-13 (A) (4132F041, 3637489M91)			
275E, 362, 362N, 365, 367CF, 372N, 373, 374, 375, 375E, 376C, 377, 383, 384, 387, 3050, 3220, 3225					
178, 185, 188, 194, 285, 290, 293, 294, 590, 690 (U880191K ⇒)	A4.248				
290E, 382N, 390, 390E, 393, 394, 396C, 397, 3055, 3060, 3235	AT4.236				
390T, 393TLX, 394TAQ, 396CT, 397T, 398, 698T, 1004T, 1007, 3065, 3065S, 3070					
285 (USA), 592, 595, 1080, 1085	A4.318	30/90-12 (41314113, 737964M92)			
285 (USA), 298, 592, 595, 698, 1004	A4.318.2				







(A) 30/90-13 est inclus dans l'équilibreur monté au milieu, voir page MF-114-115
30/90-13 is included in the mid-mounted balancer units see page MF-114-115

Les références des pièces sont indicatives.
Nos pièces ne sont pas d'origine

Part numbers are quoted for reference purposes only.
Our parts and accessories are not original.

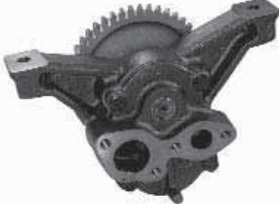

POMPES À HUILE
OIL PUMPS

Tracteurs Tractors	Moteur Engine	Pompe à huile Oil pump	Pignon Idler gear	Bague Idler bush	Illustration Illustration
4 Moteurs 4 cylindres / 4 cylinder engines					
275E, 290E, 375E, 390E, 4225, 4235, 4240, 6110, 6120	A4.41 (Blue)	30/90-13 (A) (4132F041, 3637489M91)			
3075, 4245, 4255, 6130, 6140, 6150	1004.4T (Blue)				
374, 3220, 3330, 4225, 4325	1004.40 (Green)				
3350, 3355, 4235, 4245, 4255, 4345, 4355, 6235, 6245, 6255	1004.40T (Green)				
4265, 4365, 6265	1004.40TW				
394, 2230, 3235, 3340, 4235 (USA), 4335	1004.42				
6 Moteurs 6 cylindres / 6 cylinder engines					
1100 1014, 1104, 1200	A6.354 A6.354.1	30/90-5 (41314067, 736012M91)			
1105 1130 1135	ATC6.354.1 AT6.354 AT6.354.1				
399, 699, 1014, 1024, 1114, 1250, 2620, 2625, 2640, 2645, 2675, 3080, 3090, 3610	A6.354.4	30/90-14 (4132F015, 747292M91)			
1134, 2680, 2685, 2705, 2720, 2725, 3630, 3650	AT6.354.4	30/90-23 (4132F016, 747293M91)			
396, 399, 3085, 3095, 3115, 4260, 4270, 6160, 6170	1006.6 (Blue)	30/90-51 (4132F043, 3638595M91)			
3120, 3120T, 3125, 3140, 3635, 3645, 3655, 3660, 6180, 6190, 8110, 8120, 8130	1006.6T (Blue)	30/90-54 (4132F057, 3641171M91)			
4260, 4360, 6260	1006.60 (Green)				
4270, 4370, 6170, 6180, 6270, 6280, 6290, 8120, 8210, 8220	1006.60T (Green)				
3680, 3690	612DS	30/90-57 (3637653M91, V836338187)			
3690, 8160	634DS	30/90-59 (3638940M91, V836322243, V836852607)			
8250, 8260 (⇒ J7890)	634DSBAE				
3670, 8140, 8150	620DS				
8240 (⇒ J7890)	620DSRAE				
8240 (J7891 ⇒)	620DSRAE				
8240 Xtra	620DWBAE				
8250, 8260 (J8791 ⇒)	634DSBAE				
8250 Xtra, 8260 Xtra	634DWBAE	30/90-58 (V836855300)			
8260	634DSBIE				
8170, 8180, 8270, 8280	645DSBIE				
8270 Xtra, 8280 Xtra	645DSBAE				







(A) 30/90-13 est inclus dans l'équilibreur monté au milieu, voir page MF-114-115
30/90-13 is included in the mid-mounted balancer units see page MF-114-115

Les références des pièces sont indicatives.
Nos pièces ne sont pas d'origine

Part numbers are quoted for reference purposes only.
Our parts and accessories are not original.



POMPES À HUILE
OIL PUMPS

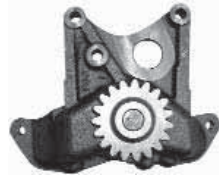



Tracteurs Tractors	Moteur Engine	Pompe à huile Oil pump	Pignon Idler gear	Bague Idler bush	Illustration Illustration
4 Moissonneuses-batteuses moteurs 4 cylindres / 4 cylinder engines combines					
186	A4.212	30/90-3 (41314182, 3637470M91)	30/91-3 (41115085, 3637422M91)	30/84-11 (2511437, 1447752M1)	
8 Plot, 10 Plot, 16 Plot, 16, 99, 187, 206, 240, 307, 330	A4.236				
20, 430, 440, 487, 506	A4.248				
20XP	AT4.236	30/90-55 (4132F012, 3640287M1)			
400 (6929119 ⇒)	A4.300	30/90-12 (41314113, 737964M92)			
6 Moissonneuses-batteuses moteurs 6 cylindres / 6 cylinder engines combines					
500, 507, 510, 515, 520, 525	A6.354	30/90-4 (41314131, 739400M91)			
620, 625, 740, 750	A6.372	30/90-5 (41314067, 736012M91)			
750, 760	AT6.354.1				
24, 27, 530, 530S, 535, 800, 805, 810, 815	A6.354.4	30/90-14 (4132F015, 747292M91)			
750	A6.372.4				
29, 29XP, 31, 31XP, 560, 565, 660, 665, 750, 760, 820, 825, 830, 835, 840, 845, 850, 855, 860	AT6.354.4	30/90-23 (4132F016, 747293M91)			
4 Chargeurs télescopiques / Telescopic handlers					
8925, 8926, 8937, 8939	1004.4 (Blue)	30/90-52 (4132F051, 3640908M91)		30/84-11 (2511437, 1447752M1)	
8925, 8926, 8937, 8939	1004.42 (Green)				
8925T, 8926T, 8937T, 8939T	1004.4T (Blue)	30/90-53 (4132F056, 4222282M91)			
8925T, 8926T, 8937T, 8939T	1004.40T (Green)				

Les références des pièces sont indicatives.
Nos pièces ne sont pas d'origine

Part numbers are quoted for reference purposes only.
Our parts and accessories are not original.

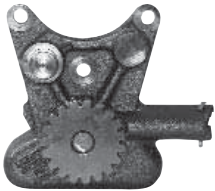

POMPES À HUILE OIL PUMPS

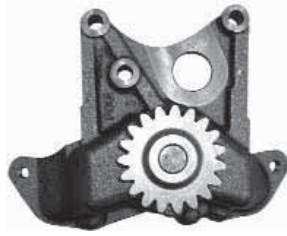
Tracteurs Tractors	Moteur Engine	Pompe à huile Oil pump	Pignon Idler gear	Bague Idler bush	Illustration Illustration
Tracteurs industriels moteurs 3 cylindres / 3 cylinder engine industrial tractors					
203, 205	A3.152	30/90-1 (41314187, 3637359M91)	30/91-1 (41115086, 3637351M91)	30/84-5 (0050265, 731236M1)	
20, 40	AG3.152				
20, 20B, 20C, 20D, 20E, 20F, 30B, 30E, 30H, 40, 203, 205, 2135, 2203, 2205	AD3.152				
40E	AT3.152.4				
Tracteurs industriels moteurs 4 cylindres / 4 cylinder engine industrial tractors					
356	A4.203	30/90-2 (41314189, 3637471M91)	30/91-2 (0994967, 731635M91)		
30, 40B, 50, 302, 304, 356, 3165, 3303, 3305	AD4.203				
50, 50B, 3303, 3305	A4.212	30/90-3 (41314182, 3637470M91)	30/91-3 (41115085, 3637422M91)	30/84-11 (2511437, 1447752M1)	
30D, 50D, 50E, 60 (U880191K ⇔)	A4.236	30/90-13 (A) (4132F041, 3637489M91)			
50EX (LF31164) 50HX, 60H (LF31130, LF31164)	A4.248				
Fermeq & Terex - Tracteurs industriels moteurs 4 cylindres / 4 cylinder engine industrial tractors					
750	1004.4 (Blue)	30/90-52 (4132F051, 3640908M91)		30/84-11 (2511437, 1447752M1)	
750, 750B	1004.42 (Green)				
760, 860, 860S, 860SE, 865, 960, 965	1004.4T (Blue)	30/90-53 (4132F056, 4222282M91)			
760, 760B, 860, 860B, 860S, 860SE, 960, 960B, 965	1004.40T (Green)				

(A) 30/90-13 est inclus dans l'équilibreur monté au milieu, voir page MF-114-115
30/90-13 is included in the mid-mounted balancer units see page MF-114-115

ROTORS DE POMPE À HUILE OIL PUMP ROTOR ASSEMBLY

TEA20, TED20, FE35, 135

30/92-11
(827501M91)



TEF20, FE35

30/92-10
(826059M91)



Les références des pièces sont indicatives.
Nos pièces ne sont pas d'origine

Part numbers are quoted for reference purposes only.
Our parts and accessories are not original.



**EQUILIBREURS MONTES A L'AVANT (FIXATION 4 GOUJONS)
FRONT MOUNTED BALANCER UNIT (4 BOLT FIXING)**

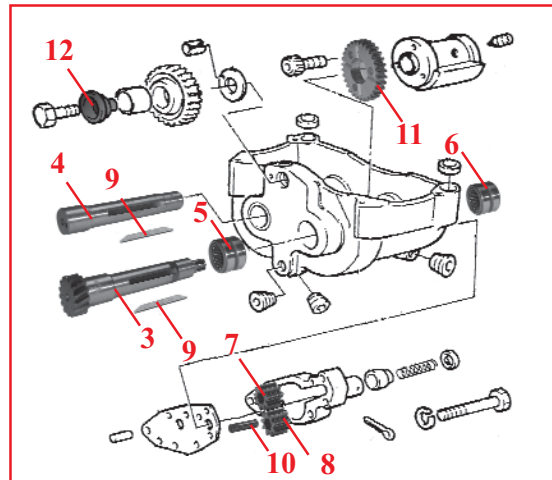
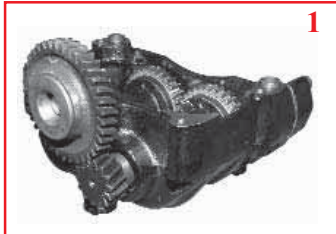

	1	2	3	4	5	6	
Tracteurs Tractors	Moteur Engine	Equilibreur Balancer unit	Jeu rep. Rep. kit	Arbre Drive shaft	Arbre Driven shaft	Bague avt Front bearing	Bague arr Rear bearing
4 Moteurs 4 cylindres / 4 cylinder engines							
165 (France) 174 (212UA170106 ⇒)	A4.212	30/90-6 (41733082, 746432M91)	Petit / Minor 30/92-4 (A) (B1244)	30/93-1 (31171276, 743137M1)	30/93-2 (32731127, 743115M1)	30/89-1 (C) (2558375, 742207M1)	30/89-2 (C) (2558371, 742208M1)
168, 168MKIII, 174, 175, 184, 255 (USA), 265, 273, 274, 275, 283, 284, 565, 575, 675 (⇒ U880190K)	A4.236		Grand / Major 30/92-3 (B) (B1243)			30/89-3 (D) (2557182, 746697M1)	30/89-4 (D) (2557181, 746696M1)
178, 185, 188, 194, 285, 290, 293, 294, 590, 690 (⇒ U880190K)	A4.248						

	7	8	9	10	11	12					
Tracteurs Tractors	Moteur Engine	Pignon Drive gear	Pignon Driven gear	Cale Woodruff key	Axe Dowel pin	Pignon Balancer gear	Couvercle Hub				
4 Moteurs 4 cylindres / 4 cylinder engines											
165 (France) 174 (212UA170106 ⇒)	A4.212	30/94-2 (31165531, 743020M1)	30/94-3 (31165461, 734850M1)	30/94-4 (2576675, 376588X1)	30/94-5 (32455123, 734849M1)	30/94-6 (31164582, 746694M1)	30/99-1 (33451801, 734905M2)				
168, 168MKIII, 174, 175, 184, 255 (USA), 265, 273, 274, 275, 283, 284, 565, 575, 675 (⇒ U880190K)	A4.236										
178, 185, 188, 194, 285, 290, 293, 294, 590, 690 (⇒ U880190K)	A4.248										

- (A) Le jeu 30/92-4 contient une fois les pièces / Contents of 30/92-4 are 1 of each of: 30/93-1, 30/94-2, 30/94-3, 30/94-4 & 30/94-5.
 (B) Le jeu 30/92-3 contient une fois les pièces / Contents of 30/92-3 are 1 of each of: 30/93-1, 30/93-2, 30/94-2, 30/94-3, 30/94-5 & 2x 30/89-3, 2x30/89-4 2x30/94-4.
 (C) 30/89-1 & 30/89-2 sont des roulements à aiguilles lisses pour les premiers équilibres 41733402.
 30/89-1 & 30/89-2 are plain needle bearings for the early balancer unit 41733402.
 (D) 30/89-3 & 30/89-4 sont des roulements à aiguilles dentés pour les derniers équilibres 41733066 & 41733082.
 30/89-3 & 30/89-4 are grooved needle bearings for the later balancer units 41733066 and 41733082.

Les références des pièces sont indicatives.
Nos pièces ne sont pas d'origine

Part numbers are quoted for reference purposes only.
Our parts and accessories are not original.



"THE RELIABLE SERVICE"



**EQUILIBREURS MONTES A L'AVANT (FIXATION 4 GOUJONS)
FRONT MOUNTED BALANCER UNIT (4 BOLT FIXING)**

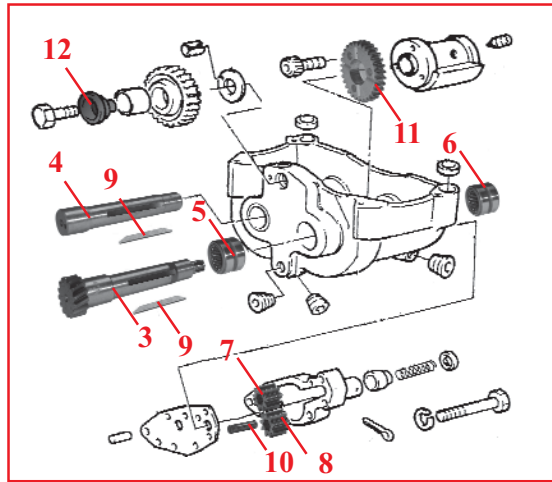
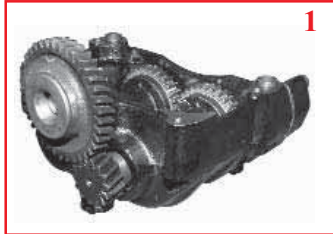

	1	2	3	4	5	6	
Tracteurs Tractors	Moteur Engine	Equilibreur Balancer unit	Jeu rep. Rep. kit	Arbre Drive shaft	Arbre Driven shaft	Bague avt Front bearing	Bague arr Rear bearing
Chargeurs télescopiques / Telescopic handlers							
24	A4.236						
24T	AT4.236						
Tract. industriels moteurs 4 cyl. 4 cyl. engine industrial tractors							
30D, 50D, 50E, 60 (⇒ U880190K)		30/90-6 (41733082, 746432M91)	Petit / Minor 30/92-4 (A) (B1244)	30/93-1 (31171276, 743137M1)	30/93-2 (32731127, 743115M1)	30/89-1 (C) (2558375, 742207M1)	30/89-2 (C) (2558371, 742208M1)
50, 50B, 50B MKII, 50C, 50H, 50H-S, 50H-T	A4.236		Grand / Major 30/92-3 (B) (B1243)				30/89-3 (D) (2557182, 746697M1)
50EX (LF31181) 50HX, 60H (LF31128, LF31135, LF31180)	A4.248						
50HX-S, 50HX-T, 60H-S 60HX, 60HX-T	AT4.236						

	7	8	9	10	11	12	
Tracteurs Tractors	Moteur Engine	Pignon Drive gear	Pignon Driven gear	Cale Woodruff key	Axe Dowel pin	Pignon Balancer gear	Couvercle Hub
Chargeurs télescopiques / Telescopic handlers							
24	A4.236						
24T	AT4.236						
Tract. industriels moteurs 4 cyl. 4 cyl. engine industrial tractors							
30D, 50D, 50E, 60 (⇒ U880190K)		30/94-2 (31165531, 743020M1)	30/94-3 (31165461, 734850M1)	30/94-4 (2576675, 376588X1)	30/94-5 (32455123, 734849M1)	30/94-6 (31164582, 746694M1)	30/99-1 (33451801, 734905M2)
50, 50B, 50B MKII, 50C, 50H, 50H-S, 50H-T	A4.236						
50EX (LF31181) 50HX, 60H (LF31128, LF31135, LF31180)	A4.248						
50HX-S, 50HX-T, 60H-S 60HX, 60HX-T	AT4.236						

(A) Le jeu 30/92-4 contient une fois les pièces / Contents of 30/92-4 are 1 of each of: 30/93-1, 30/94-2, 30/94-3, 30/94-4 & 30/94-5.

(B) Le jeu 30/92-3 contient une fois les pièces / Contents of 30/92-3 are 1 of each of: 30/93-1, 30/93-2, 30/94-2, 30/94-3, 30/94-5 & 2x 30/89-3, 2x30/89-4 2x30/94-4.

(C) 30/89-1 & 30/89-2 sont des roulements à aiguilles lisses pour les premiers équilibreurs 41733402.
30/89-1 & 30/89-2 are plain needle bearings for the early balancer unit 41733402.

(D) 30/89-3 & 30/89-4 sont des roulements à aiguilles dentés pour les derniers équilibreurs 41733066 & 41733082.
30/89-3 & 30/89-4 are grooved needle bearings for the later balancer units 41733066 and 41733082.

Les références des pièces sont indicatives.
Nos pièces ne sont pas d'origine

Part numbers are quoted for reference purposes only.
Our parts and accessories are not original.



"THE RELIABLE SERVICE"



EQUILIBREURS MONTES AU MILIEU (FIXATION 6 GOUJONS)
MID-MOUNTED BALANCER UNIT (6 BOLT FIXING)

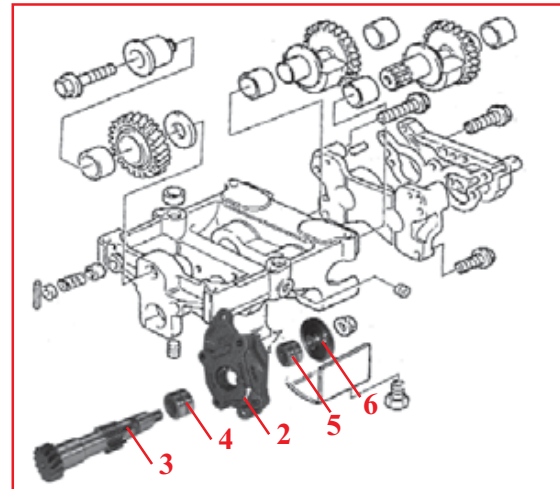
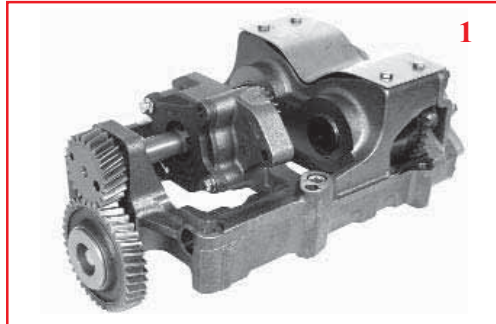

Tracteurs Tractors	Moteur Engine	1 Equilibreur Balancer unit	2 Pompe à huile Oil pump	3 Arbre Drive shaft	4 Bague avt Front bearing	5 Bague arr Rear bearing	6 Pignon Balancer gear
Moteurs 4 cylindres / 4 cylinder engines							
168MKIII, 174, 184, 265, 273, 274, 275, 283, 284, 565, 575, 675 (U880191K ⇒)	A4.236	30/90-15 (4111K064, 4224110M91)					
275E, 367CF, 373, 374, 375E, 376C, 377, 383, 384, 387, 3050, 3220, 3225 362, 362N, 365, 372N, 375 (⇒ U171963P)							
178, 185, 188, 194, 285, 290, 293, 294, 590, 690 (U880191K ⇒)	A4.248						
290E, 390E, 393, 394, 396C, 397, 3055, 3060, 3235							
362, 362N, 365, 372N, 375, (U171964P ⇒)	A4.236	30/90-17 (4111K059, 4224107M91)	30/90-13 (4132F041, 3637489M91)	30/93-10 (3117V003, 3637593M1)	30/89-5 (2551A009, 1447727M91)	30/89-6 (2551A014, 1447723M1)	30/94-11 (3116W001, 746954M1)
382N, 390	A4.248						
393TLX, 394TAQ, 396CT, 397T, 698T, 1004T, 1007, 3065, 3065S, 3070	AT4.236	30/90-16 (4111K066, 4224141M91)					
390T, 398 (⇒ U171963P)							
390T, 398 (U171964P ⇒)	AT4.236	30/90-18 (4111K062, 4224108M91)					
275E, 290E, 375E, 390E	A4.41	30/90-17 (4111K059, 4224107M91)					
4225, 4235, 4240, 6110, 6120	A4.41 (Blue)	30/90-15 (4111K064, 4224110M91)					

Les références des pièces sont indicatives.
Nos pièces ne sont pas d'origine

Part numbers are quoted for reference purposes only.
Our parts and accessories are not original.



EQUILIBREURS MONTES AU MILIEU (FIXATION 6 GOUJONS)
MID-MOUNTED BALANCER UNIT (6 BOLT FIXING)

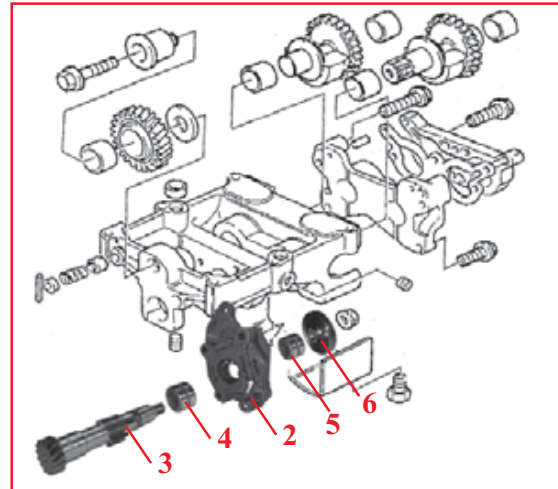
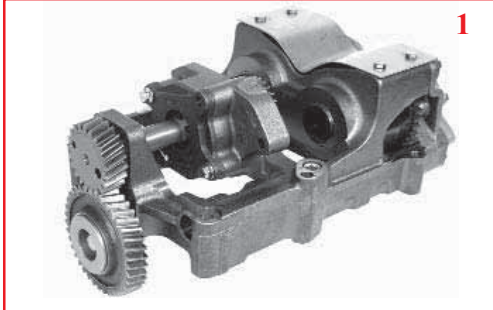

		1	2	3	4	5	6
Tracteurs Tractors	Moteur Engine	Equilibreur Balancer unit	Pompe à huile Oil pump	Arbre Drive shaft	Bague avt Front bearing	Bague arr Rear bearing	Pignon Balancer gear
4 <i>Moteurs 4 cylindres / 4 cylinder engines</i>							
3075, 6130, 6140, 6150	1004.4T	30/90-16 (4111K066, 4224141M91)	30/90-13 (4132F041, 3637489M91)	30/93-10 (3117V003, 3637593M1)	30/89-5 (2551A009, 1447727M91)	30/89-6 (2551A014, 1447723M1)	30/94-11 (3116W001, 746954M1)
4245, 4255	1004.4T (Blue)	30/90-18 (4111K062, 4224108M91)					
374, 3220, 3330	1004.40 (Green)	30/90-16 (4111K066, 4224141M91)					
4225, 4325	1004.40 (Green)	30/90-18 (4111K062, 4224108M91)					
3350, 3355	1004.40T	30/90-16 (4111K066, 4224141M91)					
4235, 4245, 4255, 4345, 4355, 6235, 6245, 6255	1004.40T (Green)	30/90-18 (4111K062, 4224108M91)					
4265, 4365, 6265	1004.40TW (Green)	30/90-18 (4111K062, 4224108M91)					
394, 2230, 3235, 3340	1004.42 (Green)	30/90-15 (4111K064, 4224110M91)					
4235 (USA), 4335	1004.42 (Green)	30/90-17 (4111K059, 4224107M91)					
4 <i>Tract. industriels moteurs 4 cyl. 4 cyl. engine industrial tractors</i>							
30D, 50D, 50E, 60 (U880191K ⇌)	A4.236	30/90-15 (4111K064, 4224110M91)					
50EX (LF31164) 50HX, 60H (LF31130, LF31164)	A4.248						

Les références des pièces sont indicatives.
Nos pièces ne sont pas d'origine

Part numbers are quoted for reference purposes only.
Our parts and accessories are not original.



BOUGIES DE PRECHAUFFAGE
HEATING PLUGS



Tracteurs Tractors	Moteur Engine	Fig.	Réf. Ref.	OEM	Filetage Thread	Type Type
FE35 65, 765	23C A4.192	1	30/60-1	1446176M91, 2666805	1/2 BSP	A vis Screw connector
		2	30/60-22		1/2 BSP	A fiche Plug connector
Moteurs atmosphériques Atmospheric engines A3.152, A4.192, A4.203, A4.212, A4.236, A4.248, A6.354, 1004, 1006, 620, 634, 645		1	30/60-2	2666103, 893501M1	7/8 UNF	A vis Screw connector
		2	30/60-3	2666108, 3583543M2	7/8 UNF	A fiche Plug connector
Moteurs turbo Turbo engines		2	30/60-23	1854125M1	7/8 UNF	A fiche Plug connector
Réservoir auxiliaire / Auxiliary tank						
FE35, 37, 65, 133, 135, 140, 145, 148, 152, 165, 175, 178, 230, 240, 245, 250, 765, 1200, 1250 Industriels / Industrial 50, 50B, 50E		3	30/61-3	37721551, 891969M91	3/8 UNF	

RACCORDS POUR BOUGIES & RESERVOIR AUXILIAIRE
PIPE FITTINGS & AUX. TANK COUPLINGS

3/8" x 24 UNF			Tuyau / Pipe
	69/9198-11 69/9198-15 69/9198-33	21mm 14.4mm 18mm	69/9197-2 Ø 4.76mm - 3/16" Vendu au mètre / Sold by meter
	69/9198-13 69/9198-16	17.5mm 16mm	
	69/9198-23	33.2mm	
	69/9198-24	28mm	

Les références des pièces sont indicatives.
Nos pièces ne sont pas d'origine

Part numbers are quoted for reference purposes only.
Our parts and accessories are not original.



POMPES D'ALIMENTATION
FUEL PUMPS

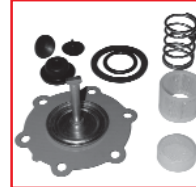
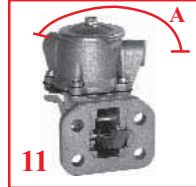
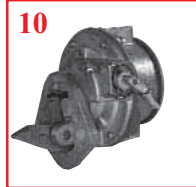
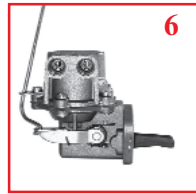
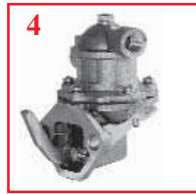
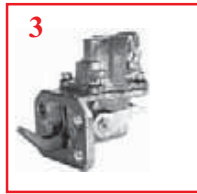
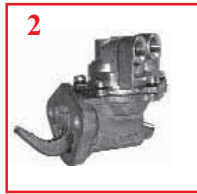

Tracteurs Tractors	Moteur Engine	Fig.	Réf. Ref.	OEM	Remarque Observation	Jeu de réparation Repair kit
3 Moteurs 3 cylindres / 3 cylinder engines						
35, 133, 135 35 133, 135, 140, 145, 148, 150, 152, 154	A3.144 A3.152 AD3.152	1	30/100-3	4222094M91 ULPK0018	2 trous / holes Bol décanteur Glass bowl	30/101-3 (4222118M91, ULPR0006)
133, 135 35 133, 134, 135, 140, 145, 148, 150, 152, 154, 230, 233, 234, 235, 240, 245, 250, 253 (Italy), 254, 255, 550	A3.144 A3.152 AD3.152	2	30/100-4	4222111M91 ULPK0006	2 trous / holes	30/101-4 (4222109M91, ULPR0003)
133, 134, 135, 145, 152, 154, 230, 233, 234, 240, 244CF, 250, 253 (Italy), 254, 255, 333, 334V, 340, 342, 350, 353, 354, 356CF, 2205, 3210	AD3.152	3	30/100-19	4222090M91 ULPK0004	4 trous / holes	30/101-10 (4222125M91, ULPR0005)
164T, 253 (UK), 263T (Italy), 264T, 352, 355, 360, 363, 364, 366CF	AT3.152.4					
2210, 3315, 4215, 4315	903.27					
263 (UK), 2220, 3325, 4220, 4320	903.27T					
4 Moteurs 4 cylindres / 4 cylinder engines						
TEF20	20C Diesel	4	30/100-1	826154M91	2 trous / holes	30/101-4 (4222109M91, ULPR0003)
FE35 (⇒ SJ37180E)	23C Diesel					
FE35 (SJ37181E ⇒), 835	23C Diesel	5	30/100-2	1884857M91	2 trous / holes	
25, 30, 130, 825	A4.107	6	30/100-17	4222174M91 ULPK0017	2 trous / holes	30/101-4 (4222109M91, ULPR0003)
65	A4.192	7	30/100-5	4222452M91 ULPK0009	Bol décanteur Glass bowl	30/101-5 (4222110M91, ULPR0004)
65, 865	A4.203					
65, 155, 158, 165, 765	AD4.203					
65, 155, 158, 165, 765	AD4.203	8	30/100-6	4222107M91 ULPK0010	2 trous / holes	
158MKIII, 260, 560	AD4.203	9	30/100-71	4222121M91 ULPK0008	4 trous / holes	30/101-10 (4222125M91, ULPR0005)
165, 174	A4.212	10	30/100-7	4222104M91 ULPK0011	2 trous / holes	30/101-7 (1883344M92, 26410050)
168, 175	A4.236					
168, 174, 175, 184, 265, 273, 274, 275, 275E, 283, 284, 362, 362N, 365, 367CF, 372N, 373, 374, 375, 375E, 376C, 383, 384, 565, 575, 675, 3050, 3220, 3225	A4.236	11	30/100-10 A=200°	4222108M91 ULPK0001	4 trous / holes	30/101-10 (4222125M91, ULPR0005)
165, 168, 174, 175, 178, 184, 265, 273, 274, 275, 284, 373, 374, 377, 383, 384, 387, 393, 565, 575	A4.236					

'A' est l'angle entre l'arrivée et la sortie. / 'A' is the angle between the inlet and outlet pipe.

Les références des pièces sont indicatives.
Nos pièces ne sont pas d'origine

Part numbers are quoted for reference purposes only.
Our parts and accessories are not original.



POMPES D'ALIMENTATION
FUEL PUMPS

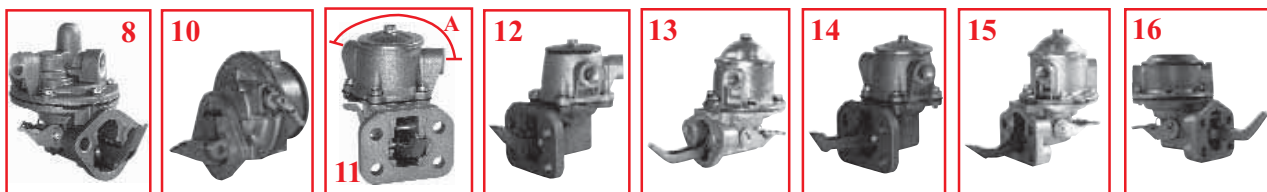

Tracteurs Tractors	Moteur Engine	Fig.	Réf. Ref.	OEM	Remarque Observation	Jeu de réparation Repair kit					
4 Moteurs 4 cylindres / 4 cylinder engines											
390T, 398, 698T, 1004T, 3065, 3065S, 3070	AT4.236	11	30/100-10 A=200°	4222108M91 ULPK0001	4 trous / holes	30/101-10 (4222125M91, ULPR0005)					
393TLX, 394TAQ, 396CT, 397T, 1007	AT4.236		30/100-8 A=140°	4222091M91 ULPK0003	4 trous / holes						
178, 185, 188	A4.248	10	30/100-7	4222104M91 ULPK0011	2 trous / holes	30/101-7 (1883344M92, 26410050)					
185, 188, 194, 285, 290, 294, 393, 394, 396C, 397, 590	A4.248	11	30/100-8 A=140°	4222091M91 ULPK0007	4 trous / holes	30/101-10 (4222125M91, ULPR0005)					
194, 290, 290E, 293, 294, 382N, 390, 390E, 690, 3055, 3060	A4.248		30/100-10 A=200°	4222108M91 ULPK0001	4 trous / holes						
285 (USA), 298, 592, 595, 698, 1004, 1080, 1085	A4.318	8	30/100-6	4222107M91 ULPK0010	2 trous / holes	30/101-5 (4222110M91, ULPR0004)					
4225, 4235, 4240, 6110, 6120	A4.41 (Blue)	12	30/100-32	4224451M91 ULPK0034	4 trous / holes	30/101-10 (4222125M91, ULPR0005)					
275E, 290E, 375E, 390E	A4.41 (Blue)	11	30/100-10 A=200°	4222108M91 ULPK0001	4 trous / holes						
374, 3220, 3330, 4225, 4325	1004.40 (Green)	12	30/100-32	4224451M91 ULPK0034	4 trous / holes						
394, 2230, 3235, 3340, 4235 (USA), 4335	1004.42 (Green)										
3075, 4245, 4255, 6130, 6140, 6150	1004.4T (Blue)										
3350, 3355, 4235, 4245, 4255, 4345, 4355, 6235, 6245, 6255	1004.40T (Green)										
4265, 4365, 6265	1004.40TW										
6 Moteurs 6 cylindres / 6 cylinder engines											
1014, 1104, 1200	A6.354.1						13	30/100-9	4222093M91 ULPK0007	2 trous / holes	30/101-5 (4222110M91, ULPR0004)
1105, 1135	AT6.354.1										
1114 (⇒ U711699L)	A6.354.4					14	30/100-72	4223583M91 ULPK0022	4 trous / holes		
399, 699, 1014, 1024 1114 (U711700L ⇒) 1250, 2620, 2625, 2640, 2645, 2675, 3080, 3090, 3610	A6.354.4	15	30/100-25	4222105M91 ULPK0002	4 trous / holes	30/101-31 (4222119M91, ULPR0002)					
1134, 2680, 2685, 2705, 2720, 2725, 3630, 3650	AT6.354.4										
396, 399, 3085, 3095, 3115, 4260, 4270, 6160, 6170	1006.6 (Blue)										
3120, 3120T, 3125, 3140, 3635, 3645, 3660, 6180, 6190, 8110, 8120, 8130	1006.6T (Blue)										
4260, 4360, 6260	1006.60 (Green)										
6170, 6180, 6270, 6280, 6290, 8120, 8220	1006.60T (Green)										
4270, 4370	1006.60T (Green)						16	30/100-44	4222449M91 ULPK0015	4 trous / holes	

'A' est l'angle entre l'arrivée et la sortie. / 'A' is the angle between the inlet and outlet pipe.

Les références des pièces sont indicatives.
Nos pièces ne sont pas d'origine

Part numbers are quoted for reference purposes only.
Our parts and accessories are not original.



POMPES D'ALIMENTATION
FUEL PUMPS

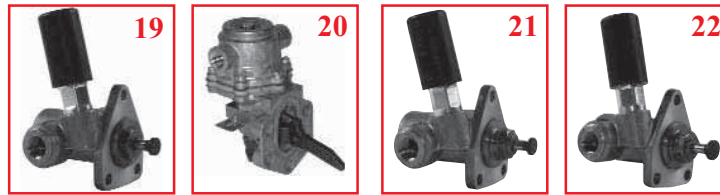

Tracteurs Tractors	Moteur Engine	Fig.	Réf. Ref.	OEM	Remarque Observation
6 Moteurs 6 cylindres / 6 cylinder engines					
3680, 3690 3670, 8140, 8150	612DS 620DS	19	30/100-82	3637646M91 V835340017	Pompe mécanique <i>Mechanical pump</i>
8140 (H07868 ⇒) 8240	620DS 620DSRAE	20	30/100-83	V836659580	Pompe à membrane <i>Diaphragm pump</i> 5 trous / 5 holes
8240Xtra	620DWBAE	21	30/100-84	V836340066	Pompe mécanique <i>Mechanical pump</i>
3690, 8160	634DS	19	30/100-82	3637646M91 V835340017	Pompe mécanique <i>Mechanical pump</i>
8250, 8260	634DSBAE	21	30/100-84	V836340066	Pompe mécanique <i>Mechanical pump</i>
8250Xtra, 8260Xtra	634DWBAE	22	30/100-85	V836362023	Pompe mécanique <i>Mechanical pump</i>
8170, 8180, 8270, 8280 8270Xtra, 8280Xtra	645DSBIE 645DSBAE	21	30/100-84	V836340066	Pompe mécanique <i>Mechanical pump</i>

PIECES DE RECHANGE / SPARE PARTS

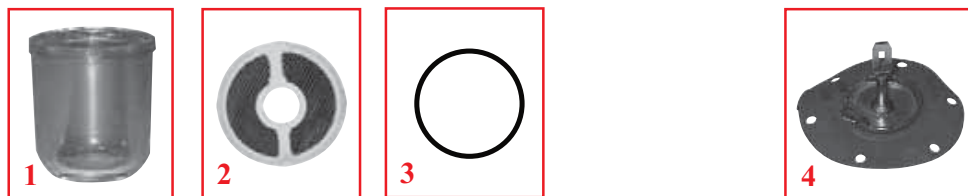

	1	2	3		4
Pompe Pump	Bol décanteur Glass bowl	Tamis Strainer	Joint Gasket	Pompe Pump	Membranes Diaphragm
30/100-3	30/102-1 (1004498M1)	30/101-57 (1850160M1)	30/101-58 (1655042M91)	Tous types <i>All models</i>	30/101-43M (26410089)
30/100-5					

Les références des pièces sont indicatives.
Nos pièces ne sont pas d'origine

Part numbers are quoted for reference purposes only.
Our parts and accessories are not original.



**POMPES D'ALIMENTATION
FUEL PUMPS**

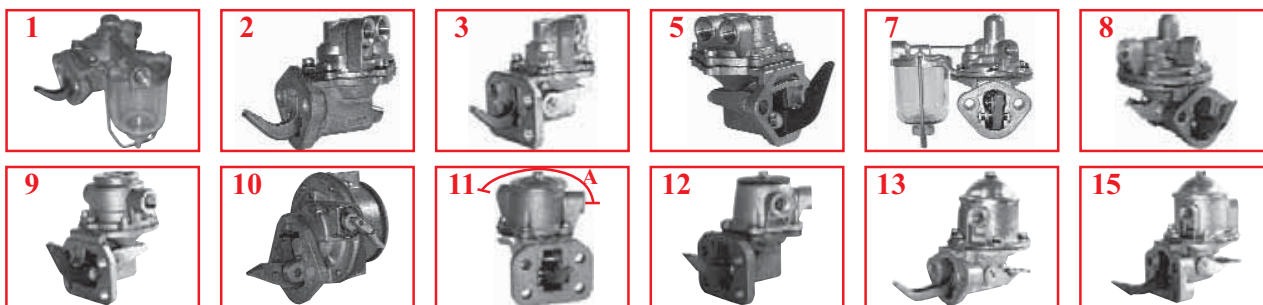

Tracteurs Tractors	Moteur Engine	Fig.	Réf. Ref.	OEM	Remarque Observation	Jeu de réparation Repair kit
4 Moissonneuses-batteuses moteurs 4 cylindres / 4 cylinder engines combines						
186	A4.212	10	30/100-7	4222104M91 ULPK0011	2 trous / holes	30/101-7 (1883344M92, 26410050)
99, 187	A4.236					
487, 506	A4.248					
8Plot, 10Plot, 16, 16Plot, 240, 307, 330	A4.236	11	30/100-10 A=200°	4222108M91 ULPK0001	4 trous / holes	30/101-10 (4222125M91, ULPR0005)
20, 430, 440, 487, 506	A4.248					
20XP	AT4.236					
400, 410	A4.300	7	30/100-5	4222452M91 ULPK0009	Bol décanteur Glass bowl	30/101-5 (4222110M91, ULPR0004)
6 Moissonneuses-batteuses moteurs 6 cylindres / 6 cylinder engines combines						
500, 507, 510, 515, 520, 525	A6.354	13	30/100-9	4222093M91 ULPK0007	2 trous / holes	30/101-5 (4222110M91, ULPR0004)
24, 530, 530S, 535, 800, 805, 810, 815	A6.354.4	15	30/100-25	4222105M91 ULPK0002	4 trous / holes	30/101-31 (422219M91, ULPR0002)
27, 29, 29XP, 31, 31XP, 560, 565, 660, 665, 820, 825, 830, 835, 840, 845, 850, 855, 865	AT6.354.4					
750, 760	AT6.354.4					
620, 625, 740, 750	A6.372	13	30/100-9	4222093M91 ULPK0007	2 trous / holes	30/101-5 (4222110M91, ULPR0004)
4 Chargeurs télescopiques / Telescopic handlers						
8925, 8925T, 8926, 8926T, 8937, 8937T, 8939, 8939T	1004.4 (Blue) 1004.42 (Green) 1004.4T (Blue) 1004.40T (Green)	12	30/100-32	4222106M91 ULPK0005	4 trous / holes	30/101-10 (4222125M91, ULPR0005)
4 Tracteurs industriels moteurs 4 cylindres / 4 cylinder engine industrial tractors						
203, 205	A3.152	1	30/100-3	4222094M91 ULPK0018	2 trous / holes	30/101-3 (4222118M91, ULPR0006)
20, 30B, 203, 205, 2135, 2203, 2205	AD3.152					
20, 20B, 20C, 20D, 20E, 30B, 30H, 203, 205, 2135, 2203, 2205	AD3.152	2	30/100-4	4222111M91 ULPK0006	2 trous / holes	30/101-4 (4222109M91, ULPR0003)
20B/C/D/E/F, 30B/E/H, 40	AD3.152	3	30/100-19	4222090M91 ULPK0004	4 trous / holes	30/101-10 (4222125M91, ULPR0005)
40E	AT3.152.4					
702	23C	5	30/100-2	1884857M91	2 trous / holes	
356	A4.203	7	30/100-5	4222452M91 ULPK0009	Bol décanteur Glass bowl	30/101-5 (4222110M91, ULPR0004)
30, 50, 302, 304, 356, 3165, 3303, 3305	AD4.203					
40B, 50, 302, 304, 356 3165, 3303, 3305	AD4.203					
70	A4.318	8	30/100-6	4222107M91 ULPK0010	2 trous / holes	
40B	AD4.203	9	30/100-71	4222121M91 ULPK0008	4 trous / holes	30/101-10 (4222125M91, ULPR0005)
50, 50B 3303, 3305	A4.212	10	30/100-7	4222104M91 ULPK0011	2 trous / holes	30/101-7 (1883344M92, 26410050)
50C	A4.236					
50, 50B	A4.212	11	30/100-8 A=140°	4222091M91 ULPK0003	4 trous / holes	30/101-10 (4222125M91, ULPR0005)
50, 50B, 50B Mk11, 50C	A4.236					
30D, 50D, 50E, 50H, 50H-S, 50H-T, 60 60HX, 60HX-T	A4.236	11	30/100-10 A=200°	4222108M91 ULPK0001	4 trous / holes	
50EX/HX/HX-S/HX-T, 60H/H-S	AT4.236 A4.248					
4 Fermec & Terex - Tracteurs industriels moteurs 4 cylindres / 4 cylinder engine industrial tractors						
750, 760, 860, 960, 965	1004.4 (Blue) 1004.4T (Blue)	12	30/100-32	4222106M91 ULPK0005	4 trous / holes	30/101-10 (4222125M91, ULPR0005)

'A' est l'angle entre l'arrivée et la sortie. / 'A' is the angle between the inlet and outlet pipe.

Les références des pièces sont indicatives.
Nos pièces ne sont pas d'origine

Part numbers are quoted for reference purposes only.
Our parts and accessories are not original.



"THE RELIABLE SERVICE"



**RESERVOIRS & ACCESSOIRES
FUEL TANKS AND RELATED PARTS**

Réservoirs / Tanks

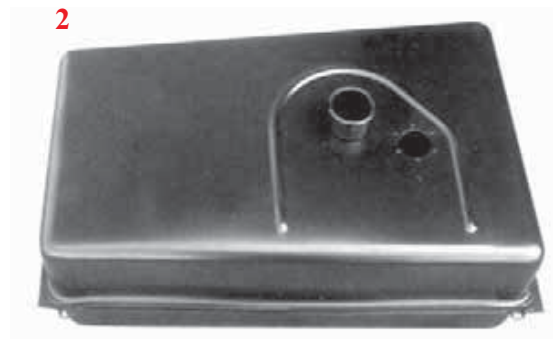
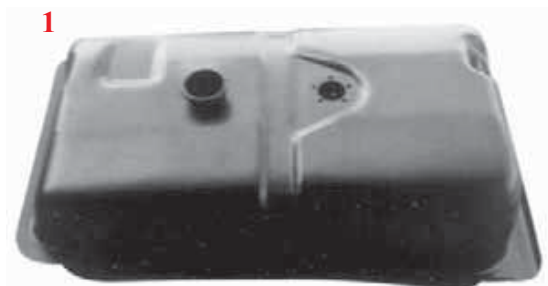

Tracteurs Tractors	Fig.	Réf. Ref.	OEM
135 <i>Dimension standard / Standard size</i>	1	30/6099-6	897401M92
230, 240, 243, 250, 253, 263		30/6099-7	3762589M91
275, 275E, 285, 290, 290E, 375E, 390E	2	30/6099-8	3762587M91, 532300M94

**AMORTISSEUR DE RESERVOIR
TANK DAMPER**



30/106-2
(883623M1)

165, 168, 175, 178, 185, 188, 265, 275, 285,
290, 298, 375E, 390E

Les références des pièces sont indicatives.
Nos pièces ne sont pas d'origine

Part numbers are quoted for reference purposes only.
Our parts and accessories are not original.



**RESERVOIRS & ACCESSOIRES
FUEL TANKS AND RELATED PARTS**

Bouchons / Caps

Tracteurs Tractors	Fig.	Réf. Ref.	OEM
25, 35, 35X, 65, 133, 135, 140, 145, 148, 152, 158, 165, 175, 185, 188, 230, 235, 240, 245, 250, 253, 255, 260, 263, 265, 275, 285, 290, 298, 550, 560, 575, 590, 592, 595, 675, 690, 698, 699, 765, 825, 835, 865, 1004	1	30/105-1 <i>Economique Economy</i> 30/105-2	828583M91 1876534M91
340, 342, 350, 352, 355, 360, 362, 365, 372N, 375, 382N, 390, 396, 398, 399	2	30/105-6	1695732M1
2620, 2625, 2640, 2645, 2680, 2685, 2720, 2725, 3050, 3060, 3065, 3070, 3075, 3080, 3085, 3090, 3095, 3115, 3120, 3125, 3610, 3630, 3635, 3645, 3650, 3655, 3670, 3680, 3690, 6110, 6120, 6130, 6140, 6150, 6160, 6170, 6180, 6190, 6235, 6245, 6255, 6260, 6265, 6270, 6280, 6290, 8110, 8120, 8130, 8140, 8150, 8160	3	30/105-7	3041489M4
134, 154, 174, 184, 194, 234S	4	30/105-19	1825066M92
154S, 174S, 184S, 234, 254, 274, 284, 294, 364, 1014, 1024	5	30/105-20	3300019M91



Robinets / Taps

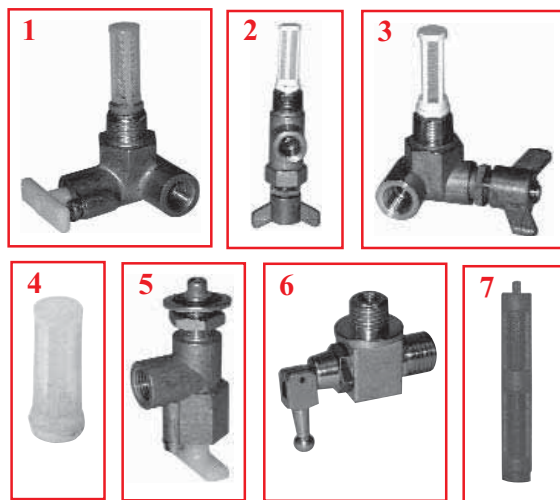

Tracteurs Tractors	Fig.	Réf. Ref.	OEM
35, 35X, 65, 133, 134, 135, 140, 145, 148, 152, 155, 158, 165, 235, 245, 250, 255, 260, 765, 2620, 2625, 2640, 2645, 2680, 2685, 2720, 2725	1	30/103-1	1851653M91
133, 135, 140, 148, 230, 231, 235, 240, 245, 250, 255, 260, 261, 1200, 1250	2	30/103-2	898540M91
165, 168, 175, 178, 185, 188, 265, 275, 285, 290, 298	3	30/103-3	898580M91
Filtre séparé pour / <i>Separate filter for</i> : 30/103-1, 30/103-2, 30/103-3	4	30/104-1	1851654M1
230, 240, 253, 263, 265, 275, 290, 340, 342, 350, 352, 355, 360, 362, 365, 372N, 375, 382N, 390, 398	5	30/103-4	1694985M92
134, 154, 174, 184, 194, 233, 234, 253, 254, 263, 264, 273, 274, 284, 293, 294	6	30/103-14	3302134M91
Filtre séparé pour / <i>Separate filter for</i> :30/103-14	7	30/104-3	3310087M1

**CLIPS DE COMMANDE DE GAZ
THROTTLE CLIPS**

30/6687-1
(894224M1)

Ø 6mm

30/6687-2
(894225M1)

Ø 5mm



Les références des pièces sont indicatives.
Nos pièces ne sont pas d'origine







*Part numbers are quoted for reference purposes only.
Our parts and accessories are not original.*



CABLES D'ARRÊTS STOP CABLES

Tracteurs Tractors	Réf. Ref.	OEM	Longueur A Length A
			
230, 240, 253 350, 355, 360, 4225, 4235, 4240, 4245, 4255 (Marche pied / Footstep)	30/107-3	3701712M91	1010mm
340, 350, 355, 360 (Avec cabine / With cab) - 362, 362N, 382N (Marche pied / Footstep) 365, 375, 390, 390T, 398, 399	30/107-4	3701713M91	1160mm
342, 352, 365, 372N, 375, 390, 390T, 398, 399 362, 362N, 382N, 4225, 4235, 4240, 4245, 4255 (Avec cabine / With cab)	30/107-5	3701714M93	1300mm
Câble à recouper / Cable to cut	30/107-22		1700mm
	30/107-23		4000mm

CABLES D'ACCELERATEURS THROTTLE CABLES







Tracteurs Tractors	Réf. Ref.	OEM	Longueur A Length A
<i>Câbles à main / Hand cables</i>			
			
240, 243, 253, 263	30/108-26	3759020M92	752 mm
340, 350, 355, 360, 362, 362N, 365, 375, 382N, 390, 390T, 398 (Tracteurs marche-pied / Footstep tractors)	30/108-1	3759021M91	1127 mm
340, 342, 350, 352, 355, 360, 362, 362N, 372N, 382N avec cabine / with cab	30/108-2	3759022M91	1227 mm
365, 375, 390, 390T, 398 avec cabine / with cab 396, 399	30/108-3	3759023M91	1337 mm
			
3050, 3060, 3065, 3070, 3080, 3090, 3610, 3630, 3650 (⇒ N271003)	30/108-32	3388256M3	535 mm
			
3050, 3060, 3065, 3070, 3080, 3090, 3610, 3630, 3650 (N271004 ⇒ R094049) 3680 (⇒ R07520)	30/108-33	3581876M3	865 mm
3050, 3060, 3065, 3070, 3080, 3090, 3610, 3630, 3650 (R094050 ⇒ S157040) 3095, 3115, 3125, 3140, 3645, 3655 (⇒ S157040) 3680 (R07521 ⇒ S157040)	30/108-34	3615017M1	1970 mm
			
3050, 3060, 3065, 3070, 3080, 3090, 3095, 3115, 3125, 3140, 3610, 3630, 3645, 3650, 3655, 3680 (S157041 ⇒) 3075, 3085, 3120, 3120T, 3635, 3670, 3690	30/108-35	3615918M1	720 mm
			
4225, 4235, 4240, 4245, 4255, 4260, 4265, 4270 (K37009 ⇒) 4315, 4320, 4325, 4335, 4345, 4355 avec cabine / with cab	30/108-20	3821313M91	936 mm
			
4235, 4245, 4255, 4265, 4270, 4335, 4345, 4355, 4365, 4370 Avec cabine Versacab / With Versacab cab	30/108-25	3815726M91	820 mm

Les références des pièces sont indicatives.
Nos pièces ne sont pas d'origine

Part numbers are quoted for reference purposes only.
Our parts and accessories are not original.



CABLES D'ACCELERATEURS
THROTTLE CABLES







Tracteurs Tractors	Réf. Ref.	OEM	Longueur A Length A
Câbles à main / Hand cables			
			
6110, 6120, 6130, 6140, 6150, 6160, 6170, 6180, 6190, 8110, 8120, 8130, 8140, 8150, 8160 6160, 6170, 6180, 6190 Plate-forme / Platform (⇒ F336031)	30/108-36	3713027M2	810 mm
			
6160, 6170, 6180, 6190 Plate-forme / Platform (F336032 ⇒) 6260, 6270, 6280, 6290, 8110, 8120, 8130, 8150, 8160 Plate-forme / Platform, 8170, 8180 6235, 6245, 6255, 6260, 6265, 6270, 6280, 6290, 8210, 8220, 8240, 8250, 8260, 8270, 8280 (⇒ 07/01/2001)	30/108-37	3778639M1	855 mm
			
6235, 6245, 6255, 6260, 6265, 6270, 6280, 6290, 8210, 8220, 8240, 8250, 8260, 8270, 8280 (08/01/2001 ⇒)	30/108-38	3785334M1	1270 mm
Câbles au pied / Foot cables			
			
340, 342, 350, 352, 355, 360, 362, 362N, 372N, 382N, 396, 398, 399 (Tracteurs marche-pied / Footstep tractors)	30/108-5	3759025M91	1057 mm
362N, 372N (Cabine Hop - Allemagne / Hop cab - Germany) 365, 375, 390, 390T 396, 398, 399 (Avec cabine / With cab)	30/108-4	3759024M91	977 mm
			
240, 243, 253, 263	30/108-18	3759026M91	1193mm
4215, 4220, 4225, 4235, 4240, 4245, 4255, 4265, 4315, 4320, 4325, 4335, 4345, 4365	30/108-21	3805472M91	1245mm
4260, 4270 (Moteurs Blue engines) 4360, 4370 (Tracteurs marche-pied / Footstep tractors)	30/108-22	3806378M92	1530mm
4260, 4270 (Moteurs Green engines) 4360, 4370 (Avec cabine / With cab)	30/108-23	3811818M91	1560mm
			
3050, 3060, 3065, 3070 (N271004 ⇒ S157040) 3080, 3090, 3610, 3630, 3650 (⇒ S157040) 3095, 3115, 3125, 3140, 3645, 3655, 3680 (⇒ S157040)	30/108-39	3581879M2	205 mm
			
3050, 3060, 3065, 3070 (S157041 ⇒)	30/108-40	3615921M3	710 mm
3075	30/108-41	3619656M2	835 mm
3075, 3085, 3120, 3120T 3095, 3115, 3125, 3140 (S157041 ⇒) 3635 (⇒ B068030) - 3645 (S157041 ⇒ B049014) - 3655 (S157041 ⇒ B062029) 3680 (S157041 ⇒ A084025) - 3670, 3690 (⇒ A084025)	30/108-42	3615919M3	1035 mm
3080, 3090, 3610, 3630, 3650 (S157041 ⇒) - 3670, 3680, 3690 (A084026 ⇒)	30/108-43	3616931M4	1605 mm

Les références des pièces sont indicatives.
Nos pièces ne sont pas d'origine

Part numbers are quoted for reference purposes only.
Our parts and accessories are not original.



**CABLES D'ACCELERATEURS
THROTTLE CABLES**

Tracteurs Tractors	Réf. Ref.	OEM	Longueur A Length A
Câbles au pied / Foot cables			
			
3120, 3120T 3635 (B068031 ⇨) - 3645 (B049015 ⇨) - 3655 (B062030 ⇨)	30/108-44	3619105M2	1085 mm
6110, 6120, 6130, 6140	30/108-45	3619375M3	615 mm
6160, 8150, 8160 6170 (⇨ F014037)	30/108-46	3713022M2	895 mm
6180 (⇨ F017008) - 8120 (⇨ F044008) - 8270 (⇨ J116025) - 8280 (⇨ J083023) 6190, 8110, 8130, 8170, 8180, 8210, 8220	30/108-47	3713025M6	955 mm
6170 (F014038 ⇨) - 6180 (F017009 ⇨) - 8120 (F044009 ⇨) 6260, 6270, 6280, 6290	30/108-48	3715973M1	890 mm
8140, 8240	30/108-49	3713440M2	1235 mm
8250, 8260, 8270 (J116026 ⇨) - 8280 (J083024 ⇨)	30/108-42	3615919M3	1035 mm
			
3050, 3060, 3065, 3070 (⇨ N271003)	30/108-50	3386146M3	1410 mm
3050, 3060, 3065, 3070, 3080, 3090, 3095, 3115, 3125, 3645 (S157041 ⇨) 3085, 3655 <i>Avec cabine forestière / With forestry cab</i>	30/108-51	3616474M1	1320 mm
6150	30/108-52	3713026M2	675 mm
			
6235, 6245, 6255, 6265	30/108-53	3782749M1	685 mm
Câbles central / Centre cables			
			
240, 243, 253, 263, 340, 342, 350, 352, 355, 360	30/108-7	1696818M94	210 mm
362, 362N, 372N, 382N (C10425 ⇨)	30/108-16	3761360M91	220 mm
365, 375, 390, 390T, 398, 399 (1006.6) (⇨ C10424)	30/108-8	1696819M94	280 mm
365, 375, 390, 390T, 398, 399 (1006.6) (C10425 ⇨)	30/108-15	3761359M91	235 mm
396, 398, 399 (1006.6) (C10425 ⇨)	30/108-17	3761361M91	420 mm
399 (A6.354.4)	30/108-9	1696816M97	627 mm
			
3050, 3060, 3065, 3070 (N271004 ⇨ S157040)	30/108-54	3581877M2	1905 mm
3080, 3090, 3610, 3630, 3650 (⇨ S157040)	30/108-55	3581878M3	2310 mm
3095, 3115, 3125, 3140, 3645, 3655, 3680 (⇨ S157040)	30/108-56	3583363M1	2055 mm
Câbles à main arrière / Rear control - hand cable			
			
4215, 4220 4225, 4235, 4240, 4245, 4255, 4260, 4265, 4270 (⇨ K37008) <i>Avec console de cabine latérale / With cab-side console</i>	30/108-19	3805131M91	976mm
4225, 4235, 4240, 4245, 4255, 4260, 4265, 4270, 4315, 4320, 4325, 4335, 4345, 4355, 4360, 4370 <i>Tracteurs marche-pied / Footstep tractors - Centre shift and side console</i>	30/108-24	3813027M91	700mm

Les références des pièces sont indicatives.
Nos pièces ne sont pas d'origine

Part numbers are quoted for reference purposes only.
Our parts and accessories are not original.



NEZ D'INJECTEUR INJECTOR NOZZLES

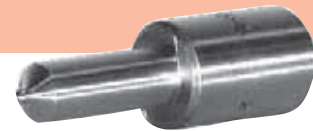
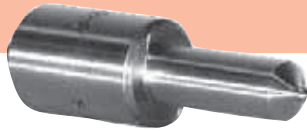

Tracteurs Tractors	Moteur Engine	Réf. Ref.	N° du nez Nozzle N°	OEM
3 Moteurs 3 cylindres / 3 cylinder engines				
35, 133, 135	A3.144	30/117-3	BDLL110S6133	31990, 1851744M1 2646607, 1447252M1
35	A3.152			
135 (⇒ 203993D)	AD3.152	30/117-4	BDLL150S6372	2646676, 1853019M91
135 (203994D ⇒), 230, 233, 240, 333, 334V, 340	AD3.152	30/117-34	BDLL150S6743	2646848, 1447474M1
134, 135(Export), 140, 234, 235, 245	AD3.152	30/117-96	BDLL150S6554	2646688, 1446701M1
145, 148, 152, 154, 233, 244CF, 250, 253 (Italy), 254, 255, 342, 350, 353, 354, 550, 2205, 3210	AD3.152	30/117-35	BDLL150S6602	2646825, 1446896M1, 2645L604, 4222905M1
253(UK), 352, 355, 360, 363, 364, 366CF	AT3.152.4	30/117-36	JB6801029	2645K603, 3637320M1
2210, 3315, 4215, 4315	903-27	30/117-161	L058PBA	2645A633, 4224323M1
263(UK), 2220, 3325, 4220, 4320	903-27T	30/117-149	L068PBA	2645A637, 4222733M1
4 Moteurs 4 cylindres / 4 cylinder engines				
FE35, 835	23C	30/117-12	BDN12SPC6290 5651241	890007M2
25, 30, 130, 825	A4.107	30/117-31	BDN4SD6769	2646724, 1447768M1
65, 865	A4.203	30/117-3	BDL110S6133	31990, 1851744M1
65, 165(UK), 765	AD4.203	30/117-4	BDLL150S6372	2646676, 1853019M91
155, 158, 165(France)	AD4.203	30/117-96	BDLL150S6554	2646688, 1446701M1
260, 560	AD4.203	30/117-34	BDLL150S6743	2646848, 1447474M1
165, 174	A4.212	30/117-6	BDLL150S6555	2646689, 1446702M1
168, 174, 175, 184, 265, 273, 274, 275, 275E, 283, 284, 362, 362N, 365, 367CF, 372N, 373, 374, 375, 375E, 376C, 377, 383, 384, 387, 565, 575, 675, 3050, 3220, 3225	A4.236	30/117-9	BDLL150S6705	2646842, 1447227M1
390T, 393TLX, 394TAQ, 396CT, 397T, 398, 698T, 1004T, 1007, 3065, 3070	AT4.236	30/117-37	JB6801027	3637319M1, 2645K602
178, 185, 188, 194, 284, 285, 293, 294	A4.248	30/117-8	BDLL150S6556	2646690, 1446703M1
290, 290E, 382N, 390, 390E, 393, 394, 396, 397, 590, 690, 3055, 3060, 3235	A4.248	30/117-10	BDLL150S6600	2646826, 1447146M1
298, 592, 595, 698, 1004, 1080, 1085	A4.318	30/117-32	BDLL150S6599	2646824, 1446892M1
275E, 290E, 375E, 390E, 4240, 6120	A4.41	30/117-42	JB6801022	2645A604, 1447829M91
4225, 4235 (⇒ 01/01/99), 6110	A4.41	30/117-37	JB6801027	3637319M1, 2645K602
4235 (02/01/99 ⇒)	A4.41	30/117-135	6801058 JVM	2645A608, 3637195M1
374, 3220, 3330, 4225, 4235	1004.40 (Green)	30/117-154	L064PBA	2645A627, 4222292M1
394, 2230, 3235, 3340, 4235, 4335	1004.42 (Green)	30/117-146	L072PBA BVM	2645K609, 4222977M1
4245, 6130	1004.4T (Blue)	30/117-155	6801088	2645A613, 3640923M1
3075, 4255, 6140, 6150	1004.4T (Blue)	30/117-136	6801157	2645A621, 3640961M1
3350, 3355, 4235, 4245, 4345, 6235, 6245	1004.40T (Green)	30/117-151	L060PBA	2645A628, 4222230M1
4255, 4355, 6255	1004.40T (Green)	30/117-162	L063PBA	2645A635, 4223976M1
4265, 4365, 6265	1004.40TW (Green)	30/117-163	L069PBA	2645K608, 4223737M1

Les références des pièces sont indicatives.
Nos pièces ne sont pas d'origine

Part numbers are quoted for reference purposes only.
Our parts and accessories are not original.

MF-126

"THE RELIABLE SERVICE"

Ed.1 (07/04)

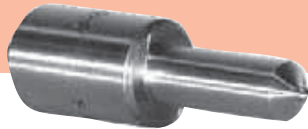
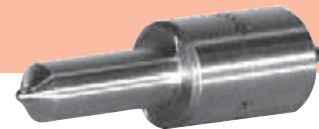
**NEZ D'INJECTEUR
INJECTOR NOZZLES**

Tracteurs Tractors	Moteur Engine	Réf. Ref.	N° du nez Nozzle N°	OEM
 Moteurs 6 cylindres / 6 cylinder engines				
399, 699 (L198026 ⇔), 1014 (TW31147), 3080	A6.354.4	30/117-42	JB6801022	2645A604, 1447829M91
699 (⇔ L198025), 1014 (TW31087), 1024, 1114, 1250, 2620, 2625, 2640, 2645, 2675, 3090, 3610	A6.354.4	30/117-39	BDLL150S6730	2646844, 1447269M91
1134, 2680, 2685, 2705, 3630	AT6.354.4	30/117-41	BDLL150S6737	2646845, 1447391M1
2720, 2725, 3650	AT6.354.4	30/117-43	JB6801019	2645A603, 1447658M1
396, 399, 3085, 3095, 4260, 4270, 6160, 6170	1006.6 (Blue)	30/117-158	6801106	2645A617, 3637185M1
3115	1006.6 (Blue)	30/117-135	6801058 JVM	2645A608, 3637195M1
3120, 3120T, 6180	1006.6T (Blue)	30/117-147	2645L616	2645L616, 3640674M1
3125, 3140, 3635 (YB31245)	1006.6T (Blue)	30/117-156	6801104	2645A616, 3637148M1
3635 (YB31262), 3645 (YB31264), 6190, 8110, 8120	1006.6T (Blue)	30/117-153	29-98106	2645L605, 3640672M1
3655, 3660 (YB31263), 8130	1006.6T (Blue)	30/117-152	7-01106	2645L612, 3640673M1
3655, 3660 (YB31236, YB31247)	1006.6T (Blue)	30/117-150		2645A614, 3638262M1
4260, 4360, 6260	1006.60 (Green)	30/117-154	L064 PBA	2645A627, 4222292M1
4270, 4370, 6170, 6270	1006.60T (Green)	30/117-157	L062 PBA	2645A629, 4222191M1
6180, 6280, 6290	1006.60T (Green)	30/117-151	L060 PBA	2645A628, 4222230M1
8120, 8220	1006.60T (Green)	30/117-148	L061 PBA CVM	2645A630, 4222256M1
8210	1006.60T (Green)	30/117-164	L065PBA DVM	2645A636, 4223761M1
3680, 3690	612DS	30/117-137	DLLA150S1029	V836339087, 3637645M1
3670, 8140, 8150, 8240	620DS	30/117-170	DLLA150S620	V836639957, 3638954M1
3690, 8160	634DS			
8250, 8260	634DSBAE	30/117-160	33877 39-02	V836854792
8250Xtra, 8260Xtra	634DWB AE	30/117-165	SDLLA145M35304	V836854937
8170, 8180, 8270, 8280	645DSBIE	30/117-159	DLLA143P495	V836354611
8270Xtra, 8280Xtra	645DSBAE	30/117-166	SDLLA145M35235	V836854930

Les références des pièces sont indicatives.
Nos pièces ne sont pas d'origine



"THE RELIABLE SERVICE"



Part numbers are quoted for reference purposes only.
Our parts and accessories are not original.

**NEZ D'INJECTEUR
INJECTOR NOZZLES**

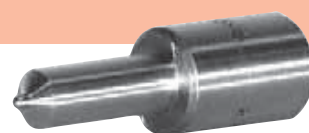

Tracteurs Tractors	Moteur Engine	Réf. Ref.	N° du nez Nozzle N°	OEM
4 Moissonneuses-batteuses moteurs 4 cylindres / 4 cylinder engines combinées				
8 Plot, 10Plot, 187, 206, 240	A4.236	30/117-9	BDLL150S6705	2646842, 1447227M1
16, 16Plot, 330	A4.236	30/117-62	BDLL150S6649	2646831, 1447235M1
20XP	AT4.236			
99, 307	A4.236	30/117-8	BDLL150S6556	2646690, 1446703M1
20, 430	A4.248	30/117-10	BDLL150S6737	2646826, 1447146M1
6 Moissonneuses-batteuses moteurs 6 cylindres / 6 cylinder engines combinées				
507, 510, 515, 520, 525	A6.354	30/117-38	BDLL150S6472	2646679, 883258M91
24, 530 S, 530, 535, 800, 805, 810, 815	A6.354.4	30/117-39	BDLL150S6730	2646844, 1447269M91
27, 29, 29XP, 31, 31XP, 840, 845, 850, 855, 860	AT6.345.4	30/117-43	JB6801019	2645A603, 1447658M1
560, 565, 660, 665, 750, 760, 820, 825, 830, 835, 850, 855, 860	AT6.354.4	30/117-41	BDLL150S6737	2646845, 1447391M1
750	A6.372.4	30/117-39	BDLL150S6730	2646844, 1447269M91
4 Chargeurs télescopiques / Telescopic handlers				
8925, 8926, 8937, 8939	1004.4 (Blue)	30/117-135	6801058 JVM	2645A608, 3637195M1
	1004.42 (Green)	30/117-146	L072PBA BVM	2645K609, 4222977M1
8925T, 8926T, 8937T, 8939T (Premiers / Early)	1004.4T (Blue)	30/117-167	JB6801052	2645A606, 3637169M1
	1004.40T (Green)	30/117-168	6801100	2645A615, 3640352M1
8925T, 8926T, 8937T, 8939T (Derniers / Late)	1004.40T (Green)	30/117-162	L063PBA	2645A635, 4223976M1
3 Tracteurs industriels moteurs 3 cylindres / 3 cylinder engine industrial tractors				
203, 205, 2135, 2203, 2205 (Premiers / Early)	AD3.152	30/117-3	BDL110S6133	2646607, 1447252M1
20, 20B, 20F, 30H 30E (CE31116, CE31138, CE31182, CE31183) 40 (CE20802, CE31084) 203, 205, 2135, 2203, 2205 (Derniers / Late)	AD3.152	30/117-34	BDLL150S6743	2646848, 1447474M1
20C, 20D, 20E, 30B, 30E (CE31144, CE31184), 40 (CE22438)	AD3.152	30/117-35	BDLL150S6602	2646825, 1446896M1
40E	AT3.152.4	30/117-36	JB6801029	2645K603, 3637320M1
4 Tracteurs industriels moteurs 4 cylindres / 4 cylinder engine industrial tractors				
702	23C	30/117-12	BDN12SPC6290	890007M2
50, 356, 3165, 3303, 3305	AD4.203	30/117-4	BDLL150S6372	2646676, 1853019M91
40B, 302, 304	AD4.203	30/117-34	BDLL150S6743	2646848, 1447474M1
50, 50B, 3303, 3305	A4.212	30/117-6	BDLL150S6555	2646689, 1446702M1
30D, 50, 50B, 50BMKII, 50C/D/E/H/H-S/H-T	A4.236	30/117-9	BDLL150S6705	2646842, 1447227M1
60HX, 60HX-T	AT4.236	30/117-37	JB6801027	3637319M1, 2645K602
50EX, 50HX, 50HX-S, 60H, 60H-S	A4.248	30/117-8	BDLL150S6556	2646690, 1446703M1
50HX-T	A4.248	30/117-10	BDLL150S6737	2646826, 1447146M1
70	A4.318	30/117-32	BDLL150S6599	2646824, 1446892M1
4 Fermec & Terex - Tracteurs industriels moteurs 4 cylindres / 4 cylinder engine industrial tractors				
760	1004.4 (Blue) 1004.4T (Blue)	30/117-135	6801058 JVM	2645A608, 3637195M1
760, 860, 960, 965	1004.40T (Green)	30/117-151	L060PBA	2645A628, 4222230M1

Les références des pièces sont indicatives.
Nos pièces ne sont pas d'origine

Part numbers are quoted for reference purposes only.
Our parts and accessories are not original.



"THE RELIABLE SERVICE"



**SYSTEME D'ALIMENTATION
FUEL SYSTEM**

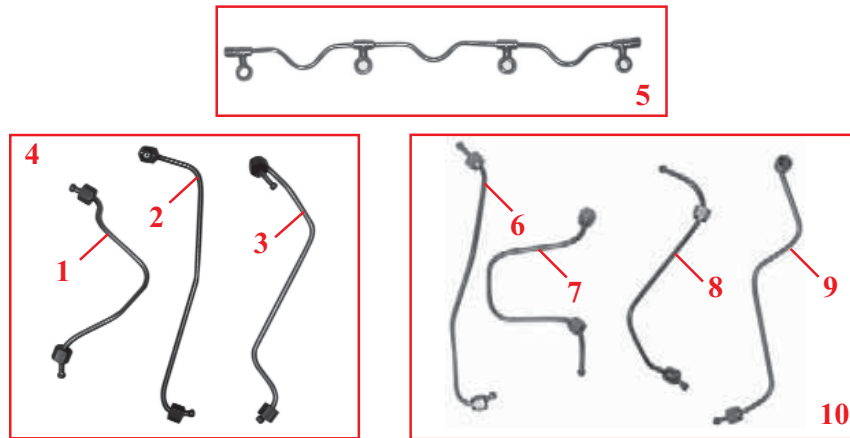

Tracteurs Tractors	Moteur Engine	Fig.	Réf. Ref.	OEM	Remarque Observation
3 Moteurs 3 cylindres / 3 cylinder engines					
133, 134, 135, 140, 145, 148, 230, 233, 234, 235, 240, 245, 250, 333, 334V, 340, 354V (⇒ 06/94)	AD3.152	1	30/127-1	35342023, 3638623M91	Tuyau d'injecteur n°1 Pipe n°1
		2	30/127-2	35342024, 3638624M91	Tuyau d'injecteur n°2 Pipe n°2
		3	30/127-3	35342025, 3638625M91	Tuyau d'injecteur n°3 Pipe n°3
		4	30/125-1	B12501	Kit des 3 tuyaux / 3 pipe set 30/127-1 + 30/127-2 + 30/127-3
4 Moteurs 4 cylindres / 4 cylinder engines					
165, 174, 186 168, 174, 175, 184, 265, 273, 274, 275, 283, 284, 565, 575, 675, 187, 206, 240, 307 178, 185, 188, 194, 285, 290, 293, 294, 397, 590, 690 (⇒ U937344L), 440, 487, 506	A4.212 A4.236 A4.248	5	30/126-2	35587344, 734723M91	Tuyau de retour d'injecteur Leak-off pipe
165, 174, 186 168, 174, 175, 184, 265, 273, 274, 275, 275E, 283, 284, 362, 362N, 365, 367CF, 372N, 373, 374, 375, 375E, 376C, 377, 383, 384, 387, 565, 575, 675, 3050, 3220, 3225, 8Plot, 10Plot, 16Plot, 16, 99, 187, 206, 240, 307, 330 20XP 178, 185, 188, 194, 285, 290, 290E, 293, 294, 382N, 390, 390E, 393, 394, 396C, 397, 590, 690, 3060, 20, 430, 440, 487, 506	A4.212 A4.236 AT4.236 A4.248	6	30/127-5	35343136, 3641094M91	Tuyau d'injecteur n°1 Pipe n°1
		7	30/127-6	35343137, 3641262M91	Tuyau d'injecteur n°2 Pipe n°2
		8	30/127-7	35343138, 3641095M91	Tuyau d'injecteur n°3 Pipe n°3
		9	30/127-8	35343139, 3641156M91	Tuyau d'injecteur n°4 Pipe n°4
		10	30/125-2	B12502	Kit des 4 tuyaux / 4 pipe set 30/127-5 + 30/127-6 + 30/127-7 + 30/127-8

PIECES DE PORTE-INJECTEUR / INJECTION-HOLDER PARTS

Réf. Ref.	Fig.	OEM	Dim. Size	Description
30/118-1	1	0920113, 826218M1	9/16" x 13/16"	Joint de nez d'injecteur Copper washer
30/118-2		0921173, 376091X1	3/8" x 13/16"	
30/113-1	2	0095315, 731567M1	5/16" UNF x 9/16"	Vis banjo pour injecteur Injector bolt
30/114-1	3	0921176, 376518X1	5/16" x 7/16"	Joint de vis banjo Copper washer

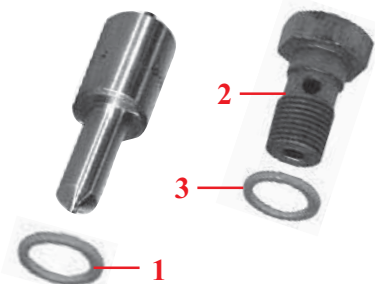

Les références des pièces sont indicatives.
Nos pièces ne sont pas d'origine

Part numbers are quoted for reference purposes only.
Our parts and accessories are not original.



JOINTS POUR FILTRES À COMBUSTIBLE FUEL PIPE RUBBER OLIVES

Par 20 pièces / By 20 pieces



Réf. Ref.	Hauteur Height	Ø ext. Outer Ø	Ø int. Inner Ø	Pour tuyau Ø For pipe Ø	OEM
30/9156-26	6.00mm	8.00mm	4.60mm	3/16"	33811112 376524X1
30/9156-27	6.00mm	10.70mm	6.14mm	1/4"	33811113 376525X1
30/9156-28	6.00mm	10.70mm	7.74mm	5/16"	33811114 376526X1
30/9156-29	6.00mm	9.12mm	6.14mm	1/4"	33811115 376527X1
30/9156-32	Jeu de 100 joints / Kit of 100 olives 20x9156-26 + 20x 9156-29 + 30x9156-27 + 30x9156-28				

TUYAUX D'ALIMENTATION FUEL PIPES

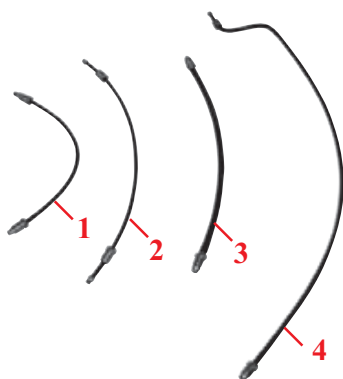

Tracteurs Tractors	Fig.	Réf. Ref.	OEM	Lg.
35, 133, 135, 140, 145	1	30/109-1	890322M92	370mm
133, 135, 140, 145, 148, 152, 155, 235, 240, 245, 250, 253, 255, 263	2	30/109-2	883712M94	450mm
65, 165, 765	3	30/109-3	892130M93	440mm
168, 265, 275, 285, 290	4	30/109-4	1667052M93	795mm

FILTRES CAV CAV FILTERS

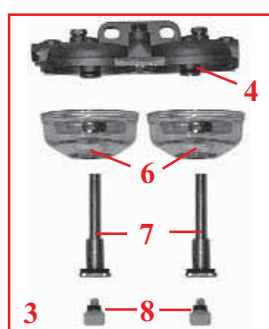

1	2	3	4	5	6	7	8
Filtre simple <i>Single filter</i>	Filtre double <i>Double filter</i>	Support sans filtre <i>Assy. less filter</i>	Couvercle <i>Cap</i>	Filtre <i>Filter</i>	Bol <i>Bowl</i>	Tube <i>Tube</i>	Robinet <i>Drain cock</i>
30/110-301 (883786M91, 2656615)		30/110-301R	30/110-16R (1630925M1)	60/111-3 (3405418M1) Repl. CAV 296	60/112-1 (1024386M1, 26560075) Repl. CAV 7111/403	30/110-18T (1039072M1)	30/110-19 (1890150M1)
	30/110-302 (1446891M91, 2656811)	30/110-302R	30/110-17R	60/111-5 (836218M91) CAV 296	60/112-2 (1890147M1, 26560111) Repl. CAV 7111/429		

Les références des pièces sont indicatives.
Nos pièces ne sont pas d'origine

Part numbers are quoted for reference purposes only.
Our parts and accessories are not original.

MF-130



"THE RELIABLE SERVICE"



Ed.1 (07/04)

**POMPES A EAU
WATER PUMPS**

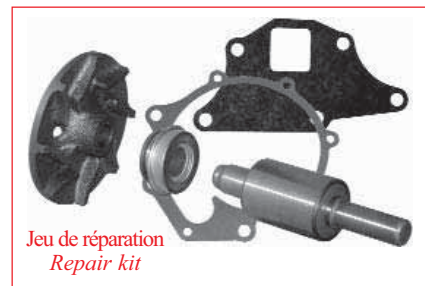
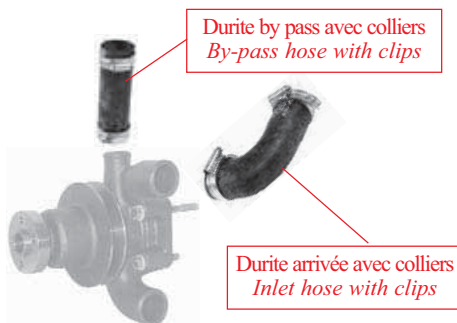
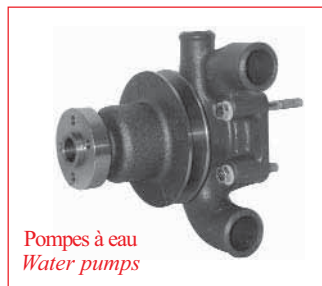











Tracteurs Tractors	Moteur Engine	Illustration	Pompe à eau Water pump	Jeu de rép. Repair kit	Durite by pass By-pass hose	Durite arrivée Inlet hose
3 Moteurs 3 cylindres / 3 cylinder engines						
35	A3.144		Support / Hub Ø 62.5mm Avec poulie With pulley 30/130-2 (41312784)	30/131-2 (58293, U7LW0105, 731774M91, 3641392M91)	30/141-3 (U5MH0006, 747936M91)	30/142-1 (U5MH0001, 747939M91)
35	A3.152		Sans poulie Without pulley 30/130-6 (U5MW0097, 3641823M91)			
135 (UK ⇒ UA5274D) 135, 140, 145 (France ⇒ FA1985D)	AD3.152		Sans poulie Without pulley 30/130-6 (U5MW0097, 3641823M91)			
133, 135	A3.144		Support / Hub Ø 79.5mm Avec poulie With pulley 30/130-3 (41312487)			
135	AG3.152		Sans poulie Without pulley 30/130-6 (U5MW0097, 3641823M91)			30/142-8 (U5MH0017, 3637574M91)
135 (UK UA5275D ⇒) 135, 140, 145 (France FA1986D ⇒) 133, 134, 148, 150, 152, 154, 230, 233, 234, 235, 240, 244CF, 245, 250, 253 (Italy), 254, 255, 333, 334V, 340, 342, 350, 353, 354, 356CF, 550, 2205, 3210	AD3.152		Sans poulie Without pulley 30/130-6 (U5MW0097, 3641823M91)			
164T, 253 (UK), 263T (Italy), 264T, 352, 355 360 (CN31187)	AT3.152.4					
360 (CN31185), 363, 364, 366CF	AT3.152.4					

Les références des pièces sont indicatives.
Nos pièces ne sont pas d'origine

Part numbers are quoted for reference purposes only.
Our parts and accessories are not original.



**POMPES A EAU
WATER PUMPS**









Tracteurs Tractors	Moteur Engine	Illustration	Pompe à eau Water pump	Jeu de rép. Repair kit	Durite by pass By-pass hose	Durite arrivée Inlet hose
Moteurs 4 cylindres / 4 cylinder engines						
TEA20 TED20 TEH20	85mm Petrol 85mm VO 85mm LO		30/130-1 (1885489M92)	30/131-1 (894920M91)	30/141-32 (57073)	
35, 135	87mm Petrol				30/141-66 (826257M1)	
TEF20	20C Diesel				30/141-1 (60582)	
FE35, 835	23C Diesel				30/141-2 (826199M1)	
25, 122	A4.99		Avec poulie With pulley 30/130-213 (41312459)	30/131-12 (U7LW0003, 748709M91)		
25, 30, 130, 825	A4.107		Sans poulie Without pulley 30/130-12 (U5MW0054, 748095M91)			
65	A4.192		Avec poulie With pulley 30/130-136 (41312574)	30/131-4 (U7LW0101, 3641393M91)	30/141-4 (U5MH0011, 3637426M91)	30/142-2 (U5MH0018, 747941M91)
65, 865	A4.203		Sans poulie Without pulley 30/130-4 (U5MW0089, 3641250M91)		(⇒UA97889D) 30/141-4 (U5MH0011, 3637426M91)	
65, 155, 158, 158MKIII, 165, 260, 560, 765	AD4.203				(UA97890D⇒) 30/141-64 (U5MH0021, 747942M91)	
165, 174	A4.212		Avec poulie simple With single pulley 30/130-137 (41312551)	Arbre / Shaft 1/2" UNF 30/131-6 (U7LW0025, 747965M91)		
168, 174, 175, 184, 255 (USA), 273, 274, 283, 284, 362, 362N, 367CF, 372N, 373, 374, 376C, 377, 383, 384, 387, 3220, 3225	A4.236		Sans poulie Without pulley 30/130-8 (U5MW0104, 3641832M91)		Arbre / Shaft 5/8" UNF 30/131-8 (U7LW0110, 3641383M91)	
178, 185, 188, 194, 293, 294, 382N, 393, 394, 396C, 397, 3235	A4.248					
168MKIII, 265, 275, 275E, 375E, 565, 575 675 Avec prise filetée aveugle With threaded blanking plug	A4.236		30/130-8 (U5MW0104, 3641832M91)	30/131-174 (U7LW0100, 3641283M91)		
285, 290, 290E, 390E, 590 690 Avec prise filetée aveugle With threaded blanking plug	A4.248					

Les références des pièces sont indicatives.
Nos pièces ne sont pas d'origine

Part numbers are quoted for reference purposes only.
Our parts and accessories are not original.



**POMPES A EAU
WATER PUMPS**







Tracteurs Tractors	Moteur Engine	Illustration	Pompe à eau Water pump	Jeu de rép. Repair kit	Durite by pass By-pass hose	Durite arrivée Inlet hose
Moteurs 4 cylindres / 4 cylinder engines						
675 Avec sortie pour chauffage <i>With heater outlet</i>	A4.236		30/130-71 (U5MW0188, U5MW0106, 4224460M91, 4222071M91)	30/131-8 (U7LW0110, 3641383M91)	30/141-11 (U5MH0024, 747944M91)	
690 Avec sortie pour chauffage <i>With heater outlet</i>	A4.248					
365, 375	A4.236		30/130-31 (U5MW0108, 4222002M91)	30/131-31 (U7LW0096, 3641333M91)	30/141-10 (U5MH0052, 3638251M91)	30/142-9 (U5MH0047, 3637573M91)
390	A4.248					
390T, 398, 698T, 1004T	AT4.236					
393TLX, 394TAQ, 396CT, 397T, 1007	AT4.236					
3050	A4.236					
3055, 3060	A4.248					
3065, 3065S, 3070	AT4.236				30/141-65 (U5MH0023, 747943M91)	
285 (USA)	A4.318		30/130-14 (41313272, 3641363M91)	30/131-13 (U7LW0156, 4224111M91)		30/142-17 (U5MH0025, 747945M91)
285 (USA), 298 (UK)	A4.318.2					
592, 595, 1080, 1085	A4.318		30/130-13 (U5MW0147, 3641887M91)			30/142-3 (U5MH0026, 747946M91)
298 (France), 592, 595, 698 (⇒ 1984)	A4.318.2					
698 (1984 ⇒), 1004	A4.318.2					
275E, 290E, 375E, 390E	A4.41		30/130-71 (U5MW0188, U5MW0106, 4224460M91, 4222071M91)	30/131-8 (U7LW0110, 3641383M91)	30/141-11 (U5MH0024, 747944M91)	
4225, 4235, 4240, 6110, 6120	A4.41 (Blue)					
3075, 4245, 4255, 6130, 6140, 6150	1004.4T (Blue)		30/130-31 (U5MW0108, 4222002M91)	30/131-31 (U7LW0096, 3641333M91)	30/141-131 (U5MH0053, 3640921M91)	
4225, 4325	1004.40 (Green)					
4235, 4245, 4255, 4345, 4355, 6235, 6245, 6255	1004.40T (Green)		30/130-194 (U5MW0189, 4224441M91)			
4235 (USA), 4335	1004.42 (Green)					
4265, 4365, 6265	1004.40TW		30/130-198 (U5MW0190, 4224475M91)	30/131-198 (U7LW0173, 4224675M91)	30/141-132 (U5MH0056, 4222846M91)	

Les références des pièces sont indicatives.
Nos pièces ne sont pas d'origine

Part numbers are quoted for reference purposes only.
Our parts and accessories are not original.



**POMPES A EAU
WATER PUMPS**



Tracteurs Tractors	Moteur Engine	Illustration	Pompe à eau Water pump	Jeu de rép. Repair kit	Durite by pass By-pass hose	Durite arrivée Inlet hose
Moteurs 6 cylindres / 6 cylinder engines						
1100 <i>Dernière version à thermostat double Later twin thermostat design</i>	A6.354		30/130-48 (U5MW0183, 4224118M91)	30/131-48 (U7LW0123, 3641382M91)		30/142-31 (U5MH0027, 747947M91)
1014, 1104, 1200	A6.354.1					
1105 1130 (354UA3356T ⇒) 1135	ATC6.354.1 AT6.354 AT6.354.1					
1250	A6.354.4					
2620, 2640 (⇒ 271212)	A6.354.4		30/130-49 (U5MW0129, 3641886M91)	30/131-49 (U7LW0097, 3641332M91)	30/141-60 (U5MH0032, 747950M91)	
399, 699, 1014, 1024, 1114 2620, 2640 (271213 ⇒) 2625, 2645, 2675, 3080, 3090, 3610	A6.354.4					
1134	AT6.354.4					
2680, 2685 (U691472K ⇒) 2720, 2725, 3630, 3650	AT6.354.4					
2680 (⇒ 271212)	AT6.354.4		30/130-88 (U5MW0128, 4222120M91)	30/131-88 (U7LW0128, 3641380M91)		30/142-16 (33855114, 3639969M1)
2680 (271213 ⇒ U691471K) 2685 (⇒ U691471K) 2705	AT6.354.4					
396, 399, 3085, 3095, 3115, 6160, 6170	1006.6 (Blue)					
3120, 3120T, 3125, 3140, 3635, 3645, 3655, 3660, 6180, 6190, 8110, 8120, 8130	1006.6T (Blue)					
6170, 6180	1006.60T (Green)		30/130-91 (U5MW0092, 4222028M91)	30/131-91 (U7LW0151, 4222467M91)		
8120	1006.60T (Green)					
4260, 4270	1006.6 (Blue)					
4260, 4360	1006.60 (Green)					
4270, 4370	1006.60T (Green)		30/130-197 (U5MW0156, 4222459M91)	30/131-197 (U7LW0148, 4222456M91)		30/141-133 (U5MH0050, 3637257M91)
4260, 4270	1006.6 (Blue)					
4260, 4360	1006.60 (Green)					
4270, 4370	1006.60T (Green)					
4270, 4370	1006.60T (Green)		30/130-199 (U5MW0160, 4222466M91)	30/131-91 (U7LW0151, 4222467M91)		
4260, 4270	1006.6 (Blue)					
4260, 4360	1006.60 (Green)					
4270, 4370	1006.60T (Green)					

Les références des pièces sont indicatives.
Nos pièces ne sont pas d'origine

Part numbers are quoted for reference purposes only.
Our parts and accessories are not original.







**POMPES A EAU
WATER PUMPS**

Tracteurs Tractors	Moteur Engine	Illustration	Pompe à eau Water pump	Jeu de rép. Repair kit	Durite by pass By-pass hose	Durite arrivée Inlet hose
Moteurs 6 cylindres / 6 cylinder engines						
6260	1006.60		30/130-194 (U5MW0189, 4224441M91)	30/131-198 (U7LW0173, 4224675M91)		
6270, 6280, 6290	1006.60T					
8210	1006.60T					
8220	1006.60T		30/130-198 (U5MW0190, 4224475M91)			30/141-63 (U5MH0063, 4223764M91)
3680, 3690	612DS					
3670, 8140, 8150	620DS					
3690, 8160	634DS					
8240	620DSRAE					
8250, 8260	634DSBAE					
8240Xtra	620DWBAE					
8250Xtra, 8260Xtra	634DWBAE					
8260	634DSBIE					

**JOINTS DE POMPE A EAU
WATER PUMP SEALS**

Joint Seal	Fig.
30/131-2B (2415216, 1446130M1) Ht. 17mm	
30/131-6S (2418M004, 3637576M1) Ht. 22mm	

**POULIE DE POMPE À EAU
WATER PUMP SINGLE PULLEY**









Tracteurs Tractors	Moteur Engine	Poulie Pulley	Fig.
165, 174,  186, 50, 50B, 3303, 3305	A4.212	30/131-8C (31146952)	
168, 174, 175, 184, 274, 274S  187, 206, 240, 307	A4.236		
178, 185, 188, 194, 284S, 294S  440, 487, 506	A4.248		

Les références des pièces sont indicatives.
Nos pièces ne sont pas d'origine

Part numbers are quoted for reference purposes only.
Our parts and accessories are not original.



POMPES A EAU
WATER PUMPS

Tracteurs Tractors	Moteur Engine	Illustration	Pompe à eau Water pump	Jeu de rép. Repair kit	Durite by pass By-pass hose	Durite arrivée Inlet hose
4 Moissonneuses-batteuses moteurs 4 cylindres / 4 cylinder engines combines						
186	A4.212		Avec poulie simple With single pulley 30/130-137 (41312551)	Arbre / Shaft 1/2" UNF 30/131-6 (U7LW0025, 747965M91)		
99, 187, 206, 240, 307	A4.236		Sans poulie Without pulley 30/130-8 (U5MW0104, 3641832M91)	Arbre / Shaft 5/8" UNF 30/131-8 (U7LW0110, 3641383M91)		
440, 487, 506	A4.248		30/130-8 (U5MW0104, 3641832M91)	 30/131-174 (U7LW0100, 3641283M91)		
8 Plot, 10 Plot, 16 Plot, 16, 330	A4.236		30/130-8 (U5MW0104, 3641832M91)			
20, 430	A4.248		30/130-71 (U5MW0188, U5MW0106, 4224460M91, 4222071M91)	30/131-8 (U7LW0110, 3641383M91)	30/141-65 (U5MH0023, 747943M91)	
20XP	AT4.236					
788	A4.270			30/131-11 (59093, 3639034M1)		
6 Moissonneuses-batteuses moteurs 6 cylindres / 6 cylinder engines combines						
500, 507, 510, 515, 520, 525	A6.354		30/130-10 (U5MW0111, 3641861M91)	30/131-10 (U7LW0118, 3641378M91)		

Les références des pièces sont indicatives.
Nos pièces ne sont pas d'origine

Part numbers are quoted for reference purposes only.
Our parts and accessories are not original.



**POMPES A EAU
WATER PUMPS**









Tracteurs Tractors	Moteur Engine	Illustration	Pompe à eau Water pump	Jeu de rép. Repair kit	Durite by pass By-pass hose	Durite arrivée Inlet hose
6 Moissonneuses-batteuses moteurs 6 cylindres / 6 cylinder engines combines						
24, 27	A6.354.4		30/130-49 (U5MW0129, 3641886M91)	30/131-49 (U7LW0097, 3641332M91)	30/141-60 (U5MH0032, 747950M91)	
530, 530S, 535, 800, 805, 810, 815	A6.354.4					
750	A6.372.4					
29	AT6.354.4		30/130-196 (U5MW0132, 4222001M91)		30/141-60 (U5MH0032, 747950M91)	
29XP, 31, 31XP, 560, 565, 660, 665, 750, 760, 820, 825, 830, 835, 840, 845, 850, 855, 860	AT6.354.4					
4 Chargeurs télescopiques / Telescopic handlers						
24	A4.236		30/130-8 (U5MW0104, 3641832M91)	30/131-8 (U7LW0110, 3641383M91)		
24T	AT4.236		30/130-31 (U5MW0108, 4222002M91)	30/131-31 (U7LW0096, 3641333M91)	30/141-11 (U5MH0024, 747944M91)	
8925, 8926, 8937, 8939	1004.4 (Blue)		30/130-90 (U5MW0157, 4223566M91)	30/131-90 (U7LW0149, 4223518M91)	30/141-133 (U5MH0050, 3637257M91)	
8925T, 8926T, 8937T, 8939T	1004.4T (Blue)					
8925, 8926, 8937, 8939	1004.42 (Green)		30/130-194 (U5MW0189, 4224441M91)	30/131-198 (U7LW0173, 4224675M91)	30/141-132 (U5MH0056, 4222846M91)	
8925T, 8926T, 8937T, 8939T	1004.40T (Green)					

Les références des pièces sont indicatives.
Nos pièces ne sont pas d'origine

Part numbers are quoted for reference purposes only.
Our parts and accessories are not original.



**POMPES A EAU
WATER PUMPS**









Tracteurs Tractors	Moteur Engine	Illustration	Pompe à eau Water pump	Jeu de rép. Repair kit	Durite by pass By-pass hose	Durite arrivée Inlet hose
Tracteurs industriels moteurs 3 cylindres / 3 cylinder engine industrial tractors						
203, 205	A3.152		Support / Hub Ø 62.5mm Avec poulie With pulley 30/130-2 (41312784)			
203, 205, 2135 (⇒ UA5274D)	AD3.152		Sans poulie Without pulley 30/130-6 (U5MW0097, 3641823M91)	30/131-2 (58293, U7LW0105, 731774M91, 3641392M91)	30/141-3 (U5MH0006, 747936M91)	30/142-1 (U5MH0001, 747939M91)
203, 205, 2135 (UA5275D ⇒) 20, 20B, 20C, 20D, 20E, 20F, 30B, 30E, 30H, 40, 2203, 2205	AD3.152		Support / Hub Ø 79.5mm Avec poulie With pulley 30/130-3 (41312487)			
20, 40	AG3.152		Sans poulie Without pulley 30/130-6 (U5MW0097, 3641823M91)			
40E (CN31157, CN31158)	AT3.152.4					30/142-8 (U5MH0017, 3637574M91)
40E (CN31195, CN31196)	AT3.152.4					
Tracteurs industriels moteurs 4 cylindres / 4 cylinder engine industrial tractors						
702	23C Diesel		30/130-1 (1885489M92)	30/131-1 (894920M91)	30/141-2 (826199M1)	
356	A4.203		Avec poulie With pulley 30/130-136 (41312574)	30/131-4 (U7LW0101, 3641393M91)	30/141-4 (U5MH0011, 3637426M91)	30/142-2 (U5MH0018, 747941M91)
30, 40B, 50, 302, 304, 356, 3165, 3303, 3305	AD4.203		Sans poulie Without pulley 30/130-4 (U5MW0089, 3641250M91)		(⇒UA97889D) 30/141-4 (U5MH0011, 3637426M91) (UA97890D⇒) 30/141-64 (U5MH0021, 747942M91)	

Les références des pièces sont indicatives.
Nos pièces ne sont pas d'origine

Part numbers are quoted for reference purposes only.
Our parts and accessories are not original.

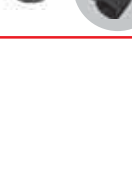

**POMPES A EAU
WATER PUMPS**

Tracteurs Tractors	Moteur Engine	Illustration	Pompe à eau Water pump	Jeu de rép. Repair kit	Durite by pass By-pass hose	Durite arrivée Inlet hose
Tracteurs industriels moteurs 3 cylindres / 3 cylinder engine industrial tractors						
50, 50B, 3303, 3305	A4.212		Avec poulie simple With single pulley 30/130-137 (41312551)			
50, 50B, 50BMKII, 50C, 50D 50H (LD31122, LD31134) 60	A4.236		Sans poulie Without pulley 30/130-8 (U5MW0104, 3641832M91)	30/131-8 (U7LW0110, 3641383M91)		
50HX, 60H (LF31128, LF31130, LF31135)	A4.248			30/131-174 (U7LW0100, 3641283M91)		
30D, 50E, 50H (LD31163, LD31179) 50H-S, 50H-T	A4.236		30/130-8 (U5MW0104, 3641832M91)			
50EX 50HX, 60H (LF31164, LF31180) 50HX-S, 50HX-T, 60H-S	A4.248					
60HX, 60HX-T	AT4.236		30/130-31 (U5MW0108, 4222002M91)	30/131-31 (U7LW0096, 3641333M91)	30/141-11 (U5MH0024, 747944M91)	
70	A4.318		30/130-14 (41313272, 3641363M91)	30/131-13 (U7LW0156, 4224111M91)		30/142-17 (U5MH0025, 747945M91)
Ferme & Terex - Tracteurs industriels moteurs 4 cylindres / 4 cylinder engine industrial tractors						
750	1004.4 (Blue)		30/130-31 (U5MW0108, 4222002M91)	30/131-31 (U7LW0096, 3641333M91)		
760, 860, 860S, 860SE, 865, 960, 965	1004.4T (Blue)				30/141-131 (U5MH0053, 3640921M91)	
750, 750B	1004.42 (Green)					
760, 760B, 860, 860B, 860S, 860SE, 960, 960B, 965	1004.40T (Green)					

Les références des pièces sont indicatives.
Nos pièces ne sont pas d'origine

Part numbers are quoted for reference purposes only.
Our parts and accessories are not original.



**DURITES DE POMPES A EAU
WATER PUMP HOSES**

Durites (Toutes les durites sont fournies avec colliers) / Hoses (All hoses are supplied with clips)

30/141-1 	30/141-2 	30/141-3 	30/141-4 
30/141-10 	30/141-11 	30/141-12 	30/141-32 
30/141-60 	30/141-61 	30/141-62 	30/141-63 
30/141-64 	30/141-65 	30/141-131 	30/141-132 
30/141-133 		30/142-1 	30/142-2 
30/142-3 	30/142-8 	30/142-9 	30/142-16 
30/142-17 	30/142-30 	30/142-31 	

Les références des pièces sont indicatives.
Nos pièces ne sont pas d'origine

Part numbers are quoted for reference purposes only.
Our parts and accessories are not original.



THERMOSTATS & COURROIES
THERMOSTATS & 'V' BELTS



Tracteurs Tractors	Moteur Engine	Thermostat	Joint Gasket	Support Housing	Courroie de ventilateur Fan belt
3 Moteurs 3 cylindres / 3 cylinder engines					
35 35	A3.144 A3.152	30/143-3 (2485666, 1446165M91)	30/147-12 (36834169, 4222057M1)	30/146-3 (37766363, 746835M1)	1175mm 1200mm 30/144-2 (A) 30/144-3 (A) (0070078, (0070106, 1851749M1) 890982M1)
135	AG3.152				30/144-3 (A) (0070106, 890982M1)
133, 135	A3.144				Dynamo Altern. 1200mm 1268mm 30/144-3 (A) 30/144-4 (A) (0070106, (0070108, 890982M1) 893575M1)
133, 135, 140, 145, 148, 150, 152	AD3.152				Dynamo - 1185mm 30/144-206 (D) (2614B143, 1447784M91) 1212mm 1235mm 30/144-100 (C) 30/144-230 (D) (2614B645, (2614B647, 3637597M1) 3637978M91)
134, 154, 233, 234, 253 (Italy), 254	AD3.152				1325mm 30/144-5 (A) (1876670M1)
235, 245, 250 (France), 255 240 (⇒ 513537) 550 (⇒ 620620)	AD3.152				1300mm 30/144-128 (D) (2614B652, 3637306M91)
240 (513538 ⇒ 522353) 550 (620621 ⇒)	AD3.152				1325mm 1275mm 30/144-21 (C) 30/144-212 (C) (2614B154, (2614B050, 1687531M1) 1688988M1)
230 240 (522354 ⇒) 250 (UK)	AD3.152				30/144-29 (C) (2614B642, 1693746M1)
244CF, 333, 334V, 340, 342, 350, 353, 354, 356CF, 2205, 3210	AD3.152				30/144-100 (C) (2614B645, 3637597M1)
264T, 263T (Italy), 264T	AT3.152.4				⇒ 13/09/01 14/09/01 ⇒ Iska alternat. 1175mm 1200mm 30/144-29 (C) 30/144-30 (C) (2614B642, (3612115M1) 1693746M1)
253 (UK)	AT3.152.4				30/144-29 (C) (2614B642, 1693746M1)
352, 355 360 (CN31187)	AT3.152.4				
360 (CN31185) 363, 364, 366CF	AT3.152.4				30/143-18 (2485613, 1447384M1)

(A) Courroie trapézoïdale simple / *Single wrapped wedge belt*
(B) Paire de courroies trapézoïdales / *Pair of wrapped wedge belt*
(C) Courroie crantée simple / *Single raw edge cogged belt*
(D) Paire de courroies crantées / *Pair of raw edge cogged belts*
(E) Courroie Multi V / *Multi V belt*

Les références des pièces sont indicatives.
Nos pièces ne sont pas d'origine

Part numbers are quoted for reference purposes only.
Our parts and accessories are not original.



THERMOSTATS & COURROIES
THERMOSTATS & 'V'BELTS

Tracteurs Tractors	Moteur Engine	Thermostat	Joint Gasket	Courroie de ventilateur Fan belt	Courroie compress. air Air compressor belt
3 Moteurs 3 cylindres / 3 cylinder engines					
263 (UK)	903.27T	30/143-18 (2485613, 1447384M1)	30/147-12 (36834169, 4222057M1)	⇒ 13/09/01 14/09/01 ⇒ Iska alternat. 1175mm 1200mm 30/144-29 (C) 30/144-30 (C) (2614B642, 1693746M1) (3612115M1)	
2210 2220	903.27 903.27T			30/144-238 (A) (3649058M1)	
3315 3325	903.27 903.27T			30/144-214 (C) (2.4119.149.0/1)	
4215, 4315 4220, 4320	903.27 903.27T			30/144-212 (C) (2614B050, 1688988M1)	
4 Moteurs 4 cylindres / 4 cylinder engines					
TEA20	85mm Petrol	30/143-57 (1645921M1)	30/147-13 (3910266M1)	30/144-263 (A) (641696M1)	
TED20 TEH20	85mm VO 85mm LO	30/143-5 (1446127M91)		30/144-1 (A) (826960M1)	
TEF20	20C Diesel	30/143-2 (1894961M1)		20x975mm 13x1060mm 30/144-262 (A) 30/144-264 (C) (629004M1) (828729M1)	
FE35, 835	23C Diesel			30/144-264 (C) (828729M1)	
35	87mm Petrol	30/143-3 (2485666, 1446165M91)	30/147-12 (36834169, 4222057M1)	1050mm 1008mm 30/144-232 (D) 30/144-267 (C) (2614B632, 3639680M1) (966427M1)	
135	87mm Petrol			30/144-2 (A) 30/144-3 (A) (0070078, 1851749M1) (0070106, 890982M1)	
25, 122 25, 30, 130, 825	A4.99 A4.107			30/144-3 (A) (0070106, 890982M1)	
65 65, 865	A4.192 A4.203	30/143-4 (2485668, 1446222M91)	30/147-22 (36835442, 4223424M1)	30/144-3 (A) (0070106, 890982M1)	
65, 165 (UK), 765	AD4.203			Dynamo 1200mm 30/144-3 (A) 30/144-225 (D) (0070106, 890982M1) (3582952M1)	
155, 158, 158MKIII, 165 (France)	AD4.203			30/144-4 (A) (0070108, 893575M1)	
260, 560	AD4.203				

- (A) Courroie trapézoïdale simple / Single wrapped wedge belt
 (B) Paire de courroies trapézoïdales / Pair of wrapped wedge belt
 (C) Courroie crantée simple / Single raw edge cogged belt
 (D) Paire de courroies crantées / Pair of raw edge cogged belts
 (E) Courroie Multi V / Multi V belt

Les références des pièces sont indicatives.
 Nos pièces ne sont pas d'origine

Part numbers are quoted for reference purposes only.
 Our parts and accessories are not original.



THERMOSTATS & COURROIES THERMOSTATS & 'V' BELTS

Tracteurs Tractors	Moteur Engine	Thermostat	Joint Gasket	Courroie de ventilateur Fan belt	Courroie compress. air Air compressor belt	
Moteurs 4 cylindres / 4 cylinder engines						
165 (UK) 168 (UK), 175 (UK) 178 (UK), 185 (UK), 188 (UK)	A4.212 A4.236 A4.248	30/143-5 (2485659, 1446127M91)	30/147-14 (36862201, 4222011M1)	30/144-4 (A) (0070108, 893575M1)		
165 (France) 168 (France), 175 (France) 178 (France), 185 (France), 188 (France)	A4.212 A4.236 A4.248			Dynamo 1232mm 30/144-266 (A) (960972M1)	Altern. 1268mm 30/144-4 (A) (0070108, 893575M1)	
168MKIII	A4.236			Dynamo Lucas 1232mm 30/144-266 (A) (960972M1)	Dynamo Paris Rhone 1268mm 30/144-4 (A) (0070108, 893575M1)	
174 174, 184 194	A4.212 A4.236 A4.248			Altern. 1380mm 30/144-22 (C) (2614B659, 1447778M91)		
265 (UK), 275 (UK) 290 (UK)	A4.236 A4.248			Dynamo 1185mm 30/144-206 (D) (2614B143, 1447784M91)	Altern. 1212mm 30/144-100 (C) (2614B645, 3637597M1)	
265 (France), 275 (France) 285, 290 (France)	A4.236 A4.248			1400mm 30/144-6 (A) (1669923M1)	1380mm 30/144-22 (C) (2614B659, 1447778M91)	
273, 274, 274S, 283, 284 293, 294	A4.236 A4.248			1400mm 30/144-6 (A) (1669923M1)	1375mm 30/144-34 (C) (3581611M1)	
274SK, 284S 294S	A4.236 A4.248			1212mm 30/144-100 (C) (2614B645, 3637597M1)	1185mm 30/144-206 (D) (2614B143, 1447784M91)	
274C, 274CF 294C	A4.236 A4.248			1300mm 30/144-128 (D) (2614B652, 3637306M91)	1275mm 30/144-229 (D) (2614B650, 3637598M91)	
275E, 375E 290E, 390E	A4.236 A4.248			30/147-14 (36862201, 4222011M1) LD31289, LF31255 30/147-31 (36862225, 3641893M1)	⇒ 12/02/92 1380mm 30/144-22 (C) (2614B659, 1447778M91)	13/02/92 ⇒ 1325mm 30/144-21 (C) (2614B154, 1687531M1)

- (A) Courroie trapézoïdale simple / *Single wrapped wedge belt*
 (B) Paire de courroies trapézoïdales / *Pair of wrapped wedge belt*
 (C) Courroie crantée simple / *Single raw edge cogged belt*
 (D) Paire de courroies crantées / *Pair of raw edge cogged belts*
 (E) Courroie Multi V / *Multi V belt*

Les références des pièces sont indicatives.
 Nos pièces ne sont pas d'origine

Part numbers are quoted for reference purposes only.
 Our parts and accessories are not original.



THERMOSTATS & COURROIES THERMOSTATS & 'V'BELTS

Tracteurs Tractors	Moteur Engine	Thermostat	Joint Gasket	Courroie de ventilateur Fan belt	Courroie compress. air Air compressor belt
Moteurs 4 cylindres / 4 cylinder engines					
362	A4.236	30/143-3 (2485666, 1446165M91)	30/147-15 (36834152, 3641766M1)	30/144-30 (C) (3612115M1)	
362N, 372N 382N	A4.236 A4.248			Airco 30/144-30 (C) 10x1175mm (3612115M1) 30/144-240 (D) (3761507M91)	30/144-239 (C) (3700656M1)
365, 375 390 390T, 398	A4.236 A4.248 AT4.236	30/143-18 (2485613, 1447384M1)		Airco 30/144-31 (C) 13x1500mm (1693745M1) 30/144-126 (D) (1687610M91)	30/144-226 (C) (3612930M1)
367CF, 373, 374, 376C, 377, 383, 384, 387, 3220, 3225 393, 394, 396C, 397, 3235	A4.236 A4.248	30/143-5 (2485659, 1446127M91)	30/147-14 (36862201, 4222011M1) <i>ou / or</i> 30/147-31 (36862225, 3641893M1)	⇒ 12/88 01/89 ⇒ 1175mm 1200mm 30/144-29 (C) (2614B642, 1693746M1) 30/144-233 (D) (2614B644, 3639683M1)	
393TLX, 394TAQ, 396CT, 397T, 1007	AT4.236	30/143-18 (2485613, 1447384M1)	30/147-15 (36834152, 3641766M1)	30/144-234 (D) (2614B653, 3639685M1)	
565, 575 (UK) 590 (UK)	A4.236 A4.248	30/143-5 (2485659, 1446127M91)	30/147-14 (36862201, 4222011M1)	1400mm 1380mm 30/144-6 (A) (1669923M1) 30/144-22 (C) (2614B659, 1447778M91)	
575 (France) 590 (France)	A4.236 A4.248			1400mm 1375mm 30/144-6 (A) (1669923M1) 30/144-34 (C) (3581611M1)	
675 (UK) 690 (UK)	A4.236 A4.248	30/143-3 (2485666, 1446165M91)	30/147-15 (36834152, 3641766M1)	30/144-22 (C) (2614B659, 1447778M91)	
675 (France) 690 (France)	A4.236 A4.248			Airco 13x1375mm 10x1387mm 30/144-34 (C) (3581611M1) 30/144-208 (D) (1686614M91)	30/144-267 (C) (966427M1)
698T 1004T	AT4.236 AT4.236			30/144-126 (D) (1687610M91)	30/144-210 (C) (1686837M1)
3050	A4.236	30/143-18 (2485613, 1447384M1)	30/147-15 (36834152, 3641766M1)	Airco 13x1375mm 10x1375mm 30/144-34 (C) (3581611M1) 30/144-35 (D) (3383044M91)	30/144-290 (C) (1690692M1, 3581635M1)
3055, 3060	A4.248			30/144-35 (D) (3383044M91)	
3065, 3065S, 3070	AT4.236				

- (A) Courroie trapézoïdale simple / Single wrapped wedge belt
 (B) Paire de courroies trapézoïdales / Pair of wrapped wedge belt
 (C) Courroie crantée simple / Single raw edge cogged belt
 (D) Paire de courroies crantées / Pair of raw edge cogged belts
 (E) Courroie Multi V / Multi V belt

Les références des pièces sont indicatives.
 Nos pièces ne sont pas d'origine

Part numbers are quoted for reference purposes only.
 Our parts and accessories are not original.



THERMOSTATS & COURROIES THERMOSTATS & 'V' BELTS

Tracteurs Tractors	Moteur Engine	Thermostat	Joint Gasket	Courroie de ventilateur Fan belt	Courroie compress. air Air compressor belt
Moteurs 4 cylindres / 4 cylinder engines					
298 (UK)	A4.318.2	30/143-3 (2485666, 1446165M91)	30/147-15 (36834152, 3641766M1)	30/144-209 (D) (1686616M91)	
298 (France), 592, 595	A4.318 A4.318.2			30/144-13 (A) (1809095M2)	
698, 1004	A4.318.2			⇒ 1984 1984 ⇒ 12.5x1518mm 10x1495mm 30/144-13 (A) 30/144-126 (D) (1809095M2) (1687610M91)	
1080 (France)	A4.318			Paris-Rhone Delco Remy 1535mm 1518mm 30/144-265 (B) 30/144-13 (A) (906424M2) (1809095M2)	
1080 (USA)	A4.318			30/144-257 (C) (516467M1)	30/144-269 (C) (522063M1)
1085 (USA)	A4.318			30/144-299 (D) (529900M91)	
275E, 290E, 375E, 390E	A4.41			30/143-18 (2485613, 1447384M1)	30/144-21 (C) (2614B154, 1687531M1)
374, 3220	1004.40 (Green)	30/143-55 (2485C036, 4224639M1)	30/147-16 (3683R009, 4222986M1)	30/144-237 (C) (3648900M1)	
394, 3235	1004.42 (Green)				
2230	1004.42			30/144-275 (C) (3651229M1)	
3075	1004.4T	30/143-18 (2485613, 1447384M1)	30/147-15 (36834152, 3641766M1)	30/144-228 (D) (3619356M91)	Sanjo - 1050mm 30/144-290 (C) (3581635M1) Sanden - 1025mm 30/144-270 (C) (3712531M1)
3330 3340 3350, 3355	1004.40 1004.42 1004.40T	30/143-55 (2485C036, 4224639M1)	30/147-16 (3683R009, 4222986M1)	30/144-295 (C) (2.4119.139.0)	
4225, 4235, 4240	A4.41 (Blue)	30/143-18 (2485613, 1447384M1)	30/147-15 (36834152, 3641766M1)	45A, 80A 120A & Airco 13x1385mm 10x1385mm 30/144-247 (C) 30/144-248 (D) (3808704M1) (3808705M1)	30/144-294 (C) (3809174M1)
4245, 4255	1004.4T (Blue)				
4225HV, 4235HV	A4.41 (Blue)			45A, 80A 120A & Airco 13x1275mm 10x1275mm 30/144-212 (C) 30/144-251 (D) (2614B050, (3810420M91) 1688988M1)	30/144-227 (C) (3614715M2)
4245HV, 4255HV	1004.4T (Blue)				

- (A) Courroie trapézoïdale simple / *Single wrapped wedge belt*
 (B) Paire de courroies trapézoïdales / *Pair of wrapped wedge belt*
 (C) Courroie crantée simple / *Single raw edge cogged belt*
 (D) Paire de courroies crantées / *Pair of raw edge cogged belts*
 (E) Courroie Multi V / *Multi V belt*

Les références des pièces sont indicatives.
 Nos pièces ne sont pas d'origine

Part numbers are quoted for reference purposes only.
 Our parts and accessories are not original.



THERMOSTATS & COURROIES THERMOSTATS & 'V'BELTS

Tracteurs Tractors	Moteur Engine	Thermostat	Joint Gasket	Courroie de ventilateur Fan belt	Courroie compress. air Air compressor belt
Moteurs 4 cylindres / 4 cylinder engines					
4225, 4235	1004.40 (Green)	30/143-55 (2485C036, 4224639M1)	⇒ U933891D Joint / Gasket 30/147-17 (3684N017, 4222851M1) U933892D ⇒ O' Ring 30/147-18 (2415H492, 4223842M1)	45A, 80A 120A & Airco 1410mm 1400mm 30/144-252 (C) 30/144-254 (D) (3815255M2) (3817582M1)	30/144-211 (C) (1686883M1)
4235 (USA), 4335	1004.42 (Green)				
4235, 4245, 4255, 4345, 4355	1004.40T (Green)				
4265, 4365	1004.40TW (Green)				
4225HV, 4325HV	1004.40 (Green)				
4235HV (USA), 4335HV	1004.42 (Green)				
4235HV, 4245HV, 4255HV, 4345HV, 4355HV	1004.40T (Green)				
6110, 6120	A4.41	30/143-18 (2485613, 1447384M1)	30/147-15 (36834152, 3641766M1)	30/144-228 (D) (3619356M91)	30/144-270 (C) (3712531M1)
6130, 6140, 6150	1004.4T				
6235	1004.40T	30/143-55 (2485C036, 4224639M1)	⇒ U933891D Joint / Gasket 30/147-17 (3684N017, 4222851M1) U933892D ⇒ O' Ring 30/147-18 (2415H492, 4223842M1)	70A 80A 1475mm 1425mm 30/144-101 (D) 30/144-245 (D) (3780608M91) (3780606M91)	30/144-222 (C) (3389525M1)
				120A - Iska 1410mm 30/144-243 (D) (3780138M91)	
6235HV	1004.40T			70A 80-120A 1345mm 1325mm 30/144-246 (D) 30/144-244 (D) (3780616M91) (3780605M91)	
6245, 6255	1004.40T			70-80A 120A 1425mm 1410mm 30/144-245 (D) 30/144-243 (D) (3780606M91) (3780138M91)	
6245HV, 6255HV	1004.40T			70-120A - Iska 80-120A - Valeo 1325mm 1300mm 30/144-244 (D) 30/144-292 (D) (3780605M91) (3780603M91)	
6265	1004.40TW			70A 80A 1410mm 1425mm 30/144-243 (D) 30/144-245 (D) (3780138M91) (3780606M91)	
		120A 1400mm 30/144-293 (D) (3780607M91)			

- (A) Courroie trapézoïdale simple / Single wrapped wedge belt
 (B) Paire de courroies trapézoïdales / Pair of wrapped wedge belt
 (C) Courroie crantée simple / Single raw edge cogged belt
 (D) Paire de courroies crantées / Pair of raw edge cogged belts
 (E) Courroie Multi V / Multi V belt

Les références des pièces sont indicatives.
 Nos pièces ne sont pas d'origine

Part numbers are quoted for reference purposes only.
 Our parts and accessories are not original.



THERMOSTATS & COURROIES THERMOSTATS & 'V' BELTS

Tracteurs Tractors	Moteur Engine	Thermostat	Joint Gasket	Courroie de ventilateur Fan belt	Courroie compress. air Air compressor belt
Moteurs 6 cylindres / 6 cylinder engines					
1100 1130 Pompe à 1 thermostat Single thermostat pump	A6.354 AT6.354	30/143-4 (2485668, 1446222M91)	30/147-15 (36834152 3641766M1)	1450mm 1485mm 30/144-125 (D) 30/144-37 (D) (1688216M91) (3617180M91)	30/144-258 (C) (521110M1)
1100 1130 Pompe à 2 thermostats Double thermostat pump	A6.354 AT6.354	30/143-3 (2485666, 1446165M91)			
1105 1135	ATC6.354.1 AT6.354.1				
1014	A6.354.1	<i>Et / And</i>		30/144-101 (D) (2614B166, 1447695M91, 3780608M91)	
1104	A6.354.1	30/143-18 (2485613, 1447384M1)		30/144-235 (D) (2614B668, 3639692M1)	
1200	A6.354.1			30/144-231 (D) (2614A171, 3639674M1)	
399	A6.354.4			30/144-33 (D) (3595070M91)	30/144-290 (C) (1690692M1, 3581635M1)
699	A6.354.4			30/144-125 (D) (1688216M91)	30/144-211 (C) (1686883M1)
1014 (TW31087)	A6.354.4			1325mm 1512mm 30/144-298 (D) 30/144-102 (D) (2614B654, (2614B669, 3639686M1) 1447418M91)	
1014 (TW31147) 1024	A6.354.4			1485mm 1512mm 30/144-236 (D) 30/144-102 (D) (2614B667, (2614B669, 3640473M1) 1447418M91)	
1114	A6.354.4	30/143-18 (2485613, 1447384M1)	30/147-19 (36861757, 4222906M1)	1485mm 1525mm 30/144-236 (D) 30/144-36 (D) (2614B667, (2614B670, 3640473M1) 3381364M91)	
1250	A6.354.4			30/144-204 (D) (2614B656, 1447407M91)	
2620, 2625	A6.354.4			30/144-13 (C) (1809095M2)	
2640 (⇒ 271212)	A6.354.4			Altern. Ventil. / Fan 1008mm 1485mm 30/144-267 (C) 30/144-37 (D) (966427M1) (3617180M91)	General Motors 1165mm 30/144-221 (C) (3386214M1)
2640 (271213 ⇒)	A6.354.4	Altern. Ventil. / Fan 1008mm 1485mm 30/144-267 (C) 30/144-37 (D) (966427M1) (3617180M91)			
2645	A6.354.4			Altern. & Ventil. / Altern. & Fan 1525mm 30/144-36 (D) (3381364M91)	Sankō 1100mm 30/144-211 (C) (1686883M1)

- (A) Courroie trapézoïdale simple / Single wrapped wedge belt
 (B) Paire de courroies trapézoïdales / Pair of wrapped wedge belt
 (C) Courroie crantée simple / Single raw edge cogged belt
 (D) Paire de courroies crantées / Pair of raw edge cogged belts
 (E) Courroie Multi V / Multi V belt

Les références des pièces sont indicatives.
 Nos pièces ne sont pas d'origine

Part numbers are quoted for reference purposes only.
 Our parts and accessories are not original.



THERMOSTATS & COURROIES
THERMOSTATS & 'V'BELTS

Tracteurs Tractors	Moteur Engine	Thermostat	Joint Gasket	Courroie de ventilateur Fan belt	Courroie compress. air Air compressor belt	
Moteurs 6 cylindres / 6 cylinder engines						
2675	A6.354.4	30/143-18 (2485613, 1447384M1)	30/147-19 (36861757, 4222906M1)	Altern. 1008mm 30/144-267 (C) (966427M1)	Ventil. / Fan 1485mm 30/144-37 (D) (3617180M91)	30/144-296 (C) (3323729M1)
3080, 3090, 3610	A6.354.4			30/144-36 (D) (3381364M91)		30/144-211 (C) (1686883M1)
1134	AT6.354.4			1525mm 30/144-36 (D) (2614B670, 3381364M91)	1562mm 30/144-103 (D) (2614B673, 4223957M91)	
2680	AT6.354.4					General Motors 1165mm 30/144-221 (C) (3386214M1)
2685, 2720, 2725	AT6.354.4				30/144-37 (D) (3617180M91)	Sanjo 1100mm 30/144-211 (C) (1686883M1)
2705	AT6.354.4					30/144-296 (C) (3323729M1)
3630, 3650	AT6.354.4					30/144-211 (C) (1686883M1)
396, 399	1006.6				30/144-36 (D) (3381364M91)	30/144-227 (C) (3614715M2)
3085, 3095, 3115	1006.6				30/144-37 (D) (3617180M91)	30/144-225 (D) (3582952M1)
3120, 3120T	1006.6T				30/144-124 (D) (3619084M91)	
3125, 3140, 3635 3645 (YB31246)	1006.6T				30/144-127 (D) (3582953M91)	Sanjo - 1165mm 30/144-221 (C) (3386214M1)
3645 (YB31233)	1006.6T				30/144-271 (D) (3617178M91)	
3645 (YB31264) 3655, 3660	1006.6T				30/144-123 (D) (3616512M91)	Sanden - 1025mm 30/144-270 (C) (3712531M1)
4260, 4270	1006.6 (Blue)				30/147-20 (3684A004, 3638700M1)	120 A 1410mm 1425mm 30/144-249 (D) 30/144-242 (D) (3808730M1) (3779379M91)
4260, 4360	1006.60 (Green)					
4270, 4370	1006.60T (Green)					
6160, 6170	1006.6 (Blue)		30/144-37 (D) (3617180M91)			
6170	1006.60T (Green)			30/144-272 (C) (3714894M1)		
6180	1006.6T (Blue)		Valeo 1465mm 30/144-124 (D) (3619084M91)	Magneti Marelli 1485mm 30/144-37 (D) (3617180M91)		
6180	1006.60T (Green)					

- (A) Courroie trapézoïdale simple / Single wrapped wedge belt
 (B) Paire de courroies trapézoïdales / Pair of wrapped wedge belt
 (C) Courroie crantée simple / Single raw edge cogged belt
 (D) Paire de courroies crantées / Pair of raw edge cogged belts
 (E) Courroie Multi V / Multi V belt

Les références des pièces sont indicatives.
 Nos pièces ne sont pas d'origine

Part numbers are quoted for reference purposes only.
 Our parts and accessories are not original.



THERMOSTATS & COURROIES THERMOSTATS & 'V' BELTS

Tracteurs Tractors	Moteur Engine	Thermostat	Joint Gasket	Courroie de ventilateur Fan belt	Courroie compress. air Air compressor belt	
Moteurs 6 cylindres / 6 cylinder engines						
6190, 8110	1006.6T	30/143-18 (2485613, 1447384M1)	30/147-20 (3684A004, 3638700M1)	30/144-127 (D) (3582953M91)		
8120, 8130	1006.6T (Blue)			30/144-123 (D) (3616512M91)		
8120	1006.60T (Green)					
6260	1006.60	30/143-55 (2485C036, 4224639M1)	30/147-17 (3684N017, 4222851M1)	120 A Iska 1425mm 1410mm 30/144-245 (D) 30/144-243 (D) (3780606M91) (3780138M91)		30/144-221 (C) (3386214M1)
6270, 6280	1006.60T	Frein pneum. <i>Pneum. brake</i>	Frein pneum. <i>Pneum. brake</i>			
6290	1006.60T	30/143-60 (2485C034, 4224624M1)	30/147-18 (2415H492, 4223842M1)	30/144-243 (D) (3780138M91)		
8210, 8220	1006.60T	30/143-60 (2485C034, 4224624M1)	30/147-18 (2415H492, 4223842M1)	30/144-37 (D) (3617180M91)		
3680	612DS	79° 30/143-56 (3637650M1, V836015156)	30/147-29 (V836329632)			30/144-290 (C) (3581635M1)
3690	612DS			Sanjo - 1050mm 30/144-290 (C) (3581635M1)		
3670	620DS			Sanden - 1085mm 30/144-222 (C) (3389525M1)		
3690	634DS			1025mm 30/144-270 (C) (3712531M1)		
8140, 8150	620DS				30/144-129 (D) (3617184M91)	
8160	634DS					
8240	620DSRAE					30/144-222 (C) (3389525M1)
8240Xtra	620DWBAB					
8250, 8260	634DSBAE					1485mm 1015mm 30/144-37 (D) 30/144-256 (C) (3617180M91) (5016260M1)
8250Xtra	634DWBAB					
8260	634DSBIE					1525mm 918mm 30/144-36 (D) 30/144-241 (C) (3381364M91) (3778975M2)
8260Xtra	634DWBAB					30/144-221 (C) (3386214M1)
8170, 8180	645DSBIE					30/144-270 (C) (3712531M1)
8270, 8280	645DSBIE				30/147-30 (V836855603)	30/144-300 (E) (3777243M1, V836859262)
8270Xtra, 8280Xtra	645DSBAE					30/144-277 (E) (V685121905, V836864164)
						30/144-301 (C) (3582951M1)
						30/144-221 (C) (3386214M1)
				30/144-270 (C) (3712531M1)		

- (A) Courroie trapézoïdale simple / *Single wrapped wedge belt*
 (B) Paire de courroies trapézoïdales / *Pair of wrapped wedge belt*
 (C) Courroie crantée simple / *Single raw edge cogged belt*
 (D) Paire de courroies crantées / *Pair of raw edge cogged belts*
 (E) Courroie Multi V / *Multi V belt*

Les références des pièces sont indicatives.
 Nos pièces ne sont pas d'origine

Part numbers are quoted for reference purposes only.
 Our parts and accessories are not original.



THERMOSTATS & COURROIES
THERMOSTATS & 'V'BELTS

Tracteurs Tractors	Moteur Engine	Thermostat	Joint Gasket	Courroie de ventilateur Fan belt	Courroie compress. air Air compressor belt	
4 Moissonneuses-batteuses moteurs 4 cylindres / 4 cylinder engines combines						
186	A4.212	30/143-5 (2485659, 1446127M91)	30/147-14 (36862201, 4222011M1)	30/144-4 (A) (0070108, 893575M1)		
99, 187	A4.236	30/143-3 (2485666, 1446165M91)		Dynamo 1268mm 30/144-4 (A) (0070108, 893575M1)	Altern. 1320mm 30/144-207 (A) (1604464M1)	
206, 307 487, 506	A4.236 A4.248	30/143-5 (2485659, 1446127M91)		30/144-207 (A) (1604464M1)		
240 440	A4.236 A4.248					
8 Plot, 10 Plot, 16 Plot, 16, 330 430	A4.236 A4.248	30/143-3 (2485666, 1446165M91)	30/147-15 (36834152, 3641766M1)	1275mm 30/144-229 (D) (2614B650, 3637598M91)		
20	A4.248	78° ⇒ U792122H 30/143-4 (2485668, 1446222M91) 82° U792123H ⇒ 30/143-3 (2485666, 1446165M91)				
20XP	AT4.236	30/143-18 (2485613, 1447384M1)				
788	A4.270	30/143-3 (2485666, 1446165M91)	30/147-12 (36834169, 4222057M1)			
400, 410, 415	A4.300	30/143-4 (2485668, 1446222M91)		30/144-4 (A) (0070108, 893575M1)		
6 Moissonneuses-batteuses moteurs 4 cylindres / 4 cylinder engines combines						
24, 27 29	A6.354.4 AT6.354.4	30/143-18 (2485613, 1447384M1)	30/147-19 (36861757, 4222906M1)	Altern. 1350mm 30/144-204 (D) (2614B656, 1447407M91)	Ventil. / Fan 1332mm 30/144-268 (C) (D41999100)	
29XP, 31, 31XP	AT6.354.4			Altern. 1337mm 30/144-273 (D) (2614B655, 3639687M1)	Ventil. / Fan 1332mm 30/144-268 (C) (D41999100)	
500, 510, 515	A6.354	30/143-4 (2485668, 1446222M91)		30/144-4 (A) (0070108, 893575M1)		
507, 520, 525	A6.354			Dynamo 1268mm 30/144-4 (A) (0070108, 893575M1)	Altern. 1300mm 30/144-128 (D) (2614B652, 3637306M91)	
530, 535	A6.354.4	30/143-18 (2485613, 1447384M1)	30/147-19 (36861757, 4222906M1)	30/144-204 (D) (2614B656, 1447407M91)	30/144-220 (A) (3372217M1)	
530S	A6.354.4			Altern. 1350mm 30/144-204 (D) (2614B656, 1447407M91)	Ventil. / Fan 1235mm 30/144-219 (D) (3049010M91)	
800, 805, 810, 815	A6.354.4					30/144-216 (A) (3036278M1)

(A) Courroie trapézoïdale simple / Single wrapped wedge belt - (B) Paire de courroies trapézoïdales / Pair of wrapped wedge belt
 (C) Courroie crantée simple / Single raw edge cogged belt - (D) Paire de courroies crantées / Pair of raw edge cogged belts
 (E) Courroie Multi V / Multi V belt

Les références des pièces sont indicatives.
 Nos pièces ne sont pas d'origine

Part numbers are quoted for reference purposes only.
 Our parts and accessories are not original.

"THE RELIABLE SERVICE"

MF-150

Ed.1 (07/04)

THERMOSTATS & COURROIES THERMOSTATS & 'V'BELTS



Tracteurs Tractors	Moteur Engine	Thermostat	Joint Gasket	Courroie de ventilateur Fan belt	Courroie compress. air Air compressor belt		
Moissonneuses-batteuses moteurs 4 cylindres / 4 cylinder engines combines							
560, 565, 660, 665	AT6.354.4	30/143-18 (2485613, 1447384M1)	30/147-19 (36861757, 4222906M1)	Altern. Ventil. / Fan 1325mm 1235mm	30/144-220 (A) (3372217M1)		
820, 825, 830, 835, 840, 845	AT6.354.4			30/144-21 (C) (2614B154, 1687531M1)	30/144-219 (D) (3049010M91)	30/144-216 (A) (3036278M1)	
620, 625	A6.372			30/144-205 (D) (2614A149, 1447773M91)			
750	AT6.354.4 A6.372.4			Altern. Altern. 10x1318mm 13x1325mm	30/144-260 (D) (532779M92)	30/144-21 (C) (1687531M1)	
760, 850, 855, 860	AT6.354.4			Altern. Altern. 1325mm 1375mm	30/144-21 (C) (1687531M1)	30/144-259 (C) (525832M1)	
Tracteurs industriels moteurs 4 cylindres / 4 cylinder engine industrial tractors							
702	23C Diesel	30/143-2 (1894961M1)	30/147-13 (3910266M1)	30/144-1 (A) (826960M1)			
356	A4.203	30/143-4 (2485668, 1446222M91)	30/147-22 (36835442, 4223424M1)	1175mm 1200mm	30/144-2 (A) (0070078, 1851749M1)	30/144-3 (A) (0070106, 890982M1)	
30, 40B, 50, 302, 304, 356, 3165, 3303, 3305	AD4.203			30/144-3 (A) (0070106, 890982M1)			
50, 50B, 3303, 3305	A4.212	30/143-18 (2485613, 1447384M1)	30/147-14 (36862201, 4222011M1)	30/144-128 (D) (2614B652, 3637306M91)			
30D	A4.236			30/144-22 (C) (2614B659, 1447778M91)			
50	A4.236			30/144-6 (A) (1669923M1)			
50B, 50B MKII, 50D, 50H	A4.236			1300mm 1275mm	30/144-128 (D) (2614B652, 3637306M91)	30/144-229 (D) (2614B650, 3637598M91)	
50E 50EX	A4.236 A4.248			30/143-5 (2485659, 1446127M91)	35 A 1400mm	55 A 1325mm	30/144-6 (A) (1669923M1)
50HX, 60H	A4.248			30/144-229 (D) (2614B650, 3637598M91)			
50H-S 50HX-S, 60H-S	A4.236 A4.248						
50H-T 50HX-T	A4.236 A4.248	30/143-3 (2485666, 1446165M91)	30/147-15 (36834152, 3641766M1)	30/144-21 (C) (2614B154, 1687531M1)			
60HX, 60HX-T	AT4.236	30/143-18 (2485613, 1447384M1)		30/144-22 (C) (2614B659, 1447778M91)			
Fermec & Terex - Tracteurs industriels moteurs 4 cylindres / 4 cylinder engine industrial tractors							
750	1004.4 (Blue)	30/143-18 (2485613, 1447384M1)	30/147-15 (36834152, 3641766M1)	13x1375mm 13x1380mm			
760, 860, 860S, 860SE, 865, 960, 965	1004.4T (Blue)			30/144-223 (C) (3516195M2)	30/144-261 (C) (6100645M1)	960mm 30/144-297 (C) (3522468M3)	
750, 750B	1004.42 (Green)	30/143-55 (2485C036, 4224639M1)	30/147-16 (3683R009, 4222986M1)	Airco 10x1325mm	975mm		
760, 760B, 860, 860B, 860S, 860SE, 960, 960B, 965	1004.40T (Green)			30/144-224 (C) (3522485M3)		30/144-274 (C) (6102366M1)	

Les références des pièces sont indicatives.
Nos pièces ne sont pas d'origine

Part numbers are quoted for reference purposes only.
Our parts and accessories are not original.



THERMOSTATS & COURROIES THERMOSTATS & 'V'BELTS

Tracteurs Tractors	Moteur Engine	Thermostat	Joint Gasket	Courroie de ventilateur Fan belt	Courroie compress. air Air compressor belt	
 Chargeurs télescopiques / Telescopic handlers						
24	A4.236	30/143-5 (2485659, 1446127M91)	30/147-14 (36862201, 4222011M1)	30/144-212 (C) (2614B050, 1688988M1)		
24T	AT4.236	30/143-18 (2485613, 1447384M1)	30/147-15 (36834152, 3641766M1)			
8925, 8926	1004.4 (Blue)		30/147-21 (3687W017, 4222405M1)	30/147-18 (2415H492, 4223842M1)	1200mm 1180mm 30/144-233 (D) 30/144-255 (C) (2614B644, (4233305M1) 3639683M1)	
8925T, 8926T	1004.4T (Blue)					
8925, 8926	1004.42 (Green)	30/143-55 (2485C036, 4224639M1)	30/147-18 (2415H492, 4223842M1)	1235mm 1180mm 30/144-230 (D) 30/144-255 (C) (2614B647, (4233305M1) 3637978M91)		
8925T, 8926T	1004.40T (Green)					
8937, 8939	1004.4 (Blue)	30/143-18 (2485613, 1447384M1)	30/147-21 (3687W017, 4222405M1)	30/144-233 (D) (2614B644, 3639683M1)	30/144-279 (C) (4234437M1)	
8937T, 8939T	1004.4T (Blue)					
8937, 8939	1004.42 (Green)	30/143-55 (2485C036, 4224639M1)	30/147-18 (2415H492, 4223842M1)	30/144-255 (C) (4233305M1)		
8937T, 8939T	1004.40T (Green)					
 Tracteurs industriels moteurs 3 cylindres / 3 cylinder engine industrial tractors						
					Support Housing	
203, 205	A3.152	30/143-3 (2485666, 1446165M91)	30/147-12 (36834169, 4222057M1)	1175mm 1200mm 30/144-2 (A) 30/144-3 (A) (0070078, (0070106, 1851749M1) 890982M1)	30/146-3 (37766363, 746835M1)	
20, 40, 203, 205, 2135, 2203, 2205	AD3.152			30/144-3 (A) (0070106, 890982M1)		
20B (- 855893), 20D	AD3.152			1325mm 1300mm 30/144-5 (A) 30/144-128 (D) (1876670M1) (2614B652, 3637306M91)		
20B (855894 -), 20C, 20E, 30B	AD3.152			30/144-21 (C) (2614B154, 1687531M1)		
20F, 30E, 30H	AD3.152			35 A 55 A 1325mm 1175mm 30/144-21 (C) 30/144-29 (C) (2614B154, (2614B642, 1687531M1) 1693746M1)		
40E	AD3.152.4			30/144-29 (C) (2614B642, 1693746M1)		

- (A) Courroie trapézoïdale simple / Single wrapped wedge belt
 (B) Paire de courroies trapézoïdales / Pair of wrapped wedge belt
 (C) Courroie crantée simple / Single raw edge cogged belt
 (D) Paire de courroies crantées / Pair of raw edge cogged belts
 (E) Courroie Multi V / Multi V belt

Les références des pièces sont indicatives.
 Nos pièces ne sont pas d'origine

Part numbers are quoted for reference purposes only.
 Our parts and accessories are not original.



THERMOSTATS & COURROIES THERMOSTATS & 'V' BELTS

Tracteurs Tractors	Moteur Engine	Thermostat	Joint Gasket	Courroie de ventilateur Fan belt	Courroie compress. air Air compressor belt
Tracteurs industriels moteurs 4 cylindres / 4 cylinder engine industrial tractors					
702	23C Diesel	30/143-2 (1894961M1)	30/147-13 (3910266M1)	30/144-1 (A) (826960M1)	
356	A4.203	30/143-4 (2485668, 1446222M91)	30/147-22 (36835442, 4223424M1)	1175mm 1200mm 30/144-2 (A) 30/144-3 (A) (0070078, (0070106, 1851749M1) 890982M1)	
30, 40B, 50, 302, 304, 356, 3165, 3303, 3305	AD4.203			30/144-3 (A) (0070106, 890982M1)	
50, 50B, 3303, 3305	A4.212	30/143-18 (2485613, 1447384M1)	30/147-14 (36862201, 4222011M1)	30/144-128 (D) (2614B652, 3637306M91)	
30D	A4.236			30/144-22 (C) (2614B659, 1447778M91)	
50	A4.236			30/144-6 (A) (1669923M1)	
50B, 50B MKII, 50D, 50H	A4.236			1300mm 1275mm 30/144-128 (D) 30/144-229 (D) (2614B652, (2614B650, 3637306M91) 3637598M91)	
50E 50EX	A4.236 A4.248			35 A 55 A 1400mm 1325mm 30/144-6 (A) 30/144-21 (C) (1669923M1) (2614B154, 1687531M1)	
50HX, 60H	A4.248	30/144-229 (D) (2614B650, 3637598M91)			
50H-S 50HX-S, 60H-S	A4.236 A4.248		30/144-21 (C) (2614B154, 1687531M1)		
50H-T 50HX-T	A4.236 A4.248	30/143-3 (2485666, 1446165M91)	30/147-15 (36834152, 3641766M1)	30/144-22 (C) (2614B659, 1447778M91)	
60HX, 60HX-T	AT4.236	30/143-18 (2485613, 1447384M1)			
Fermeç & Terex - Tracteurs industriels moteurs 4 cylindres / 4 cylinder engine industrial tractors					
750	1004.4 (Blue)	30/143-18 (2485613, 1447384M1)	30/147-15 (36834152, 3641766M1)	13x1375mm 13x1380mm 30/144-223 (C) 30/144-261 (C) (3516195M2) (6100645M1)	960mm 30/144-297 (C) (3522468M3)
760, 860, 860S, 860SE, 865, 960, 965	1004.4T (Blue)				
750, 750B	1004.42 (Green)	30/143-55 (2485C036, 4224639M1)	30/147-16 (3683R009, 4222986M1)	Airco 10x1325mm 30/144-224 (C) (3522485M3)	975mm 30/144-274 (C) (6102366M1)
760, 760B, 860, 860B, 860S, 860SE, 960, 960B, 965	1004.40T (Green)				

- (A) Courroie trapézoïdale simple / Single wrapped wedge belt
 (B) Paire de courroies trapézoïdales / Pair of wrapped wedge belt
 (C) Courroie crantée simple / Single raw edge cogged belt
 (D) Paire de courroies crantées / Pair of raw edge cogged belts
 (E) Courroie Multi V / Multi V belt

Les références des pièces sont indicatives.
 Nos pièces ne sont pas d'origine

Part numbers are quoted for reference purposes only.
 Our parts and accessories are not original.



VENTILATEURS FAN BLADES

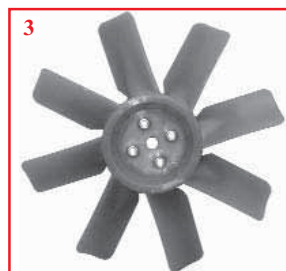
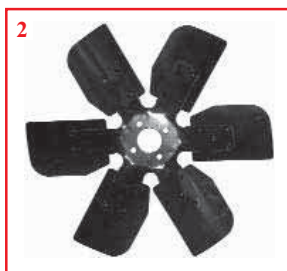

Tracteurs Tractors	Moteur Engine	Fig.	Acier Steel	Diamètre Diameter	Plastique Plastic	Fig.	
133, 135	A3.144	1	<i>Avant / Front</i> 30/145-6 (897051M1)	15 1/2" 394 mm 2 x 2 pales 2 x 2 blades			
133, 134, 135, 140, 145, 148, 150, 152, 154, 230, 233, 234, 235, 240, 244CF, 245, 250, 253 (Italy), 254, 255, 333, 334V, 340, 342, 350, 353, 354, 356CF, 550, 2205, 2210	AD3.152						
164T, 253 (UK), 263T (Italy), 264T, 352, 355, 360, 363, 364, 366CF	AT3.152.4						
243	903.27		<i>Arrière / Rear</i> 30/145-5 (897050M1)				
65, 155, 158, 158MKIII, 165, 260, 560, 765	AD4.203						
165, 174	A4.212		2	<i>Avant / Front</i> 30/145-7 (894729M1)			16" 406 mm 2 x 2 pales 2 x 2 blades
168, 168MKIII, 174, 175, 184, 265, 273, 274, 275, 283, 294S, 565, 575, 675	A4.236						
178, 185, 188, 194, 285, 293, 294S	A4.248						
174, 265, 273, 274, 275, 275E, 283, 284, 375E, 675	A4.236	3	<i>Arrière / Rear</i> 30/145-8 (894730M1)	16" 406 mm 8 pales 8 blades			
184, 194, 290, 290E, 293, 294, 390E, 394C, 394H, 590, 690	A4.248						
275E, 290E, 375E, 390E	A4.41						

COLLIERS DE DURITE HOSE CLIPS

Réf. Ref.	OEM	Ø utile / Adjustment		Réf. Ref.	OEM	Ø utile / Adjustment	
		mm	Pouce / Inch			mm	Pouce / Inch
70/2940-012	338612X1	9,5 - 12	3/8 - 1/2	70/2940-060	338617X1 3307666M91 3638398M1	45 - 60	1 3/4 - 2 3/8
70/2940-022	3019564X1	16 - 22	5/8 - 7/8	70/2940-070	338618X1 3307667M91 3638399M1 3638539M1	55 - 70	2 - 2 3/4
70/2940-025	3641405M1	18 - 25	3/4 - 1	70/2940-080	1440860X1	60 - 80	2 3/8 - 3 1/8
70/2940-030	3638805M1 4223580M1	22 - 30	7/8 - 1 1/8	70/2940-090	3010156X1	70 - 90	2 3/4 - 3 1/2
70/2940-035	338614X1	25 - 35	1 - 1 3/8	70/2940-100	338620X1 3010158X1	85 - 100	3 1/4 - 4
70/2940-040	338615X1 364125X1 394301X1 3638378M1	30 - 40	1 1/8 - 1 5/8	70/2940-120	338622X1 3010159X1	90 - 120	3 3/4 - 4 1/2
70/2940-050	338616X1 3307850M91 3638379M1	35 - 50	1 1/4 - 1 7/8	70/2940-140	338623X1 3010161X1	120 - 140	4 1/2 - 5 1/2
70/2940-055	376831X1	40 - 55	1 1/2 - 2 1/8	70/2940-160	338624X1 3010162X1	140 - 160	5 1/2 - 6 1/4



Les références des pièces sont indicatives.
Nos pièces ne sont pas d'origine

Part numbers are quoted for reference purposes only.
Our parts and accessories are not original.



RADIATEURS & DURITES
RADIATORS & HOSES



	1	2	3	4	5
Tracteurs Tractors	Radiateur Radiator	Bouchon Cap	Robinet Drain tap	Durite supérieure Top Hose	Durite inférieure Bottom hose
Tracteurs français, anglais & américains / French, UK & USA tractors					
TEA20, TED20, TEH20 85mm Petrol VO & LO	30/150-76 (9583)	30/151-1 (3638322M1)	30/55-2 (1851095M2, 31419M)	30/153-1 (1568)	30/154-113 (7126)
TEF 20C Diesel	30/150-1 (9617)			30/154-1 (2413)	
FE35 23C Diesel	30/150-2 (894357M92)			30/153-2 (827496M1)	30/154-2 (826988M1)
35 87mm Petrol	30/150-3 (894319M92)	30/151-2 (3475308M1)		30/154-6 (826775M1)	
35 A3.144 & A3.152				30/153-3 (890195M1)	30/154-3 (828147M1)
65, 765, 865				30/153-6 (827930M1)	30/154-6 (826775M1)
135 87mm Petrol	30/150-106 (897188M94)	7 Lbs LR 30/151-2 (3475308M1)		30/153-227 (897765M1)	30/154-227 (897764M1)
133, 135, 140, 145, 148, 152 (France) 135 (UK AD3.152 ⇒148524)	30/150-4 (1660499M92)	10 Lbs LR 30/151-3 (3637301M1)			30/154-4 (186968M1)
135 (UK AD3.152 148525 ⇒) 148 (UK)				30/153-11 (1869514M1)	30/154-5 (1860374M2)
155, 158, 158MKIII		30/151-2 (3475308M1)		30/153-111 (906502M1)	30/154-114 (906503M1)
165 (AD4.203)	30/150-9 (897358M4)			30/153-7 (898064M1)	30/154-7 (898065M1)
165 (UK A4.212)		30/151-3 (3637301M1)		30/153-9 (899144M1)	30/154-9 (898748M1)
165MKIII (France A4.212) 168	30/150-10 (885580M3)				
175	30/150-8 (894808M2)	30/151-2 (3475308M1)		30/153-8 (894793M1)	30/154-8 (898745M1)
178 (⇒ 724936)					
175S, 185	30/150-10 (885580M3)	30/151-3 (3637301M1)		30/153-9 (899144M1)	30/154-9 (898748M1)
178 (724937 ⇒), 188					30/154-10 (885563M1)
230, 240, 250	30/150-15 (1680547M92)	10 Lbs Rond / round 30/151-8 (1874445M93)			30/154-5 (1860374M2)
230, 240 (Direction hydrostatique / Hydrostatic steering) 253 (2WD)	30/150-90 (3599709M92)	10 Lbs SR 30/151-14 (180224M92)		30/153-11 (1869514M1)	30/154-228 (3599573M3)
235, 245, 255	30/150-89 (1660655M92)				30/154-5 (1860374M2)
253 (4WD)		30/151-14 (180224M92)			30/154-229 (3698937M1)

Les références des pièces sont indicatives.
Nos pièces ne sont pas d'origine

Part numbers are quoted for reference purposes only.
Our parts and accessories are not original.



RADIATEURS & DURITES
RADIATORS & HOSES

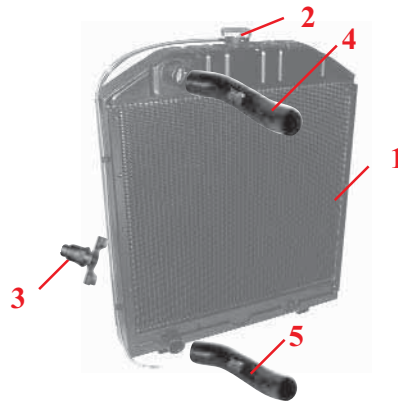

	1	2	3	4	5
Tracteurs Tractors	Radiateur Radiator	Bouchon Cap	Robinet Drain tap	Durite supérieure Top Hose	Durite inférieure Bottom hose
Tracteurs français, anglais & américains / French, UK & USA tractors					
260		30/151-8 (1874445M93)	30/55-2 (1851095M2, 31419M)	30/153-111 (906502M1)	30/154-114 (906503M1)
263 (2WD)				30/153-228 (3774344M1)	30/154-230 (3774635M1)
263 (4WD)		30/151-14 (180224M92)		30/153-11 (1869514M1)	30/154-231 (3774636M1)
265 275 (France 2WD)	30/150-12 (1876606M4)	30/151-8 (1874445M93)	30/55-2 (1851095M2, 31419M)	30/153-9 (899144M1)	30/154-9 (898748M1)
265 (South Africa) 275 (UK 2WD) 275E, 375E (A4.236)	30/150-16 (3820620M91)				30/153-130 (1692004M1)
275 (France 4WD)				30/153-229 (3820492M1)	
275 (UK 4WD 221522 ⇨)					30/153-230 (3820083M1)
275E, 375E (A4.41 2WD)				30/153-9 (899144M1)	
275E, 375E (A4.41 4WD)					30/153-130 (1692004M1)
285				30/150-12 (1876606M4)	30/153-230 (3820083M1)
290 (⇨ 387020)	30/150-16 (3820620M91)			30/153-66 (1669805M1)	30/154-66 (1669806M1)
290 (387021 ⇨) 290E, 390E (A4.248)				30/153-38 (1696559M1)	30/154-38 (1694711M3)
290E, 390E (A4.41)					30/153-39 (3611652M1)
298 (France)	30/150-91 (1680734M91)	30/153-231 (3700507M1)			
340, 342, 350, 352, 355, 360		30/151-14 (180224M92)	30/153-40 (3596204M1)	30/154-40 (1695562M1)	
362			30/153-41 (1695563M1)	30/154-41 (1695564M1)	
362N, 372N, 382N	30/150-92 (3700447M92)		30/153-232 (3614420M2)	30/154-232 (3614419M1)	
365, 375, 390, 390T, 398	30/150-19 (1695721M2)				
399 (A6.354.4 Marchepied / Footstep)					
399 (A6.354.4 Avec cabine / With cab)					
396, 399 (1006.6 (Blue))	30/150-93 (3614476M91)				

Les références des pièces sont indicatives.
Nos pièces ne sont pas d'origine

Part numbers are quoted for reference purposes only.
Our parts and accessories are not original.



"THE RELIABLE SERVICE"



RADIATEURS & DURITES
RADIATORS & HOSES

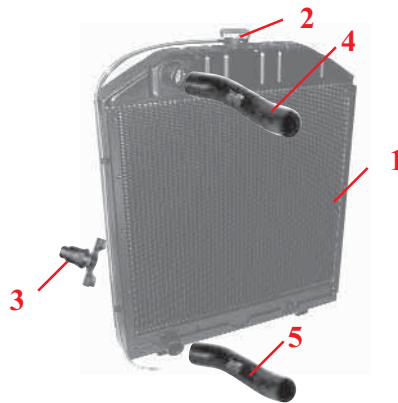

	1	2	3	4	5	
Tracteurs Tractors	Radiateur Radiator	Bouchon Cap	Robinet Drain tap	Durite supérieure Top Hose	Durite inférieure Bottom hose	
Tracteurs français, anglais & américains / French, UK & USA tractors						
550				30/153-11 (1869514M1)	30/154-11 (1662089M1)	
560				30/153-111 (906502M1)	30/154-114 (906503M1)	
565	30/150-12 (1876606M4)	30/151-8 (1874445M93)	30/55-2 (1851095M2, 31419M)		30/154-9 (898748M1)	
575	30/150-13 (1876608M3)				30/153-9 (899144M1)	
590	30/150-14 (1874964M94)					30/154-10 (885563M1)
592, 595, 595MKII				30/151-19 (531505M91)		30/153-64 (1671076M1)
675 (UK)	30/150-16 (3820620M91)			30/153-65 (1681509M1)	30/154-9 (898748M1)	
675 (France 4WD) 690 Platform						30/154-10 (885563M1)
690	30/150-94 (1680599M92)	30/151-14 (180224M92)	30/55-2 (1851095M2, 31419M)			
698, 1004				30/153-66 (1669805M1)	30/154-66 (1669806M1)	
698T, 1004T	30/150-91 (1680734M91)					
699				30/153-68 (1692871M1)		
1080 (France)		30/151-19 (531505M91)		30/153-64 (1671076M1)	30/154-64 (520309M91)	
1080 (USA) 1085				30/153-233 (522078M1)		
1250				30/153-64 (1671076M1)		
2620, 2720 2640, 2680 (S134208 ⇨ S217212)		30/151-14 (180224M92)		30/153-69 (3052205M1)	30/154-69 (3040882M92)	
2640, 2680 (S217213 ⇨) 2625, 2645, 2685, 2725		30/151-15 (968816M2)				
3050, 3060, 3065 (⇨ B246028)	30/150-81 (3382797M91)			30/153-43 (3382976M2)	30/154-43 (3382984M1)	
3050, 3060, 3065 (B246029 ⇨)	30/150-58 (3618630M92)	30/151-14 (180224M92)			30/154-233 (3618643M1)	
3050HV, 3060HV, 3065HV				30/153-143 (3618474M3)	30/154-234 (3618477M4)	
3065S (⇨ B355024)	30/150-83 (3618290M91)	30/151-15 (968816M2)		30/153-43 (3382976M2)	30/154-43 (3382984M1)	
3065S (B355025 ⇨)	30/150-57 (3618632M92)	30/151-14 (180224M92)			30/154-233 (3618643M1)	

Les références des pièces sont indicatives.
Nos pièces ne sont pas d'origine

Part numbers are quoted for reference purposes only.
Our parts and accessories are not original.



"THE RELIABLE SERVICE"



RADIATEURS & DURITES
RADIATORS & HOSES



Tracteurs Tractors	1 Radiateur Radiator	2 Bouchon Cap	3 Robinet Drain tap	4 Durite supérieure Top Hose	5 Durite inférieure Bottom hose
Tracteurs français, anglais & américains / French, UK & USA tractors					
3070 (⇒ 07/93)	30/150-82 (3382795M93)	30/151-15 (968816M2)		30/153-44 (3382977M1)	30/154-44 (3384380M1)
3070 (07/93 ⇒)	30/150-59 (3618628M92)	30/151-14 (180224M92)		30/153-134 (3619057M1)	30/154-245 (3618642M1)
3075					30/154-133 (3619055M1)
3080, 3090	30/150-82 (3382795M93)	30/151-15 (968816M2)		30/153-45 (3387747M1)	30/154-45 (3382985M1)
3085, 3095, 3120, 3120T (⇒ B249025) 3115 (⇒ 07/93)					30/154-236 (3582909M1)
3085, 3095, 3120, 3120T (B249026 ⇒) 3115 (07/93 ⇒)	30/150-59 (3618628M92)	30/151-14 (180224M92)		30/153-132 (3582179M2)	30/154-237 (3618641M1)
3125 (⇒ B249037) 3140					30/154-238 (3581959M1)
3125 (B249038 ⇒)	30/150-60 (3618626M92)	30/151-14 (180224M92)		30/153-131 (3582178M1)	30/154-239 (3618640M1)
3610, 3630, 3650					30/154-69 (3040882M92)
3635 (⇒ B249037), 3645 (⇒ B249039), 3655 (⇒ B062028), 3660		30/151-15 (968816M2)		30/153-131 (3582178M1)	30/154-238 (3581959M1)
3655 (B062029 ⇒ B284012)					30/154-131 (3619026M1)
3635 (B249038 ⇒), 3645 (B249040 ⇒), 3655 (B284013 ⇒)	30/150-61 (3619008M92)			30/153-234 (3389736M1)	30/154-130 (3580014M1)
3670, 3680, 3690					
4215, 4220				Ø 32mm 30/153-140 (3811653M1)	30/154-139 (3811654M1)
4215, 4220 4315, 4320 (Avec cabine / With cab)				Ø 37mm 30/153-235 (3817514M1)	
4225, 4235, 4240, 4245, 4255 (Blue engines - Marchepied / Footstep) Avec cabine / With Cab (⇒ J01274)	30/150-129 (3810188M92)	30/151-14 (180224M92)		30/153-138 (3807508M1)	30/154-137 (3807509M1)
4225, 4235, 4240, 4245, 4255 (Blue engines) Avec cabine / With Cab (J01275 ⇒ K37008)					30/154-240 (3818834M2)
4225, 4235, 4240, 4245, 4255 (Blue engines) Avec cabine / With Cab (K37009 ⇒)					30/154-241 (3820313M1)
4225, 4235, 4240, 4245, 4255 (Green engines) 4325, 4335, 4345, 4355					30/154-136 (3801168M1)

Les références des pièces sont indicatives.
Nos pièces ne sont pas d'origine

Part numbers are quoted for reference purposes only.
Our parts and accessories are not original.



"THE RELIABLE SERVICE"



RADIATEURS & DURITES
RADIATORS & HOSES

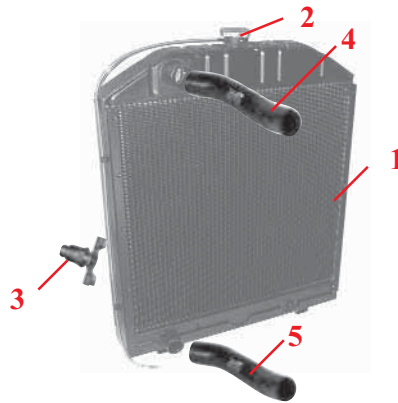

	1	2	3	4	5	
Tracteurs Tractors	Radiateur Radiator	Bouchon Cap	Robinet Drain tap	Durite supérieure Top Hose	Durite inférieure Bottom hose	
Tracteurs français, anglais & américains / French, UK & USA tractors						
4225HV, 4235HV, 4245HV, 4255HV (Blue engines)		30/151-14 (180224M92)		30/153-139 (3809505M1)	30/154-138 (3810344M1)	
4225HV, 4235HV, 4245HV, 4255HV (Green engines) 4325HV, 4335HV, 4345HV, 4355HV						30/154-136 (3801168M1)
4260, 4270, 4360, 4370	30/150-110 (3808159M2)				30/153-137 (3801167M1)	
4265, 4365					30/153-138 (3807508M1)	
6110, 6120, 6130, 6140	30/150-58 (3618630M92)				30/153-133 (3619056M1)	30/154-132 (3619054M1)
6110HV, 6120HV, 6130HV, 6140HV					30/153-143 (3618474M3)	30/154-134 (3777203M1)
6150	30/150-59 (3618628M92)				30/153-134 (3619057M1)	30/154-133 (3619055M1)
6160, 6170, 6180					30/153-132 (3582179M2)	30/154-237 (3618641M1)
6190	30/150-61 (3619008M92)				30/153-131 (3582178M1)	30/154-131 (3619026M1)
6235, 6245, 6255, 6260						
6265, 6270, 6280, 6290	30/150-128 (3781116M1)				30/153-138 (3807508M1)	30/154-136 (3801168M1)
6235HV, 6245HV, 6255HV					30/153-139 (3809505M1)	
8110, 8130 8120 (Blue engines)	30/150-61 (3619008M92)					
8120 (Green engines)					30/153-131 (3582178M1)	30/154-131 (3619026M1)
8140, 8150, 8160					30/153-135 (3713189M2)	30/154-130 (3580014M1)
8170, 8180					30/153-136 (3777260M2)	30/154-135 (3778088M1)

Les références des pièces sont indicatives.
Nos pièces ne sont pas d'origine

Part numbers are quoted for reference purposes only.
Our parts and accessories are not original.



"THE RELIABLE SERVICE"



RADIATEURS & DURITES
RADIATORS & HOSES

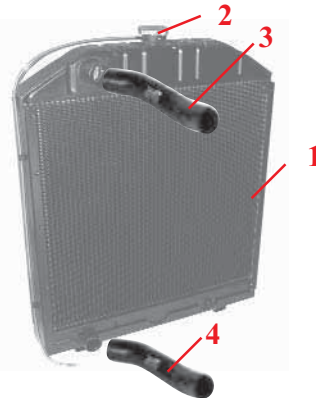

Robinet / Drain tap

30/55-2
(1851095M2,
31419M)



Tracteurs Tractors	1 Radiateur / Radiator		2	3	4	
	Tempéré Temperate	Tropical	Bouchon Cap	Durite supérieure Top Hose	Durite inférieure Bottom hose	
IT Tracteurs italiens / Italian tractors						
134C, 154, 154C	30/150-49 (1824627M93)		30/151-29 (1824628M91)	30/153-114 (1824633M1)	30/154-209 (1824634M2)	
134V, 154V				30/153-241 (3530346M1)	30/154-249 (3530397M1)	
154F (1er modèles / Early)	30/150-112 (3660549M92)			30/153-236 (3303316M1)	30/154-209 (1824634M2)	
154F (Derniers modèles / Late)						30/154-249 (3530397M1)
154S (1er modèles / Early)						30/154-209 (1824634M2)
154S (Derniers modèles / Late)						30/154-242 (3308585M1)
164TF, 164TS	30/150-112 (3660549M92)	30/150-113 (3660548M92)				30/153-241 (3530346M1)
164TV						
174, 174C, 184, 194, 194C (1er modèles / Early)	30/150-49 (1824627M93)			30/153-114 (1824633M1)	30/154-213 (1824637M1)	
174, 174C, 184, 194, 194C (Derniers modèles / Late)					30/154-210 (1424533M2)	
174F, 184F	30/150-114 (3308187M99)	30/150-113 (3660548M92)		30/153-236 (3303316M1)	30/154-243 (3550411M2)	
174S, 184S (1er modèles / Early)						30/154-210 (1424533M2)
174S, 184S (Derniers modèles / Late)					30/154-243 (3550411M2)	
174V, 194S						
194F	30/150-114 (3308187M99)	30/150-115 (3380480M99)				
233, 253 (1er modèles / Early)	30/150-49 (1824627M93)			30/153-114 (1824633M1)	30/154-209 (1824634M2)	
234C, 234S, 254, 254C, 254S					30/154-242 (3308585M1)	
233, 253 (Derniers modèles / Late)	30/150-116 (3307942M97)	30/150-117 (3380481M99)			30/154-210 (1424533M2)	
234CF, 244CF, 254CF, 263T, 264T, 264TCF, 264TS						
273, 274C, 274SK, 283, 284, 293, 294 (1er modèles / Early)	30/150-49 (1824627M93)				30/154-243 (3550411M2)	
274, 274S						
273, 274C, 274SK, 283, 284, 293, 294 (Derniers modèles / Late)	30/150-116 (3307942M97)	30/150-117 (3380481M99)		30/154-211 (1427275M1)		
274CF, 294C				30/154-244 (3308583M1)		
284S	30/150-49 (1824627M93)		30/153-218 (1427274M1)			
294S (1er modèles / Early)						
294S (Derniers modèles / Late)	30/150-116 (3307942M97)					

Les références des pièces sont indicatives.
Nos pièces ne sont pas d'origine

Part numbers are quoted for reference purposes only.
Our parts and accessories are not original.



RADIATEURS & DURITES
RADIATORS & HOSES

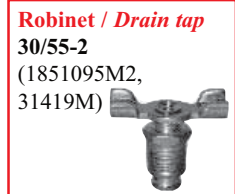
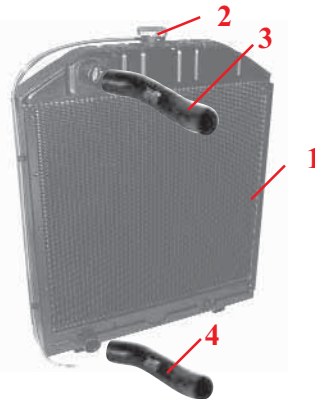

Tracteurs Tractors	1		2	3	4
	Tempéré Temperate	Tropical	Bouchon Cap	Durite supérieure Top Hose	Durite inférieure Bottom hose
IT Tracteurs italiens / Italian tractors					
333, 353, 353LX, 353S	Curli 30/150-116 (3307942M97) Fira 30/150-125 (3546937M91)		30/151-29 (1824628M91)	30/153-114 (1824633M1)	30/154-242 (3308585M1)
334V				30/153-241 (3530346M1)	30/154-249 (3530397M1)
354AQ, 354F, 354FQ, 354S, 354SQ, 354 AP/FP/GE/SP 354, 3210 FP(X)/GE(X)/SP(X) 356CF	30/150-112 (3551641M92, 3557706M93, 3660549M92)			30/153-236 (3303316M1)	30/154-242 (3308585M1)
354V (06/94 ⇔)				30/153-241 (3530346M1)	30/154-249 (3530397M1)
354 VQ (07/94 ⇔) 354V (Marchepied / Footstep)				30/153-237 (3552207M1)	30/154-246 (3550890M1)
363, 363LX, 363S, 364CF	Curli 30/150-116 (3307942M97) Fira 30/150-125 (3546937M91)	30/150-117 (3308481M99)		30/153-114 (1824633M1)	30/154-242 (3308585M1)
364AQ, 364F, 364FQ, 364S, 364SQ, 364 AP/FP/GE/SP, 366CF	30/150-112 (3551641M92, 3557706M93, 3660549M92)	30/150-113 (3551414M93, 3557707M94, 3660548M92)		30/153-236 (3303316M1)	30/154-249 (3530397M1)
364V (06/94 ⇔)				30/153-241 (3530346M1)	
364 VQ (07/94 ⇔) 364V (Marchepied / Footstep)				30/153-237 (3552207M1)	
367CF	30/150-114 (3308187M99)			30/153-236 (3303316M1)	
373, 373LX, 373S, 376C, 376CF, 376XCF, 383, 383LX, 383S	Curli 30/150-116 (3307942M97) Fira 30/150-125 (3546937M91)	30/150-117 (3308481M99)	30/153-114 (1824633M1)	30/154-243 (3550411M2)	

Les références des pièces sont indicatives.
Nos pièces ne sont pas d'origine

Part numbers are quoted for reference purposes only.
Our parts and accessories are not original.



"THE RELIABLE SERVICE"



RADIATEURS & DURITES
RADIATORS & HOSES

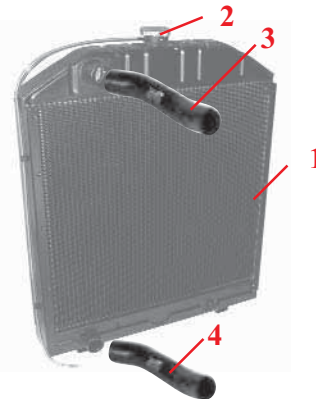

Robinet / Drain tap

30/55-2
(1851095M2,
31419M)



Tracteurs Tractors	1		2	3	4
	Tempéré Temperate	Tropical	Bouchon Cap	Durite supérieure Top Hose	Durite inférieure Bottom hose
IT Tracteurs italiens / Italian tractors					
374F, 374S, 384F, 384S	30/150-112 (3551641M92, 3557706M93, 3660549M92)	30/150-113 (3551414M93, 3557707M94, 3660548M92)	30/151-29 (1824628M91)	30/153-236 (3303316M1)	30/154-243 (3550411M2)
374V (⇒ B28075)				30/153-238 (3530396M1)	
374V (B28076 ⇒)	30/150-114 (3308187M99)				
374, 384 AP/FP/GE/SP 374, 384 AQ/FQ/SQ (⇒ 02/05/97)					
374, 384 AQ/FQ/SQ (03/05/97 ⇒) 374, 3220 AP(X)/FP(X)/GE(X)/SP(X) (Blue engines) 384, 3225 AP(X)/FP(X)/GE(X)/SP(X)	30/150-113 (3551414M93, 3557707M94, 3660548M92)				
374, 3220 AP(X)/FP(X)/GE(X)/SP(X) (Green engines)				30/154-126 (3649081M1)	
374VQ, 384VQ 374V, 384V (Marchepied / Footstep)	30/150-113 (3551414M93, 3557707M94, 3660548M92)	Curli 30/150-115 (3658635M92) Fira 30/150-126 (3557708M94)		30/153-236 (3303316M1)	30/154-243 (A) (3550411M2) 30/154-247 (B) (3551425M91)
377	Sans airco <i>Without A/C</i> Curli 30/150-116 (3307942M97)	30/150-117 (3308481M99)			
387, 397	Fira 30/150-125 (3546937M91) Avec airco <i>With A/C</i> 30/150-117 (3308481M99)	Sans airco <i>Without A/C</i> Curli 30/150-117 (3308481M99) Avec airco <i>With A/C</i> Fira 30/150-119 (3547503M95)			30/154-243 (3550411M2)

(A) Climat tempéré sans airco / *Temperate climate without A/C*

(B) Climat tempéré avec airco ou climat tropical avec ou sans airco / *Temperate climate with A/C or tropical climate with and without A/C*

Les références des pièces sont indicatives.
Nos pièces ne sont pas d'origine

Part numbers are quoted for reference purposes only.
Our parts and accessories are not original.



RADIATEURS & DURITES
RADIATORS & HOSES

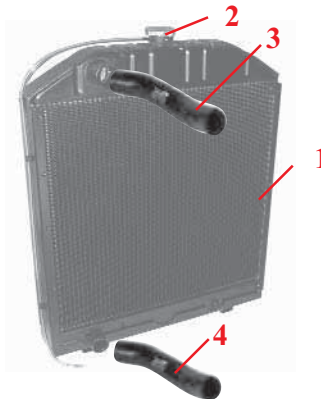

Robinet / Drain tap
30/55-2
(1851095M2,
31419M)



Tracteurs Tractors	1		2	3	4
	Tempéré Temperate	Tropical	Bouchon Cap	Durite supérieure Top Hose	Durite inférieure Bottom hose
IT Tracteurs italiens / Italian tractors					
393, 393LX, 393S, 394C, 396C, 396CF	Curli 30/150-116 (3307942M97) Fira 30/150-125 (3546937M91)	30/150-117 (3308481M99)	30/151-29 (1824628M91)	30/153-114 (1824633M1)	
393TLX, 396CT	30/150-119 (3547503M95)			30/153-239 (3545853M1)	30/154-243 (3550411M2)
394F, 394H, 394S 394AQ, 394FQ, 394SQ (⇒ 02/05/97)	30/150-114 (3308187M99)	30/150-115 (3308480M99)		30/153-236 (3303316M1)	30/154-126 (3649081M1)
394 AP/FP/GE/SP	30/150-113 (3551414M93, 3557707M94, 3660548M92)	Curli 30/150-115 (3658635M92)			
394, 3235 AP(X)/FP(X)/GE(X)/SP(X) (Blue engines)		Fira 30/150-126 (3557708M94)		30/154-243 (3550411M2)	
394, 3235 AP(X)/FP(X)/GE(X)/SP(X) (Green engines)				30/153-239 (3545853M1)	30/154-243 (3550411M2)
394TAQ	30/150-120 (3648755M91)				
397T, 1007	Sans airco / Without A/C 30/150-121 (3534145M91)			30/153-240 (3534550M1)	30/154-248 (3534528M1)
	Avec airco / With A/C 30/150-122 (3650779M91)				
1014 (1er modèles / Early)	30/150-123 (3304168M92)			30/153-219 (3301097M1)	30/154-115 (3301095M1)
1014 (Derniers modèles / Late) 1024				30/154-212 (1425333M1)	
1104			30/153-113 (1822671M1)	30/154-215 (1424534M1)	
1114, 1134	30/150-124 (3304174M92)		30/153-112 (1425332M1)	30/154-212 (1425333M1)	

Les références des pièces sont indicatives.
Nos pièces ne sont pas d'origine

Part numbers are quoted for reference purposes only.
Our parts and accessories are not original.



"THE RELIABLE SERVICE"



RADIATEURS & DURITES
RADIATORS & HOSES



	1	2	3	4	5
Tracteurs Tractors	Radiateur Radiator	Bouchon Cap	Robinet Drain tap	Durite supérieure Top Hose	Durite inférieure Bottom hose
Tracteurs industriels / Industrial tractors					
20B, 20E	30/150-15 (1680547M92)		30/55-2 (1851095M2, 31419M)	30/153-11 (1869514M1)	30/154-5 (1860374M2)
20D					30/154-11 (1662089M1)
20F, 30E, 30H	30/150-15 (1680547M92)				30/154-250 (3505655M1)
30D	30/150-12 (1876606M4)			30/153-9 (899144M1)	30/154-9 (898748M1)
40	30/150-4 (1660499M92)	7 Lbs LR 30/151-2 (3475308M1) 10 Lbs LR 30/151-3 (3637301M1)		30/153-11 (1869514M1)	30/154-4 (186968M1)
40E	30/150-15 (1680547M92)	30/151-8 (1874445M93)			30/154-250 (3505655M1)
50 (AD4.203)	30/150-9 (897358M4)	30/151-2 (3475308M1)		30/153-7 (898064M1)	30/154-7 (898065M1)
50 (A4.212 & A4.236) 50B (UK ⇒ L5373)		30/151-3 (3637301M1)		30/153-9 (899144M1)	30/154-9 (898748M1)
50B (France ⇒ L5373)	30/150-10 (885580M3)				
50B (L5374 ⇒), 50BMKII, 50D					
50E, 50EX	30/150-16 (3820620M91)	30/151-8 (1874445M93)	30/153-37 (535203M1)		
50H, 50H-S, 50HX, , 50HX-S, 60H, 60H-S		30/151-3 (3637301M1)	30/153-130 (1692004M1)		
			30/153-37 (535203M1)		

Les références des pièces sont indicatives.
Nos pièces ne sont pas d'origine

Part numbers are quoted for reference purposes only.
Our parts and accessories are not original.



DURITES DE RADIATEUR
RADIATOR HOSES

30/153-1 	30/153-2 	30/153-3 	30/153-6 	30/153-7 
30/153-8 	30/153-9 	30/153-11 	30/153-37 	30/153-38 
30/153-39 	30/153-40 	30/153-41 	30/153-43 	30/153-44 
30/153-45 	30/153-64 	30/153-65 	30/153-66 	30/153-68 
30/153-111 	30/153-112 	30/153-113 	30/153-114 	30/153-130 
30/153-131 	30/153-132 	30/153-133 	30/153-134 	30/153-135 
30/153-136 	30/153-137 	30/153-138 	30/153-139 	30/153-140 
30/153-143 	30/153-218 	30/153-219 	30/153-227 	30/153-228 
30/153-229 	30/153-230 	30/153-231 	30/153-232 	30/153-233 

Les références des pièces sont indicatives.
Nos pièces ne sont pas d'origine

Part numbers are quoted for reference purposes only.
Our parts and accessories are not original.



"THE RELIABLE SERVICE"



**DURITES DE RADIATEUR
RADIATOR HOSES**





























30/153-234 	30/153-235 	30/153-236 	30/153-237 	30/153-238 
30/153-239 	30/153-240 			
30/154-1 	30/154-2 	30/154-3 	30/154-4 	30/154-5 
30/154-6 	30/154-7 	30/154-8 	30/154-9 	30/154-10 
30/154-11 	30/154-38 	30/154-39 	30/154-40 	30/154-41 
30/154-43 	30/154-44 	30/154-45 	30/154-64 	30/154-66 
30/154-69 	30/154-113 	30/154-114 	30/154-115 	30/154-130 
30/154-131 	30/154-132 	30/154-133 	30/154-134 	30/154-135 
30/154-136 	30/154-137 	30/154-138 		

Les références des pièces sont indicatives.
Nos pièces ne sont pas d'origine

Part numbers are quoted for reference purposes only.
Our parts and accessories are not original.



**DURITES DE RADIATEUR
RADIATOR HOSES**

30/154-139 	30/154-208 	30/154-209 	30/154-210 	30/154-211 
30/154-212 	30/154-213 	30/154-215 	30/154-227 	30/154-228 
30/154-230 	30/154-231 	30/154-232 	30/154-233 	30/154-234 
30/154-236 	30/154-237 	30/154-238 	30/154-239 	30/154-240 
30/154-241 	30/154-242 	30/154-243 	30/154-244 	30/154-245 
30/154-246 	30/154-247 	30/154-248 		



Les références des pièces sont indicatives.
Nos pièces ne sont pas d'origine



Part numbers are quoted for reference purposes only.
Our parts and accessories are not original.



**COLLECTEURS D'ÉCHAPPEMENT
EXHAUST MANIFOLDS**



Tracteurs Tractors	Moteur Engine	Fig.	Collecteur Manifold	Joint Gasket
35, 133, 135 35	A3.144 A3.152	1	30/65-1 (37781251, 731267M1)	30/66-1 (4223501M1)
133, 134, 135, 140, 145, 152, 154, 233, 234, 244CF, 253(Italy), 254, 333, 334V, 353, 354, 356CF, 2205, 3210 <i>Sortie / Outlet 180°</i>	AD3.152	2	30/65-2 (37781341, 734874M1)	30/66-2 (4222050M1)
133, 135, 140, 148, 152, 230, 235, 240, 245, 250, 255, 340, 342, 350  20B, 20E, 20F, 30E, 30H <i>Sortie / Outlet 90°</i>	AD3.152	3	30/65-3 (37781571, 740221M1)	
165, 174 168, 174, 175, 184, 273, 274, 283, 284, 367CF, 373, 374, 376C, 383, 384, 3220 178, 194, 293, 294, 393, 394, 396C, 3235 <i>Sortie / Outlet 180°</i>  30D, 50, 50B, 50BMKII, 50D/E/EX/H/HS/HX/HXS, 60H/HS	A4.212 A4.236 A4.248	4	30/65-5 (37781333, 735826M1)	
165 168, 175, 265, 275, 275E, 362, 362N, 372N, 375E, 575 178, 188, 290, 382N, 390E, 590 <i>Sortie / Outlet 90°</i>  16, 16Plot, 20, 487, 506	A4.212 A4.236 A4.248	5	30/65-7 (37781781, 736206M1)	30/66-3 (3640556M1)
265, 274SK, 275, 284S, 377, 387, 565, 575 285, 290, 294S, 397, 590	A4.236 A4.248	6	30/65-6 (37781051, 741764M1)	

		
30/66-1 4223501M1, 36833167 <i>Moteur A3.152 Engine</i>	30/66-2 4222050M1, 36862143 <i>Moteur AD3.152 Engine</i>	30/66-3 3640556M1, 36862189 <i>Moteur A4.212, A4.236, A4.248, AT4.236, 1004.4, 1004.4T Engine</i>



Les références des pièces sont indicatives.
Nos pièces ne sont pas d'origine

*Part numbers are quoted for reference purposes only.
Our parts and accessories are not original.*



**COUDES D'ÉCHAPPEMENT
EXHAUST ELBOW**



Tracteurs Tractors	Fig.	Coude Elbow	Joint Gasket	A	B	C
TEA20, TED20, 35 (85mm Petrol)	1	30/164-1 (640010M1)	30/167-1 (825003M1)	39	67	50.7
TEF20, FE35 (Diesel)	2	30/164-2 (824245M1)				
35, 135 (87mm Petrol)	3	30/164-3 (899130M1)				
35, 133, 135, 140, 145, 152	4	30/164-4 (898011M1)	30/167-2 (4222475M1)	33	67	50
65, 165, 260, 765	5	30/164-5 (897914M1)				
165, 175, 178	6	30/164-6 (897913M1)	30/167-3 (3638761M1)	45	71	54
65, 165, 168, 175, 178, 185, 188, 265, 275, 290, 362, 372N, 565, 575, 590  30D	7	30/164-7 (1862807M1)	30/167-4 (194742M1)	55	80	54
135, 148, 230, 235, 240, 245, 250, 255, 340, 342, 350, 550  20B, 20D, 20E	8	30/164-8 (1693855M1)	30/167-2 (4222475M1)	42	66	50.7

Les références des pièces sont indicatives.
Nos pièces ne sont pas d'origine

Part numbers are quoted for reference purposes only.
Our parts and accessories are not original.



**ECHAPPEMENTS
SILENCERS**

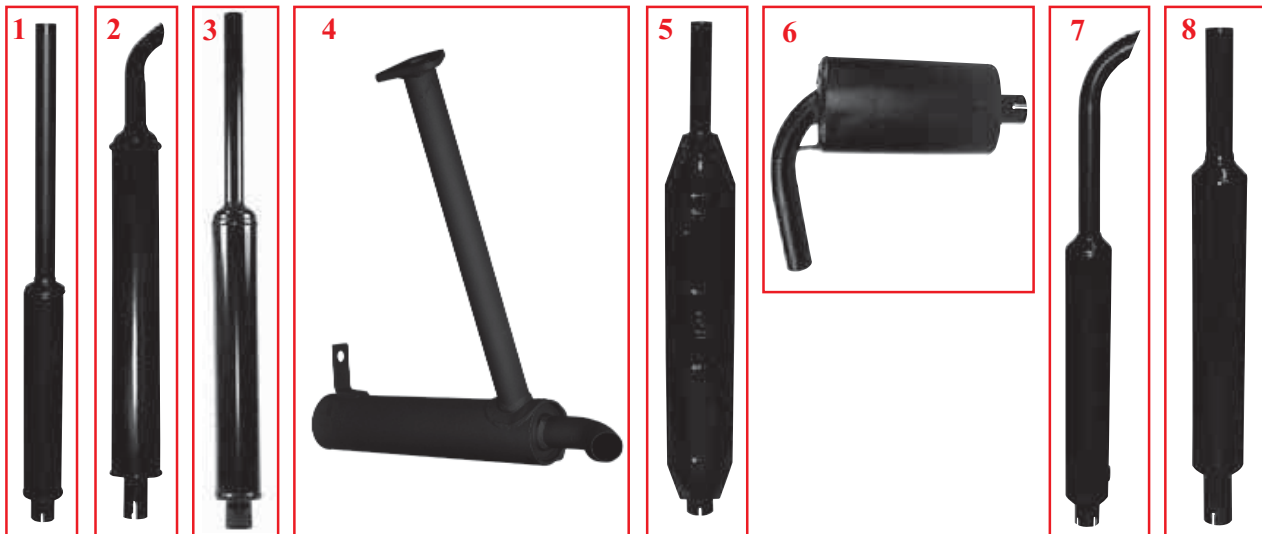

Tracteurs Tractors	Fig.	Réf. Ref.	OEM	A	B	C	D	E	F	G	H	Description
TE20, 35, 135, 148, 152 240 (⇒ 522353) 250, 235, 245, 550 20B, 20D, 20E	1	30/165-1	1683796M3	38	51.5	530	470	55	75			Peint Painted
		30/165-1S	894291M2									Emaillé Enamelled
TE20, 35, 35X, 37, 133, 135, 140, 145, 148, 235, 245, 250, 255	2	30/165-6	890476M93 180364M92	36	39	400	570	70	80			Peint Painted
65, 134C, 154C, 155, 158, 165, 168, 174C, 175S, 178, 184, 185, 188, 194, 565, 575 20F, 30E, 30H, 40, 50 /B/BMKII/D/E/EX/H/HS, 50HX/HXS, 60H/HS	3	30/165-2	898228M94	39	54	480	600	70	95			Peint Painted
		30/165-2S										Emaillé Enamelled
133, 135, 140, 145, 152	4	30/165-157	969353M1	42		127	548		82			Peint Painted
134, 154, 164, 174, 184, 194, 233, 234, 244CF, 254, 264, 274, 294, 333, 334V, 353, 354, 363, 364, 373, 374, 376C, 377, 383, 384, 387, 393, 394, 396, 397	5	30/165-145	3530335M91	42	55	275	800	50	100 x 130			Emaillé Enamelled
154F, 174F, 184F, 194F 354, 364, 374, 384, 394 AP/F/FP/GE/S/SP 3210, 3220, 3225, 3235	6	30/165-146	3531689M92	43	50	300	495	60	95 x 165			Peint Painted
154 /F/S, 174 /F/S, 184 /S, 194 /C/F/S, 234 /C/CF/S, 254 /C/CF/S, 263T, 264 /T/TCF/TS, 274 /C/CF/S/SK, 284 /S, 294 /C/S	7	30/165-147	1427799M94	46	55	460	600	65	102			Peint Painted
260, 265, 275, 285, 290, 560, 565, 575, 590 Montage au dessus du capot Up the bonnet fitting	8	30/165-28	1672994M93 1894207M91	52	55	480	460	100	112			Peint Painted
265, 275, 290, 375, 390, 362N, 372N, 382N, 565, 575, 590, 30D Montage latéral / Side fitting	1	30/165-27	3821782M91	52	55	500	455	415	112			Peint Painted
		30/165-27PB										Emaillé Enamelled
		30/165-162		52	55	500	455	415	112			Peint Painted

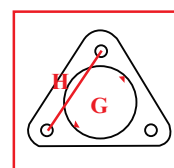
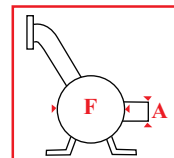
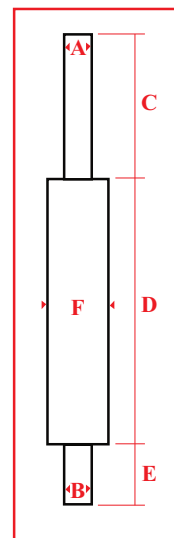

Les références des pièces sont indicatives.
Nos pièces ne sont pas d'origine

Part numbers are quoted for reference purposes only.
Our parts and accessories are not original.



"THE RELIABLE SERVICE"



**ECHAPPEMENTS
SILENCERS**

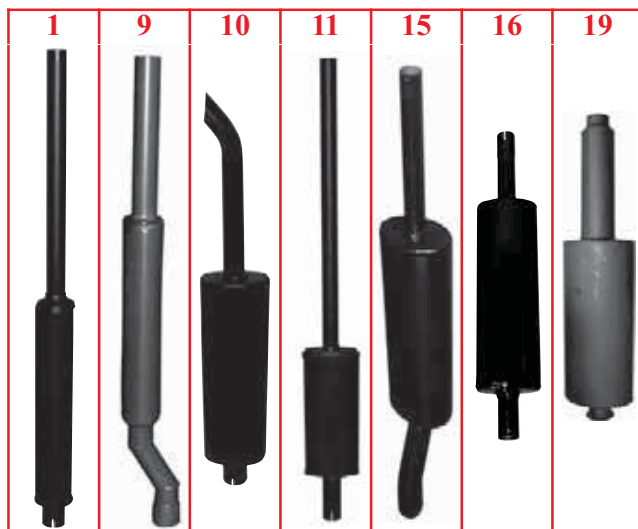

Tracteurs Tractors	Fig.	Réf. Ref.	OEM	A	B	C	D	E	F	G	H	Description
298, 595, 698, 1080	9	30/165-120	3600200M91	57	70	400	500	320	100 x 195			Peint Painted
298, 699	10	30/165-155	1693294M1	55	75	490	610	75	100 x 195			Emaillé Enamelled
340, 342, 350, 352, 355, 360, 362, 362N, 372N, 382N	11	30/165-26	3821781M91	42	51.5	820	380	150	80 x 160			Peint Painted
365, 375 390 (B18009 ⇒)	12	30/165-110	1694961M5	55			430	150				Peint Painted
390 (⇒ B18008) 390T, 398	13	30/165-109	1694963M5	63			402	150				Peint Painted
396, 399	14	30/165-108	1694965M6	63			430	150				Peint Painted
675, 690	1	30/165-29	1680877M92	51.5	55	710	455	175	112			Peint Painted
698	15	30/165-156	1680529M92	55	72	460	610	310				Peint Painted
1014, 1024	16	30/165-70	3301158M94	68	70	490	540	70	130 x 210			Peint Painted
1114	17	30/165-111	1427504M95	73	70	120	570	230	120 x 230			Emaillé Enamelled
1134	18	30/165-112	1427506M96	88	85	50	710	60	120 x 230			Emaillé Enamelled
2620, 2625, 2640, 2645	19	30/165-148	3041515M94	73	76	405	545	70	150 x 225			Peint Painted
3065	20	30/165-121	3582118M1							47	89	Peint Painted
3015, 3060, 3080, 6110, 6120	21	30/165-122	3388434M1							59	80	Peint Painted
3080, 3085, 3095, 6160, 6170	22	30/165-123	3388432M2							66	89	Peint Painted

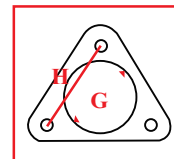
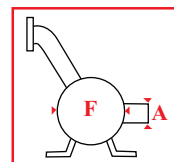
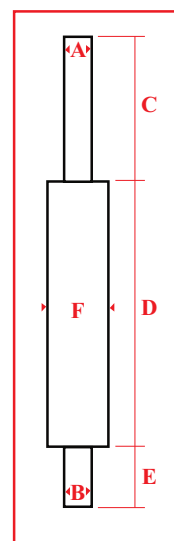

Les références des pièces sont indicatives.
Nos pièces ne sont pas d'origine

Part numbers are quoted for reference purposes only.
Our parts and accessories are not original.



TUYAUX D'EXTENSION POUR ECHAPPEMENTS
EXTENSION PIPES FOR SILENCERS



Tracteurs Tractors	Réf. Ref.	OEM
365, 375, 390	30/166-16 Lg 1000mm	1696602M3
	30/166-18 Lg 1100mm	3598406M6
390, 390T, 396, 398, 399	30/166-17	1696603M3
3050, 3060, 3065, 3070, 3075, 3080, 3085, 3090, 3095, 3115, 3120, 4215, 4220, 4225, 4235, 4240, 4245, 4255, 4260, 4265, 4270, 4315, 4320, 4325, 4335, 4345, 4355, 4360, 4365, 4370, 6110, 6120, 6130, 6140, 6150, 6160, 6170, 6180, 6235, 6245, 6255, 6260	30/166-15	3383014M7
4225, 4235, 4240, 4245, 4255, 4260, 4265, 4270, 4325, 4335, 4365	30/166-14	3819457M1
6160, 6170, 6180, 6190, 8110, 8120, 8130, 8140, 8150, 8160, 8170, 8180	30/166-13	3714356M4

RAINCAPS
WEATHER CAPS



Réf. Ref.	OEM	Ø max. tuyau Pipe max Ø
70/2930-35		35mm-1 ³ / ₈ "
70/2930-38		38mm-1 ¹ / ₂ "
70/2930-45		45mm-1 ³ / ₄ "
70/2930-51	190915M91	51mm-2"
70/2930-57	001686U91	57mm-2 ¹ / ₄ "
70/2930-64		64mm-2 ¹ / ₂ "
70/2930-70		70mm-2 ³ / ₄ "
70/2930-76	1092639V1, 273738M91	76mm-3"
70/2930-89	1498008V1	89mm-3 ¹ / ₂ "
70/2930-95		95mm-3 ³ / ₄ "
70/2930-102	1022537M91	102mm-4"
70/2930-108		108mm-4 ¹ / ₄ "
70/2930-114		114mm-4 ¹ / ₂ "
70/2930-127		127mm-5"
70/2930-152		152mm-6"

COLLIERS
EXHAUST CLAMPS



Réf. Ref.	OEM	Ø max. tuyau Pipe max Ø
70/2935-45		45mm-1 ³ / ₄ "
70/2935-48		48mm-1 ⁷ / ₈ "
70/2935-51		51mm-2"
70/2935-54	1674071M92	54mm-2 ¹ / ₈ "
70/2935-58	1676470M91, 3599710M91	58mm-2 ¹ / ₄ "
70/2935-70	1696972M91, 2700058M91, 3384824M1	70mm-2 ³ / ₄ "
70/2935-79		79mm-3 ¹ / ₈ "
70/2935-92		92mm-3 ⁵ / ₈ "

Les références des pièces sont indicatives.
Nos pièces ne sont pas d'origine

Part numbers are quoted for reference purposes only.
Our parts and accessories are not original.



**FILTRATION
FILTERS**



1

3



2



4

- ⊙ CAV 7111/296
- ↔ Repl. CAV 296
- ⊙ CAV 796
- ↕ Repl. CAV 796
- ↻ A visser / Spin on
- ▣ Cartouche/ Cartridge

- H Direction assistée
Power steering
- ↻ Circuit auxiliaire
Auxiliary circuit
- ❄ Refroidiss. d'huile
Oil cooler
- ↻ Pompes hyd. interne
Internal hydr. pump
- ↻ Circuit ext.
External circuit

Tracteurs Tractors	Moteur Engine	Air		Huile Oil	Combustible Fuel	Hydraulique / Hydraulic	
		Ext. / Out.	Int. / Inn.			Relev. / Lift	
Tracteurs français, anglais & américains / French, UK & USA tractors							
TEA20, 35 (Essence / Petrol)	85mm Petrol 87mm Petrol			60/96-3 (26560090, 1896000M91)			
TEF20, FE35 FE35, 835 (Diesel / Diesel)	20C 23C			60/96-1 (26540218, 894976M91)	60/111-1 (32327, 1850450M2) + 60/111-2 (31944, 1884736M91)		
25, 122 25, 825	A4.99 A4.107				60/111-2 (31944, 1884736M91)		
30, 130	A4.107				60/111-5 ⊙ (26560017, 836218M91) = 60/111-3 ↔ (26561117, 3405418M1)		
35, 140	A3.144 A3.152			60/96-2 (26540132, 1883258M91)	60/111-1 (32327, 1850450M2) ou/or 60/111-5 ⊙ (26560017, 836218M91) = 60/111-3 ↔ (26561117, 3405418M1)	60/625-1 (521451M1)	
65	A4.192				60/111-1 (32327, 1850450M2) + 60/111-2 (31944, 1884736M91)		
65, 765	AD4.203				60/111-1 (32327, 1850450M2) + 60/111-5 ⊙ (26560017, 836218M91) = 60/111-3 ↔ (26561117, 3405418M1)	60/625-1 (521451M1)	60/574-3 H (1883318M1) Ht. 62mm Ø 85mm

Les références des pièces sont indicatives.
Nos pièces ne sont pas d'origine

Part numbers are quoted for reference purposes only.
Our parts and accessories are not original.



"THE RELIABLE SERVICE"



FILTRATION FILTERS

⊙ CAV7111/296 ⇔ Repl.CAV296 ⊙ CAV796 ⚡ Repl.CAV796 ⤴ A visser/Spin on □ Cartouche/Cartridge H Dir assist./Power steering
 ⚡ Circuit auxiliaire/Auxiliary circuit * Refroidiss. d'huile/Oil cooler ⚡ Pompes hyd. interne/Internal hydr. pump ⚡ Circuit ext./External circuit

		1		2	3	4	
Tracteurs Tractors	Moteur Engine	Air		Huile Oil	Combustible Fuel	Hydraulique / Hydraulic	
		Ext. / Out.	Int. / Inn.			Relev. / Lift	
Tracteurs français, anglais & américains / French, UK & USA tractors							
133, 135, 140 (Etroit / Narrow)	A3.144	60/161-100 (1805045M2) <i>Lautrette</i>		60/96-2 □ (26540132, 1883258M91) 60/97-1 ⤴ (2654408, 1447082M91)		60/655-3 (1810539M91) 60/625-2 (1687042M91)	
133, 135MKIII, 135V	AD3.152	60/161-63 (1807255M1) <i>Ailettes / Fins</i>		60/97-1 ⤴ (2654408, 1447082M91)		60/625-2 (1687042M91)	
135	AD3.152	60/161-1 (26510232, 1886637M91) Ht. 235mm ou / or 60/161-100 (1805045M2) Ht. 275mm	60/162-1 (26510233, 1886638M91)	60/96-3 □ (26560090, 1896000M91) 60/97-1 ⤴ (2654408, 1447082M91)		60/655-3 (1810539M91)	60/655-1 * (191855M4)
135, 140, 145 export	AD3.152	60/161-100 (1805045M2) <i>Lautrette</i> 60/161-63 (1807255M1) <i>Ailettes / Fins</i>		60/96-2 □ (26540132, 1883258M91) 60/97-1 ⤴ (2654408, 1447082M91)	60/111-5 ⊙ (26560017, 836218M91) = 60/111-3 ⇔ (26561117, 3405418M1)	60/655-2 * (1862918M91) Ht 79 mm ou / or 60/655-1 * (191855M4) Relevage / lift 60/625-2 (1687042M91) Ø 60 mm Ht: 96 mm ou / or 60/625-1 (521451M1) Ø 63 mm Ht: 99 mm	60/574-1 H (1886135M1) Ht. 40mm Ø 50mm
135, 138, 145V/S, 145MKIII, 148MKIII	AD3.152	60/161-100 (1805045M2) <i>Lautrette</i>		60/96-3 □ (26560090, 1896000M91) 60/97-1 ⤴ (2654408, 1447082M91)		60/625-2 (1687042M91) Ø 60 mm Ht: 96 mm	60/574-1 H (1886135M1) Ht. 40mm Ø 50mm
148	AD3.152	60/161-1 (26510232, 1886637M91) Ht. 235mm ou / or 60/161-100 (1805045M2) Ht. 275mm	60/162-1 (26510233, 1886638M91)	60/96-2 □ (26540132, 1883258M91)		60/625-2 (1687042M91) Ø 60 mm Ht: 96 mm 60/655-3 * (1810539M91)	
152, 152F/V/S, 152MKIII	AD3.152	60/161-100 (1805045M2)		60/97-1 ⤴ (2654408, 1447082M91)		60/625-2 (1687042M91) Ø 60 mm Ht: 96 mm 60/655-3 * (1810539M91) 60/655-4 (1810694M92) Aspir. / Aspir.	

Les références des pièces sont indicatives.
Nos pièces ne sont pas d'origine

Part numbers are quoted for reference purposes only.
Our parts and accessories are not original.



"THE RELIABLE SERVICE"



MF-174

Ed.1 (07/04)

FILTRATION FILTERS

⊕ CAV7111/296 ⊕ Repl.CAV296 ⊕ CAV796 ⊕ Repl.CAV796 ⤴ A visser/Spin on □ Cartouche/Cartridge H Dir assist./Power steering
 Ⓜ Circuit auxiliaire/Auxiliary circuit * Refroidiss. d'huile/Oil cooler ⚡ Pompes hyd. interne/ Internal hydr. pump ⤵ Circuit ext./ External circuit

		1		2	3	4	
Tracteurs Tractors	Moteur Engine	Air		Huile Oil	Combustible Fuel	Hydraulique / Hydraulic	
		Ext. / Out.	Int. / Im.			Relev. / Lift	
Tracteurs français, anglais & américains / French, UK & USA tractors							
155, 158, 158MKIII, 158 F/S/V	AD4.203			60/96-2 □ (26540132, 1883258M91) 60/97-1 ⤴ (2654408, 1447082M91) ou / or 60/97-43 ⤴ (3638606M1) 13/16"		60/625-2 (1687042M91) Ø 60 mm Ht: 96 mm 60/655-3 * (1810539M91) 60/655-4 (1810694M92) Aspir. / Aspir.	
165 165, 165MKII, 865 168, 175, 175S 178, 185, 188	A4.212 AD4.203 A4.236 A4.248			60/96-3 □ (26560090, 1896000M91) 60/97-2 ⤴ (2654403, 1447048M1)	60/111-5 ⊕ (26560017, 836218M91) = 60/111-3 ⊕ (26561117, 3405418M1)	60/655-2 * (1862918M91) Ht 79 mm ou / or 60/655-1 * (191855M4) Ht. 115 mm ou / or 60/655-3 * (1810539M91) Ht. 155mm 60/625-2 (1687042M91)	60/574-21 H (1645894M91) Ht. 56 - Ø84 ou / or 60/574-3 H (1883318M1) Ht.62 - Ø85 ou / or 60/574-4 H (1662566M1) Ht. 74 - Ø71
230	AD3.152	60/161-12 (1688092M2)	60/162-12 (3824033M1)		60/97-1 ⤴ (2654408, 1447082M91)	60/625-14 (3771122M92)	60/574-2 H (1052097M1)
235, 245, 255	AD3.152	60/161-98 (1698675M2)	60/162-98 (1698676M1)			60/625-2 (1687042M91)	60/574-1 H (1886135M1)
240	AD3.152					60/625-14 (3771122M92) ou / or 60/625-2 (1687042M91) 60/655-4 (1810694M92)	60/574-1 H (1886135M1) Ht. 40 - Ø50 ou / or 60/574-2 H (1052097M1) Ht.38 - Ø52
250	AD3.152	60/161-12 (1688092M2)	60/162-12 (3824033M1)	(F) 60/97-2 ⤴ (2654403, 1447048M1) (UK) 60/97-1 ⤴ (2654408, 1447082M91)		60/655-3 (1810539M91) Ht. 155mm ou / or 60/655-4 (1810694M92) Ht. 160mm 60/625-2 (1687042M91)	

Les références des pièces sont indicatives.
Nos pièces ne sont pas d'origine

Part numbers are quoted for reference purposes only.
Our parts and accessories are not original.



FILTRATION FILTERS

⊙ CAV7111/296 ⇔ Repl.CAV296 ⊗ CAV796 ⚡ Repl.CAV796 ⤴ A visser/Spin on □ Cartouche/Cartridge H Dir assist./Power steering
 ⚡ Circuit auxiliaire/Auxiliary circuit * Refroidiss. d'huile/Oil cooler ⤴ Pompes hyd. interne/Internal hydr. pump ⤴ Circuit ext./External circuit

		1		2	3	4		
Tracteurs Tractors	Moteur Engine	Air		Huile Oil	Combustible Fuel	Hydraulique / Hydraulic		
		Ext. / Out.	Int. / Inn.			Relev. / Lift		
Tracteurs français, anglais & américains / French, UK & USA tractors								
253 263	AT3.152.4 903.27T	60/161-22 (3595518M1)	60/162-22 (3595519M1)	60/97-1 ⤴ (2654408, 1447082M91)	60/111-5 ⊙ (26560017, 836218M91) = 60/111-3 ⇔ (26561117, 3405418M1)	60/625-14 (3771122M92) 60/655-4 ⤴ (1810694M92)	60/574-1 H (1886135M1)	
260	AD4.203	60/161-99 (1698683M1)	60/162-99 (1698684M1)		60/111-3 ⇔ (26561117, 3405418M1)	60/655-4 ⤴ (1810694M92) Aspir./ Aspir.		
265 (F) 265 (UK) (⇒193552) 275 (⇒221522)	A4.236	60/161-13 (1678294M1)	60/162-13 (1678295M1)	60/97-2 ⤴ (2654403, 1447048M1)	60/111-5 ⊙ (26560017, 836218M91) = 60/111-3 ⇔ (26561117, 3405418M1) ou / or 60/111-6 ⊙ (26560602, 1896287M91) = 60/111-4 ⚡ (26566602, 3405419M1)	60/655-3 * (1810539M91) 60/655-4 (1810694M92) Aspir./ Aspir. 60/625-2 (1687042M91) ou / or 60/625-14 (3771122M92)	60/574-4 H (1662566M1)	
265 (UK) (193553 ⇔) 275 (221523 ⇔) 275E 265S, 285S 275E	A4.236 A4.41	60/161-78 (3824035M1)	60/162-78 (3824036M1)					
290 (F) 290 (UK) (⇒387020) 290E	A4.248 A4.41	60/161-13 (1678294M1)	60/162-13 (1678295M1)			60/111-6 ⊙ (26560602, 1896287M91) = 60/111-4 ⚡ (26566602, 3405419M1)	60/655-3 (1810539M91) 60/655-4 (1810694M92) Aspir./ Aspir. 60/625-14 (3771122M92)	
290 (UK) (387021⇔) 290E	A4.248	60/161-78 (3824035M1)	60/162-78 (3824036M1)					
298	A4.318.2	60/161-14 (1698374M2)	60/162-14 (1698375M2)		60/111-5 ⊙ (26560017, 836218M91) = 60/111-3 ⇔ (26561117, 3405418M1)	60/625-2 (1687042M91) 60/240-25 (3307250M91) 60/655-4 (1810694M92)		
340, 342, 350	AD3.352	60/161-22 (3595518M1)	60/162-22 (3595519M1)	60/97-1 ⤴ (2654408, 1447082M91)	60/111-3 ⇔ (26561117, 3405418M1)	60/625-2 ⤴ (1687042M91) ou / or 60/625-14 ⤴ (3771122M92) 60/625-4 ⤴ (3800305M91)	60/574-1 H (1886135M1)	
352, 355, 360	AT3.152					60/625-14 ⤴ (3771122M92) 60/625-4 ⤴ (3800305M91)	60/569-1 H ⤴ (3595175M1)	
362, 362N, 372, 372N, 382, 382N	A4.236 A4.248	60/161-23 (3595500M1) Dessus capot Over bonnet Ø 177mm 60/161-24 (3595503M1) Sous capot Under bonnet Ø 155mm	60/162-23 (3595501M1)	60/97-2 ⤴ (2654403, 1447048M1)	60/111-6 ⊙ (26560602, 1896287M91) = 60/111-4 ⚡ (26566602, 3405419M1)	60/625-4 ⤴ (3800305M91)	60/569-1 H ⤴ (3595175M1)	
365, 375 390 390T, 398 396, 399 399	A4.236 A4.248 AT4.236 1006.6 A6.354.4					60/625-2 ⤴ (1687042M91) ou / or 60/625-14 ⤴ (3771122M92) 60/625-4 ⤴ (3800305M91)	60/574-1 H (1886135M1) 60/569-1 H ⤴ (3595175M1)	

Les références des pièces sont indicatives.
Nos pièces ne sont pas d'origine

Part numbers are quoted for reference purposes only.
Our parts and accessories are not original.



"THE RELIABLE SERVICE"



MF-176

Ed.1 (07/04)

FILTRATION FILTERS

⊙ CAV7111/296 ⇔ Repl.CAV296 ⊕ CAV796 † Repl.CAV796 ⤴ A visser/Spin on □ Cartouche/Cartridge H Dir assist./Power steering
 Ⓢ Circuit auxiliaire/Auxiliary circuit * Refroidiss. d'huile/Oil cooler ⤵ Pompes hyd. interne/ Internal hydr. pump ⤶ Circuit ext./ External circuit

		1		2	3	4	
Tracteurs Tractors	Moteur Engine	Air		Huile Oil	Combustible Fuel	Hydraulique / Hydraulic	
		Ext. / Out.	Int. / Im.			Relev. / Lift	
Tracteurs français, anglais & américains / French, UK & USA tractors							
375E 390E	A4.236 A4.248	60/161-78 (3824035M1)	60/162-78 (3824036M1)	60/97-2 ⤴ (2654403, 1447048M1)		60/625-2 ⤵ (1687042M91)	60/574-1 H (1886135M1)
375E, 390E	A4.41					60/625-4 ⤵ (3800305M91)	60/569-1 H ⤴ (3595175M1)
550	AD3.152	⇒ 619578 60/161-98 (1698675M2) 619579 ⇒ 60/161-12 (1688092M2)	60/162-98 (1698676M1) 60/162-12 (3824033M1)	60/97-1 ⤴ (2654408, 1447082M91)	60/111-6 ⊕ (26560602, 1896287M91) = 60/111-4 † (26566602, 3405419M1)		60/574-1 H (1886135M1) Ht. 40 - Ø50 ou / or 60/574-2 H (1052097M1) Ht.38 - Ø52
560	AD4.203	60/161-99 (1698683M1)	60/162-99 (1698684M1)			60/655-3 * (1810539M91) ou / or 60/655-4 * (1810694M92)	60/574-4 H (1662566M1)
565	A4.236	60/161-13 (1678294M1)	60/162-13 (1678295M1)				
575 590	A4.236 A4.248					60/625-2 ⤵ (1687042M91)	60/574-21 H (1645894M91) Ht. 56 - Ø84 ou / or 60/574-4 H (1662566M1) Ht. 74 - Ø71
592, 595	A4.318	60/161-14 (1698374M2)	60/162-14 (1698375M2)	60/97-2 ⤴ (2654403, 1447048M1)	60/111-5 ⊕ (26560017, 836218M91) = 60/111-3 ⇔ (26561117, 3405418M1)		
675 690	A4.236 A4.248	60/161-13 (1678294M1)	60/162-13 (1678295M1)		60/111-6 ⊕ (26560602, 1896287M91) = 60/111-4 † (26566602, 3405419M1)		60/574-4 H (1662566M1)
698	A4.318.2	60/161-14 (1698374M2)	60/162-14 (1698375M2)			60/625-2 ⤵ (1687042M91)	
698T	AT4.236	60/161-25 (1062501M91)	60/162-25 (26510228, 1093683M92)	60/97-3 ⤴ (2654407, 1447031M1)		60/655-4 * (1810694M92)	
699	A6.354.4						
1004	A4.318.2	60/161-14 (1698374M2)	60/162-14 (1698375M2)	60/97-2 ⤴ (2654403, 1447048M1)		60/655-4 (1810694M92)	60/574-4 H (1662566M1)
1004T	AT4.236	60/161-25 (1062501M91)	60/162-25 (26510228, 1093683M92)				
1080	A4.318	60/161-95 (1035408M92) Sans colerette Less flange		60/96-3 □ (26560090, 1896000M91) ou / or 60/97-2 ⤴ (2654403, 1447048M1)	60/111-5 ⊕ (26560017, 836218M91) = 60/111-3 ⇔ (26561117, 3405418M1)	60/240-7 ⤵ 60/655-1 * (191855M4) (⇒ M273000) 60/655-3 * (1810539M91) (M273001 ⇒)	60/574-21 H (1645894M91)
1200 1250	A6.354.1 A6.354.4	60/161-60 (3638563M1)	60/162-25 (26510228, 1093683M92)	60/97-3 ⤴ (2654407, 1447031M1)		60/625-2 ⤵ (1687042M91) 60/574-14 * (1039161M91)	60/655-3 (1810539M91)
2620, 2640 (271213 ⇒) 2680	A6.354.4 A6.354.4 AT6.354.4	60/161-25 (1062501M91)	60/162-25 (26510228, 1093683M92)			60/240-28 □ (1636924M3) ou / or 60/240-61 ⤴ (3383386M92)	
2640 (⇒ 271212)	A6.354.4	60/161-97 (1633459M1)	60/162-97 (1633458M1)				

Les références des pièces sont indicatives.
Nos pièces ne sont pas d'origine

Part numbers are quoted for reference purposes only.
Our parts and accessories are not original.



FILTRATION FILTERS

⊙ CAV7111/296 ⇔ Repl.CAV296 ⊙ CAV796 ⇕ Repl.CAV796 ⤴ A visser/Spin on □ Cartouche/Cartridge H Dir assist./Power steering
 ⚡ Circuit auxiliaire/Auxiliary circuit * Refroidiss. d'huile/Oil cooler ⚙ Pompes hyd. interne/Internal hydr. pump ⚡ Circuit ext./External circuit

		1		2	3	4	
Tracteurs Tractors	Moteur Engine	Air		Huile Oil	Combustible Fuel	Hydraulique / Hydraulic	
		Ext. / Out.	Int. / Inn.			Relev. / Lift	
Tracteurs français, anglais & américains / French, UK & USA tractors							
2625, 2645 2685	A6.354.4 AT6.354.4			60/97-3 ⤴ (2654407, 1447031M1)	60/111-6 ⊙ (26560602, 1896287M91) = 60/111-4 ⇕ (26566602, 3405419M1)	60/240-28 □ (1636924M3) ou / or 60/240-61 ⤴ (3383386M92)	
2720	AT6.354.4	60/161-26 (1644333M1)	60/162-26 (1644334M1)		60/111-5 ⊙ (26560017, 836218M91) = 60/111-3 ⇔ (26561117, 3405418M1)		
2725	AT6.354.4			60/97-2 ⤴ (2654403, 1447048M1)		60/240-61 ⤴ (3383386M92)	
3050 3060 3065	A4.236 A4.248 AT4.236	60/161-25 (1062501M91) 60/161-104 (3310355M91) <i>Capot plongeant Steep nose</i>	60/162-25 (26510228, 1093683M92)		60/111-6 ⊙ (26560602, 1896287M91) = 60/111-4 ⇕ (26566602, 3405419M1)		60/240-41 H (3619594M1) 6" ou / or 60/574-7 H (3615949M2) 8"
3070	AT4.236						
3080, 3090	A6.354			60/97-3 ⤴ (2654407, 1447031M1)	60/111-5 ⊙ (26560017, 836218M91) = 60/111-3 ⇔ (26561117, 3405418M1)		
3075	1004.4T			60/97-2 ⤴ (2654403, 1447048M1)	60/111-63 (3638291M1) = 60/111-25 <i>Repl. CAV 496</i>	60/625-6 (3616579M2) Ht 98mm 60/625-5 (3581032M2) Ht 165mm	
3085, 3095, 3115 3120	1006.6 1006.6T			60/97-3 ⤴ (2654407, 1447031M1)			
3125	1006.6T			60/97-2 ⤴ (2654403, 1447048M1) ou / or 60/97-3 ⤴ (2654407, 1447031M1)	⇔ 514769 60/111-5 ⊙ (26560017, 836218M91) = 60/111-3 ⇔ (26561117, 3405418M1) 514770 ⇔ 60/111-63 (3638291M1) = 60/111-25 <i>Repl. CAV 496</i>	60/240-41 H (3619594M1) 6" ou / or 60/574-7 H (3615949M2) 8"	
3610	A6.354.4			60/97-3 ⤴ (2654407, 1447031M1)	60/111-5 ⊙ (26560017, 836218M91) = 60/111-3 ⇔ (26561117, 3405418M1)	60/625-7 (3386701M2)	

Les références des pièces sont indicatives.
Nos pièces ne sont pas d'origine

Part numbers are quoted for reference purposes only.
Our parts and accessories are not original.



"THE RELIABLE SERVICE"



MF-178

Ed.1 (07/04)

FILTRATION FILTERS

⊙ CAV7111/296 ⇄ Repl.CAV296 ⊗ CAV796 † Repl.CAV796 ⤴ A visser/Spin on □ Cartouche/Cartridge H Dir assist./Power steering
 ⤵ Circuit auxiliaire/Auxiliary circuit * Refroidiss. d'huile/Oil cooler ⤴ Pompes hyd. interne/ Internal hydr. pump ⤵ Circuit ext./ External circuit

		1		2	3	4			
Tracteurs Tractors	Moteur Engine	Air		Huile Oil	Combustible Fuel	Hydraulique / Hydraulic			
		Ext. / Out.	Int. / Im.			Relev. / Lift			
Tracteurs français, anglais & américains / French, UK & USA tractors									
3630	AT6.354.4			60/97-2 ⤴ (2654403, 1447048M1)	60/111-6 ⊙ (26560602, 1896287M91) = 60/111-4 † (26566602, 3405419M1)	60/625-7 (3386701M2)			
3635	1006.6T	60/161-27 (3385733M1)	60/162-27 (3385734M1)	60/97-2 ⤴ (2654403, 1447048M1) ou / or 60/97-3 ⤴ (2654407, 1447031M1)	60/111-63 (3638291M1)	60/625-7 (3386701M2) Droit / RH	Load sensing 60/240-40 (3618662M1)		
3645	1006.6T						60/625-9 (3619712M1) Gauche / LH		
3650	AT6.354.4					60/97-2 ⤴ (2654403, 1447048M1)	60/111-6 ⊙ (26560602, 1896287M91) = 60/111-4 † (26566602, 3405419M1)	60/625-7 (3386701M2)	
3655	1006.6T				60/111-63 (3638291M1)	60/625-7 (3386701M2) Droit / RH	Load sensing 60/240-40 (3618662M1)		
3670	620DS	60/161-77 (3580723M1)	60/162-77 (3580724M1)	60/97-33 (V836662111)	60/111-6 ⊙ (26560602, 1896287M91) = 60/111-4 † (26566602, 3405419M1)	60/625-9 (3619712M1) Gauche / LH	Load sensing 60/240-40 (3618662M1)		
3680	612DS						60/97-34 (3637652M1)	60/625-7 (3386701M2)	
3690	612DS						60/97-33 (V836662111) Ht 146mm ou / or 60/97-34 (3637652M1) Ht. 270mm	60/625-7 (3386701M2) Droit / RH	Load sensing 60/240-40 (3618662M1)
4215, 4315 4220, 4320	903.27 903.27T	60/161-118 (3901462M1) Ht 319mm ou / or 60/161-119 (3901464M1) Ht 359mm	60/162-118 (3901463M1) Ht 305mm 60/162-119 (3901465M1) Ht 345mm	60/97-2 ⤴ (2654403, 1447048M1)					
4225, 4235, 4240 4225 4235	A4.41 1004.40 1004.40T	60/161-119 (3901464M1) Ht 359mm ou / or 60/161-120 (3901475M1) Ht 347mm	60/162-119 (3901465M1) Ht 345mm 60/162-120 (3901476M1) Ht 360mm	60/97-2 ⤴ (2654403, 1447048M1) ou / or 60/97-3 ⤴ (2654407, 1447031M1)	60/111-5 ⊙ (26560017, 836218M91) = 60/111-3 ⇄ (26561117, 3405418M1)	60/625-4 ⤴ (3800305M91)	60/569-1 (3595175M1) Sans pompe aux Less aux. pump		
4245, 4255 4265, 4365 4245, 4255, 4345, 4355 4325 4335	1004.4T 1004.4TW 1004.40T 1004.40 1004.42					60/97-3 ⤴ (2654407, 1447031M1)		60/625-14 (3771122M92)	

Les références des pièces sont indicatives.
Nos pièces ne sont pas d'origine

Part numbers are quoted for reference purposes only.
Our parts and accessories are not original.



"THE RELIABLE SERVICE"



FILTRATION FILTERS

⊙ CAV7111/296 ⇔ Repl.CAV296 ⊗ CAV796 † Repl.CAV796 ⤴ A visser/Spin on □ Cartouche/Cartridge H Dir assist./Power steering
 ⚡ Circuit auxiliaire/Auxiliary circuit * Refroidiss. d'huile/Oil cooler ⚙ Pompes hyd. interne/Internal hydr. pump ⚡ Circuit ext./External circuit

		1		2	3	4		
Tracteurs Tractors	Moteur Engine	Air		Huile Oil	Combustible Fuel	Hydraulique / Hydraulic		
		Ext. / Out.	Int. / Inn.			Relev. / Lift		
Tracteurs français, anglais & américains / French, UK & USA tractors								
4260, 4270	1006.6	60/161-120 (3901475M1) Ht 347mm	60/162-120 (3901476M1) Ht 360mm	60/97-3 ⤴ (2654407, 1447031M1)	60/111-5 ⊙ (26560017, 836218M91) = 60/111-3 ⇔ (26561117, 3405418M1)	60/625-4 ⤴ (3800305M1)	60/569-1 (3595175M1) Sans pompe aux Less aux. pump	
4260, 4360	1006.60	ou / or						
4270, 4370	1006.60T	60/161-121 (3901477M1) Ht 398mm	60/162-121 (3901478M1) Ht 385mm					
6110, 6120	A4.41	60/161-25 (1062501M91)	60/162-25 (26510228, 1093683M92)	60/97-2 ⤴ (2654403, 1447048M1)	60/111-63 (3638291M1) = 60/111-25 <i>Repl. CAV 496</i>	60/625-6 ⤴ (3616579M2)	60/240-41 H (3619594M1) 6" ou / or 60/574-7 H (3615949M2) 8" Load sensing 60/240-40 (3618662M1) Droit / RH 60/240-85 (3714453M1) Gauche / LH	
6130, 6140	1004.4T	60/161-104 (3310355M91) Capot plongeant Steep nose						
6150 6160, 6170 6170, 6180 6180	1004.4T 1006.6 1006.60T 1006.6T	60/161-25 (1062501M91)						
6190	1006.6T	60/161-27 (3385733M1)						60/162-27 (3385734M1)
6235, 6245	1004.40T	60/161-119 (3901464M1) Ht 359mm						60/162-119 (3901465M1) Ht 345mm
6255	1004.40T	60/161-119 (3901464M1) Ht 359mm Capot plongeant Steep nose ou / or 60/161-120 (3901475M1) Ht 347mm	60/162-119 (3901465M1) Ht 345mm 60/162-120 (3901476M1) Ht 360mm	60/97-3 ⤴ (2654407, 1447031M1)	60/111-5 ⊙ (26560017, 836218M91) = 60/111-3 ⇔ (26561117, 3405418M1) Décanteur Strainer 60/111-202 (3780299M1) 150µ	60/625-7 (3386701M2) Droit / RH 60/625-9 ⤴ (3619712M1) Gauche / LH	Load sensing 60/240-40 (3618662M1) Droit / RH 60/240-85 (3714453M1) Gauche / LH Embrayage Clutch 60/641-27 (3792287M1)	
6260 6265	1006.60 1004.40TW	60/161-120 (3901475M1)	60/162-120 (3901476M1)					
6270, 6280, 6290	1006.60T	60/161-121 (3901477M1)	60/162-121 (3901478M1)					
8110, 8120 8120	1006.6T 1006.60T	60/161-27 (3385733M1)	60/162-27 (3385734M1)	60/97-2 ⤴ (2654403, 1447048M1)	60/111-63 (3638291M1) = 60/111-25 <i>Repl. CAV 496</i>	60/625-7 (3386701M2) Droit / RH 60/625-9 ⤴ (3619712M1) Gauche / LH	Load sensing 60/240-40 (3618662M1)	
8130	1006.6T							
8140, 8150 8160	620DS 634DS	60/161-77 (3580723M1)	60/162-77 (3580724M1)	60/97-33 (V836662111)	60/111-6 ⊙ (26560602, 1896287M91) = 60/111-4 † (26566602, 3405419M1)	Droit / RH 60/240-40 (3618662M1) Gauche / LH 60/240-85 (3714453M1) Ht. 98 - 45cc ou / or 60/240-39 (3790002M1) Ht. 139 - 60cc	Full Power 60/240-40 (3618662M1)	
8170, 8180	645DSBIE	60/161-125 (3903030M1)	60/162-125 (3903031M1)	60/97-61 (V836859108)				

Les références des pièces sont indicatives.
Nos pièces ne sont pas d'origine

Part numbers are quoted for reference purposes only.
Our parts and accessories are not original.



"THE RELIABLE SERVICE"



FILTRATION FILTERS

⊙ CAV7111/296 ⇔ Repl.CAV296 ⊗ CAV796 † Repl.CAV796 ⤴ A visser/Spin on □ Cartouche/Cartridge † Dir assist./Power steering
 Ⓞ Circuit auxiliaire/Auxiliary circuit * Refroidiss. d'huile/Oil cooler ⤴ Pompes hyd. interne/ Internal hydr. pump ⤴ Circuit ext./ External circuit

Tracteurs Tractors	Moteur Engine	1		2	3	4	
		Air		Huile Oil	Combustible Fuel	Hydraulique / Hydraulic	
		Ext. / Out.	Int. / Im.			Relev. / Lift	
Tracteurs français, anglais & américains / French, UK & USA tractors							
8210, 8220	1006.60T				60/111-5 ⊙ (26560017, 836218M91) = 60/111-3 ⇔ (26561117, 3405418M1) Décanteur Strainer 60/111-202 (3780299M1) 150µ		Full Power 60/240-40 (3618662M1) Embrayage Clutch 60/641-27 (3792287M1)
8240 8250, 8260	620DSRAE 634DSBAE	60/161-124 (3782386M1)	60/162-124 (3782387M1)	60/97-33 (V836662111)	60/111-6 ⊗ (26560602, 1896287M91) = 60/111-4 † (26566602, 3405419M1)	Droit / RH 60/240-40 (3618662M1) Gauche / LH 60/240-85 (3714453M1) Ht. 98 - 45cc ou / or 60/240-39 (3790002M1) Ht. 139 - 60cc	Full Power 60/240-40 (3618662M1)
8240Xtra 8250Xtra	620DWBAE 634DWBAE	60/161-165 (3902783M1)	60/162-165 (3902782M1)				
8260 LST	634DSBIE	60/161-127 (5016603M1)	60/162-127 (5016604M1)				
8260Xtra	634DWBAE	60/161-126 (4270017M1)	60/162-126 (4270018M1)	60/97-61 (V836859108)	Décanteur Strainer 60/111-202 (3780299M1) 150µ		Full Power 60/240-40 (3618662M1)
8270, 8280	645DSBIE	60/161-127 (5016603M1)	60/162-127 (5016604M1)				
8270Xtra, 8280Xtra	645DSBAE	60/161-126 (4270017M1)	60/162-126 (4270018M1)				

Les références des pièces sont indicatives.
Nos pièces ne sont pas d'origine

Part numbers are quoted for reference purposes only.
Our parts and accessories are not original.



FILTRATION FILTERS

⊙ CAV7111/296 ⇔ Repl.CAV296 ⊙ CAV796 ⚙ Repl.CAV796 ⤴ A visser/Spin on □ Cartouche/Cartridge H Dir assist./Power steering
 ⚡ Circuit auxiliaire/Auxiliary circuit * Refroidiss. d'huile/Oil cooler ⚙ Pompes hyd. interne/Internal hydr. pump ⚡ Circuit ext./External circuit

Tracteurs Tractors	Moteur Engine	1		2	3	4		
		Air		Huile Oil	Combustible Fuel	Hydraulique / Hydraulic		
		Ext. / Out.	Int. / Im.			Relev. / Lift		
IT Tracteurs italiens / Italian tractors								
134V, 154S, 154V	AD3.152	60/161-142 (3310358M1)	60/162-142 (3595519M1)	60/96-2 □ (26540132, 1883258M91)		60/240-25 (3307250M91)	60/574-25 H (3300901M91)	
154								
154F		60/161-142 (3310358M1)	60/162-142 (3595519M1)			60/97-1 ⤴ (2654408, 1447082M91)	60/240-25 (3307250M91)	60/641-26 ⤴ (3530223M92)
164TF, 164TS, 164TV	AT3.152.4					60/240-25 (3307250M91)		
174, 184	A4.236			60/96-3 □ (26560090, 1896000M91)		60/240-25 (3307250M91)		
174F, 184F		60/161-142 (3310358M1)	60/162-142 (3595519M1)			60/97-2 ⤴ (2654403, 1447048M1)	60/641-26 ⤴ (3530223M92)	60/574-25 H (3300901M91)
174S, 174V, 184S							60/240-25 (3307250M91)	
194	A4.248			60/97-2 ⤴ (2654403, 1447048M1)		60/240-25 (3307250M91)		
194F		60/161-142 (3310358M1)	60/162-142 (3595519M1)			60/111-5 ⊙ (26560017, 836218M91)	60/641-26 ⤴ (3530223M92)	60/574-25 H (3300901M91)
194S								
233	AD3.152			60/97-1 ⤴ (2654408, 1447082M91)		60/240-25 (3307250M91)		
234C/CF, 244CF						60/111-3 ⇔ (26561117, 3405418M1)		
253								
254, 254S	AT3.152.4	60/161-99 (1698683M1)	60/162-99 (1698684M1)					
263T								
264T		60/161-99 (1698683M1)	60/162-99 (1698684M1)		60/240-25 (3307250M91)	60/574-25 H (3300901M91)		
264TS								
273	A4.236			60/97-2 ⤴ (2654403, 1447048M1)		60/240-25 (3307250M91)		
274, 274S		60/161-99 (1698683M1)	60/162-99 (1698684M1)					
274C, 274CF								
274SK	A4.248	60/161-142 (3310358M1)	60/162-142 (3595519M1)			60/240-25 (3307250M91)		
283, 284								
284S						60/574-25 H (3300901M91)		
293, 294	A4.248							
294S		60/161-142 (3310358M1)	60/162-142 (3595519M1)		60/240-25 (3307250M91)			
294C								

Les références des pièces sont indicatives.
Nos pièces ne sont pas d'origine



"THE RELIABLE SERVICE"



Part numbers are quoted for reference purposes only.
Our parts and accessories are not original.

MF-182

Ed.1 (07/04)

FILTRATION FILTERS

⊙ CAV7111/296 ⇔ Repl.CAV296 ⊗ CAV796 † Repl.CAV796 ⤴ A visser/Spin on □ Cartouche/Cartridge H Dir assist./Power steering
 Ⓢ Circuit auxiliaire/Auxiliary circuit * Refroidiss. d'huile/Oil cooler ⚙ Pompes hyd. interne/ Internal hydr. pump ⤵ Circuit ext./ External circuit

Tracteurs Tractors	Moteur Engine	1		2	3	4		
		Air		Huile Oil	Combustible Fuel	Hydraulique / Hydraulic		
		Ext. / Out.	Int. / Inn.			Relev. / Lift		
IT Tracteurs italiens / Italian tractors								
333	AD3.152			60/97-1 ⤴ (2654408, 1447082M91)	60/111-5 ⊙ (26560017, 836218M91)	60/240-25 (3307250M91)	60/574-25 H (3300901M91)	
334V		60/161-142 (3310358M1)	60/162-142 (3595519M1)			60/641-26 (3530223M92)		
353, 353S		60/161-143 (3540046M1)	60/162-143 (3540047M1)			60/240-25 (3307250M91)		
353LX								
354 SP/FP/AP/GE								
354F/V								
354VQ		60/161-142 (3310358M1)	60/162-142 (3595519M1)			60/641-26 (3530223M92)		60/625-11 (3551956M91)
356CF								60/574-25 H (3300901M91)
363								⇨ P06076 60/240-25 (3307250M91)
363S								P06077 ⇨ 60/641-26 (3530223M92)
363LX	AT3.152.4	60/161-143 (3540046M1)	60/162-143 (3540047M1)	60/97-2 ⤴ (2654403, 1447048M1)	60/111-3 ⇔ (26561117, 3405418M1)	60/641-26 (3530223M92)	60/625-11 (3551956M91)	
364SP/FP/AP/GE								
364F/V		60/161-142 (3310358M1)	60/162-142 (3595519M1)					
364VQ								
366CF	A4.236	60/161-143 (3540046M1)	60/162-143 (3540047M1)	60/97-2 ⤴ (2654403, 1447048M1)	60/111-3 ⇔ (26561117, 3405418M1)			
367CF								
373								
373S								
373LX		60/161-143 (3540046M1)	60/162-143 (3540047M1)					
374SP/FP/AP/GE								
374F/V/S		60/161-142 (3310358M1)	60/162-142 (3595519M1)			60/641-26 (3530223M92)	60/625-11 (3551956M91)	
374VQ								
376C, 376CF								
377						60/240-25 ⊙ (3307250M91)	60/574-25 H (3300901M91)	
			60/641-26 (3530223M92)					
383								
383LX	60/161-143 (3540046M1)	60/162-143 (3540047M1)	60/641-26 (3530223M92)	60/574-25 H (3300901M91)				
383S			⇨ P06076 60/240-25 (3307250M91)					
			P06077 ⇨ 60/641-26 (3530223M92)					

Les références des pièces sont indicatives.
Nos pièces ne sont pas d'origine

Part numbers are quoted for reference purposes only.
Our parts and accessories are not original.



FILTRATION FILTERS

⊙ CAV7111/296 ⇔ Repl.CAV296 ⊙ CAV796 † Repl.CAV796 ⤴ A visser/Spin on □ Cartouche/Cartridge H Dir assist./Power steering
 Ⓢ Circuit auxiliaire/Auxiliary circuit * Refroidiss. d'huile/Oil cooler ⤵ Pompes hyd. interne/Internal hydr. pump ⤴ Circuit ext./External circuit

Tracteurs Tractors	Moteur Engine	1		2	3	4			
		Air		Huile Oil	Combustible Fuel	Hydraulique / Hydraulic			
		Ext. / Out.	Int. / Inn.			Relev. / Lift			
IT Tracteurs italiens / Italian tractors									
384SP/FP/AP/GE	A4.236	60/161-143 (3540046M1)	60/162-143 (3540047M1)	60/97-2 ⤴ (2654403, 1447048M1)	60/111-5 ⊙ (26560017, 836218M91)	60/641-26 (3530223M92)	60/574-25 H (3300901M91)		
384F/S/V		60/161-142 (3310358M1)	60/162-142 (3595519M1)				60/625-11 (3551956M91)		
384VQ		60/161-142 (3310358M1)	60/162-142 (3595519M1)				⇒ P04064 60/240-25 (3307250M91)		
387	A4.248	60/161-143 (3540046M1) View master	60/162-143 (3540047M1) View master			P04065 ⇒ 60/641-26 (3530223M92)	60/574-25 H (3300901M91)		
393		60/161-143 (3540046M1)	60/162-143 (3540047M1)			60/641-26 (3530223M92)			
393LX	A4.248					⇒ P06076 60/240-25 (3307250M91)			
393S						P06077 ⇒ 60/641-26 (3530223M92)			
393TLX		AT4.248	60/161-153 (3540051M1)			60/162-153 (3540052M1)			
394SP/FP/AP/GE	A4.248	60/161-143 (3540046M1)	60/162-143 (3540047M1)			60/111-3 ⇔ (26561117, 3405418M1)		60/641-26 (3530223M92)	
394F/S/V		60/161-142 (3310358M1)	60/162-142 (3595519M1)					60/240-25 Ⓢ (3307250M91)	
394C/CF		60/161-143 (3540046M1)	60/162-143 (3540047M1)					60/641-26 (3530223M92)	
394T	AT4.236	60/161-153 (3540051M1)	60/162-153 (3540052M1)					60/641-26 (3530223M92)	60/574-25 H (3300901M91)
396C/CF	A4.248	60/161-143 (3540046M1)	60/162-143 (3540047M1)					60/240-25 Ⓢ (3307250M91)	
396CT	AT4.236	60/161-153 (3540051M1)	60/162-153 (3540052M1)				60/641-26 (3530223M92)		
397	A4.248	60/161-143 (3540046M1)	60/162-143 (3540047M1)				⇒ P04064 60/240-25 (3307250M91)		
397T	AT4.236	60/161-104 (3310355M91)	60/162-25 (26510228, 1093683M92)	⇒ P04065 ⇒ 60/641-26 (3530223M92)					
1007				60/641-26 (3530223M92)					

Les références des pièces sont indicatives.
Nos pièces ne sont pas d'origine



"THE RELIABLE SERVICE"



Part numbers are quoted for reference purposes only.
Our parts and accessories are not original.

MF-184

Ed.1 (07/04)

FILTRATION FILTERS

⊙ CAV7111/296 ⇔ Repl.CAV296 ⊕ CAV796 † Repl.CAV796 ⤴ A visser/Spin on □ Cartouche/Cartridge H Dir assist./Power steering
 Ⓢ Circuit auxiliaire/Auxiliary circuit * Refroidiss. d'huile/Oil cooler ⤵ Pompes hyd. interne/ Internal hydr. pump ⤴ Circuit ext./ External circuit

		1		2	3	4		
Tracteurs Tractors	Moteur Engine	Air		Huile Oil	Combustible Fuel	Hydraulique / Hydraulic		
		Ext. / Out.	Int. / Inn.			Relev. / Lift		
IT Tracteurs italiens / Italian tractors								
1014	A6.354.1	⇒ 12900159 60/161-60 (3638563M1)	60/162-25 (26510228, 1093683M92)	60/97-3 ⤴ (2654407, 1447031M1)	60/111-5 ⊙ (26560017, 836218M91) = 60/111-3 ⇔ (26561117, 3405418M1)	⇒ V8004 60/240-23 (1425418M1)	Bras de relevage <i>Lift arm</i> 60/240-22 (1425411M91)	
1014	A6.354.4	12900160 ⇒ 60/161-104 (3310355M91)				V8005 ⇒ 60/641-26 (3530223M92)	Blocage du diff. <i>Differential lock</i> 60/240-26 (3302055M91)	
1024	A6.354.4	60/161-104 (3310355M91)	60/162-25 (26510228, 1093683M92)				Carter relev. <i>Lift Housing</i> 60/240-27 (974535M2)	
1104	A6.354.1	60/161-141 (3637417M1)					Relev. / Lift 60/641-26 (3530223M92)	
1114	A6.354.4	60/161-60 (3638563M1)	60/162-25 (26510228, 1093683M92)					Bras de relevage <i>Lift arm</i> 60/240-22 (1425411M91)
1134	AT6.354.4	60/161-105 (1426451M91)	60/162-64 (1426450M91)				⇒ 2422N 60/240-23 (1425418M1) 2423N ⇒ 60/641-26 (3530223M92)	Blocage du diff. <i>Differential lock</i> 60/240-26 (3302055M91) Ht. 130mm ou /or 60/240-24 (1426462M91) Ht. 80mm
2205	AD3.152					60/97-1 ⤴ (2654408, 1447082M91)		
2210 2220	903.27 903.27T							
2230	1004.42	60/161-143 (3540046M1)	60/162-143 (3540047M1)			60/97-2 ⤴ (2654403, 1447048M1)	60/111-63 (3638291M1) = 60/111-25 Repl. CAV 496	
3210SP/FP/GE	AD3.152					60/97-1 ⤴ (2654408, 1447082M91)	60/111-5 ⊙ (26560017, 836218M91)	60/641-26 (3530223M92)
3220SP/FP/AP/GE, 3225SP/FP/AP/GE	A4.236							
3315 3325 3330 3340 3350, 3355	903.27 903.27T 1004.40 1004.42 1004.40T	60/161-104 (0.010.3169.0)	60/162-25 (2.4249.130.7)	60/97-2 ⤴ (2654403, 1447048M1)	60/111-3 ⇔ (26561117, 3405418M1)		60/240-41 H (3619594M1)	

Les références des pièces sont indicatives.
Nos pièces ne sont pas d'origine

Part numbers are quoted for reference purposes only.
Our parts and accessories are not original.



"THE RELIABLE SERVICE"



FILTRATION FILTERS

⊕ CAV7111/296 ⇔ Repl.CAV296 ⊗ CAV796 ⚡ Repl.CAV796 ⤴ A visser/Spin on □ Cartouche/Cartridge H Dir assist./Power steering
 ⚡ Circuit auxiliaire/Auxiliary circuit * Refroidiss. d'huile/Oil cooler ⤴ Pompes hyd. interne/ Internal hyd: pump ⤴ Circuit ext./ External circuit

		1		2	3	4	
 Tracteurs Tractors	Moteur Engine	Air		Huile Oil	Combustible Fuel	Hydraulique / Hydraulic	
		Ext. / Out.	Int. / Im.			Relev. / Lift	
Chargeurs télescopiques / Telescopic handlers							
8925, 8926, 8937, 8939 8925, 8926, 8937, 8939	1004.4 1004.42	60/161-118 (3901462M1) Ht 319mm	60/162-118 (3901463M1) Ht 305mm	60/97-2 ⤴ (2654403, 1447048M1)	60/111-63 (3638291M1)		
8925T, 8926T, 8937T, 8939T 8925T, 8926T, 8937T, 8939T	1004.4T 1004.40T	60/161-119 (3901464M1) Ht 359mm	60/162-119 (3901465M1) Ht 345mm	60/97-3 ⤴ (2654407, 1447031M1)	60/111-25 Repl. CAV 496		
Moissonneuses-batteuses / Combines							
24, 27, 29, 29XP, 31, 31XP	AT6.354.4			60/97-3 ⤴ (2654407, 1447031M1)			
31	AT6.354.4			60/96-15 (26540154, 1883287M91)	60/111-5 ⊕ (26560017, 836218M91)		
186, 187, 206	A4.212 A4.236			60/96-3 (26560090, 1896000M91) ou /or 60/97-1 ⤴ (2654408, 1447082M91)	60/111-3 ⇔ (26561117, 3405418M1)		
240 430, 440	A4.236 A4.248			60/97-2 ⤴ (2654403, 1447048M1) ou /or 60/97-3 ⤴ (2654407, 1447031M1)	60/111-5 ⊕ (26560017, 836218M91) = 60/111-3 ⇔ (26561117, 3405418M1) ou /or 60/111-6 ⊕ (26560602, 1896287M91) = 60/111-4 ⚡ (26566602, 3405419M1)		
307, 330	A4.236			60/97-2 ⤴ (2654403, 1447048M1)			
400, 410, 415	A4.300	60/161-38 (26510148, 1420377M91) Ht. 316mm ou /or 60/161-86 (2874126) Ht. 263mm		60/96-14 (26540153, 1883288M91)	60/111-5 ⊕ (26560017, 836218M91) = 60/111-3 ⇔ (26561117, 3405418M1)		60/574-14 * (577492M91)
487	A4.248			60/96-3 (26560090, 1896000M91)	60/111-3 ⇔ (26561117, 3405418M1)		
500, 510, 515	A6.354	60/161-38 (26510148, 1420377M91) Ht. 316mm ou /or 60/161-86 (2874126) Ht. 263mm		60/96-14 (26540153, 1883288M91) ou /or 60/97-3 ⤴ (2654407, 1447031M1)			60/240-7

Les références des pièces sont indicatives.
Nos pièces ne sont pas d'origine

Part numbers are quoted for reference purposes only.
Our parts and accessories are not original.

MF-186



"THE RELIABLE SERVICE"



Ed.1 (07/04)

FILTRATION FILTERS

⊙ CAV7111/296 ⇔ Repl.CAV296 ⊗ CAV796 ⚡ Repl.CAV796 ⤴ A visser/Spin on □ Cartouche/Cartridge H Dir assist./Power steering
 ⚡ Circuit auxiliaire/Auxiliary circuit * Refroidiss. d'huile/Oil cooler ⚡ Pompes hyd. interne/ Internal hydr. pump ⤴ Circuit ext./ External circuit

		1		2	3	4	
Tracteurs Tractors	Moteur Engine	Air		Huile Oil	Combustible Fuel	Hydraulique / Hydraulic	
		Ext. / Out.	Int. / Inn.			Relev. / Lift	
Moissonneuses-batteuses / Combines							
520, 525 620, 625	A6.354 A6.372	60/161-38 (26510148, 1420377M91)		60/96-14 (26540153, 1883288M91) ou /or 60/97-3 ⤴ (2654407, 1447031M1)		60/240-29 (1851399M91)	
530, 535	A6.354.4			60/97-2 ⤴ (2654403, 1447048M1) ou /or 60/97-3 ⤴ (2654407, 1447031M1)	60/111-5 ⊙ (26560017, 836218M91) = 60/111-3 ⇔ (26561117, 3405418M1)	60/240-29 (1851399M91)	
560, 565, 660, 665	AT6.354.4	60/161-41 (26510235, 1042412M91)				Embryage Clutch 60/655-3 (1810539M91)	
740, 750 750	A6.372.4 AT6.354.4	60/161-41 (26510235, 1042412M91)	60/162-41 (1096475M91)				
760	AT6.354.4	60/161-60 (3638563M1) Ht. 394mm ou /or 60/161-41 (26510235, 1042412M91) Ht. 416mm	60/162-25 (26510228, 1093683M92) 60/162-41 (1096475M91)	60/97-3 ⤴ (2654407, 1447031M1)			60/574-14 * (577492M91)
788	A4.270			60/96-3 (26560090, 1896000M91)	60/111-1 (32327, 1850450M2) + 60/111-8 (30242, 1881632M91)		
800, 805, 810, 815	A6.354.4						
820, 825, 830, 835, 840, 845	AT6.354.4	60/161-41 (26510235, 1042412M91)				60/240-29 (1851399M91)	
850, 855	AT6.354.4	60/161-60 (3638563M1) Ht. 394mm ou /or 60/161-41 (26510235, 1042412M91) Ht. 416mm	60/162-25 (26510228, 1093683M92) 60/162-41 (1096475M91)	60/97-3 ⤴ (2654407, 1447031M1)	60/111-5 ⊙ (26560017, 836218M91) = 60/111-3 ⇔ (26561117, 3405418M1)		60/574-14 * (577492M91)
860, 865	AT6.354.4	60/161-41 (26510235, 1042412M91)	60/162-41 (1096475M91)	60/97-2 ⤴ (2654403, 1447048M1) ou /or 60/97-3 ⤴ (2654407, 1447031M1)			
7250	620D						
7252	620D	60/161-77 (3580723M1)	60/162-77 (3580724M1)	60/97-33 (V836662111)	60/111-6 ⊙ (26560602, 1896287M91) = 60/111-4 ⚡ (26566602, 3405419M1)		
7254, 7256	634D						
7274, 7276, 7278	645D			60/97-34 (3637652M1)			

Les références des pièces sont indicatives.
Nos pièces ne sont pas d'origine

Part numbers are quoted for reference purposes only.
Our parts and accessories are not original.



FILTRATION FILTERS

⊙ CAV7111/296 ⇔ Repl.CAV296 ⊗ CAV796 † Repl.CAV796 ⤴ A visser/Spin on □ Cartouche/Cartridge H Dir assist./Power steering
 Ⓢ Circuit auxiliaire/Auxiliary circuit * Refroidiss. d'huile/Oil cooler ⚙ Pompes hyd. interne/Internal hyd: pump ⚡ Circuit ext./External circuit

Tracteurs Tractors	Moteur Engine	1		2	3	4		
		Air		Huile Oil	Combustible Fuel	Hydraulique / Hydraulic		
		Ext. / Out.	Int. / Im.			Relev. / Lift		
Tracteurs industriels / Industrial tractors								
20B, 20E, 30E	AD3.152	60/161-12 (1688092M2)	60/162-12 (3824033M1)	60/97-1 ⤴ (2654408, 1447082M91)	60/111-5 ⊙ (26560017, 836218M91) = 60/111-3 ⇔ (26561117, 3405418M1)	60/655-3 * (1810539M91)	60/574-2 H (1052097M1)	
20D						ou / or 60/655-4 (1810694M92)	60/574-1 H (1886135M1)	
30D								
30H								60/574-4 H (1662566M1)
40								
40E						60/161-12 (1688092M2)	60/162-12 (3824033M1)	
50	AD4.203 A4.212 A4.236	60/161-3 (26510236, 880271M1)	60/162-3 (26510237, 1887575M91)	60/97-2 ⤴ (2654403, 1447048M1)	60/111-5 ⊙ (26560017, 836218M91) = 60/111-3 ⇔ (26561117, 3405418M1)	60/574-3 H (1883318M1) Ht. 62mm Ø 85mm ou / or 60/574-4 H (1662566M1) Ht. 74mm Ø 71mm		
50D						60/655-4 (1810694M92)	60/641-3 (1810950M91)	
50B	A4.236					60/655-1 * (191855M4)		
50H, 50HX						60/641-3 (1810950M91)	60/574-4 H (1662566M1)	
50E 50EX	A4.236 A4.248	60/161-78 (3824035M1)	60/162-78 (3824036M1)		60/111-6 ⊙ (26560602, 1896287M91) = 60/111-4 † (26566602, 3405419M1)	60/655-5 (1687647M1)		
60H	A4.248					60/641-3 (1810950M91)		
Fermec Séries 700, 800, 900 Series	1004.4 1004.4T 1004.40T	60/161-24 (3595503M1)	60/162-23 (3595501M1)		60/111-5 ⊙ (26560017, 836218M91) = 60/111-3 ⇔ (26561117, 3405418M1)			

Les références des pièces sont indicatives.
Nos pièces ne sont pas d'origine

Part numbers are quoted for reference purposes only.
Our parts and accessories are not original.

MF-188

"THE RELIABLE SERVICE"

Ed.1 (07/04)

**DIMENSIONS FILTRE
FILTER DIMENSIONS**

Réf. Ref.	Ø x H L x l x H	Filet Thread
60/161-1	104 x 232	
60/161-3	114 x 268	
60/161-12	174 x 315	
60/161-13	133 x 321	
60/161-14	180 x 359	
60/161-22	138 x 305	
60/161-23	177 x 282	
60/161-24	155 x 282	
60/161-25	177 x 394	
60/161-26	215 x 315	
60/161-27	212 x 330	
60/161-38	155 x 317	
60/161-41	174 x 416	
60/161-60	154 x 392	
60/161-63	127 x 238.5	
60/161-77	264 x 420	
60/161-78	132 x 327	
60/161-86	233 x 267	
60/161-95	114 x 365	
60/161-97	197 x 313	
60/161-98	67 x 120	
60/161-99	92 x 183	
60/161-100	127 x 274	
60/161-104	215 x 385	
60/161-105	202 x 420	
60/161-118	125 x 320	
60/161-119	149 x 360	
60/161-120	155 x 347	
60/161-121	194 x 400	
60/161-124	152 x 280	
60/161-125	282 x 520	
60/161-126	277 x 380	
60/161-127	265 x 420	
60/161-142	180 x 292	
60/161-143	142 x 330	
60/161-153	165 x 344	
60/161-165	220 x 403	
60/162-1	72 x 203	
60/162-3	52 x 220	
60/162-12	74 x 213	
60/162-13	75 x 294	
60/162-14	90 x 194	
60/162-22	60 x 197	
60/162-23	85 x 230	
60/162-25	86 x 358	
60/162-26	133 x 280	
60/162-27	117 x 330	

Réf. Ref.	Ø x H L x l x H	Filet Thread
60/162-41	103 x 282	
60/162-64	118 x 405	
60/162-77	151 x 381	
60/162-78	75 x 187	
60/162-97	112 x 287	
60/162-98	65 x 210	
60/162-99	89 x 198	
60/162-118	65 x 305	
60/162-119	75 x 345	
60/162-120	88 x 360	
60/162-121	105 x 385	
60/162-124	148 x 320	
60/162-125	150 x 500	
60/162-126	148 x 372	
60/162-127	150 x 370	
60/162-142	66 x 254	
60/162-143	84 x 319	
60/162-153	95 x 339	
60/162-165	114 x 382	
60/96-1	71 x 141	
60/96-2	65 x 115	
60/96-3	71 x 156	
60/96-14	95 x 116	
60/96-15	95 x 100	
60/97-61	140 x 175	1/2" - 16
60/97-1	76 x 142	3/4" - 16
60/97-2	93 x 143	3/4" - 16
60/97-3	93 x 173	3/4" - 16
60/97-33	110 x 149	M24X1.5
60/97-34	106 x 272	M30x1,5
60/97-43	93 x 117	13/16" - 16
60/111-1	71 x 87	
60/111-2	80 x 71	
60/111-3	86 x 72	
60/111-4	84 x 112	
60/111-5	86 x 72	
60/111-6	84 x 112	
60/111-8	71 x 79	
60/111-25	84 x 160	
60/111-63	84 x 160	
60/111-202	84 x 188	
60/240-7	93 x 144	
60/240-22	80 x 185	
60/240-23	74 x 154	
60/240-24	70 x 80	
60/240-25	60 x 119	
60/240-26	70 x 129	
60/240-27	63 x 68	

Réf. Ref.	Ø x H L x l x H	Filet Thread
60/240-28	103 x 177	
60/240-29	129 x 228	
60/240-39	127 x 139	
60/240-40	79 x 204	
60/240-41	50 x 155	
60/240-61	138 x 238	
60/240-85	x 98	
60/569-1	98 x 238	
60/574-1	50 x 40	
60/574-2	38 x 52	
60/574-3	86 x 63	
60/574-4	71 x 74	
60/574-7	50 x 205	
60/574-14	111 x 180	
60/574-21	84 x 56	
60/574-25	84 x 54.5	
60/574-26	47 x 99	
60/625-1	63 x 93	
60/625-2	60 x 96	
60/625-4	55 x 120	
60/625-5	140 x 166	
60/625-6	136 x 98	M42x2
60/625-7	137 x 240	
60/625-9	138 x 171	
60/625-11	109 x 170	
60/625-14	63.5 x 127.5	
60/641-3	135 x 228	
60/641-26	80 x 153	
60/641-27	55 x 100	
60/655-1	47 x 116	
60/655-2	44 x 88	
60/655-3	71 x 153	
60/655-4	72 x 160	
60/655-5	50 x 152	
60/4200-25	840 x 130 x 55	
60/4200-28	235 x 85 x 48	
60/4200-30	600 x 81 x 51	
60/4200-31	600 x 80 x 50	
60/4200-32	760 x 152 x 57	
60/4200-33	760 x 152 x 57	
60/4200-34	840 x 130 x 55	
60/4200-35	510 x 275 x 70	
60/4200-36	510 x 275 x 70	
60/4200-39	600 x 80 x 50	

ADAPTATEUR M42 / M42 ADAPTATOR

60/627-6
Pour filtres / For filtre :
60/625-5, 60/625-6 & 60/625-7



















Les références des pièces sont indicatives.
Nos pièces ne sont pas d'origine

Part numbers are quoted for reference purposes only.
Our parts and accessories are not original.



DURITES DE FILTRE À AIR
AIR FILTER HOSES

30/163-2 	30/163-3 	30/163-4 	30/163-7 	
30/163-8 	30/163-10 	30/163-12 	30/163-13 	30/163-14 
30/163-23 	30/163-24 	30/163-46 	30/163-47 	30/163-54 
30/163-55/58 	30/163-59 	30/163-60 		

Tracteurs Tractors	Réf. Ref.	OEM	Type
Tracteurs français, anglais & américains / French, UK & USA tractors			
25, 122, 130, 825	30/163-47	966558M1	Bain d'huile / Oil bath
FE35 (4 Cyl.)	30/163-23	827080M1	Bain d'huile / Oil bath
	30/163-24	1884897M1	
35 (3 Cyl.)	30/163-2	890258M1	Bain d'huile / Oil bath
133, 135, 140, 145, 148, 230, 240, 250	30/163-3	898104M1	
135, 148, 230, 240, 250	30/163-4	1861746M1	Filtre sec / Dry filter
155, 158	30/163-46	906501M2	
165MKIII, 175, 178, 185, 188	30/163-12	883680M1	
165, 168, 185	30/163-10	884545M1	
165	30/163-8	883686M1	Bain d'huile / Oil bath
165	30/163-7	883685M1	
265, 275, 285, 290, 390E	30/163-13	1686294M1	Filtre sec / Dry filter
265, 275, 285, 290, 565, 575, 590	30/163-59	1876307M1	
265, 275, 290, 375E, 390E	30/163-14	1682648M1	
550	30/163-54	1876063M1	
IT Tracteurs italiens / Italian tractors			
134, 154, 233, 234, 244, 253, 254, 333, 334, 353, 354	30/163-55	1433260M2	Bain d'huile / Oil bath
134, 154, 174, 184, 194, 233, 234, 253, 254, 263, 264, 273, 274, 283, 284, 293, 294, 333, 353, 363, 364, 373, 376, 383, 393	30/163-60	1434732M2	
174, 184, 194, 273, 274, 283, 284, 293, 294, 373, 374, 376, 383, 384, 393, 394, 396	30/163-58	1824647M2	

Les références des pièces sont indicatives.
Nos pièces ne sont pas d'origine



Part numbers are quoted for reference purposes only.
Our parts and accessories are not original.



"THE RELIABLE SERVICE"



FILTRES A AIR - BAIN D'HUILE
AIR FILTERS - OIL BATH

	Filtre complet <i>Complete filter</i>	Element <i>Element</i>	Fig.
35, 135, 240, 250, 550	60/158-5 (3824173M91)	60/159-4 (35211, 1883116M91) <i>AC Delco Ø136</i> 60/159-5 (1886670M1) <i>Burgess Ø156</i>	
65, 165 MKIII, 168, 175, 185, 188	60/158-6 (964217M1)	60/159-6 (30480, 1883398M1)	

CAPUCHONS POUR FILTRE A AIR
AIR FILTER CAPS

Tracteurs <i>Tractors</i>	Préfiltre complet <i>Complete filter</i>	OEM	A " / mm	B " / mm
35, 135, 140, 148, 240, 250 <i>Pour filtres à air à bain d'huile</i> <i>For oil bath air cleaners</i>	30/169-17	1850293M92, 1884301M91	2" 51	6 ^{1/2} " 165
	30/169-15	893226M91, 969945M91, 1884302M91	2" 51	14" 355
260, 265, 275, 275E, 285, 290, 290E, 375E, 390E, 550, 560, 565, 575, 590, 675, 690 <i>Italien / Italian</i> 254, 254S, 264T, 274, 274S, 284, 294 <i>Pour filtres à air sec</i> <i>For dry air cleaners</i>	30/169-16	1679693M91, 1874894M92	2 ^{1/2} " 63	12" 305









Réf. <i>Ref.</i>	A mm	B mm	C mm
60/160-1	51	152	85
60/160-2	64	152	85
60/160-3	68	136	57
60/160-4	76	152	85
60/160-5	95	292	130
60/160-6	101	292	128

Les références des pièces sont indicatives.
Nos pièces ne sont pas d'origine

*Part numbers are quoted for reference purposes only.
Our parts and accessories are not original.*

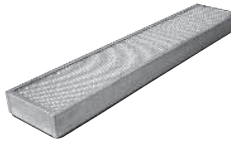

**FILTRES DE CABINES
CAB FILTERS**

Tracteurs Tractors	Réf. Ref.	OEM	Illustration	Dimension
342, 350, 352, 355, 360, 362, 365, 372, 375, 382, 390, 396, 398, 399	60/4200-35	3478327M1		510x275x70
	60/4200-36 Charbon actif Active charcoal	3614023M91		
Série 300 italienne 300 italian series 1007, 1014, 1024	60/4200-30	3302666M92		235x85x48
	60/4200-28 Charbon actif Active charcoal	3311741M92		
362 N, 372 N, 375, 382 N, 390, 390 T, 396, 398, 399	60/4200-31	3478477M91		600x81x51
	60/4200-39 Charbon actif Active charcoal	3614022M92		
550, 560, 565, 575, 590, 592, 595, 595 MKII	60/4200-32	1877242M2		300x150x55
2620, 2625, 2640, 2645, 2680, 2685, 2720, 2725	60/4200-33	3380431M1		300x150x55
Série 3000, 3100, 3600, 4200, 4300, 6100, 6200, 8100, 8200 serie	60/4200-25	3388840M2		840x130x55
	60/4200-34 Charbon actif Active charcoal	3389746M1		

FILTRES A HUILE COMPLET ET TETES / OIL FILTERS HEAD AND ASSEMBLY

35, 65, 133, 135, 148

60/95-1
(2654026,
1477082M91+
741922M1)



35, 65, 133, 134, 135, 145, 148, 152,
154, 165, 233, 234, 235, 240, 245, 250,
253, 254, 255, 333, 334, 356, 550

60/98-1
(37764251,
741922M1)



165, 168, 174, 175, 184, 185, 188, 194, 265,
273, 274, 275, 283, 284, 285, 290, 293, 294,
367, 373, 374, 375, 376, 377, 383, 384, 387,
390, 393, 394, 396, 397, 565, 575, 590, 675,
690, 1200

60/98-2
(37764181,
741614M1)



Les références des pièces sont indicatives.
Nos pièces ne sont pas d'origine

Part numbers are quoted for reference purposes only.
Our parts and accessories are not original.



PREFILTRES A AIR
AIR PRECLEANERS



Fig.		1					2	3
Tracteurs Tractors	Préfiltre complet Complete filter	Fig.	A mm	B mm	C mm	D " / mm	Couvercle Cap	Cuve Bowl
133, 135, 140, 145, 148	60/168-24 (963115M2)	1-1	174	250	360	51 mm 2"	60/168-19A (1804690M1)	60/169-19 (1804689M1)
155, 158, 165, 178	60/168-23 (960347M1)		174	300	413	57 mm 2 ^{1/4} "		
Suivant montage / <i>Some fittings</i>	60/168-22		174			72 mm		
230, 240, 250, 253, 263, 265, 275, 285, 290, 290E, 298, 340, 342, 350, 352, 355, 360, 362N, 372N, 375, 375E, 382N, 390E	60/168-17 (1687562M1, 1682798M1)		160		150	64 mm 2 ^{1/2} "		60/169-12 (3473919M1, 1897117M1)
	60/168-14 (3761802M1)		182					
365, 375, 390, 396, 398, 399, 698T, 699, 1004T, 3050, 3060, 3065, 3070, 3075, 3080, 3090, 3095, 3115, 6120, 6130, 6140, 6150, 6160, 6170, 6180	60/168-6 (1693129M1)	1-2	186			76 mm 3"	60/168-3A (1508880M91)	60/169-6 (1508881M1) Ø 180 mm
2640, 2645, 2680, 2685, 2720, 2725	60/168-7 (3380636M1, 2708734M91)		269			102 mm 4"		
1080 Moissonneuses-batteuses / <i>Combines</i> 410, 415, 500, 507, 510, 515, 520, 525, 530, 535, 620, 625, 750, 800, 805, 810, 815	60/168-4 (907462M94, 230654M91, 3371936M91, 3699806M91)		269			76 mm 3"	60/168-4A (1018551M91)	60/169-4
	60/168-16 <i>Economique</i> <i>Economic</i>							60/169-11
	Vortex-Turbo 60/168-50	1-3				96 mm 3 ^{3/4} "		
	Vortex-Turbo 60/168-51					102 mm 4"		



Les références des pièces sont indicatives.
Nos pièces ne sont pas d'origine

Part numbers are quoted for reference purposes only.
Our parts and accessories are not original.

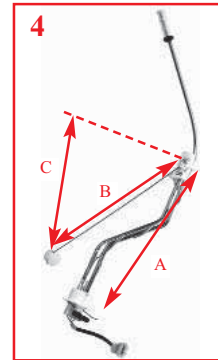
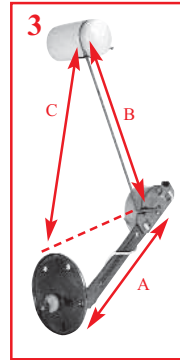
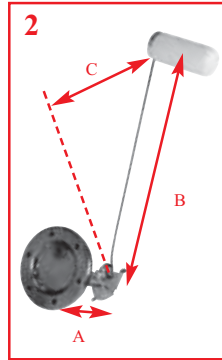
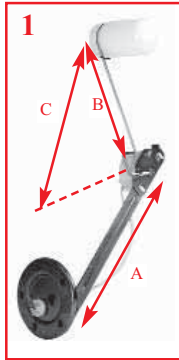

**FLOTTEURS DE RESERVOIR
FUEL SENDER UNITS**



Tracteurs Tractors	Fig.	Réf. Ref.	OEM	Remarque Observation	
133, 135, 140  20D, 40	1	30/172-1	897403M91	A : 160mm - B : 80mm C : 110mm - 5 trous / holes	
135, 148		30/172-2	1861789M91	A : 150mm - B : 140mm C : 200mm - 5 trous / holes	
133, 135, 140, 145, 148, 152F/S/V, 152MKIII		30/172-32	962386M3	A : 150mm - B : 115mm C : 170mm - 5 trous / holes	
134, 154 /C, 165, 168, 174 /C, 184, 185, 188, 194 /C, 233, 234S, 253, 254 /S, 263T, 264 /T/S, 273, 374 /S, 283, 284, 293, 294	2	30/172-30	1825031M91	A : 165mm - B : 220mm C : 290mm - 6 trous / holes	
		30/172-31	908600M1	A : 100mm - B : 160mm C : 220mm - 5 trous / holes	
155, 158	3	30/172-9	962384M3	A : 110mm - B : 165mm C : 230mm - 5 trous / holes	
165, 168, 175, 178, 185, 188  30D/E, 50/B/BMKII	2	30/172-3	897389M91	A : 95mm - B : 160mm C : 240mm - 5 trous / holes	
168, 261, 265, 275, 290, 298, 375E, 390E  50D/E/EX/H/HX, 60H/HX		30/172-8	1678517M2	A : 155mm - B : 160mm C : 230mm - 6 trous / holes	
240, 250		30/172-7	1661794M92	A : 100mm - B : 145mm C : 220mm - 6 trous / holes	
333, 353, 363, 373, 383, 393		30/172-28	3530230M92	A : 130mm - B : 255mm C : 360mm - 6 trous / holes	
340, 342, 350, 352, 355, 360, 362		30/172-39	3762579M1	A : 40mm - B : 150mm C : 140mm - 0 trous / holes	
362N, 372N, 382N		30/172-40	3762580M1	A : 40mm - B : 180mm C : 175mm - 0 trous / holes	
365, 375, 390, 390T, 398 (B18009 ⇒)		4	30/172-41	3762526M91	A : 380mm - B : 355mm C : 485mm - 0 trous / holes
			30/172-42	3762527M91	A : 330mm - B : 405mm C : 580mm - 0 trous / holes
550		1	30/172-10	1667409M91	A : 90mm - B : 200mm C : 280mm - 6 trous / holes
565			30/172-11	1613684M92	A : 125mm - B : 310mm C : 445mm - 6 trous / holes
575, 590, 592, 595, 595MKII	30/172-12		1613002M3	A : 125mm - B : 410mm C : 590mm - 6 trous / holes	
675, 690, 698, 699, 1004 /T	2	30/172-13	1678518M2	A : 155mm - B : 210mm C : 300mm - 6 trous / holes	
1014, 1024		30/172-37	3301628M91	A : 190mm - B : 280mm C : 390mm - 6 trous / holes	
1114, 1134		30/172-36	3301268M91	A : 290mm - B : 290mm C : 420mm - 6 trous / holes	

Les références des pièces sont indicatives.
Nos pièces ne sont pas d'origine



"THE RELIABLE SERVICE"



Part numbers are quoted for reference purposes only.
Our parts and accessories are not original.

**FLOTTEURS DE RESERVOIR
FUEL SENDER UNITS**

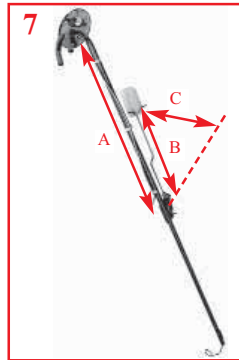
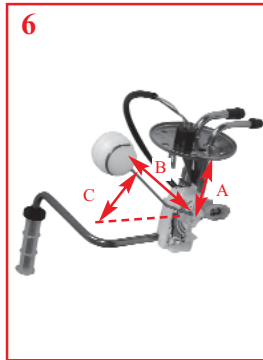
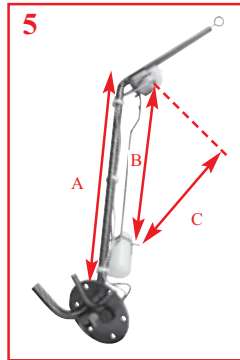

Tracteurs Tractors	Fig.	Réf. Ref.	OEM	Remarque Observation
3050, 3060, 3065	5	30/172-33	3388604M91	A : 300mm - B : 250mm C : 400mm - 6 trous / holes
3070, 3075, 3080, 3085, 3090, 3095, 3115, 3120		30/172-34	3388605M93	A : 380mm - B : 250mm C : 360mm - 6 trous / holes
3610, 3630, 3635, 3645, 3650, 3655		30/172-35	3388606M92	A : 390mm - B : 240mm C : 390mm - 6 trous / holes
3635, 3645, 3655	7	30/172-43	3582876M1	A : 240mm - B : 180mm C : 260mm - 6 trous / holes <i>Réservoir suppl. / Additional tank</i>
4215, 4220, 4225, 4315, 4320, 4325 <i>Cabine basse / Low profile cab</i>	6	30/172-44	3807655M92	A : 80mm - B : 130mm C : 130mm - 6 trous / holes
4235, 4245, 4255, 4265, 4335, 4345, 4355 <i>Cabine basse / Low profile cab</i>		30/172-45	3807654M92	A : 95mm - B : 145mm C : 155mm - 6 trous / holes
4225, 4235, 4240, 4245, 4255, 4265, 4325, 4335, 4345, 4355, 4360, 4365, 4370 <i>Cabine haute / High profile cab</i>		30/172-46	3807653M92	A : 120mm - B : 140mm C : 180mm - 6 trous / holes
4260, 4265, 4270, 4360, 4365, 4370		30/172-47	3809967M92	A : 120mm - B : 180mm C : 310mm - 6 trous / holes
Séries 6100, 6200 series	5	30/172-48	3787791M1	A : 380mm - B : 225mm - C : 310mm - 6 trous / holes <i>Réservoir principal 130L (sans réservoir suppl.) Main tank 130L (Without additional tank)</i>
		30/172-56	3787790M1	A : 370mm - B : 220mm - C : 340mm - 6 trous / holes <i>Réservoir principal 160L (sans réservoir suppl.) Main tank 160L (Without additional tank)</i>
	7	30/172-49	3714733M2	A : 355mm - B : 260mm - C : 365mm - 6 trous / holes <i>Réservoir principal (avec réservoir suppl.) Main tank (With additional tank)</i>
8110, 8120, 8130	5	30/172-50	3715286M4	A : 240mm - B : 180mm - C : 260mm - 6 trous / holes <i>Réservoir suppl. / Additional tank</i>
		30/172-51	3713028M1	A : 355mm - B : 250mm - C : 415mm - 6 trous / holes <i>Réservoir principal (sans réservoir suppl.) Main tank (Without additional tank)</i>
	7	30/172-52	3713029M1	A : 350mm - B : 245mm - C : 405mm - 6 trous / holes <i>Réservoir principal (avec réservoir suppl.) Main tank (With additional tank)</i>
8140, 8150, 8160	7	30/172-43	3582876M1	A : 240mm - B : 180mm - C : 260mm - 6 trous / holes <i>Réservoir suppl. / Additional tank</i>
		30/172-54	3712952M1	A : 420mm - B : 270mm - C : 380mm - 6 trous / holes <i>Réservoir principal (sans réservoir suppl.) Main tank (Without additional tank)</i>
	7	30/172-55	3713084M1	A : 420mm - B : 250mm - C : 370mm - 6 trous / holes <i>Réservoir principal (avec réservoir suppl.) Main tank (With additional tank)</i>
		30/172-43	3582876M1	A : 240mm - B : 180mm - C : 260mm - 6 trous / holes <i>Réservoir suppl. / Additional tank</i>

Les références des pièces sont indicatives.
Nos pièces ne sont pas d'origine

Part numbers are quoted for reference purposes only.
Our parts and accessories are not original.



INSTRUMENTATION INSTRUMENTS

Ampèremètres / Ammeters

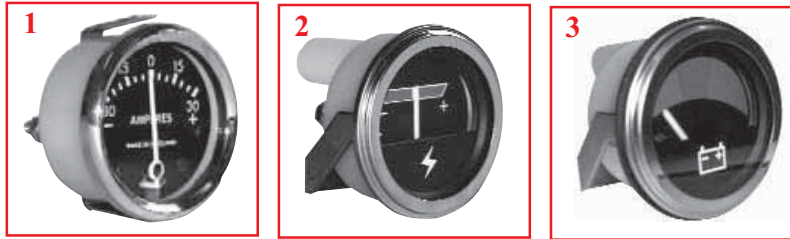

Tracteurs Tractors	Fig.	Réf. Ref.	OEM	Remarque Observation
TE20, 35, 65, 135, 148, 165, 175, 178	1	30/170-1	827055M1	Montage LUCAS fitting Vis / Screw - Ø40
Tracteurs français 25 ⇒ 188 French tractors 25 ⇒ 188	2	30/170-3	908430M1	Montage OS/JAEGER/AST fitting Vis / Screw - Ø 52mm
230, 240, 250, 253, 263 20E, 20F, 30E, 40E,	3	30/170-4	1672835M2	Fiches / Plugs - Ø 52mm

Indicateurs de température / Temperature gauges



Tracteurs Tractors	Fig.	Réf. Ref.	OEM	Remarque Observation
TE20, 35, 35X, 65, 135, 148, 165, 168, 175, 178, 185, 188, 1200, 1250 30D/E, 40, 50	1	30/174-1	881396M91	Ø 52mm - Lg 1750mm Capillaire / Tube - 5/8" UNF
158, 235, 240, 245, 250, 255, 260, 265, 275, 285, 290, 298, 550, 560, 565, 575, 590, 592, 595, 595MKII, 1080, 2775, 2805 2620, 2640, 2680 (⇒ S271213) 20E, 50	2	30/174-2	1877719M93	Ø 52mm Avec indicateur électrique With electrical gauge
1104	3	30/174-17	1822732M93	Ø 52mm - Lg 2050mm Capillaire / Tube - 5/8" UNF
134V, 154 V/F, 164 /TF/TS/TV, 174V, 184F, 194 /F/S, 233, 234CF, 244CF, 253, 254CF, 263T, 264 T/TCF/TS, 274 C/CF/SK, 283, 284, 293, 294 /C/S, 364CF, 394C, 675, 690, 698, 699, 1004, 1014, 1024, 1114, 1134	4	30/174-11	3305408M93	Ø 85mm Avec niveau de carburant With fuel gauge

Les références des pièces sont indicatives.
Nos pièces ne sont pas d'origine

Part numbers are quoted for reference purposes only.
Our parts and accessories are not original.



INSTRUMENTATION INSTRUMENTS

Jauges de carburant / Fuel gauges

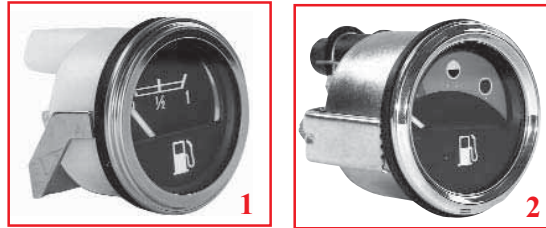

Tracteurs Tractors	Fig.	Réf. Ref.	OEM	Remarque Observation
133, 135 /V, 135MKIII, 140, 145 /V/S, 145MKIII, 148, 148MKIII, 152 /F/V/S, 152MKIII, 155, 158 /F/S/V, 158MKIII, 165, 165MKIII, 168 /F/S, 168MKIII, 175, 178, 185, 188, 230, 231, 235, 240, 240S, 245, 250, 253, 255, 260, 261, 263, 265 /S, 275, 285 /S, 290, 298, 375E, 390E, 550, 560, 565, 575, 590, 592, 595, 595MKII, 2620, 2640, 2680, 2725, 2805 20B/D, 30D/E, 40, 50/B/BMKII/D 410, 510, 515, 520, 525	1	30/171-1	894844M1	Ø 52mm
	2	30/171-3	1877717M93	

Jauges de pression d'huile / Oil gauges



Tracteurs Tractors	Fig.	Réf. Ref.	OEM	Remarque Observation
TE20, 35, 65, 135, 148, 165, 168, 175, 175S, 178, 185, 188, 765, 1200, 1250 30D/E, 50/B/BMKII/D 410, 415, 510, 515, 520, 525, 620, 625, 788	1	30/173-1	1853094M1	Ø 51mm
133, 135, 135MKIII, 135V, 140, 145, 145V/S, 148MKIII, 152, 152MKIII, 152F/V/S, 155, 158, 158MKIII, 158F/V/S, 165, 165MKIII, 168MKIII, 168, 168F/S, 178, 185, 188, 1080	2	30/173-3	3381907M1	Ø 51mm
1104	3	30/173-4	973085M93	Ø 51mm

Les références des pièces sont indicatives.
Nos pièces ne sont pas d'origine

Part numbers are quoted for reference purposes only.
Our parts and accessories are not original.



INSTRUMENTATION INSTRUMENTS

Tractomètres / Tractometer

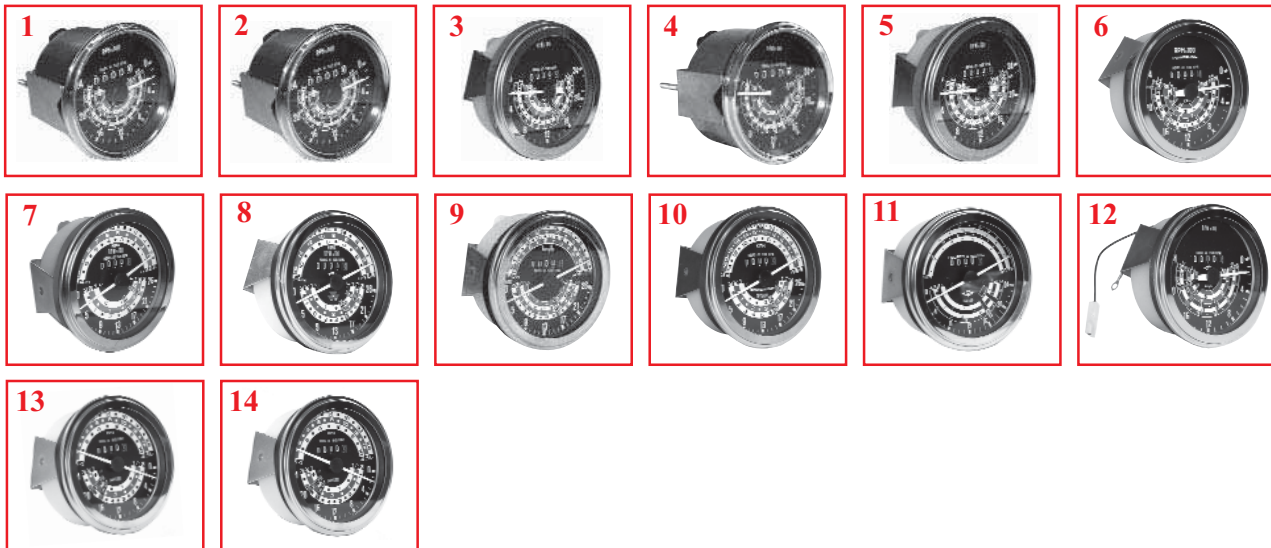

Tracteurs Tractors	Fig.	Réf. Ref.	OEM	Remarque Observation
FE35 (4 cyl.) (⇒ 307657)	1	30/175-1	1850093M93	MPH - Ø88mm Rotation droite / RH rotation
	2	30/176-1	1850092M93	KPH - Ø88mm Rotation droite / RH rotation
35, 35X (A3.152) (⇒ 307657)	3	30/175-3	890421M92	MPH - Ø85mm Rotation gauche / LH rotation
	4	30/176-3	890223M92	KPH - Ø85mm Rotation gauche / LH rotation
35, 35X (A3.152) (307657 ⇒)	5	30/176-4	894429M91	KPH - Ø85mm Rotation droite / RH rotation
65, 765	6	30/176-32	894432M91	KPH - Ø88mm Rotation droite / RH rotation
135 6 vitesses - Embrayage double / 6 gear - Double clutch	7	30/175-9	898465M91	MPH - Ø88mm Rotation gauche / LH rotation
	8	30/176-9	899423M91	KPH - Ø88mm Rotation gauche / LH rotation
135, 148 8 vitesses / 8 gear	9	30/176-11	1860018M91 1860059M91	KPH - Ø88mm Rotation gauche / LH rotation
135, 148 Multipower	10	30/176-10	899657M92	KPH - Ø88mm Rotation gauche / LH rotation
133, 135, 140, 145, 148, 152	11	30/176-34	3381904M1	KPH - Ø88mm Rotation gauche / LH rotation
155, 158, 165MKIII, 168, 178, 185, 188	12	30/176-33	908467M1	KPH - Ø88mm Rotation droite / RH rotation
165, 168, 175 /S, 178, 185, 188 6 vitesses / 6 gear 50	13	30/175-12	898487M92	MPH - Ø88mm Rotation droite / RH rotation
	14	30/176-12	899421M91	KPH - Ø88mm Rotation droite / RH rotation

Les références des pièces sont indicatives.
Nos pièces ne sont pas d'origine

Part numbers are quoted for reference purposes only.
Our parts and accessories are not original.



INSTRUMENTATION INSTRUMENTS

Tractomètres / Tractometer



Tracteurs Tractors	Fig.	Réf. Ref.	OEM	Remarque Observation
155, 158, 165, 168, 185, 188 <i>8 vitesses / 8 gear</i> 30D/E	15	30/176-14	1860065M91	KPH - Ø88mm Rotation droite / RH rotation
133, 135, 140, 155, 165, 168, 175 /S, 178, 185, 188 <i>Multipower</i> 30D/E	16	30/175-13	898489M91 898491M92	MPH - 88mm Rotation droite / RH rotation
	17	30/176-13	899663M91	KPH - Ø88mm Rotation droite / RH rotation
133, 135, 140, 145 <i>Multipower</i>	18	30/176-35	908463M1	KPH - Ø88mm Rotation gauche / LH rotation
134V, 154F/S/V, 164TF/TS/TV, 174F/S/V, 184F/S, 194C/F/S, 233, 234CF, 244CF, 253, 254CF, 263T, 264T/TCF/TS, 273, 274C/CF/SK, 284, 293, 294 /C/S, 364CF, 394C	19	30/176-31	3308251M92	KPH - Ø85mm Rotation droite / RH rotation
158, 168 <i>12 vitesses / 12 speed</i> 240, 253, 260, 261, 263, 265 /S, 275, 285 /S, 290/S, 298, 375E, 390E, 560, 565, 575, 590, 592, 595 50	20	30/176-16	1674637M92	KPH - Ø88mm Rotation droite / RH rotation
230, 231, 240 /S, 245, 250, 253, 255, 550 40	21	30/176-15	1674638M92	KPH - Ø85mm Rotation gauche / LH rotation
334V, 353, 354, 363, 364, 373, 374, 377, 383, 384, 387, 393, 394, 397, 1007	22	30/176-38	3311406M91	KPH Rotation droite / RH rotation
675, 690, 698, 698T, 699, 1004, 1004T	23	30/176-26	3305407M92	KPH - Ø85mm Rotation droite / RH rotation
1014, 1024, 1114, 1134	24	30/176-36	3530293M92	KPH - Ø84.5mm Rotation droite / RH rotation
2640, 2645, 2680, 2685, 2720, 2725	25	30/176-27	3381409M1	KPH - Ø80mm Rotation droite / RH rotation

Les références des pièces sont indicatives.
Nos pièces ne sont pas d'origine

Part numbers are quoted for reference purposes only.
Our parts and accessories are not original.



INSTRUMENTATION INSTRUMENTS

Entraîneurs de tractomètre / *Tachometer drive units*

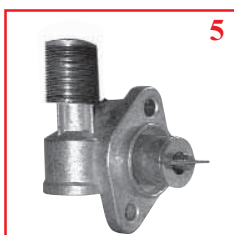
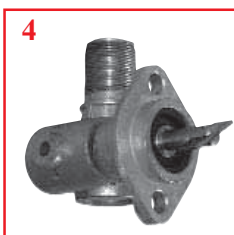
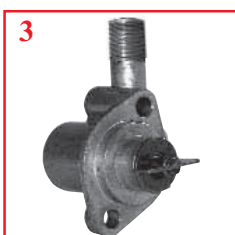
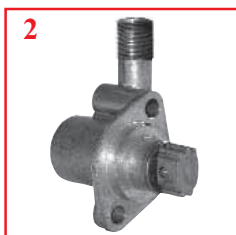

Tracteurs <i>Tractors</i>	Fig.	Réf. <i>Ref.</i>	OEM	Remarque <i>Observation</i>
265 /S, 275, 285 /S, 290, 565, 575, 590, 592, 595, 1080, 1150, 1155	1	30/58-18	520909M1	Filetage / <i>Thread</i> : 1/2" - 7/8"
35, 35X	2	30/58-1	829489M91	Filetage / <i>Thread</i> : 1/2"
134 C/N, 154 /C/F/S/V, 164T F/S/V, 165, 165MKIII, 168 /S, 168MKIII, 174 /C/F/S/V, 175 /S, 178, 184 /F/S, 185, 188, 194 /C/F/S, 240, 253, 263, 275, 290 /E, 362 /N, 365, 375 /E, 382N, 390 /E/T, 398, 565, 575, 590, 592, 595, 675, 690, 698 /T, 699, 1004 /T, 1104, 1080	3	30/58-2	1853144M1	Filetage / <i>Thread</i> : 1/2"
1014, 1024, 1114, 1134, 1250	4	30/58-7	1447481M91	Filetage / <i>Thread</i> : 3/4"
1085, 1155, Série 2600 <i>series</i> 2705, 2720, 2725, 2745, 2775, 2805	5	30/58-8	535126M93	Filetage / <i>Thread</i> : 7/8"

Commande de transmission flexible / *Flexible drive*

Bague d'étanchéité de la commande de la transmission flexible arrière sans renvoi d'angle

Flexible drive seal (Without angle drive)

Tous modèles 3 cyl. / *All 3 cyl. models*

65, 133, 135, 140, 145, 148, 152, 155, 158, 165, 235, 240, 245, 250, 260, 550, 560

30/57-1
(636762M1)



7/8" x 1 3/8" x 1/4"

Les références des pièces sont indicatives.
Nos pièces ne sont pas d'origine

*Part numbers are quoted for reference purposes only.
Our parts and accessories are not original.*



**TRANSMISSION FLEXIBLE
FLEXIBLE DRIVE**

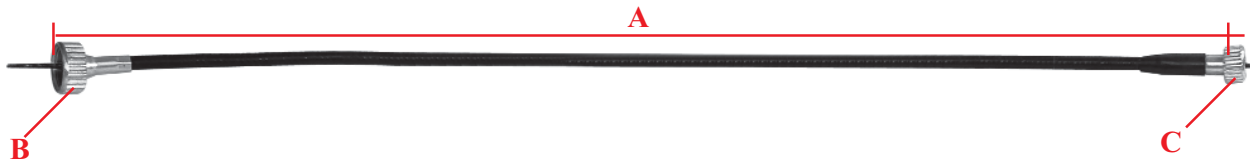

Tracteurs Tractors	Réf. Ref.	OEM	Remarque Observation
FE35	30/177-1	829487M91	A : 1230mm B : 1/2" C : 5/8" UNF
35, 35X, 135 20B/D/E/F, 30E, 40/E	30/177-2	890232M91	A : 620mm B : 7/8" C : 5/8" UNF
135 40	30/177-4	882539M91	A : 620mm B : 7/8" C : 5/8" UNF
65, 685, 765	30/177-3	967572M1	A : 690mm B : 7/8" C : 5/8" UNF
148	30/177-47	1861380M91	A : 635mm B : 7/8" C : 5/8" UNF
154, 164TF/TS/TV, 174, 184, 194 /C, 233, 234C/CF/S, 244CF, 253, 254C/CF/S, 263T, 264T, 273, 274 /C/CF/S/SK, 283, 284 /S, 293, 284 /C/S, 394	30/177-45	3308908M91	A : 2100mm B : 7/8" C : 5/8" UNF
165, 165MKIII, 168 /F/S, 168MKIII, 175 /S, 178, 185, 188, 240, 253, 261, 265, 275, 290, 565, 575, 590 30D/E, 50/E/EX	30/177-6	882021M91	A : 1355mm B : 1/2" C : 5/8" UNF
230, 240 /S, 245, 250, 253, 255, 260, 263, 350, 550 20B/D	30/177-5	1699381M92	A : 640mm B : 7/8" C : 5/8" UNF
240, 253, 263, 265S, 275E, 285S, 290E, 375E, 390E	30/177-51	1876289M91	A : 1265mm B : 7/8" C : 5/8" UNF
298, 295, 295MKII, 595	30/177-46	1873971M92	A : 1520mm B : 7/8" C : 5/8" UNF
675, 690, 698, 698T, 699, 1004, 1004T	30/177-11	3302472M91	A : 1570mm B : 1/2" C : 5/8" UNF
1104	30/177-52	1423262M92	A : 2000mm B : 1/2" C : M20x1.00
1014, 1024, 1114, 1134	30/177-53	1425872M91	A : 1500mm B : 3/4" C : M16x1.00
2620, 2625, 2640, 2645, 2675, 2680, 2685, 2705, 2720, 2725	30/177-12	3039521M91	A : 2100mm B : 7/8" C : 5/8" UNF

Les références des pièces sont indicatives.
Nos pièces ne sont pas d'origine

Part numbers are quoted for reference purposes only.
Our parts and accessories are not original.



**CONTACTEURS
SWITCHES**

Contacteurs combinés / Combined switches

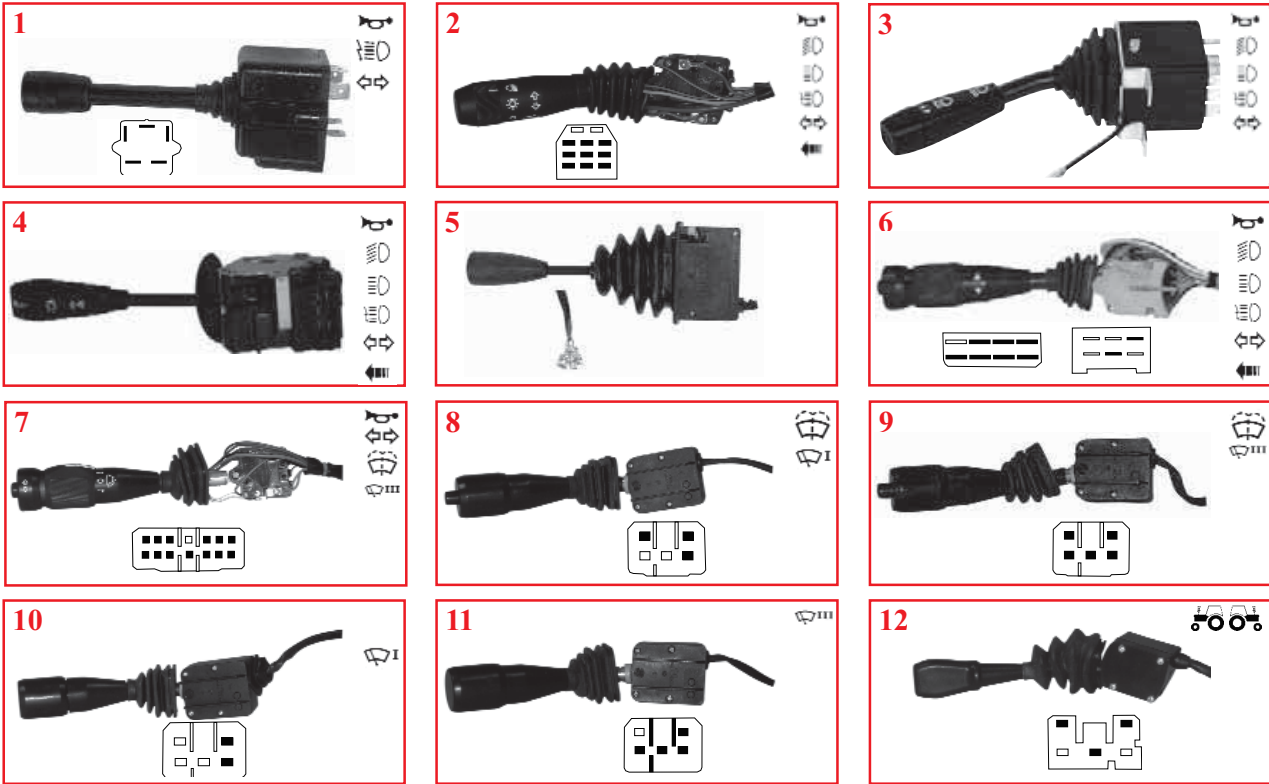

Tracteurs Tractors	Fig.	Réf. Ref.	OEM
134V, 154F/S/V, 164 TF/TS/TV, 174 F/S/V, 184 F/S, 194 F/S	1	30/958-37	3306612M93
2205, 2210, 2220, 2230	2	30/958-9	3554816M92
333, 334V, 356CF, 366CF, 367CF, 376C/CF/XCF, 377, 387, 393TLX, 394H, 394TAQ, 396C/CF/CT, 397, 397T, 1007 353, 363, 373, 383, 393/LX/S, 354, 374, 384, 394, 3210, 3220, 3225, 3235 AP(X)/FP(X)/GE(X)/SP(X) 354, 374, 384, 394 AP/AQ/F/FP/FQ/GE/S/SP/SQ/V/VQ	3	30/958-38	3533174M92
2620, 2625, 2640, 2645, 2680, 2685, 2720, 2725, 3050, 3060, 3065, 3070, 3075, 3080, 3085, 3090, 3095, 3115, 3120, 3125, 3610, 3630, 3635, 3645, 3650, 3655, 3670, 3680, 3690	4	30/958-36	3381403M1
3075, 3085, 3095, 3115, 3120, 3125, 3635, 3645, 3655, 3670, 3690 <i>Dynashift</i>	5	30/958-47	3618117M2
4215, 4220, 4225, 4235, 4240, 4245, 4255, 4260, 4265, 4270	6	30/958-5	3809592M91
6110, 6120, 6130, 6140, 6150, 6160, 6170	7	30/958-11	3713669M2
	8	30/958-32	3713668M4
	9	30/958-10	3713667M4
	10	30/958-33	3715838M4
	11	30/958-34	3715822M4
	12	30/958-35	3778904M1
6235, 6245, 6255, 6260, 6265, 6270, 6280, 6290	7	30/958-11	3713669M2
	10	30/958-33	3715838M4
	11	30/958-34	3715822M4
8110, 8120, 8130, 8140, 8150, 8160	7	30/958-11	3713669M2
	9	30/958-10	3713667M4
8170, 8180, 8210, 8220, 8240, 8250, 8260, 8270, 8280	11	30/958-34	3715822M4
	7	30/958-11	3713669M2

Les références des pièces sont indicatives.
Nos pièces ne sont pas d'origine

Part numbers are quoted for reference purposes only.
Our parts and accessories are not original.



CONTACTEURS SWITCHES

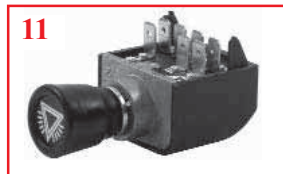
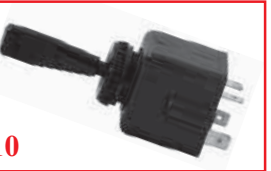
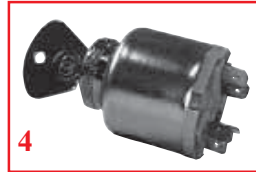
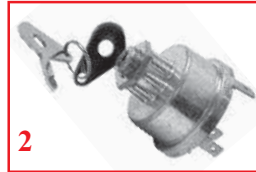

Tracteurs Tractors	Fig.	Réf. Ref.	OEM	Description
Contacteurs de démarrage / Starting switches				
35, 65, 135, 148, 165, 168, 175, 175S, 178, 185, 188, 765	1	30/950-1	883928M91	0 - Préchauffage - Démarrage (3 bornes) 0 - Heating - Start (3 terminals)
Séries 100, 200, 300, 500, 3000, 3100, 3200, 3300, 3600, 6100, 6200, 8100, 8200 series 1007, 2205, 2210, 2220	2	30/950-2	1874535M3	0 - Contact - Préchauffage - Démarrage (4 bornes) 0 - Ignition - Heating - Start (4 terminals)
Remplace clef de 30/950-1 & 30/950-2 Replacement keys for 30/950-1 & 30/950-2	3	30/951-2	3813361M1	Clef Key
Séries 100, 200 series (Italie / Italy) 1004, 1014, 1024, 1114, 1135	4	30/950-36	3302034M91	Préchauffage - 0 - Contact - Démarrage Heating - 0 - Ignition - Start
Contacteurs d'éclairage / light switches				
Séries 200, 500 series 133, 135, 140, 148, 152, 155, 158, 165, 168, 178, 185, 188, 2620, 2640, 2680	5	30/953-1	1668816M2	0 - Position - Croisement - Route + Claxon 0 - Parking - Traffic - Driving beams + Horn
		30/954-1	1668830M91	Bouton / Knob
Séries 100, 200 series	6	30/953-11	1825360M91	0 - Position - Croisement - Route + Claxon 0 - Parking - Traffic - Driving beams + Horn
1114, 1134	7	30/953-13	1425878M91	4 positions 4 positions
Séries 100, 200, 600 series (Italie / Italy) 675, 690, 698, 699, 1004, 1014, 1024, 1114, 1134	8	30/953-14	3300530M91	5 positions 5 positions
Contacteurs de clignotant / blinking light switches				
Séries 100, 200, 500, 4200, 4300 series 2620, 2640, 2680	9	30/956-1	881670M1	
Série 200 series 364, 394, 690, 698, 699, 1004, 1014, 1024, 1114, 1134	10	30/956-10	1424108M92	
Séries 100, 200, 500 series 2620, 2640, 2680	11	30/957-1	1671544M1	Commande feux de détresse Warning light control
230, 240, 250, 253, 263, 265, 275, 290, 298, 375, 390	12	30/956-11	1682977M1	Clignotants + feux de détresse + centrale clignotante Indicator + Warning light + blinking unit

Les références des pièces sont indicatives.
Nos pièces ne sont pas d'origine

Part numbers are quoted for reference purposes only.
Our parts and accessories are not original.



**CONTACTEURS
SWITCHES**



14



















15



16



17

Tracteurs Tractors	Fig.	Réf. Ref.	OEM	Description	
Indicateurs / Indicators					
154, 174, 184, 194, 234, 1114, 1134	14	30/973-2	1424103M92	Feux et clignoteurs <i>Light and indicators</i>	
134C, 154, 154C, 174, 174C, 184, 194, 234S, 254S, 274S, 1114, 1134	15	30/970-2	1825362M92	Pression d'huile et charge batterie <i>Oil pressure and battery</i>	
Séries 200, 500 series 375E, 390E	16	30/960-1	1663555M92	Tableau indicateur <i>Indicator pannel</i>	
Interrupteur de prise de force / PTO switch					
Séries 6100, 6200, 8100, 8200 series		30/954-4	3619445M2	 	
Bouton pour 30/954-4 <i>Knop for 30/954-4</i>		30/954-5	3619180M93		
Boutons poussoirs / Push switches					
Séries 300, 2200, 3600 series 2625, 2645, 2685, 2725, 3115, 3120, 3125	17	30/1884-52	3384575M1	Blocage du différentiel <i>Differential lock</i>	 
Séries 300, 2200, 3600 series 1007, 3115, 3120, 3125		30/1884-47	3388402M1	Relevage <i>Hydraulic lift</i>	 
Séries 2600, 2700, 3000, 3100, 3600 series		30/1884-48	3380337M91	Gamma	 
650, 660, 699 Séries 2600, 2700, 5300, 6100, 6200, 8100, 8200 series 530/S, 535, 560, 565, 660, 665, 800, 805, 810, 815, 820, 825, 830, 835, 840, 845		30/1884-53	3370427M91	Feux de détresse <i>Hazard</i>	 
Série 3600 series 3115, 3120, 3125		30/1884-49	3385822M1	4 RM 4 WD	 
Séries 6100, 6200, 8100, 8200 series		30/1884-50	3714137M1	Relevage <i>Hydraulic lift</i>	 
		30/1884-51	3714138M1		 

Les références des pièces sont indicatives.
Nos pièces ne sont pas d'origine

Part numbers are quoted for reference purposes only.
Our parts and accessories are not original.



CONTACTEURS SWITCHES

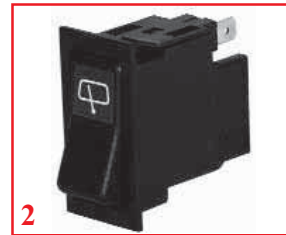

Tracteurs Tractors	Fig.	Réf. Ref.	OEM	Description	
Contacteurs à bascule / Rocker switches					
Série 300 series 1007	1	30/967-22	3533922M91	Eclairage 3 positions <i>Light - 3 positions</i>	
Série 300 (France & UK) series	2	30/967-52 (A)	1694358M1	Interrupteur général de l'éclairage <i>Lights</i>	
		30/967-53 (B)	3611533M1	Interrupteur général de l'éclairage <i>Lights</i>	
		30/967-54 (A)	1694359M1	Feux de croisement <i>Traffic beams</i>	
		30/967-55 (B)	3611536M1	Feux de croisement <i>Traffic beams</i>	
		30/967-56	1694362M1	Feux de travail arrière <i>Rear working lamps</i>	
		30/967-57 (A)	1695209M1	Feux de détresse <i>Hazard</i>	
		30/967-58 (B)	3611532M1	Feux de détresse <i>Hazard</i>	
		30/967-59	1694365M1	Ventilation <i>Fan</i>	
		30/967-60	1694361M1	Essuie-glace- Lave-glace <i>Wiper - Wiper washer</i>	

(A) Marchepied, avec cabine ⇒ P21356 / *Footstep, with cab ⇒ P21356*

(B) Avec cabine P21357 ⇒ / *With cab P21357 ⇒*

Les références des pièces sont indicatives.
Nos pièces ne sont pas d'origine

*Part numbers are quoted for reference purposes only.
Our parts and accessories are not original.*



CONTACTEURS SWITCHES















Tracteurs Tractors	Fig.	Réf. Ref.	OEM	Description	
Contacteurs à bascule / Rocker switches					
Séries 3000, 3100, 3600 series	1	30/967-23	3385758M92	Phare de travail droit <i>Working lamp RH</i>	
		30/967-24	3385760M92	Phare de travail gauche <i>Working lamp LH</i>	
		30/967-25	3581474M91	Feux de détresse <i>Hazard</i>	
		30/967-61	3385756M91	Gyrophare <i>Beacon</i>	
650, 660, Séries 4200, 4300, 5300, 6100, 6200, 8100, 8200 series	2	30/967-26	3809150M1	Interrupteur général de l'éclairage <i>Lights</i>	
		30/967-27	3809151M1	Feux de route <i>Driving beams</i>	
		30/967-28	3809490M2	Feux de cabine haute visibilité" <i>Cab beams "high visibility"</i>	
		30/967-29	3809491M2	Feux de travail arrière <i>Rear working lamps</i>	
		30/967-30	3809498M1	Feux de travail avant <i>Front working lamps</i>	
		30/967-31	3812275M1	Feux de croisement <i>Traffic beams</i>	
		30/967-32	3812271M1	Clignotant <i>Indicators</i>	
		30/967-33	3809149M1	Feux de détresse <i>Hazard</i>	
		30/967-34	3808918M2	Gyrophare <i>Beacon</i>	
		30/967-35	3809499M2	Lave-glace <i>Wiper washer</i>	
		30/967-36	3808919M2	Essuie-glace <i>Wiper</i>	
		30/967-37	3824042M1	Blocage du différentiel <i>Differential lock</i>	
		30/967-38	3824041M1	4X4 <i>4 WD</i>	
		30/967-39	3809797M2	Pont avant hydraulique <i>Hydraulic fwd axle</i>	
		30/967-40	3812633M1	Faisceau du relevage <i>Lift</i>	
		30/967-41	3902436M2	Relevage <i>Lift arm</i>	

Les références des pièces sont indicatives.
Nos pièces ne sont pas d'origine

*Part numbers are quoted for reference purposes only.
Our parts and accessories are not original.*



CONTACTEURS SWITCHES

















Tracteurs Tractors	Réf. Ref.	OEM	Description
Contacteurs stop / Stop switches			
Séries 200, 500 series	30/962-1	1874709M1	
Séries 200, 300 series	30/962-3	3596851M2	
Séries 100, 200, 300, 600 series 1004, 1007, 1014, 1024, 1114, 1134, 2205, 2210, 2220, 2230	30/962-9	1424104M92	
254, 274, 1114, 1134	30/962-10	3302937M91 1425168M92	
Contacteurs de sécurité / Safety switches			
Série 300 series 1007, 2205, 2210, 2220, 2230	30/187-24	3533170M91	
Séries 100, 200, 300, 500, 600, 2600, 2700 series 1004	30/187-1	963417M2	
265, 275, 290, 550, 565, 575, 590, 675, 690  30E/H, 40E, 50E/EX/H/HX, 60H  24, 25, 750, 760	30/187-2	1679223M2	
Séries italiennes 200 & 300 <i>Italian series</i> 1007, 1014, 1024, 1114, 1134	30/187-27	3304290M91	
Séries 3000, 3100, 3600, 6100, 8100 series 1004, 3115, 3120, 3125	30/187-25	3617693M1	
Séries 2600, 3000, 3600, 6100, 8100 series, 2720, 2725, 3115, 3120, 3125	30/187-26	3380073M1	Frein à main <i>Hand brake</i> 

Les références des pièces sont indicatives.
Nos pièces ne sont pas d'origine

*Part numbers are quoted for reference purposes only.
Our parts and accessories are not original.*

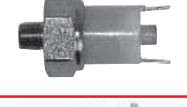

**CONTACTEURS
SWITCHES**

Tracteurs <i>Tractors</i>	Réf. Ref.	OEM	Description	
Contacteurs de pression d'huile / Oil pressure switches				
134C, 154/C, 233, 234C/S/T, 253, 254/C/S	30/186-16	1423896M91	Filet 3/8" - 1 fiche <i>Thread 3/8" - 1 plug</i>	
Séries 100, 200, 300, 500, 600, 2000, 2600, 2700, 3000, 3600, 4200, 4300, 6100, 6200, 8100, 8200 series 1004, 1004T, 1007, 1014, 1024, 3115, 3120, 3125  20D/F, 30E/H, 40E, 50E/EX/H/HX, 60H  24, 25, 750, 760	30/186-1	3599307M91 1877721M92	Filet 1/2" - 1 fiche <i>Thread 1/2" - 1 plug</i>	
Séries 200, 500, 600, 2600, 3000 series 2720, 2725, 3115, 3125	30/186-15	3381386M1	Filet 1/8" Basse pression <i>Thread 1/8" Low pressure</i>	
1014, 1024, 1134, 2210, 2220, 2235, 3315, 3325, 3330, 3340, 3350, 3355  8Plot, 10Plot, 16, 16Plot, 20, 24, 27, 29XP, 31, 31XP, 330, 430  8925, 8926, 8937, 8939	30/186-17	1446108M91	Filet 1/8" BSP - 1 fiche <i>Thread 1/8" BSP - 1 plug</i>	
Contacteurs de pression d'huile / Oil pressure switches				
240, 250, 265, 275, 290, 298, 550, 560, 565, 575, 590, 595, 675, 690, 698, 699, 1004	30/186-26	1677386M1	Circuit hydraulique <i>Hydraulic system</i>	
342, 350, 352, 355, 360, 362, 365, 372, 375, 382, 390, 396, 398, 399 Séries 4200, 4300, 5300 series	30/186-27	1693367M1	Circuit hydraulique <i>Hydraulic system</i>	
Séries 3000 autotronic series Séries 2600, 3600, 6100, 8100 series 2720, 2725, 3115, 3120, 3125, 8260	30/186-14	3381387M5	Circuit hydr. basse pression Sur couvercle de pompe Repère noir remplace repère rouge <i>Low pressure hyd. system On pump cover Black marking replace red one</i>	
Séries 6100, 8100 series 3635, 3645, 3655, 3670, 3690, 8260	30/186-13	3712668M3 3795286M11	3 bars circuit hydr. - Load sensing <i>3 bars hyd. system - Load sensing</i>	
Séries 3600, 6100, 8100, series 3115, 3120, 3125, 8260	30/186-18	3795628M12	Basse press. - circuit de transmission <i>Low pressure - Transmission</i>	
Séries 3600, 6100, 6200, 8100, series 3115, 3120, 3125	30/186-19	3582916M92	Sur couvercle latéral	
Sonde de température / Temperature sender unit				
Séries 100, 200, 300, 500, 600, 1000, 2200, 2600, 2700, 3000, 3100, 3600, 4200, 4300, 6100, 6200 series 8110, 8120, 8130, 8210, 8220  20D/F, 30E/H, 40E, 50E/EX/H/HX, 60H  24, 25, 240, 440, 530S, 560, 565, 660, 665	30/180-4	1877731M92	Filet 5/8" <i>Thread 5/8"</i>	

Les références des pièces sont indicatives.
Nos pièces ne sont pas d'origine

Part numbers are quoted for reference purposes only.
Our parts and accessories are not original.



CONTACTEURS SWITCHES

Tracteurs <i>Tractors</i>	Réf. Ref.	OEM	Description
Boîtes à fusible / fuses boxes			
154, 174, 184, 194, 234S	30/964-14	1424118M91	Pour 6 fusibles en céramique <i>For 6 ceramic fuses</i>
Séries 100, 200, 600 series 1004, 1014, 1024, 1114, 1134	30/964-15	3300568M91	Pour 10 fusibles en céramique <i>For 10 ceramic fuses</i>
Centrales clignotantes / blinking units			
133, 135/V, 148, 145V/S, 152F/V/S, 158F/V/S, 168F/S, 230, 235, 240, 245, 250, 255, 260, 265, 275, 290, 298 Séries 500, 2600, 2700, 3000, 3100, 3600, 6100, 6200, 8100, 8200 series  Séries 500, 800 series 660, 665	30/961-1	3617865M1	
254, 274, 1114, 1134	30/961-10	1808481M91	
Séries chenillards 200, 300 <i>crawlers series</i> 154, 174, 184, 194, 1014, 1024, 1114, 1134	30/961-11	3300536M92	
Capteurs inductifs / Inductive switches			
Séries 3000, 3600, 6100, 6200, 8100 series 3115, 3120, 3125	30/975-1	3583285M1	Vitesse PTO - Derniers montages <i>PTO speed - Later fitting</i> 
Séries 3000 series 3610, 3630, 3650, 3680	30/975-5	3386209M2	Vitesse PTO - Premiers montages <i>PTO speed - Early fitting</i> 
Séries 3000, 3600, 6100, 6200, 8100 series 3115, 3120, 3125	30/975-2	3583286M1	Vitesse tracteur <i>Tractor speed</i> 
Composants de relevage électroniques / Electronic lift parts			
Série 300 series 1007	30/976-1	3539477M1	Détecteur de position de relevage <i>Lift position detector</i> 
Séries 6100, 8100 series	30/976-2	3712728M3	Détecteur de position de relevage <i>Lift position detector</i> 
Série 300 series (Italy) 1007, 2210, 2220, 2230	30/976-3	3539071M92	Détecteur inférieur <i>Inferior detector</i>
Séries 3000, 3100, 3600 series	30/976-4	3383891M3	Boîtier électronique <i>Calculator</i>
Séries 6100, 8100 series	30/976-5	3715712M94	Boîtier électronique <i>Calculator</i>
Séries 3600, 4200, 6100, 6200, 8100, 8200 series, 3115, 3120, 3125	30/979-1	3580997M1	Potentiomètre de la console - Lg 25mm <i>Console potentiometer - Lg 25mm</i> 
Séries 3000, 3600 series 3115, 3120, 3125	30/979-2	3580998M1	Potentiomètre de la console - Lg. 36mm <i>Console potentiometer - Lg 36mm</i> 
	30/1881-6	3388348M93	Interrupteur de la console <i>Console switch</i> 











Les références des pièces sont indicatives.
Nos pièces ne sont pas d'origine

Part numbers are quoted for reference purposes only.
Our parts and accessories are not original.



**ECLAIRAGE
LIGHTING**

Optiques de phare / Front light lens

Réf. Ref.	OEM	Description	Fig.	Tracteurs Tractors
30/181-1 30/181-2	1672767M91 1672766M91	Conduite à gauche / <i>Left hand drive</i> Optique gauche / <i>LH headlamp</i> Optique droite / <i>RH headlamp</i>		Ø 126mm Glacé plate / <i>Flat glass</i> Séries 100, 200, 500, 600, 2600, 2700 series
30/181-3 30/181-4	1672769M91 1672768M91	Conduite à droite / <i>Right hand drive</i> Optique gauche / <i>LH headlamp</i> Optique droite / <i>RH headlamp</i>		375E, 390E, 1004, 1004T, 1080, 1200, 1250, 2805
63/1955-410	961866M1	Ampoule / <i>Bulb 12V/45-50W</i> (Asymétrique / <i>Asymmetrical</i>)		 20B, 20D, 40, B, 50BMKII, 50D
30/185-1	3405150M91	Socket / <i>Support</i>		
30/181-66 30/181-67	963717M1 963718M1	Conduite à droite / <i>Right hand drive</i> Optique gauche / <i>LH headlamp</i> Optique droite / <i>RH headlamp</i>		Ø 120mm Glacé galbée / <i>Round glass</i>
63/1955-410	961866M1	Ampoule / <i>Bulb 12V/45-50W</i> (Asymétrique / <i>Asymmetrical</i>)		Séries 100
30/185-1	3405150M91	Socket / <i>Support</i>		Rempl. / <i>Repl.</i> Auerroche, Hella, Butler, Lucas
30/181-46 30/181-49	3532565M91 3305625M91	Conduite à gauche / <i>Left hand drive</i> Optique / <i>Headlamp</i> Conduite à droite / <i>Right hand drive</i> Optique / <i>Headlamp</i>		Séries italiennes 100, 200, 300, 1000 <i>Italian series</i>
63/1955-410	961866M1	Ampoule / <i>Bulb 12V/45-50W</i> (Asymétrique / <i>Asymmetrical</i>)		
30/185-1	3405150M91	Socket / <i>Support</i>		
30/181-47 63/1955-410	1425874M91 961866M1	Optique / <i>Headlamp</i> Ampoule / <i>Bulb 12V/45-50W</i> (Asymétrique / <i>Asymmetrical</i>)		1114, 1134
30/185-1	3405150M91	Socket / <i>Support</i>		
30/181-41 63/1955-410	3301298M91 961866M1	Optique / <i>Headlamp</i> Ampoule / <i>Bulb 12V/45-50W</i> (Asymétrique / <i>Asymmetrical</i>)		134, 134C, 154, 154C, 174, 174C, 184, 194, 234S
30/185-1	3405150M91	Socket / <i>Support</i>		
30/181-44 63/1955-410	916234M91 961866M1	Optique / <i>Headlamp</i> Ampoule / <i>Bulb 12V/45-50W</i> (Asymétrique / <i>Asymmetrical</i>)		595, 595MKII (⇒ 150066) 2640, 2680 (⇒ 271212)
30/185-1	3405150M91	Socket / <i>Support</i>		 506, 507, 530, 530S, 535, 560, 565, 660, 665, 810, 815, 820, 825, 830, 835, 840, 845
30/181-7 30/181-8	1693943M93 1693944M93	Conduite à gauche / <i>Left hand drive</i> Optique / <i>Headlamp</i> Conduite à droite / <i>Right hand drive</i> Optique / <i>Headlamp</i>		Séries 300, 3000, 3100, 3600, series
63/1955-410	961866M1	Ampoule / <i>Bulb 12V/45-50W</i> (Asymétrique / <i>Asymmetrical</i>)		240, 253 (UK), 263 (UK) 4WD 6110, 6120, 6130, 6140 <i>Nezplongeant / Steep nose</i>
30/185-1	3405150M91	Socket / <i>Support</i>		9240
30/181-50 30/181-51 63/1955-410	3809345M91 3809346M91 961866M1	Conduite à gauche / <i>Left hand drive</i> Optique / <i>Headlamp</i> Conduite à droite / <i>Right hand drive</i> Optique / <i>Headlamp</i> Ampoule / <i>Bulb 12V/45-50W</i> (Asymétrique / <i>Asymmetrical</i>)		Séries 4200 series
30/185-1	3405150M91	Socket / <i>Support</i>		6235, 6245, 6255, 6260, 6265, 6270, 6280, 6290
				8210, 8220, 8240, 8250, 8260



Les références des pièces sont indicatives.
Nos pièces ne sont pas d'origine

Part numbers are quoted for reference purposes only.
Our parts and accessories are not original.



ECLAIRAGE LIGHTING

Optiques de phare / Front light lens

Réf. Ref.	OEM	Description	Fig.	Tracteurs Tractors
30/181-62 30/181-61 63/1955-472 30/185-1	3824711M92 3824712M91 3405186M1 3405150M91	Conduite à gauche / <i>Left hand drive</i> Optique / <i>Headlamp</i> Conduite à droite / <i>Right hand drive</i> Optique / <i>Headlamp</i> Ampoule / <i>Bulb H4 12V/55-60W</i> Sockt / <i>Support</i>		Séries 4200, 4300 series
30/181-42 63/1955-472 30/185-1	3713137M1 3713341M1 3405150M91	Optique sur toit de cabine <i>Headlamp on cab roof</i> Ampoule / <i>Bulb H4 12V/55-60W</i> Sockt / <i>Support</i>		Séries 4200, 4300, 6100, 6200, 8100, 8200 series
30/181-52 30/181-53 63/1955-410 30/185-1	3713798M91 3713799M91 961866M1 3405150M91	Conduite à gauche / <i>Left hand drive</i> Optique / <i>Headlamp</i> Conduite à droite / <i>Right hand drive</i> Optique / <i>Headlamp</i> Ampoule / <i>Bulb 12V/45-50W</i> (Asymétrique / <i>Asymmetrical</i>) Sockt / <i>Support</i>		Séries 6100, 8100 series 6260, 6270, 6280, 6290 Sans cabine / <i>Less cab</i> 8270, 8280

133, 135, 140, 145, 148, 152, 155, 158, 165,
168, 175, 178, 185, 188

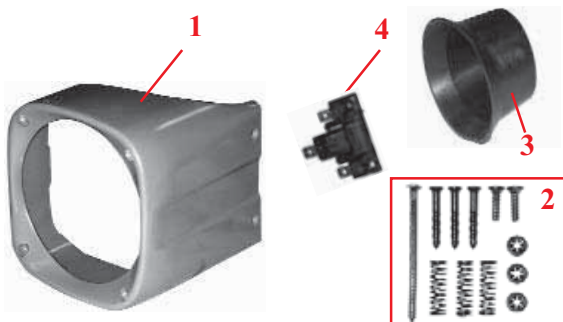

Réf. Ref.	OEM	Description	Fig.
30/182-1	1860184M1, 906071M1	Gauche / <i>LH</i>	1
30/182-2	1860183M1, 906070M1	Droit / <i>RH</i>	1
30/184-1	3405151M91		2
30/183-3	962842M2		3
30/185-1	3405150M91		4

Les références des pièces sont indicatives.
Nos pièces ne sont pas d'origine

ENSEMBLES COMPLETS / COMPLETE SETS

133, 135, 140, 145, 148, 152, 155, 158, 165,
168, 175, 178, 185, 188

Comprenant : Phares gauche et droit, Boitiers gauche et droit,
Jeux de fixation, adaptateurs, coiffes et ampoules
Content : *Headlamp LH and RH, Cowl LH and RH,*
Fixing kits, adapters, dust caps and bulbs











Réf. Ref.	Description
30/189-64	<i>Conduite à gauche / Left hand drive</i>
30/189-65	<i>Conduite à droite / Right hand drive</i>

Part numbers are quoted for reference purposes only.
Our parts and accessories are not original.



**ECLAIRAGE
LIGHTING**

Feux de position et clignotants / Front side lights & indicators

Réf. Ref.	OEM	Description	Fig.	Tracteurs Tractors
30/1918-111 30/1919-111 30/1919-112 63/1955-209		Feu / Lamp Cabochon blanc / White glass Cabochon rouge / Red glass Ampoule / Bulb 12V/5W		35, 135, 165, 178 Garde-boue ronds Round fenders
30/1918-113		Feu / Lamp		135, 230, 240 Garde-boue plats Flat fenders
30/1918-73 30/1918-74 30/1918-75 30/1919-74 63/1955-382 63/1955-245	1676287M91 1676286M91 1634224M1 1634225M1 621235M1 3002706X1	Feu gauche / Lamp LH Feu droit / Lamp RH Kit 2 feux / 2 lamp set Cabochon / Glass Ampoule / Bulb 12V/21W Ampoule / Bulb 12V/10W		133, 135, 140, 155, 158, 165, 168, 185, 188, 235, 245, 250, 254, 255, 260, 265, 274, 275, 285, 290, 298 Remplace montage ETMA Replace ETMA fitting
30/1918-59 30/1919-40 63/1955-382 63/1955-245	1424107M92 1424346M1 621235M1 3002706X1	Feu / Lamp Cabochon / Glass Ampoule / Bulb 12V/21W Ampoule / Bulb 12V/10W		154, 174, 184, 194, 234S, 254, 274,
30/1918-57 30/1918-56 30/1919-39 63/1955-382 63/1955-245	1678991M91 1678990M91 3310292M91 621235M1 3002706X1	Feu gauche / Lamp LH Feu droit / Lamp RH Cabochon / Glass Ampoule / Bulb 12V/21W Ampoule / Bulb 12V/10W		174F, 194F, 230, 235, 240, 245, 250, 253 (UK), 255, 265, 275, 275E, 290, 290E, 298, 374H, 375E, 390E, 394H
30/1918-69 30/1919-40 63/1955-382 63/1955-245	1678580M91 1424346M1 621235M1 3002706X1	Feu / Lamp Cabochon / Glass Ampoule / Bulb 12V/21W Ampoule / Bulb 12V/10W		230, 240, 250, 253 (UK), 265, 275, 290, 340, 560, 575, 590, 595
30/1918-63 30/1919-40 63/1955-382 63/1955-245	1695628M91 1424346M1 621235M1 3002706X1	Feu / Lamp Cabochon / Glass Ampoule / Bulb 12V/21W Ampoule / Bulb 12V/10W		350, 360, 362, 365, 375, 390, 398
30/1918-64 30/1919-38 63/1955-382 63/1955-239	619413M91 3383204M1 621235M1 621234M1	Feu / Lamp Cabochon / Glass Ampoule / Bulb 12V/21W Ampoule / Bulb 12V/5W		Séries 500, 2600, 2700 series 133, 135, 140, 145, 148, 152, 155, 158, 168, 240, 265, 275, 290 Séries 500, 600, 700, 800 series 186, 187, 206, 240, 307, 440, 487
30/1918-60 30/1918-61 30/1919-35 30/1919-36 63/1955-382 63/1955-245	1425883M93 1425884M93 1426603M1 1426605M1 621235M1 3002706X1	Feu gauche / Lamp LH Feu droit / Lamp RH Cabochon gauche / Glass LH Cabochon droit / Glass RH Ampoule / Bulb 12V/21W Ampoule / Bulb 12V/10W		Série 600 series 154, 174, 233, 253 (Italy), 254, 263T (Italy), 264T, 273, 274, 283, 284, 293, 294, 1004, 1004T, 1014, 1024, 1114, 1134

Les références des pièces sont indicatives.
Nos pièces ne sont pas d'origine

Part numbers are quoted for reference purposes only.
Our parts and accessories are not original.







"THE RELIABLE SERVICE"



ECLAIRAGE LIGHTING

Feux de position et clignotants / Front side lights & indicators

Réf. Ref.	OEM	Description	Fig.	Tracteurs Tractors
30/1918-68 30/1919-40 63/1955-382 63/1955-245	3387450M91 1424346M1 621235M1 3002706X1	Feu / Lamp Cabochon / Glass Ampoule / Bulb 12V/21W Ampoule / Bulb 12V/10W		Séries 3000, 3100, 3600 series 333, 353, 363, 373, 383, 393
30/1918-87 30/1919-40 63/1955-382 63/1955-245	3700535M91 1424346M1 621235M1 3002706X1	Feu / Lamp Cabochon / Glass Ampoule / Bulb 12V/21W Ampoule / Bulb 12V/10W		362, 365, 375, 390, 390T, 398, 399, Séries 4200, 4300 series Tracteurs avec marche-pied 2390mm Footstep tractors with 2390mm harness
30/1918-76 30/1918-77 30/1919-40 63/1955-382 63/1955-245	3809602M91 3809603M91 1424346M1 621235M1 3002706X1	Feu gauche / Lamp LH Feu droit / Lamp RH Cabochon / Glass Ampoule / Bulb 12V/21W Ampoule / Bulb 12V/10W		Séries 4200, 4300 series
30/1918-65 30/1919-65 30/1918-66 30/1919-66 63/1955-382 63/1955-245	3714185M91 3105506M1 3714184M92 3105505M1 621235M1 3002706X1	Feu sans clignotant Lamp without indicator Cabochon / Glass Feu avec clignotant Lamp with indicator Cabochon / Glass Ampoule / Bulb 12V/21W Ampoule / Bulb 12V/10W		Séries 6100, 6200, 8100, 8200 series

Feux combinés avant et arrière / Front and rear side combined lights & indicators

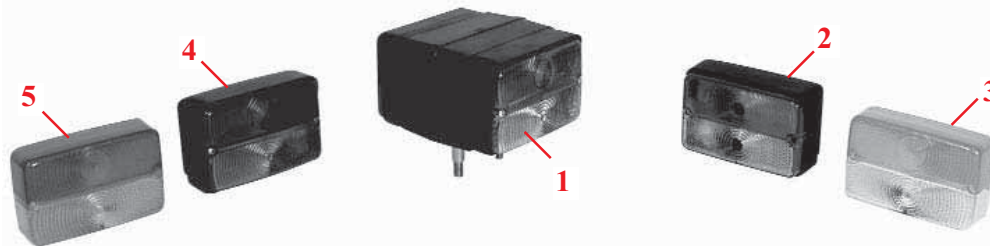

Réf. Ref.	OEM	Description	Fig.	Tracteurs Tractors
30/1918-88	3531529M91	Feu complet avant & arrière Complete front & rear light	1	Tracteurs italiens sans cabine séries 100, 300, 3200 Séries 100, 300, 3200 series Italian tractors less cab
30/1918-89 30/1919-40 63/1955-382 63/1955-245	3305584M92 1424346M1 621235M1 3002706X1	Feu avant / Front light Cabochon / Glass Ampoule / Bulb 12V/21W Ampoule / Bulb 12V/10W	2 3	Séries 100, 200 Tracteurs italiens sur roue Séries 100, 200 series Italian wheeled tractors Séries 200, 300 Tracteurs italiens sur chenille Séries 200, 300 series Italian crawler tractors
30/1912-145 30/1913-145 63/1955-382 63/1955-380	3309227M91 3310349M91 621235M1 908543M1	Feu arrière / Rear light Cabochon / Glass Ampoule / Bulb 12V/21W Ampoule / Bulb 12V/21-5W	4 5	Tracteurs italiens avec cabine séries 300, 3200 Séries 300, 3200 series Italian tractors with cab

Les références des pièces sont indicatives.
Nos pièces ne sont pas d'origine

Part numbers are quoted for reference purposes only.
Our parts and accessories are not original.



ECLAIRAGE LIGHTING

Feux arrière / Rear side lights & indicators

Réf. Ref.	OEM	Description	Fig.	Tracteurs Tractors
30/1912-132 30/1912-133 30/1912-140 30/1913-132	1633281M91 1633282M91	Feu gauche / Lamp LH Feu droit / Lamp RH Paire de feux / Pair Cabochon / Glass		133, 135, 140, 145, 152, 155, 158, 165, 168, 178, 185, 188, 235, 245, 250, 254, 255, 260, 265, 274, 275, 285, 290, 298, 560, 575, 590
63/1955-382 63/1955-380	621235M1 908543M1	Ampoule / Bulb 12V/21W Ampoule / Bulb 12V 21/5W		Remplace montage ETMA Replace ETMA fitting
30/1912-116 30/1912-117 30/1913-111 30/1913-110	1871758M91 1871759M91 1630968M1 1630967M1	Feu gauche / Lamp LH Feu droit / Lamp RH Cabochon gauche / Glass LH Cabochon droit / Glass RH		133, 135, 140, 145, 148, 152, 155, 158, 168, 240
63/1955-382 63/1955-239	621235M1 621234M1	Ampoule / Bulb 12V/21W (x2) Ampoule / Bulb 12V/5W		
30/1912-112 30/1912-113	1424105M92 1424106M92	Feu gauche / Lamp LH Feu droit / Lamp RH		154, 174, 184, 194, 234S, 254, 274
30/1913-118	1424354M1	Cabochon / Glass		
63/1955-382 63/1955-245	621235M1 3002706X1	Ampoule / Bulb 12V/21W (x2) Ampoule / Bulb 12V/10W		
30/1912-14 30/1912-15 30/1913-12 30/1913-13	1425885M92 1425886M92 1426607M1 1426609M1	Feu gauche / Lamp LH Feu droit / Lamp RH Cabochon gauche / Glass LH Cabochon droit / Glass RH		154, 174, 233, 253, 254, 263, 264, 273, 274, 283, 284, 293, 294, 675, 690, 698, 699, 1004, 1014, 1024, 1114, 1134
63/1955-382 63/1955-239	621235M1 621234M1	Ampoule / Bulb 12V/21W (x2) Ampoule / Bulb 12V/5W		
30/1912-10 30/1912-11 30/1913-112	1678868M92 1678869M92 3310307M91	Feu gauche / Lamp LH Feu droit / Lamp RH Cabochon / Glass		174F, 194F, 230, 235, 240, 245, 250, 253 (UK), 255, 265, 275, 275E, 290, 290E, 298, 340, 374H, 375, 375E, 390E, 394H, 550, 565, 575, 590
63/1955-382 63/1955-380	621235M1 908543M1	Ampoule / Bulb 12V/21W Ampoule / Bulb 12V 21/5W		
30/1912-121	1682738M91	Feu / Lamp		230, 240, 250, 253, 263
63/1955-382 63/1955-380	621235M1 908543M1	Ampoule / Bulb 12V/21W Ampoule / Bulb 12V 21/5W		
30/1912-122 30/1913-113	1695847M92 3311571M91	Feu / Lamp Cabochon / Glass		350, 355, 360, 362, 365, 375, 390, 398, 399
63/1955-382 63/1955-380	621235M1 908543M1	Ampoule / Bulb 12V/21W Ampoule / Bulb 12V 21/5W		
30/1912-146 30/1913-113	3536200M91 3311571M91	Feu / Lamp Cabochon / Glass		333, 350, 353, 355, 360, 363, 365, 373, 377, 383, 387, 390T, 393, 397, 397T, 398, 399, 1007
63/1955-382 63/1955-380	621235M1 908543M1	Ampoule / Bulb 12V/21W Ampoule / Bulb 12V 21/5W		
30/1912-147 30/1913-112	3763386M92 3763387M92 3310307M91	Feu / Lamp Cabochon / Glass		362, 362N, 365, 372N, 375, 382N, 390, 390T, 398, 399
63/1955-382 63/1955-380	621235M1 908543M1	Ampoule / Bulb 12V/21W Ampoule / Bulb 12V 21/5W		







Les références des pièces sont indicatives.
Nos pièces ne sont pas d'origine

Part numbers are quoted for reference purposes only.
Our parts and accessories are not original.



**ECLAIRAGE
LIGHTING**

Feux arrière / Rear side lights & indicators

Réf. Ref.	OEM	Description	Fig.	Tracteurs Tractors
30/1912-120	3476047M91	Feu / Lamp		350, 355, 360, 365, 375, 390, 398, 399
30/1913-112	3310307M91	Cabochon / Glass		
63/1955-382 63/1955-380	621235M1 908543M1	Ampoule / Bulb 12V/21W Ampoule / Bulb 12V 21/5W		
30/1912-118 30/1912-119 30/1913-112	1680334M91 1680335M91 3310307M91	Feu gauche / Lamp LH Feu droit / Lamp RH Cabochon / Glass		550, 565, 575, 590
63/1955-382 63/1955-380	621235M1 908543M1	Ampoule / Bulb 12V/21W Ampoule / Bulb 12V 21/5W		
30/1912-152 30/1912-153 30/1913-152 30/1913-153	3042085M2 3042086M2 3100765M1 3100766M1	Feu gauche / Lamp LH Feu droit / Lamp RH Cabochon gauche / Glass LH Cabochon droit / Glass RH		
63/1955-382 63/1955-380	621235M1 908543M1	Ampoule / Bulb 12V/21W Ampoule / Bulb 12V 21/5W		2620, 2625, 2640, 2645, 2680, 2685, 2720, 2725 7242, 7254, 7256, 7272, 7274, 7278
30/1912-123 30/1913-114	3389964M91 3105050M1	Feu / Lamp Cabochon / Glass		
63/1955-382 63/1955-380	621235M1 908543M1	Ampoule / Bulb 12V/21W Ampoule / Bulb 12V 21/5W		
30/1912-148 30/1913-113	3699490M92 3311571M91	Feu / Lamp Cabochon / Glass		Séries 3000, 3100, 3600 series 333, 353, 363, 373, 383, 393
63/1955-382 63/1955-380	621235M1 908543M1	Ampoule / Bulb 12V/21W Ampoule / Bulb 12V 21/5W		
30/1912-149 30/1913-113	3699491M92 3311571M91	Feu / Lamp Cabochon / Glass		
63/1955-382 63/1955-380	621235M1 908543M1	Ampoule / Bulb 12V/21W Ampoule / Bulb 12V 21/5W		Séries 4200, 4300 series 362, 362N, 365, 375, 382N, 390, 390T, 396, 398, 399
30/1912-136 30/1912-137 30/1913-113	3809632M91 3808994M91 3311571M91	Feu gauche / Lamp LH Feu droit / Lamp RH Cabochon / Glass		
63/1955-382 63/1955-380	621235M1 908543M1	Ampoule / Bulb 12V/21W Ampoule / Bulb 12V 21/5W		
30/1912-138 30/1913-114	3713911M92 3105050M1	Feu / Lamp Cabochon / Glass		Séries 4200, 4300 series 362, 365, 375, 390, 390T, 396, 398, 399
63/1955-382 63/1955-380	621235M1 908543M1	Ampoule / Bulb 12V/21W Ampoule / Bulb 12V 21/5W		
30/1912-150 30/1912-151	3781445M92 3781444M92	Feu gauche / Lamp LH Feu droit / Lamp RH		
63/1955-382 63/1955-245	621235M1 3002706X1	Ampoule / Bulb 12V/21W x2 Ampoule / Bulb 12V/15W		Séries 6100, 6200, 8100, series 8210, 8220
63/1920-7	1684272M1, 3619018M91, 3713952M91, 3810085M91, 960852M91	Eclaire-plaque Number plate lamp		
63/1920-8	3042143M91, 3809543M91, 829121M1	Eclaire-plaque Number plate lamp		

Les références des pièces sont indicatives.
Nos pièces ne sont pas d'origine

Part numbers are quoted for reference purposes only.
Our parts and accessories are not original.



ECLAIRAGE LIGHTING

Phares de travail / Worklamp

Tracteurs Tractors	Avant / Front		Arrière / Rear	
	OEM	Réf. / Ref.	OEM	Réf. / Ref.
342, 350, 352, 355, 360, 362, 362N, 365, 375, 382N, 390, 390T, 396, 398, 399	3611781M91	30/1931-13		
Séries 4200, 4300, 6100, 6200, 8100, 8200 <i>series</i>	3713134M91	30/1931-14	3713130M91	30/1931-16



154, 174, 184, 194, 234S, 254, 274, 1104

Arrière / Rear



63/1931-33
(1423870M92)

Ampoule / Bulb :
63/1955-453 (12V/55W)
(1628494M1)

Séries 100, 200, 500 *series*
340, 375E, 390E, 1200, 1250,
2675, 2705, 2745, 2775, 2805
Moiss-Bat 520, 525, 620, 625 *Combines*

Arrière / Rear



30/1931-17
(1886656M91, 886997M91,
1678582M92)

Optique / Lens :
30/1932-17
Ampoule / Bulb :
63/1955-453 (12V/55W) (1628494M1)

63/1931-28



Ampoules incluses
Bulbs included :
63/1955-453 (12V/55W) x2
(1628494M1)

63/1931-29



Ampoules incluses
Bulbs included :
63/1955-453 (12V/55W) x2
(1628494M1)

Gyrophare / Beacon

Support escamotable / Retractable support

6465, 6475, 6480, 6485, 6490, 6495, 7465, 7475, 7480



63/1943-16
(4271246M91)

Gyrophare / Beacon



63/1940-19







Pour d'autres phares voir aussi notre catalogue au fascicule 1
For other lamps see electrical catalogue

Les références des pièces sont indicatives.
Nos pièces ne sont pas d'origine

Part numbers are quoted for reference purposes only.
Our parts and accessories are not original.



**CABLES D'EMBRAYAGES
CLUTCH CABLES**

Tracteurs Tractors	Réf. Ref.	OEM	Longueur A Length A
			
274SK, 284S, 294S, 377, 387, 397, 397T, 1007 (Embrayage PDF à main / Hand cable - Lower clutch PTO)	30/198-8	1427397M93	850 mm
			
274SK, 284S, 294S, 377, 387, 397, 397T, 1007 (Embrayage au pied / Foot cable)	30/198-9	1427398M93	740 mm
1014, 1024 (Embrayage au pied / Foot cable)	30/198-10	3301290M93	805 mm
			
342, 352, 362N, 372N, 382N 365, 375, 390, 390T, 398 (B18009 ⇒) <i>Avec cabine LoProfile / With LoProfile cab</i>	30/198-13	3700937M92	692mm
362, 362N, 372N, 382N, 396 365, 375, 390, 390T, 398 (B18009 ⇒) <i>Avec cabine LoProfile / With LoProfile cab</i>	30/198-12	3699304M92	731mm
362, 362N, 382N, 396, 399 (1006.6) 365, 375, 390, 390T, 398 (B18009 ⇒) <i>Avec cabines HiLine, Versacab, Duncan / With HiLine, Versacab, Duncan cabs</i>	30/198-11	3699303M92	822mm
			
4215, 4220, 4225, 4235, 4240, 4315, 4320, 4325, 4335 <i>Avec cabine LoProfile / With LoProfile cab</i>	30/198-17	3813544M92	691mm
4225, 4235, 4240, 4245, 4255, 4265, 4325, 4335, 4345, 4355 <i>Avec cabine LoProfile / With LoProfile cab</i>	30/198-16	3813543M92	721mm
4225, 4235, 4240, 4245, 4255, 4265, 4325, 4335, 4345, 4355, 4365 <i>Avec cabines HiLine & Versacab / With HiLine & Versacab cabs</i>	30/198-15	3813542M92	816mm
4225, 4235, 4240, 4245, 4255, 4260, 4265, 4270, 4325, 4335, 4345, 4355, 4360, 4365, 4370 <i>Avec cabines HiLine & Versacab / With HiLine & Versacab cabs</i>	30/198-14	3813541M92	871mm

**CONVERTISSEUR DE COUPLE
TORQUE CONVERTER**

 40, 50, 50B, 50B MKII, 50D

30/199-3
(2757279M91)



Les références des pièces sont indicatives.
Nos pièces ne sont pas d'origine

Part numbers are quoted for reference purposes only.
Our parts and accessories are not original.



MECANISMES & DISQUES D'EMBRAYAGE
CLUTCH ASSEMBLIES & PLATES

Légendes voir page 232 - Figures voir pages 233-236 - Key See page 232 - Figures see pages 233-236

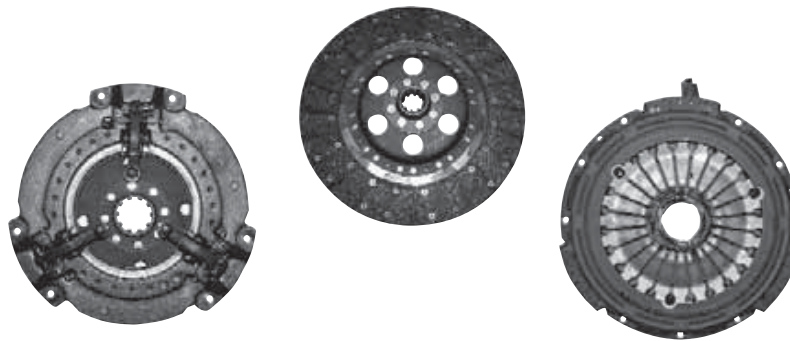

Tracteurs Tractors	Embrayage Clutch		Disque Plate		Butée de débrayage Release bearing
	Ø	N°	Ø	N°	
TE20 (Petrol)	9" 230	Sur demande Reconditionné <i>On request - rebuild unit</i>	9"	30/221-226 UF 10Z 29x35 (8572)	30/231-23 52x84x20 (4069)
TEF20 (Diesel)	10" 250	Sur demande Reconditionné <i>On request - rebuild unit</i>	10"	30/221-227 UF 10Z 29x35 (8778)	30/230-1 AV (828123M2)
FE35 (Moteur 23C Engine)	10"	Sur demande Reconditionné <i>On request - rebuild unit</i>	10" LN	30/221-91 TF 10Z 23x29 (1851668M1)	
	9"/11" 230/280 GA3	30/200-251 (894131M92)	9" LK 11" LN	30/212-1 UF 10Z 39x45 (3620411M91) 30/221-93 UF 10Z 23x29 (899971M92)	
35, 835	9"/11" GA3	30/200-1 (3620401M91)	9" LK	30/212-1 UF 10Z 39x45 (3620411M91)	30/231-1 64x103x23 (892862M3) 30/231-16 (Economy)
		30/200-1KT	11" LN	30/221-1 UF 10Z 23x29 (3620410M92)	
	9"/11" GA3 LUK	30/200-1L 228005741	11" LN	30/221-1L UF 10Z 23x29 327000246	30/230-1 AV (828123M2)
25, 30, 130, 825	9"/11" 230/280 GA3		9" LK	30/212-56 UF 19Z 29x32 (967725M1)	
			11" LN	30/221-94 UF 11Z 15.5x19 (963839M1)	
65, 765, 865	9"/11"	30/200-2 (3620402M91)	9" LK	30/212-1 UF 10Z 39x45 (3620411M91)	
			11" LN	30/221-1 UF 10Z 23x29 (3620410M92)	
			11" LN	30/221-1L 327000246	

Les références des pièces sont indicatives.
Nos pièces ne sont pas d'origine

Part numbers are quoted for reference purposes only.
Our parts and accessories are not original.



MECANISMES & DISQUES D'EMBRAYAGE CLUTCH ASSEMBLIES & PLATES

Légendes voir page 232 - Figures voir pages 233-236 - Key See page 232 - Figures see pages 233-236

Tracteurs Tractors	Embrayage Clutch		Disque Plate		Butée de débrayage Release bearing
	Ø	N°	Ø	N°	
133, 135, 140	9"/11" 230/280 GA3	30/200-1 (3620401M91)	9" LK	30/212-1 UF 10Z 39x45 (3620411M91)	
		30/200-1KT	11" LN	30/221-1 UF 10Z 23x29 (3620410M92)	
	9"/11" GA3	30/200-1L 228005741	11" LN	30/221-1L UF 10Z 23x29 327000246	
			11" LN	30/221-61 VC 10Z 23x29 (185892M94)	
	10"/12" 250/300 GA3	30/200-4 (3620407M91)	10" LK	30/212-4 UF 10Z 39x45 (3620409M91)	
10"/12" 250/300 GA3	30/200-7 (3599463M92)	12" LN	30/221-3 UF 10Z 23x29 (3599462M92)		
		12" LN	30/221-62 UC 10Z 23x29 (887890M93)		
		10" LK	30/212-6 UF 25Z 38x41 (3478359M91)		
12" NV-G3 25Z	30/200-61 (3599491M92)	12" LN	30/221-3 UF 10Z 23x29 (3599462M92)		
		12" LN	30/221-62 UC 10Z 23x29 (887890M93)		
		12" LN	30/221-3 UF 10Z 23x29 (3599462M92)		
145	9"/11" GA3	30/200-1 (3620401M91)	9" LK	30/212-1 UF 10Z 39x45 (3620411M91)	
		30/200-1KT	11" LN	30/221-1 UF 10Z 23x29 (3620410M92)	
	9"/11" GA3 LUK	30/200-1L 228005741	11" LN	30/221-1L UF 10Z 23x29 327000246	

Les références des pièces sont indicatives.
Nos pièces ne sont pas d'origine

Part numbers are quoted for reference purposes only.
Our parts and accessories are not original.



MECANISMES & DISQUES D'EMBRAYAGE CLUTCH ASSEMBLIES & PLATES

Légendes voir page 232 - Figures voir pages 233-236 - Key See page 232 - Figures see pages 233-236

Tracteurs Tractors	Embrayage Clutch		Disque Plate		Butée de débrayage Release bearing	
	Ø	N°	Ø	N°		
148, 152	10"/12" 250/300 GA3	30/200-4 (3620407M91)	10" LK	30/212-4 UF 10Z 39x45 (3620409M91)		
			12" LN	30/221-3 UF 10Z 23x29 (3599462M92)		
			12" LN	30/221-62 UC 10Z 23x29 (887890M93)		
	10"/12" 250/300 GA3	30/200-7 (3599463M92)	10" LK	30/212-6 UF 25Z 38x41 (3478359M91)		
			12" LN	30/221-3 UF 10Z 23x29 (3599462M92)		
			12" LN	30/221-62 UC 10Z 23x29 (887890M93)		
	12" NV-G3 25Z	30/200-61 (3599491M92)	12" LN	30/221-3 UF 10Z 23x29 (3599462M92)		30/231-1 64x103x23 (892862M3)
			12" LN	30/221-62 UC 10Z 23x29 (887890M93)		30/231-16 (Economy)
	155, 158	10"/12" 250/300 GA3	30/200-4 (3620407M91)	10" LK		30/212-4 UF 10Z 39x45 (3620409M91)
12" LN				30/221-3 UF 10Z 23x29 (3599462M92)		
12" LN				30/221-62 UC 10Z 23x29 (887890M93)		
10"/12" 250/300 GA3		30/200-8 (3599464M92)	10" LK	30/212-6 UF 25Z 38x41 (3478359M91)		
			12" LN	30/221-3 UF 10Z 23x29 (3599462M92)		
			12" LN	30/221-62 UC 10Z 23x29 (887890M93)		
12" NV-G3 25Z		30/200-61 (3599491M92)	12" LN	30/221-3 UF 10Z 23x29 (3599462M91)		
			12" LN	30/221-62 UC 10Z 23x29 (887890M93)		

Les références des pièces sont indicatives.
Nos pièces ne sont pas d'origine

Part numbers are quoted for reference purposes only.
Our parts and accessories are not original.

MF-220



"THE RELIABLE SERVICE"



Ed.1 (07/04)

MECANISMES & DISQUES D'EMBRAYAGE CLUTCH ASSEMBLIES & PLATES

Légendes voir page 232 - Figures voir pages 233-236 - Key See page 232 - Figures see pages 233-236

Tracteurs Tractors	Embrayage Clutch		Disque Plate		Butée de débrayage Release bearing
	Ø	N°	Ø	N°	
165, 168	9"/11"	30/200-2 (3620402M91)	9" LK	30/212-1 UF 10Z 39x45 (3620411M91)	30/231-1 64x103x23 (892862M3) 30/231-16 (Economy) 30/230-1 AV (828123M2)
			11" LN	30/221-1 UF 10Z 23x29 (3620410M92)	
			11" LN	30/221-1L UF 10Z 23x29 327000246	
	10"/12" 250/300 GA3	30/200-6 (3620408M91)	10" LK	30/212-4 UF 10Z 39x45 (3620409M91)	
12" LN			30/221-3 UF 10Z 23x29 (3599462M92)		
12" LN			30/221-62 UC 10Z 23x29 (887890M93)		
10"/12" 250/300 GA3	30/200-8 (3599464M92)	10" LK	30/212-6 UF 25Z 38x41 (3478359M91)		
		12" LN	30/221-3 UF 10Z 23x29 (3599462M92)		
		12" LN	30/221-62 UC 10Z 23x29 (887890M93)		
12" NV-G3 25Z	30/200-62 (3599494M92) 30/200-62KT	12" LN	30/221-3 UF 10Z 23x29 (3599462M92)		
		12" LN	30/221-62 UC 10Z 23x29 (887890M93)		
175, 178	9"/11" 250/280 GA3	30/200-3 (3620403M91)	9" LK	30/212-1 UF 10Z 39x45 (3620411M91)	
			11" LN	30/221-1 UF 10Z 23x29 (3620410M92)	
			11" LN	30/221-1L UF 10Z 23x29 327000246	
178	10"/12" 250/300 GA3	30/200-6 (3620408M91)	10" LK	30/212-4 UF 10Z 39x45 (3620409M91)	
			12" LN	30/221-3 UF 10Z 23x29 (3599462M92)	
			12" LN	30/221-62 UC 10Z 23x29 (887890M93)	

...⇒ Voir page suivante / See next page

Les références des pièces sont indicatives.
Nos pièces ne sont pas d'origine

Part numbers are quoted for reference purposes only.
Our parts and accessories are not original.



MECANISMES & DISQUES D'EMBRAYAGE CLUTCH ASSEMBLIES & PLATES

Légendes voir page 232 - Figures voir pages 233-236 - Key See page 232 - Figures see pages 233-236

Tracteurs Tractors	Embrayage Clutch		Disque Plate		Butée de débrayage Release bearing
	Ø	N°	Ø	N°	
⇒... Voir page précédente / See previous page 178	12" NV-G3 10Z	30/200-66 (3620406M91)	12" LN 12" LN	30/221-3 UF 10Z 23x29 (3599462M92) 30/221-62 UC 10Z 23x29 (887890M93)	
185, 188	10"/12" 250/300 GA3	30/200-6 (3620408M91)	10" LK	30/212-4 UF 10Z 39x45 (3620409M91)	30/231-1 64x103x23 (892862M3) 30/231-16 (Economy) 30/230-1 AV (828123M2)
			12" LN	30/221-3 UF 10Z 23x29 (3599462M92)	
			12" LN	30/221-62 UC 10Z 23x29 (887890M93)	
	10"/12"	30/200-9 (3610268M92)	10" LK	30/212-6 UF 25Z 38x41 (3478359M91)	
	12" NV-G3 10Z	30/200-66 (3620406M91)	12" LN	30/221-3 UF 10Z 23x29 (3599462M92)	
230, 240, 250	10"/12" 250/300 GA3	30/200-7 (3599463M92)	12" LN	30/221-62 UC 10Z 23x29 (887890M93)	
			12" LN	30/221-3 UF 10Z 23x29 (3599462M92)	
			10"/12"	30/200-61 (3599491M92)	12" LN
	12" NV-G3 25Z	30/200-63 (3599496M93) 30/200-3KT	12" LN	30/221-3 UF 10Z 23x29 (3599462M92)	
			12" LN	30/221-62 UC 10Z 23x29 (887890M93)	

Les références des pièces sont indicatives.
Nos pièces ne sont pas d'origine

Part numbers are quoted for reference purposes only.
Our parts and accessories are not original.

MF-222



"THE RELIABLE SERVICE"



Ed.1 (07/04)

MECANISMES & DISQUES D'EMBRAYAGE CLUTCH ASSEMBLIES & PLATES

Légendes voir page 232 - Figures voir pages 233-236 - Key See page 232 - Figures see pages 233-236

Tracteurs Tractors	Embrayage Clutch		Disque Plate		Butée de débrayage Release bearing
	Ø	N°	Ø	N°	
235, 245, 255	10"/12" 250/300 GA3	30/200-7 (3599463M92)	10" LK	30/212-6 UF 25Z 38x41 (3478359M91)	
			12" LN	30/221-3 UF 10Z 23x29 (3599462M92)	
			12" LN	30/221-62 UC 10Z 23x29 (887890M93)	
260, 265, 275	10"/12" 250/300 GA3	30/200-8 (3599464M92)	10" LK	30/212-6 UF 25Z 38x41 (3478359M91)	
			12" LN	30/221-3 UF 10Z 23x29 (3599462M92)	
			12" LN	30/221-62 UC 10Z 23x29 (887890M93)	
	12" NV-G3 25Z	30/200-62 (3599494M92) 30/200-62KT	12" LN	30/221-3 UF 10Z 23x29 (3599462M92)	30/231-1 64x103x23 (892862M3)
			12" LN	30/221-62 UC 10Z 23x29 (887890M93)	
275, 290	10"/12" 250/300 GA3	30/200-272 (3701003M91)	10" LK	30/212-6 UF 25Z 38x41 (3478359M91)	30/231-16 (Economy) 30/230-1 AV (828123M2)
			12" LN	30/221-68 UC 21Z 25.4x29.5 (3701008M91)	
			12" LN	30/221-71 TC 21Z 25.4x29.5 (3701009M91)	
285 (A4.248) 290	10"/12" 250/300 GA3	30/200-9 (3610268M92)	10" LK	30/212-6 UF 25Z 38x41 (3478359M91)	
			12" LN	30/221-3 UF 10Z 23x29 (3599462M92)	
			12" LN	30/221-62 UC 10Z 23x29 (887890M93)	
	12" NV-G3 25Z	30/200-63 (3599496M93) 30/200-63KT	12" LN	30/221-3 UF 10Z 23x29 (3599462M92)	
12" LN			30/221-62 UC 10Z 23x29 (887890M93)		

Les références des pièces sont indicatives.
Nos pièces ne sont pas d'origine

Part numbers are quoted for reference purposes only.
Our parts and accessories are not original.



MECANISMES & DISQUES D'EMBRAYAGE CLUTCH ASSEMBLIES & PLATES

Légendes voir page 232 - Figures voir pages 233-236 - Key See page 232 - Figures see pages 233-236

Tracteurs Tractors	Embrayage Clutch		Disque Plate		Butée de débrayage Release bearing
	Ø	N°	Ø	N°	
285 (A4.318)	12" NV-G3 25Z	30/200-67 (1808749M94)	12" LN 12" LN	30/221-63 UF 10Z 23x29 (3620400M92) 30/221-64 UC 10Z 23x29 (1670234M91)	
298	13" NO-G3 25Z	30/200-68 (3620413M91)	13" 13"	30/221-65 UF 10Z 23x29 (3610281M92) 30/221-66 UC 10Z 23x29 (1688187M91)	
154, 174, 184, 194, 233, 234, 253, 254, 263, 264, 273, 274, 283, 284, 293, 294 333, 334V, 353, 354, 363, 364, 367, 373, 374, 376C, 377, 383, 384, 393, 394, 396	280/280 LUK GU6	30/200-403L (3600243M91)	280 LG 280 LG 280 LM 280 LM	30/221-411 TF 14Z 35x40 (3311538M92) 30/221-411L 328001016 30/212-55 UF 10Z 22x25 (1424135M93) 30/212-55L 328008316	30/231-61 MS 50x94x21 (1423473M94)
	280/280 LUK GU6	30/200-402L (3600242M91)	280 LG 280 LG 280 LG 280 LM 280 LM 280 LM	30/221-412 TC 14Z 35x40 (3311326M93) 30/221-412L 238001014 30/221-412E (Econ.) UC 14Z 35x40 30/212-55L UF 10Z 22x25 (1424135M91) 30/212-55 UF 10Z 22x25 30/212-55E (Econ.) UF 10Z 22x25	30/231-68 MT 65x100x11 (1442381X1) 30/230-24 AV (339599X1)
	310/310 LUK GU6	30/200-254L (3540478M91)	310 LG 310 LM	30/221-95L TC 14Z 35x40 (3311380M93) 30/212-58L UF 10Z 22x25 (3105233M92)	

Les références des pièces sont indicatives.
Nos pièces ne sont pas d'origine

Part numbers are quoted for reference purposes only.
Our parts and accessories are not original.

MF-224



"THE RELIABLE SERVICE"



Ed.1 (07/04)

MECANISMES & DISQUES D'EMBRAYAGE CLUTCH ASSEMBLIES & PLATES

Légendes voir page 232 - Figures voir pages 233-236 - Key See page 232 - Figures see pages 233-236

Tracteurs Tractors	Embrayage Clutch		Disque Plate		Butée de débrayage Release bearing
	Ø	N°	Ø	N°	
340	10"/12" 250/300 GA3	30/200-7 (3599463M92)	10" LK	30/212-6 UF 25Z 38x41 (3478359M91)	30/231-1 64x103x23 (892862M3)
			12" LN	30/221-3 UF 10Z 23x29 (3599462M92)	
12" LN	30/221-62 UC 10Z 23x29 (887890M93)	30/231-16 (Economy)			
12" LN	30/221-3 UF 10Z 23x29 (3599462M92)				
342, 350	10"/12" 250/300 GA3	30/200-7 (3599463M92)	12" LN	30/221-3 UF 10Z 23x29 (3599462M92)	30/231-70 CD (3700527M1)
			12" LN	30/221-62 UC 10Z 23x29 (887890M93)	
342, 350	10"/12" 250/300 GA3	30/200-7 (3599463M92)	10" LK	30/212-6 UF 25Z 38x41 (3478359M91)	30/230-1 AV (828123M2)
			12" LN	30/221-38 UF 21Z 25.4x29.5 (3610274M92)	
			12" LN	30/221-36 TF 21Z 25.4x29.5 (3599460M92)	
			12" LN	30/221-37 UC 21Z 25.4x29.5 (1693883M91)	
342, 350	12" NV-G3 25Z	30/200-61 (3599491M92)	12" LN	30/221-38 UF 21Z 25.4x29.5 (3610274M92)	30/231-1 64x103x23 (892862M3)
			12" LN	30/221-36 TF 21Z 25.4x29.5 (3599460M92)	
			12" LN	30/221-37 UC 21Z 25.4x29.5 (1693883M91)	
352, 355, 360, 362, 365	10"/12" 250/300 GA3	30/200-8 (3599464M92)	10" LK	30/212-6 UF 25Z 38x41 (3478359M91)	30/231-16 (Economy)
			12" LN	30/221-38 UF 21Z 25.4x29.5 (3610274M92)	
			12" LN	30/221-36 TF 21Z 25.4x29.5 (3599460M92)	
			12" LN	30/221-37 UC 21Z 25.4x29.5 (1693883M91)	

Les références des pièces sont indicatives.
Nos pièces ne sont pas d'origine

Part numbers are quoted for reference purposes only.
Our parts and accessories are not original.



MECANISMES & DISQUES D'EMBRAYAGE CLUTCH ASSEMBLIES & PLATES

Légendes voir page 232 - Figures voir pages 233-236 - Key See page 232 - Figures see pages 233-236

Tracteurs Tractors	Embrayage Clutch		Disque Plate		Butée de débrayage Release bearing
	Ø	N°	Ø	N°	
352, 355, 360, 362, 365	12" NV-G3 25Z	30/200-62 (3599494M92) 30/200-64KT	12" LN 12" LN 12" LN	30/221-38 UF 21Z 25.4x29.5 (3610274M92) 30/221-36 TF 21Z 25.4x29.5 (3599460M92) 30/221-37 UC 21Z 25.4x29.5 (1693883M91)	
375	10"/12" 250/300 GA3	30/200-8 (3599464M92)	10" LK	30/212-6 UF 25Z 38x41 (3478359M91)	30/231-1 64x103x23 (892862M3) 30/231-16 (Economy) 30/231-70 CD (3700527M1)
			12" LN	30/221-38 UF 21Z 25.4x29.5 (3610274M92)	
12" LN	30/221-36 TF 21Z 25.4x29.5 (3599460M92)				
12" LN	30/221-37 UC 21Z 25.4x29.5 (1693883M91)				
375	12" NV-G3 25Z	30/200-62 (3599494M92) 30/200-64KT	12" LN	30/221-38 UF 21Z 25.4x29.5 (3610274M92)	30/230-1 AV (828123M2)
			12" LN	30/221-36 TF 21Z 25.4x29.5 (3599460M92)	
			12" LN	30/221-37 UC 21Z 25.4x29.5 (1693883M91)	
375	12" NV-G3 25Z	30/200-71 (3697161M91)	12" LN	30/221-68 UC 21Z 25.4x29.5 (3701008M91)	
390	10"/12" 250/300 GA3	30/200-9 (3610268M92)	12" LN	30/221-71 TC 21Z 25.4x29.5 (3701009M91)	
			10" LK	30/212-6 UF 25Z 38x41 (3478359M91)	
			12" LN	30/221-38 UF 21Z 25.4x29.5 (3610274M92)	
			12" LN	30/221-36 TF 21Z 25.4x29.5 (3599460M92)	
			12" LN	30/221-37 UC 21Z 25.4x29.5 (1693883M91)	

...⇒ Voir page suivante / See next page

Les références des pièces sont indicatives.
Nos pièces ne sont pas d'origine



"THE RELIABLE SERVICE"



Part numbers are quoted for reference purposes only.
Our parts and accessories are not original.

MF-226

Ed.1 (07/04)

MECANISMES & DISQUES D'EMBRAYAGE CLUTCH ASSEMBLIES & PLATES

Légendes voir page 232 - Figures voir pages 233-236 - Key See page 232 - Figures see pages 233-236

Tracteurs Tractors	Embrayage Clutch		Disque Plate		Butée de débrayage Release bearing
	Ø	N°	Ø	N°	
⇒... Voir page précédente / See previous page 390	12" NV-G3 25Z	30/200-61 (3599491M92)	12" LN	30/221-38 UF 21Z 25.4x29.5 (3610274M92)	
			12" LN	30/221-36 TF 21Z 25.4x29.5 (3599460M92)	
			12" LN	30/221-37 UC 21Z 25.4x29.5 (1693883M91)	
	12" NV-G3 25Z	30/200-71 (3697161M91)	12" LN	30/221-68 UC 21Z 25.4x29.5 (3701008M91)	
			12" LN	30/221-71 TC 21Z 25.4x29.5 (3701009M91)	
398 (⇒ 15227)	13" NV-G3 25Z	30/200-69 (3620414M91)	13"	30/221-65 UF 10Z 23x29 (3610281M92)	
			13"	30/221-66 UC 10Z 23x29 (1688187M91)	
390T, 396, 398 (15228 ⇒) 399	13" NV-G3 25Z	30/200-70 (3599492M91)	13"	30/221-69 TF 21Z 25.4x29.5 (3599461M92)	30/231-16 (Economy)
		30/200-65KT	13"	30/221-70 TC 21Z 25.4x29.5 (1688207M91)	30/231-70 CD (3700527M1)
	13" DV-G3 25Z	30/200-72 (3701015M92)	13"	30/221-72 TC-LS 21Z 25.4x29.5 (3701011M91)	30/230-1 AV (828123M2)
550	10"/12" 250/300 GA3	30/200-7 (3599463M92)	10" LK	30/212-6 UF 25Z 38x41 (3478359M91)	
			12" LN	30/221-3 UF 10Z 23x29 (3599462M92)	
	12" LN	30/221-62 UC 10Z 23x29 (887890M93)			
	12" NV-G3 25Z	30/200-61 (3599491M92)	12" LN	30/221-3 UF 10Z 23x29 (3599462M92)	
			12" LN	30/221-62 UC 10Z 23x29 (887890M93)	

Les références des pièces sont indicatives.
Nos pièces ne sont pas d'origine

Part numbers are quoted for reference purposes only.
Our parts and accessories are not original.



MECANISMES & DISQUES D'EMBRAYAGE CLUTCH ASSEMBLIES & PLATES

Légendes voir page 232 - Figures voir pages 233-236 - Key See page 232 - Figures see pages 233-236

Tracteurs Tractors	Embrayage Clutch		Disque Plate		Butée de débrayage Release bearing
	Ø	N°	Ø	N°	
560, 565, 575, 675	10"/12" 250/300 GA3	30/200-8 (3599464M92)	10" LK	30/212-6 UF 25Z 38x41 (3478359M91)	
			12" LN	30/221-3 UF 10Z 23x29 (3599462M92)	
			12" LN	30/221-62 UC 10Z 23x29 (887890M93)	
	12" NV-G3 25Z	30/200-62 (3599494M92) 30/200-62KT	12" LN	30/221-3 UF 10Z 23x29 (3599462M92)	
			12" LN	30/221-62 (887890M93)	
590, 690	10"/12" 250/300 GA3	30/200-9 (3610268M92)	10" LK	30/212-6 UF 25Z 38x41 (3478359M91)	
			12" LN	30/221-3 UF 10Z 23x29 (3599462M92)	
			12" LN	30/221-62 UC 10Z 23x29 (887890M93)	
	12" NV-G3 25Z	30/200-63 (3599496M93) 30/200-63KT	12" LN	30/221-3 UF 10Z 23x29 (3599462M92)	30/230-1 AV (828123M2)
12" LN			30/221-62 UC 10Z 23x29 (887890M93)		
592 595 (⇒ Z214004)	12" NV-G3 25Z	30/200-67 (1808749M94)	12" LN	30/221-63 UF 10Z 23x29 (3620400M92)	
			12" LN	30/221-64 UC 10Z 23x29 (1670234M91)	
592 595 (Z214005 ⇒) 698 (UK)	13" NO-G3 25Z	30/200-68 (3620413M91)	13"	30/221-65 UF 10Z 23x29 (3610281M92)	
			13"	30/221-66 UC 10Z 23x29 (1688187M91)	
698 (France)	13" NV-G3 25Z	30/200-70 (3599492M91)	13"	30/221-69 TF 21Z 25.4x29.5 (3599461M92)	
			13"	30/221-70 TC 21Z 25.4x29.5 (1688207M91)	

Les références des pièces sont indicatives.
Nos pièces ne sont pas d'origine

Part numbers are quoted for reference purposes only.
Our parts and accessories are not original.

MF-228



"THE RELIABLE SERVICE"



Ed.1 (07/04)

MECANISMES & DISQUES D'EMBRAYAGE CLUTCH ASSEMBLIES & PLATES

Légendes voir page 232 - Figures voir pages 233-236 - Key See page 232 - Figures see pages 233-236

Tracteurs Tractors	Embrayage Clutch		Disque Plate		Butée de débrayage Release bearing
	Ø	N°	Ø	N°	
698T	13" NV-G3 25Z	30/200-69 (3620414M91)	13"	30/221-65 UF 10Z 23x29 (3610281M92)	
			13"	30/221-66 UC 10Z 23x29 (1688187M91)	
699	13" NV-G3 25Z	30/200-70 (3599492M91)	13"	30/221-70 TC 21Z 25.4x29.5 (1688207M91)	30/231-1 64x103x23 (892862M3) 30/231-16 (Economy)
			13"	30/221-72 TC-LS 21Z 25.4x29.5 (3701011M91)	
1004	13" NO-G3 25Z	30/200-68 (3620413M91)	13"	30/221-65 UF 10Z 23x29 (3610281M92)	30/231-70 CD (3700527M1) 30/230-1 AV (828123M2)
			13"	30/221-66 UC 10Z 23x29 (1688187M91)	
1004T	13" NV-G3 25Z	30/200-70 (3599492M91)	13"	30/221-65 UF 10Z 23x29 (3610281M92)	
			13"	30/221-70 TC 21Z 25.4x29.5 (1688207M91)	
1007	310/310 LUK GU6	30/200-254L (3540478M91)	310 LG	30/221-97L TC 14Z 35x40 (3310761M91)	30/231-61 MS 50x94x21 (1423473M94) 30/231-68 MT 65x100x11 (1442381X1) 30/230-24 AV (339599X1)
			310 LM	30/212-57L UF 10Z 22x25 (3301234M91)	
1014 (⇒ 22904564)	310/310 LUK GU6	30/200-253L (3302477M92)	310 LG	30/221-97L UC 23Z 44x48 (3310761M91)	30/231-67 55x92x32 (3302143M91)
			310 LM	30/212-57L UF 16Z 27x30 (3301234M91)	
			310 LM	30/212-57 UF 16Z 27x30	
1007 1014 (22904565 ⇒) 1114, 1134	330/330 LUK GU6	30/200-255L (3303137M95)	310 LG	30/221-96L TC-LY 23Z 44x48 (3105364M92)	30/231-62 MS 55x92.5x30 (1425227M91) 30/231-69 MT 75x115x13 (392191X1)
			310 LM	30/212-59L UF 16Z 27x30 (1426390M94)	
			310 LM	30/212-59 UF 16Z 27x30	

Les références des pièces sont indicatives.
Nos pièces ne sont pas d'origine

Part numbers are quoted for reference purposes only.
Our parts and accessories are not original.



MECANISMES & DISQUES D'EMBRAYAGE CLUTCH ASSEMBLIES & PLATES

Légendes voir page 232 - Figures voir pages 233-236 - Key See page 232 - Figures see pages 233-236

Tracteurs Tractors	Embrayage Clutch		Disque Plate		Butée de débrayage Release bearing
	Ø	N°	Ø	N°	
1080, 1085	12" NV-G3 25Z	30/200-67 (1808749M94)	12" LN	30/221-63 UF 10Z 23x29 (3620400M92)	30/231-1 64x103x23 (892862M3)
			12" LN	30/221-64 UC 10Z 23x29 (1670234M91)	
2200	9"/11"	30/200-1 (3620401M91) 30/200-1KT	9" LK	30/212-1 UF 10Z 39x45 (3620411M91)	30/231-16 (Economy) 30/230-1 AV (828123M2)
	9"/11" GA3 LUK	30/200-1L 228005741	11" LN	30/221-1 UF 10Z 23x29 (3620410M92)	
2205, 2210, 2220	280/280 TGU6 LUK	30/200-270 (3553259M91)	280 LG	30/221-270 TF 18Z 31x35 (3540866M92)	
			280 LM	30/212-270 UF 18Z 19x22 (3540951M91)	
2210, 2220	280 DF LUK	30/200-271 (3540865M91)	280	30/221-270 TF 18Z 31x35 (3540866M92)	
2620, 2625, 2640, 2645, 2680, 2685, 2720, 2725	14" 350 DV	30/200-75 (3381122M2) 30/200-75KT	14"	30/221-75 UC-LY 23Z 46.6x51 (3615367M1)	30/231-17 65x111x45 (3384863M93)
3050, 3055, 3060, 3065, 3070, 3075, 3080, 3090 3085, 3095 (⇒ C329040) (⇒ C280041)	13" 330 DV	30/200-73 (3382762M1) 30/200-73KT (Avec / With 30/231-17) 30/200-54K (Sans / Without 30/231-17)	13" 13"	30/221-73 UC-MH 23Z 46.6x51 (3615366M1) 30/221-232 UF 23Z 46.6x51	30/231-17 65x111x45 (3384863M93) ⇒ C340005 30/231-65 65x105x27 (3617197M2) C340006 ⇒ Dynashift
3085, 3095 (C329041 ⇒) (C280042 ⇒) 3075, 3080, 3090 3115, 3120, 3125	13" 330	30/200-252 (3618886M1) 30/200-66KT	13" 13"	30/221-73 UC-MH 23Z 46.6x51 (3615366M1) 30/221-232 UF 23Z 46.6x51	30/231-64 (3583491M1)
3610, 3630, 3635, 3645, 3650, 3655, 3670	14" 350 DV	30/200-75 (3381122M2) 30/200-75KT	14"	30/221-75 UC-LY 23Z 46.6x51 (3615367M1)	30/231-17 65x111x45 (3384863M93) 30/231-65 65x105x27 (3617197M2) Dynashift

Les références des pièces sont indicatives.
Nos pièces ne sont pas d'origine



"THE RELIABLE SERVICE"



Part numbers are quoted for reference purposes only.
Our parts and accessories are not original.

MF-230

Ed.1 (07/04)

MECANISMES & DISQUES D'EMBRAYAGE CLUTCH ASSEMBLIES & PLATES

Légendes voir page 232 - Figures voir pages 233-236 - Key See page 232 - Figures see pages 233-236

Tracteurs Tractors	Embrayage Clutch		Disque Plate		Butée de débrayage Release bearing
	Ø	N°	Ø	N°	
3670, 3680, 3690	12"/12" 310/310 ZW6	30/200-76 (3713264M91) <i>Complet avec 2 disques Complete with 2 plates</i>	12"	30/221-76 TC-LY 23Z 46.6x51 (3713266M1)	30/231-63 (3583029M3) 30/231-66 (3617198M3) <i>Dynashift</i>
4220, 4225, 4235, 4240	12" NV-G3 25Z 12" NV-G3 25Z	30/200-405L (3701014M92) 13105110 30/200-68 (3620413M91)	12" LN 12" LN	30/221-71 TC-LS 21Z 25.4x29.5 (3701009M91) 30/221-68 UC-LS-AA 21Z 25.4x29.5 (3701008M91)	30/231-1 64x103x23 (892862M3) 30/231-16 <i>(Economy)</i>
4215	12" NV-G3 25Z	30/200-63 (3599496M93)	12" LN	30/221-36 TF 21Z 25.4x29.5 (3599460M92)	30/231-70 CD (3700527M1)
4245, 4255, 4260, 4265, 4270	13" DV-G3 25Z	30/200-72 (3701015M92)	13"	30/221-72 TC-LS 21Z 25.4x29.5 (3701011M91)	
 Industriels / Industrials 50B, 50B MKII, 50D, 50H, 50HX, 60H	12"	30/200-64 (887869M91)	12" LN	30/221-62 UC 10Z 23x29 (887890M93)	30/231-1 64x103x23 (892862M3) 30/230-1 AV (828123M2)
Tracteurs Tractors			Amortisseur de torsion Torsion damper		Butée de débrayage Release bearing
3050, 3060, 3065, 3075, 3085, 6120, 6130, 6140, 6150, 6160, 6235, 6245, 6255, 6260, 6265 <i>Avec inverseur mécanique With mechanical shuttle</i>			30/196-6 26Z 39.9x42.8 (3714122M4)		
6170, 6180, 6190, 6260, 6270, 6280, 6290 <i>Avec inverseur sous couple With power shuttle</i>			30/196-2 26Z 39x42.5 (3790734M3)		30/230-270 52x25x15 (339581X1)
6235, 6245, 6255, 6265 <i>Avec inverseur sous couple With power shuttle</i>			30/196-3 26Z 39x42.5 (3792448M2)		
8110, 8120, 8130, 8140, 8150, 8210, 8220, 8230, 8240, 8250, 8260 <i>Dynashift</i>			30/196-4 26Z 39x42.5 (3790735M2)		30/230-271 62x30x16 (339583X1)
8210, 8220, 8230, 8240, 8250, 8260, 8270, 8280 <i>Powershift</i>			30/196-5 26Z 39x42.5 (3792346M1)		

Les références des pièces sont indicatives.
Nos pièces ne sont pas d'origine

Part numbers are quoted for reference purposes only.
Our parts and accessories are not original.



MECANISMES & DISQUES D'EMBRAYAGE CLUTCH ASSEMBLIES & PLATES

AH	Avec les 2 disques incorporés
AN	Renforcé
AU	Roulement pilote
BO	Cylindre récepteur avec butée
CD	Commande par câble
DF	Diaphragme, volant plat
DV	Diaphragme, volant creux
FO	Volant plat, sans bague d'appui
G3	3 doigts
G4	4 doigts
GA3	Commande combinée, 3 doigts
GI	Kit complet sans butée
GU6	Commande indépendante, 6 doigts
LG	Friction d'avancement côté BV, montée
LK	Friction prise de force côté BV, montée
LM	Friction prise de force côté moteur, libre
LN	Friction d'avancement côté moteur, libre
LQ	3 paires de pastilles
LR	4 paires de pastilles
LS	5 paires de pastilles
LT	6 paires de pastilles
LY	8 paires de pastilles
MH	7 paires de pastilles
MQ	Interchangeable avec VALEO
MS	Petit Ø
MT	Grand Ø
MV	Butée avec support
NM	PTO fixe, bague d'appui
NO	PTO fixe, volant plat
NV	PTO fixe, volant creux
NX	12 paires de pastilles
SM	Volant plat bague d'appui
TC	Cera-métallique à ressorts
TF	Organique à ressorts
UC	Cera-métallique fixe
UF	Organique fixe
ZW	2 disques identiques

AH	<i>Both driven plates built in</i>
AN	<i>Heavy duty</i>
AU	<i>Spigot bearing</i>
BO	<i>Slave cylinder and release bearing are one unit</i>
CD	<i>Cable command</i>
DF	<i>Diaphragm, flat flywheel</i>
DV	<i>Diaphragm, pot flywheel</i>
FO	<i>Flat flywheel whithout release plate</i>
G3	<i>3 levers</i>
G4	<i>4 levers</i>
GA3	<i>Combined clutch, 3 levers</i>
GI	<i>Assembly kit without release bearing</i>
GU6	<i>Independent clutch, 6 levers</i>
LG	<i>Main disc, transmission side, mounted</i>
LK	<i>PTO disc, transmission side, mounted</i>
LM	<i>PTO disc, engine side, loose</i>
LN	<i>Main disc, engine side, loose</i>
LQ	<i>3 pairs of pads</i>
LR	<i>4 pairs of pads</i>
LS	<i>5 pairs of pads</i>
LT	<i>6 pairs of pads</i>
LY	<i>8 pairs of pads</i>
MH	<i>7 pairs of pads</i>
MQ	<i>Interchangeable with VALEO</i>
MS	<i>Small diameter</i>
MT	<i>Large diameter</i>
MV	<i>Release bearing with carrier</i>
NM	<i>PTO fixed with release plate</i>
NO	<i>PTO fixed flat flywheel</i>
NV	<i>PTO fixed flywheel</i>
NX	<i>12 pairs of pads</i>
SM	<i>Flat flywheel with release plate</i>
TC	<i>Spring cera-metallic</i>
TF	<i>Spring organic</i>
UC	<i>Fixed cera-metallic</i>
UF	<i>Fixed organic</i>
ZW	<i>2 same plates</i>

BUTÉES SERIES 3000 & 3600 / RELEASE BEARING 3000 & 3600 SERIES



VOLANTS MOTEUR FLYWHEEL ASSEMBLIES

Tracteurs Tractors	Réf. Ref.	OEM
165 (A4.212), 168, 175, 178, 185, 188 (Embr./Clutch 12"), 265, 275, 285, 290, 362, 362N, 365, 372N, 375, 382N, 390 (LF31141, LF31249), 565, 575, 590, 675, 690, 4225, 4235, 4240 (Embr./Clutch 12"), 4325, 4335	30/296-10	3819666M92
373, 373LX/S 374, 384, 394 AP(X)/AQ/FP(X)/FQ/GE(X)/SP(X)/SQ/V/VQ 376C, 377, 383, 383LX/S, 387, 393, 393LX/S/TLX, 396C/CT, 397, 397T, 1007 3220, 3225, 3235 AP(X)/FP(X)/GE(X)/SP(X)	30/296-4	3532476M1
3050, 3060, 3065, 3070	30/296-7	3382759M91



Les références des pièces sont indicatives.
Nos pièces ne sont pas d'origine

*Part numbers are quoted for reference purposes only.
Our parts and accessories are not original.*



"THE RELIABLE SERVICE"



MECANISMES & DISQUES D'EMBRAYAGE
CLUTCH ASSEMBLIES & PLATES

30/196-2

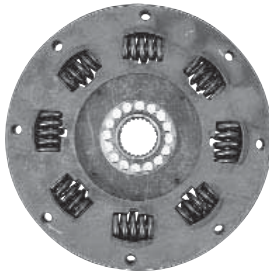

30/196-3

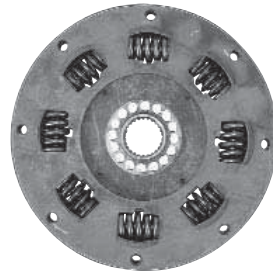

30/196-4

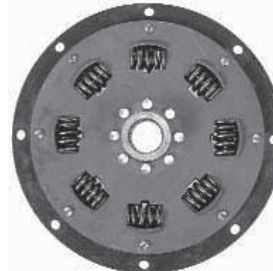

30/196-5



30/196-6

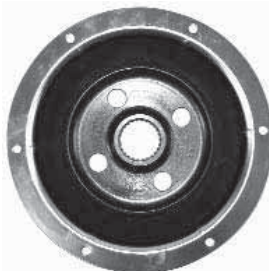

30/200-1(L)

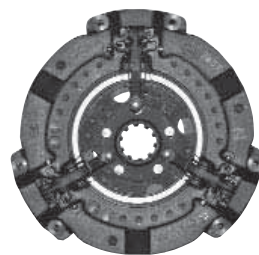

30/200-2

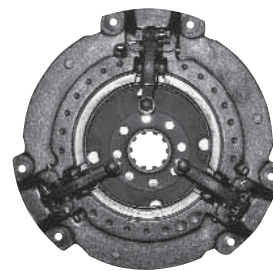

30/200-3

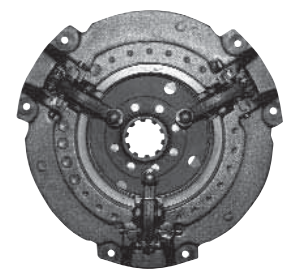

30/200-4

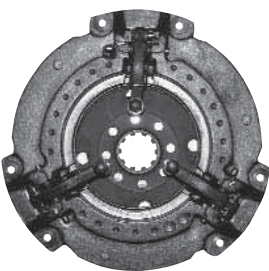

30/200-6

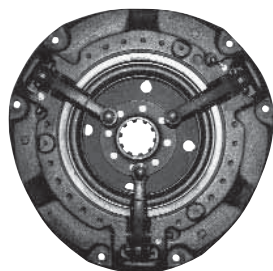

30/200-7

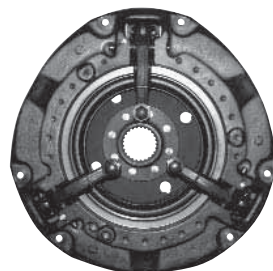

30/200-8



30/200-9



30/200-61

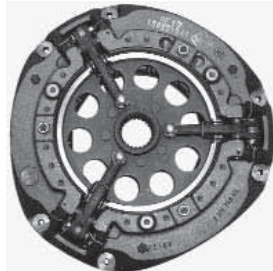

30/200-62

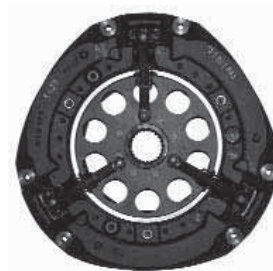

30/200-63

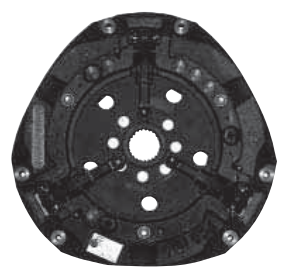

30/200-66

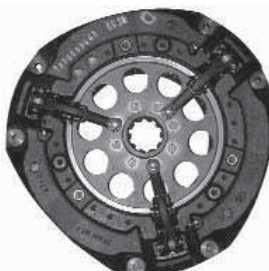

30/200-67

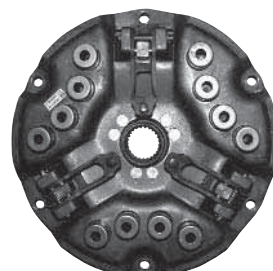

30/200-68

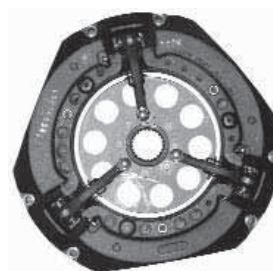

30/200-69



Les références des pièces sont indicatives.
Nos pièces ne sont pas d'origine

Part numbers are quoted for reference purposes only.
Our parts and accessories are not original.



MECANISMES & DISQUES D'EMBRAYAGE
CLUTCH ASSEMBLIES & PLATES

30/200-70

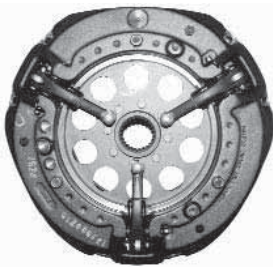

30/200-71

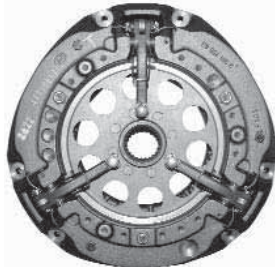

30/200-72

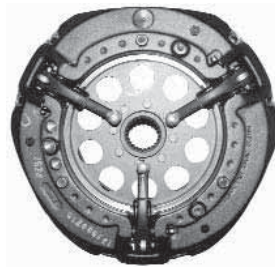

30/200-73

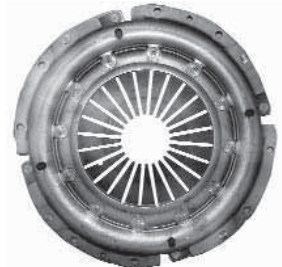

30/200-75



30/200-76



30/200-251

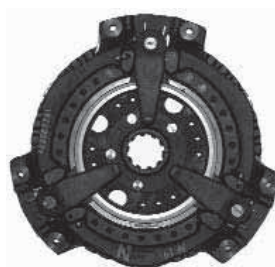

30/200-252

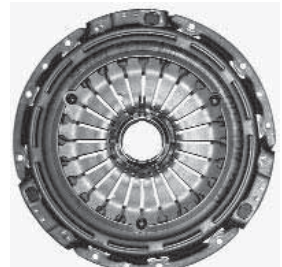

30/200-253L



30/200-254L

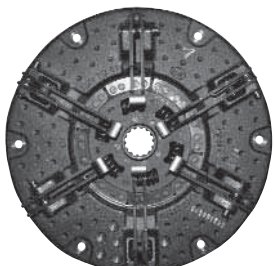

30/200-255L



30/200-270



30/200-271



30/200-272



30/200-402L



30/200-403L

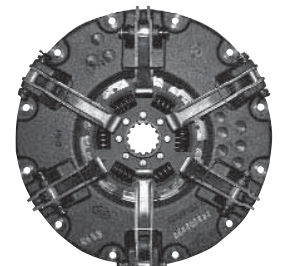

30/200-405L



Les références des pièces sont indicatives.
Nos pièces ne sont pas d'origine

Part numbers are quoted for reference purposes only.
Our parts and accessories are not original.



MECANISMES & DISQUES D'EMBRAYAGE
CLUTCH ASSEMBLIES & PLATES

30/212-1

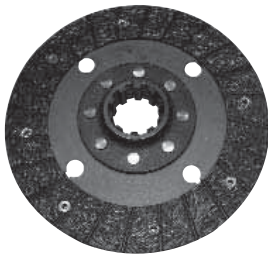

30/212-4

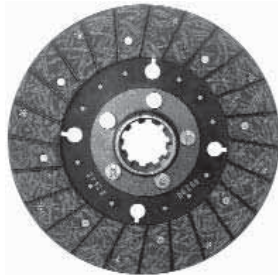

30/212-6

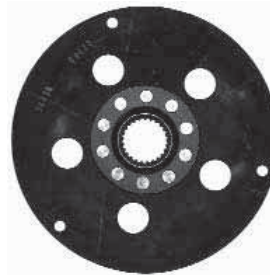

30/212-55L



30/212-56



30/212-57

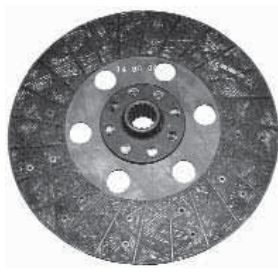

30/212-58L



30/212-59

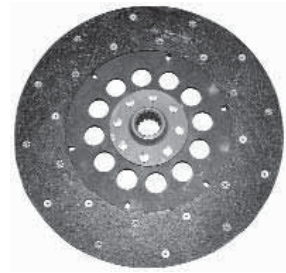

30/212-270

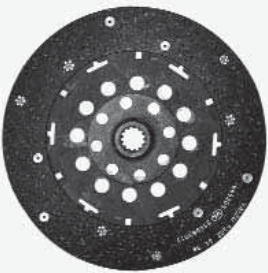

30/221-1

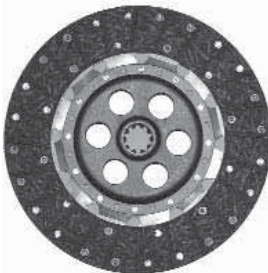

30/221-3



30/221-36

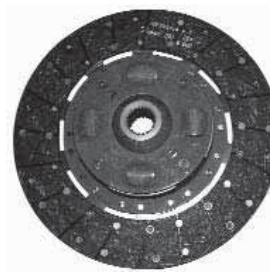

30/221-37

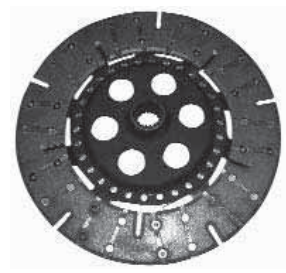

30/221-38



30/221-61



30/221-62

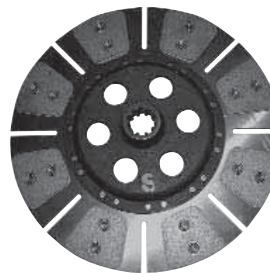

30/221-63



Les références des pièces sont indicatives.
Nos pièces ne sont pas d'origine

Part numbers are quoted for reference purposes only.
Our parts and accessories are not original.



"THE RELIABLE SERVICE"



MECANISMES & DISQUES D'EMBRAYAGE
CLUTCH ASSEMBLIES & PLATES

30/221-64

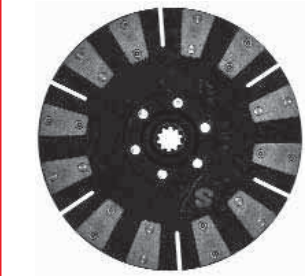

30/221-65

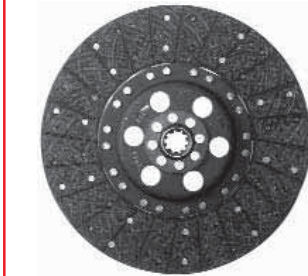

30/221-66

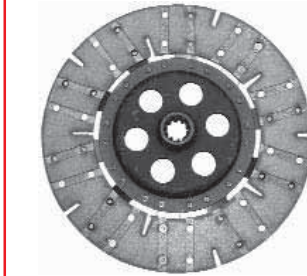

30/221-68

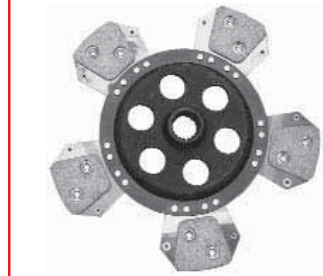

30/221-69

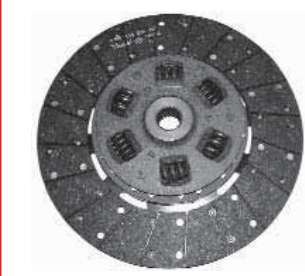

30/221-70

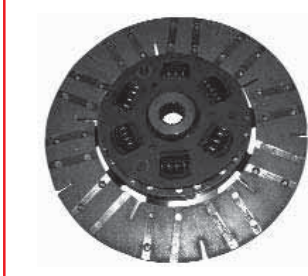

30/221-71

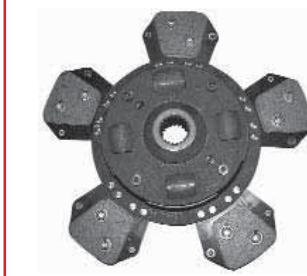

30/221-72

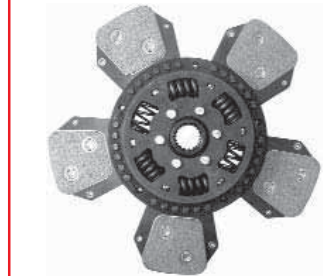

30/221-73

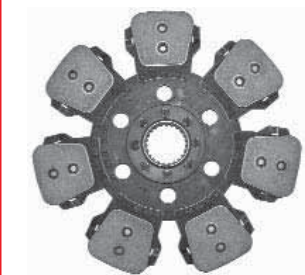

30/221-75

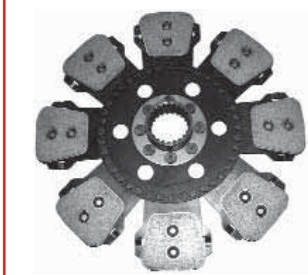

30/221-76

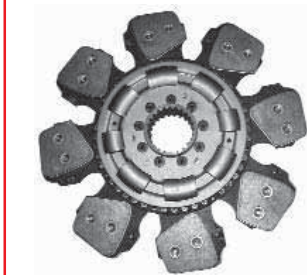

30/221-91

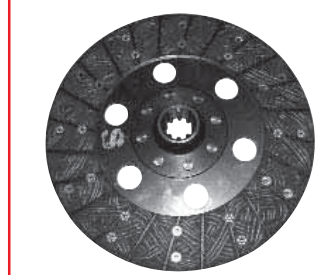

30/221-93

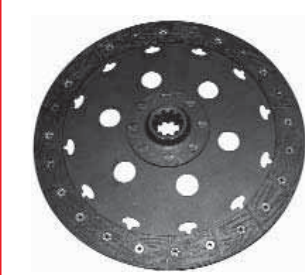

30/221-94



30/221-95L

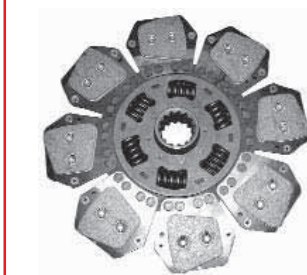

30/221-96L

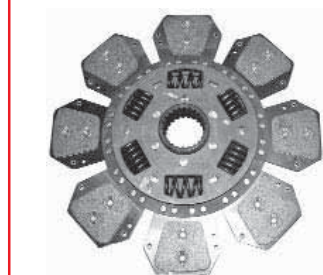

30/221-232

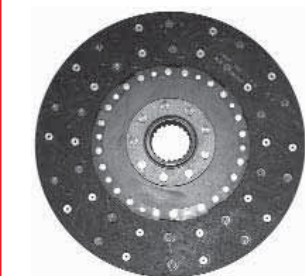

30/221-270

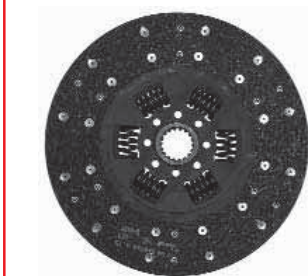

30/221-411

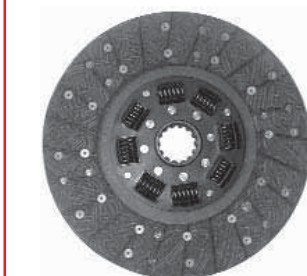

30/221-412

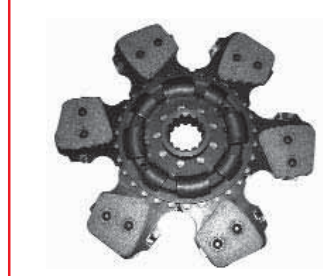

Les références des pièces sont indicatives.
Nos pièces ne sont pas d'origine

Part numbers are quoted for reference purposes only.
Our parts and accessories are not original.

MF-236



"THE RELIABLE SERVICE"



Ed.1 (07/04)

PIECES DÉTACHÉES POUR MECANISMES D'EMBRAYAGE LAYCOCK
SPARE PARTS FOR LAYCOCK CLUTCHES

EMBRAYAGE DOUBLE / DUAL CLUTCH

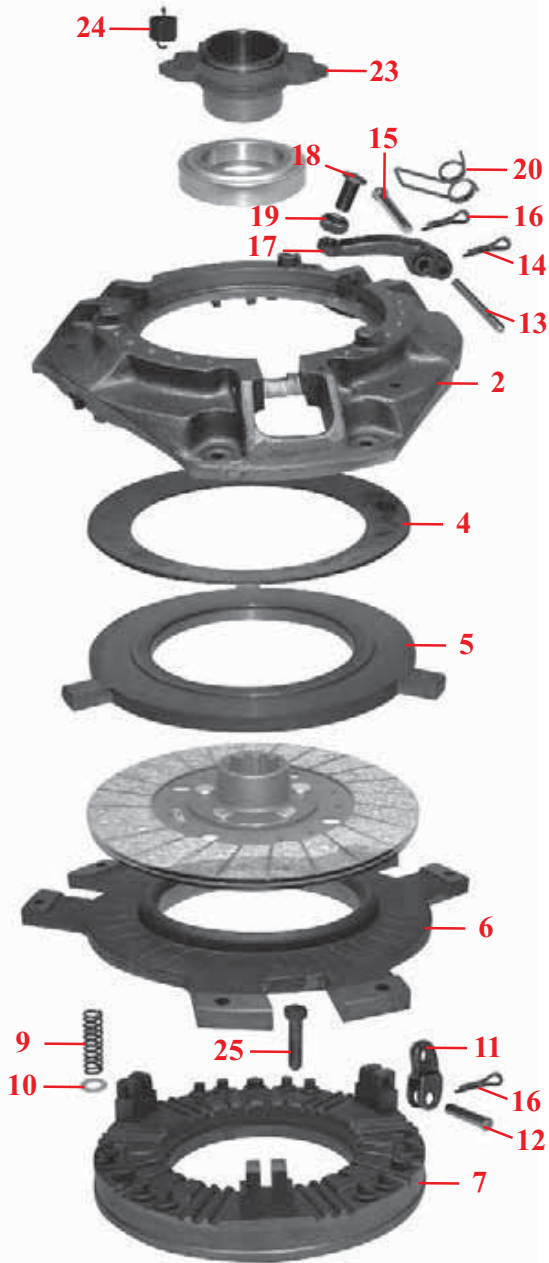

EMBRAYAGE SIMPLE / SINGLE CLUTCH

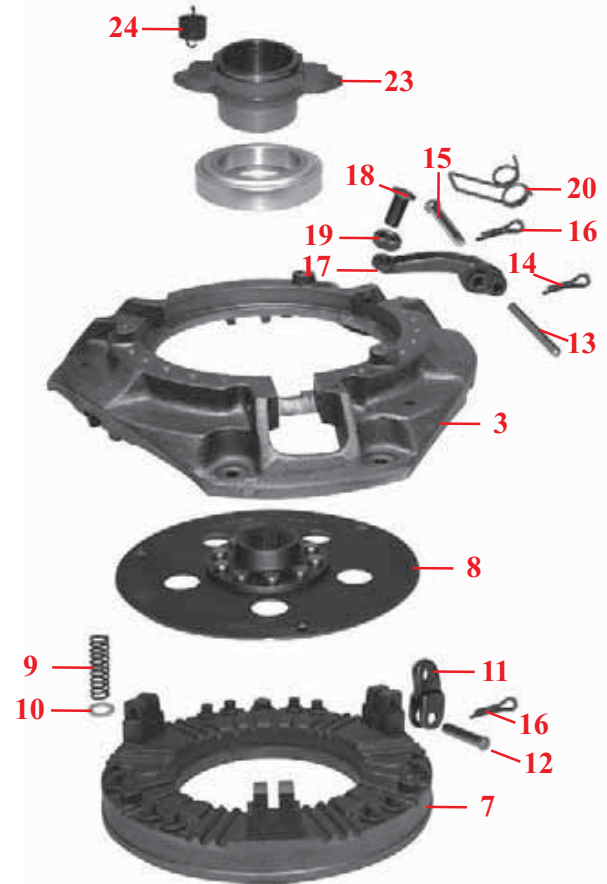

Les références des pièces sont indicatives.
Nos pièces ne sont pas d'origine

Part numbers are quoted for reference purposes only.
Our parts and accessories are not original.



PIECES DÉTACHÉES POUR MECANISMES D'EMBRAYAGE LAYCOCK SPARE PARTS FOR LAYCOCK CLUTCHES

280mm - 11"

Fig.	Réf. Ref.	OEM	Description
1	30/222-1	891386M92	Jeu de garniture d'avancement 11" / <i>Facing kit 11"</i>
2	30/201-1	886399M1	Couvercle 11" double / <i>11" double cover</i>
5	30/211-1	181103M1	Plateau de prise de force 11" épaisseur 9.5mm / <i>11" PTO press plate Thickness 9.5mm</i>
	30/211-2	881934M1	Plateau de prise de force 11" épaisseur 11mm / <i>11" PTO press plate Thickness 11mm</i>
6	30/214-1	1753748M1	Plateau de friction 11" / <i>11" Friction plate</i>
7	30/217-1	1860158M1	Plateau primaire 11" / <i>11" Main press plate</i>
	30/218-1	1860161M91	Plateau primaire 11" + jeu de leviers / <i>11" Main press plate + lever set</i>
9	30/215-5	1753746M1	6 x
		1753745M1	6 x
		887909M1	6 x
		886632M1	9 x
		886396M1	12 x
		Ressort de pression / <i>Release spring</i>	
10	30/216-1	1753751M1	Jeu de 12 rondelles / <i>12 washer set</i>
11	30/219-1	899817M1	Biellette 11" (6 par mécanisme) / <i>11" toggle link (6 per assembly)</i>
	30/219-2	1860159M1	Jeu de 3 biellettes 11" (3 par mécanisme) / <i>11" toggle link set of 3 (3 per assembly)</i>
12	30/220-1	1028657M1	Jeu de 3 axes pour 30/219-1 (11") / <i>3 link pin set for 219-1 (11")</i>
	30/220-2	1860160M1	Jeu de 3 axes pour 30/219-2 (11") / <i>3 link pin set for 219-2 (11")</i>
13	30/206-1	828597M2	Pivot / <i>Pivot pin</i>
	30/206-2	891826M1	Jeu de 3 pivots / <i>3 pivot pin set</i>
14	30/207-2	891827M1	Jeu de 3 goupilles / <i>3 pin set</i>
	30/207-1	354055X1	Goupille pour 30/206-1 / <i>Pin for 30/206-1</i>
15	30/204-1	1753965M2	Jeu de 3 pivots 11" / <i>11" 3 link pin set</i>
16	30/205-1	354048X1	Goupille pour 30/204-1 & 30/204-2 / <i>Cotter pin for 30/204-1 & 30/204-2</i>
17	30/202-1	899818M2	Jeu de 3 leviers 11" / <i>11" 3 lever set</i>
18	30/208-1	1853164M1	Jeu de 3 vis / <i>3 screw set</i>
19	30/209-1	353430X1	Ecrou pour 30/208-1 / <i>Lock nut for 30/208-1</i>
20	30/203-1	893121M2	Jeu de 3 ressorts 11" / <i>11" 3 tension spring set</i>
21	30/224-1	1810855M92	Jeu de réparation 11" comprenant : <i>11" repair kit, content :</i>
			30/202-1, 30/203-1, 30/204-1, 30/205-2, 30/206-2, 30/207-2, 30/208-1, 30/209-1, 30/216-1, 30/219-2, 30/220-2
22	30/225-1	B8761	Jeu de réparation 11" comprenant : <i>11" repair kit, content :</i>
			30/202-1, 30/203-1, 30/208-1, 30/209-1, 30/231-1
23	30/232-1	183129M2	Porte butée 11" / <i>11" Release bearing carrier</i>
24	30/233-1	1867690M2	Ressort de porte butée / <i>Release bearing carrier spring</i>
25	30/223-1	181124M1	Vis de réglage pour plateau double 11 & 12" / <i>11" & 12" double plate adjusting screw</i>

Les références des pièces sont indicatives.
 Nos pièces ne sont pas d'origine

Part numbers are quoted for reference purposes only.
 Our parts and accessories are not original.



PIECES DÉTACHÉES POUR MECANISMES D'EMBRAYAGE LAYCOCK SPARE PARTS FOR LAYCOCK CLUTCHES

310mm - 12"

Fig.	Réf. Ref.	OEM	Description	
1	30/222-2	3900173M91	Jeu de garniture d'avancement 12" / Facing kit 12"	
2	30/201-2	887896M1	Couvercle 12" double / 12" double cover	
3	30/201-3	887895M1	Couvercle 12" simple / 12" single cover	
4	30/210-9	887906M1	Ressort Belleville 12" / 12" Belleville washer	175, 178, 185, 188, 285, 290, 375, 390, 575, 590, 690
5	30/211-3	887903M1	Plateau de prise de force 12" / 12" PTO press plate	
6	30/214-2	887902M1	Plateau de friction 12" / 12" Friction plate	
7	30/217-2	3477544M1	Plateau primaire 12" / 12" Main press plate	
	30/218-2	1810909M91	Plateau primaire 12" + jeu de leviers / 12" Main press plate set + lever set	
8	30/212-17	887899M93	Disque intermédiaire 12" - 10 cannelures / 12" Intermediate plate - 10 teeth	
	30/212-16	3478569M92	Disque intermédiaire 12" - 25 cannelures / 12" Intermediate plate - 25 teeth	
9	30/215-5	1753746M1	6 x	Ressort de pression / Release spring
		1753745M1	6 x	
		887909M1	6 x	
		886632M1	9 x	
		886396M1	12 x	
10	30/216-1	1753751M1	Jeu de 12 rondelles / 12 washer set	
11	30/219-3	3900547M1	Jeu de 3 biellettes 12" (3 par mécanisme) / 12" toggle link set of 3 (3 per assembly)	
12	30/220-3	887893M1	Jeu de 3 axes (12") / 3 link pin set (12")	
13	30/206-1	828597M2	Pivot / Pivot pin	35 (⇒ 80003), 65 & 765 (⇒ 538999)
	30/206-2	891826M1	Jeu de 3 pivots / 3 pivot pin set	
14	30/207-2	891827M1	Jeu de 3 goupilles / 3 pin set	
	30/207-1	354055X1	Goupille pour 30/206-1 / Pin for 30/206-1	
15	30/204-2	887897M1	Jeu de 3 pivots 12" / 12" 3 link pin set	
16	30/205-1	354048X1	Goupille pour 30/204-1 & 30/204-2 / Cotter pin for 30/204-1 & 30/204-2	
17	30/202-2	887898M1	Lever 12" / 12" lever	
18	30/208-1	1853164M1	Jeu de 3 vis / 3 screw set	
19	30/209-1	353430X1	Ecrou pour 30/208-1 / Lock nut for 30/208-1	
20	30/203-2	887910M1	Jeu de 3 ressorts 12" / 12" 3 tension spring set	
21	30/224-2	1810857M92	Jeu de réparation 12" & 13" comprenant : 12" & 13" repair kit, content :	30/202-2, 30/203-2, 30/204-2, 30/205-2, 30/206-2, 30/207-2, 30/208-1, 30/209-1, 30/216-1, 30/219-3, 30/220-3
22	30/225-2	B8762	Jeu de réparation 12" & 13" comprenant : 12" & 13" repair kit, content :	30/202-2, 30/203-2, 30/208-1, 30/209-1, 30/231-1
23	30/232-2	886727M4	Porte butée 12" & 13" / 12" & 13" Release bearing carrier	
24	30/233-1	1867690M2	Ressort de porte butée / Release bearing carrier spring	
25	30/223-1	181124M1	Vis de réglage pour plateau double 11 & 12" / 11" & 12" double plate adjusting screw	

Les références des pièces sont indicatives.
Nos pièces ne sont pas d'origine

Part numbers are quoted for reference purposes only.
Our parts and accessories are not original.



COMMANDE D'EMBRAYAGE CLUTCH CONTROL

35, 65, Séries 100, 200, 300, 1200 series

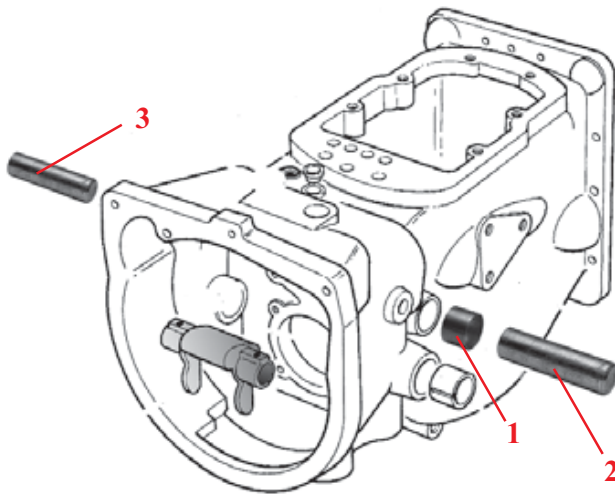
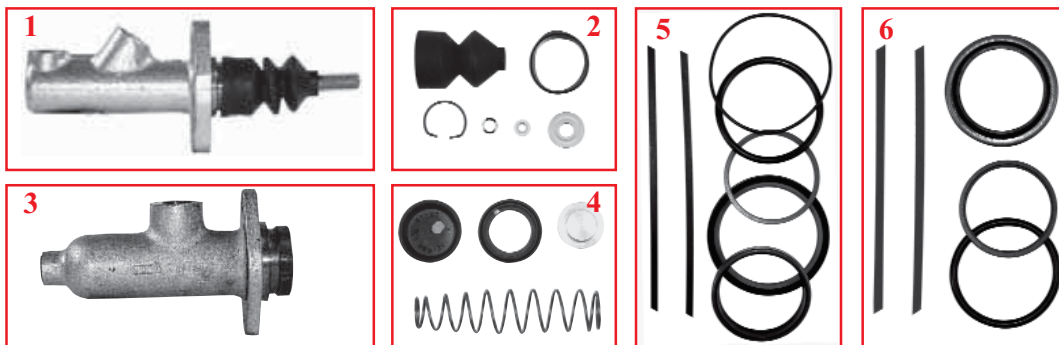

Fig.	Réf. Ref.	OEM	Description
1	30/234-1	184592M1	Bague d'arbre d'embrayage Clutch shaft bush
2	30/235-1	180444M2	Arbre de fourchette Pedal shaft
3	30/236-1	180449M1	Arbre de fourchette Release shaft

MAÎTRE-CYLINDRES ET CYLINDRE RECEPTEUR D'EMBRAYAGE CLUTCH MASTER AND SLAVE CYLINDERS



Tracteurs Tractors	Fig.	Réf. Ref.	OEM	Description
Série 3000 series 3115, 3120, 3125	1	30/226-9	3388831M4	Maître cylindre / Master cylinder
	2	30/227-5	1810834M91	Jeu de réparation / Repair kit
Séries 2600, 2700, 3000 (Dynashift), 3100, 3600, 6100, 6200, 8100, 8200 series	3	30/226-12	1613986M4	Maître cylindre / Master cylinder
	4	30/227-12	1642034M91	Jeu de réparation / Repair kit
Série 3000 series	5	30/229-13	3600207M94	Jeu de réparation cyl. recepneur
Série 3000 (Dynashift) series	6	30/229-14	3900423M91	Slave cyl. Repair kit

RESSORT DE PEDALE D'EMBRAYAGE CLUTCH PEDAL SPRING

30/233-10
(981843M3)



134C, 154/C, 174/C, 184, 194, 233, 234C/CF/S, 244CF, 253, 254/C/CF, 263T, 264T/TCF, 273, 274/C/CF/SK, 283, 284/S, 293, 294/C/S, 333, 353/LX/S, 356CF, 363/LX/S, 364CF, 366CF, 367CF, 373/LX/S, 376C/CF/XCF, 377, 383LX/S, 387, 393/LX/S/TLX, 394C, 396C/CF/CT, 397, 397T, 1007, 1014, 1024, 1104, 1114, 1134

VERIN DE PEDALE D'EMBRAYAGE CLUTCH PEDAL GAS STRUT

30/875-1
(3583941M1)



3670, 3680, 3690

Les références des pièces sont indicatives.
Nos pièces ne sont pas d'origine

Part numbers are quoted for reference purposes only.
Our parts and accessories are not original.



TRANSMISSION - SCHEMA GENERAL
TRANSMISSION - GENERAL ILLUSTRATION

8 vitesses / 8 speed

Cartier d'entrée/ Input housing
p 243

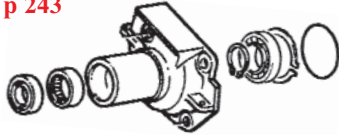

Pignon marche arrière
Reverse idler gear
p 263



Reducteur épicycloïdal
Epicyclic unit
p 254

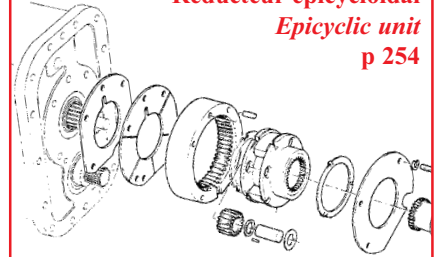

Arbre d'entrée / Input shaft
p 246-250

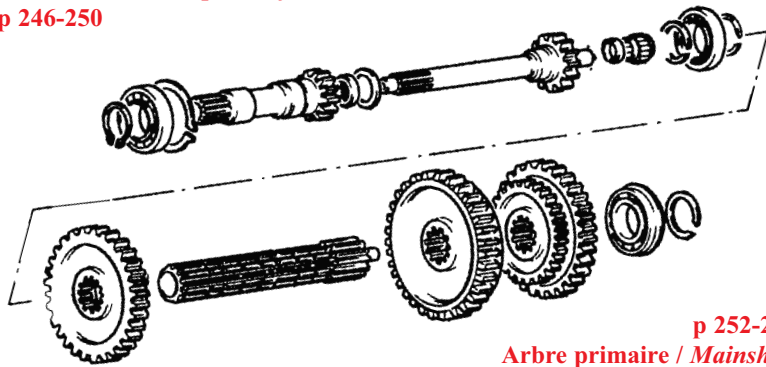

p 252-253
Arbre primaire / Mainshaft

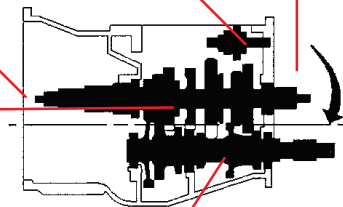

Arbre de prise de force / PTO drive shaft
p 255-257

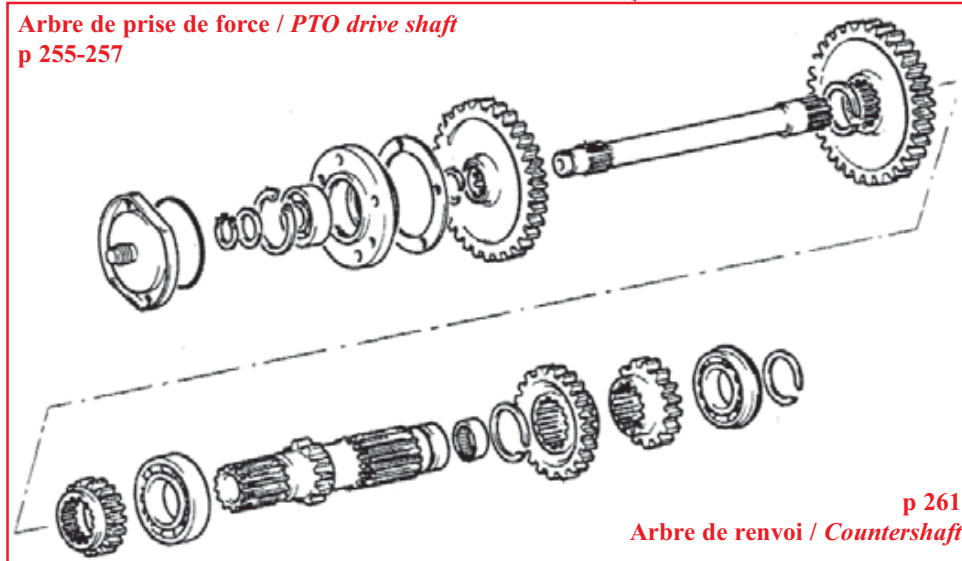

p 261
Arbre de renvoi / Countershaft

Les références des pièces sont indicatives.
Nos pièces ne sont pas d'origine

Part numbers are quoted for reference purposes only.
Our parts and accessories are not original.



TRANSMISSION - SCHEMA GENERAL
TRANSMISSION - GENERAL ILLUSTRATION

12 vitesses / 12 speed

Carter d'entrée/ Input housing
p 244

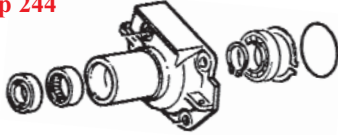

Pignon marche arrière
Reverse idler gear
p 264

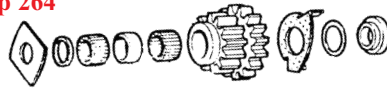

Reducteur épicycloïdal
Epicyclic unit
p 254

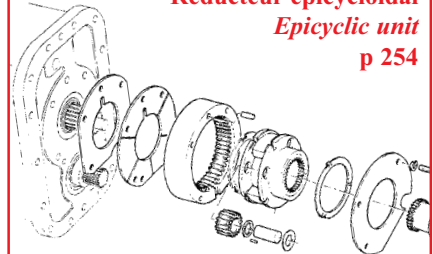

Arbre d'entrée / Input shaft
p 250-251, 266

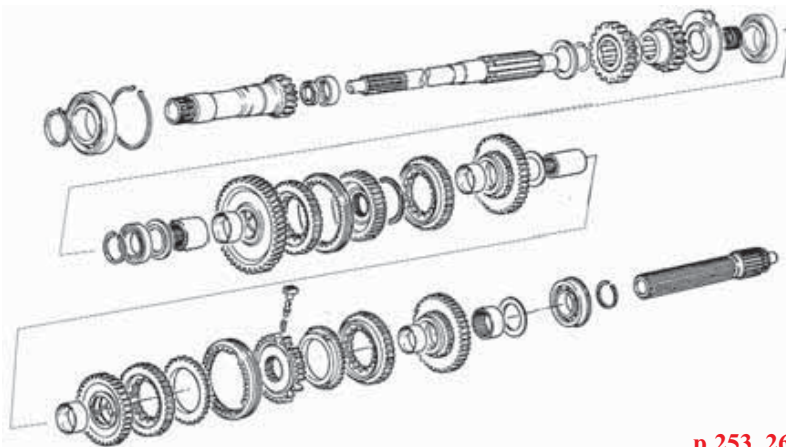

p 253, 267
Arbre primaire / Mainshaft

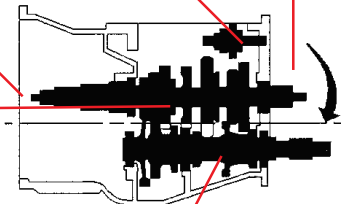

Arbre de prise de force / PTO drive shaft
p 258-260, 268

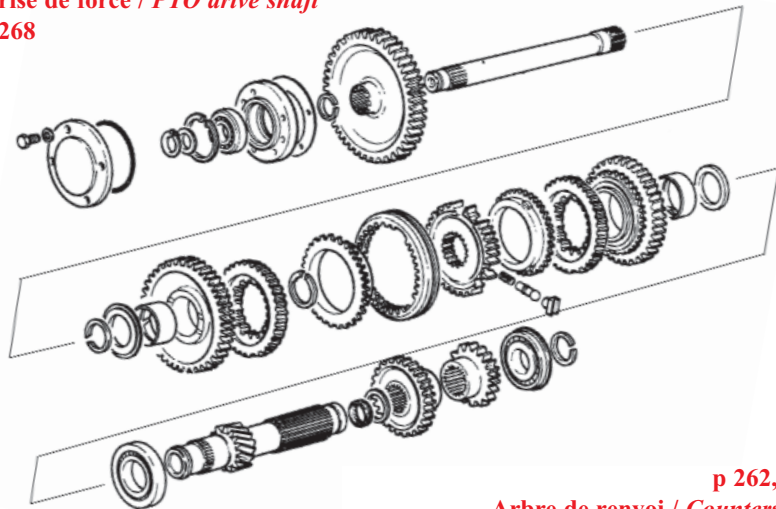

p 262, 268
Arbre de renvoi / Countershaft

Les références des pièces sont indicatives.
Nos pièces ne sont pas d'origine

Part numbers are quoted for reference purposes only.
Our parts and accessories are not original.

MF-242



"THE RELIABLE SERVICE"



Ed.1 (07/04)

TRANSMISSION - CARTER D'ENTREE
TRANSMISSION - INPUT HOUSING

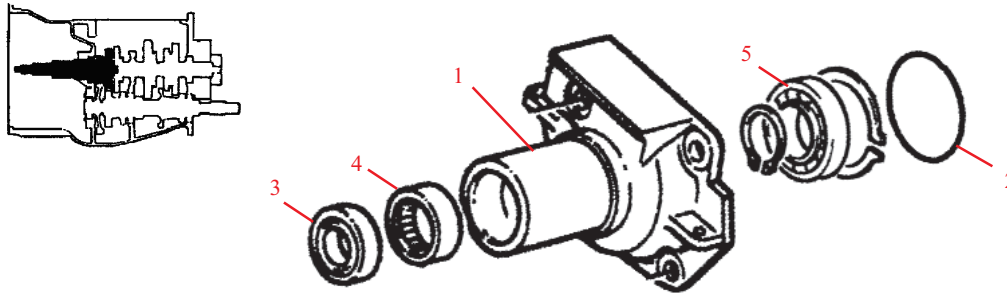

Fig.	1	2	3	4	5
Tracteurs Tractors	Carter Housing	Joint torique "O" ring	Bourrage Oil Seal	Coussinet Needle bearing	Roulement PTO drive bearing
Boîte 6 vitesses prise constante, embrayage simple (sans PDF) / 6 speed constant mesh single clutch (less PTO)					
35, 65, 133, 135, 140, 240, 835		30/249-1 (180434M1)	30/250-1 (195523M1)		
Boîte 6 vitesses prise constante, embrayage simple (avec PDF) / 6 speed constant mesh single clutch (with PTO)					
35, 65, 133, 135, 140, 145, 165, 175, 178, 240, 765, 865		30/249-1 (180434M1)	30/250-2 (195503M1)		30/252-1 (3009388X1)
Boîte 8 vitesses prise constante, synchronisées & synchron. inverseur / 8 speed constant mesh, synchromesh & synchromesh shuttle					
133, 135, 140, 148, 152, 155, 158, 165, 168, 185, 188, 230, 235, 240, 245, 255, 260, 265, 275, 275E, 285, 290, 290E	30/248-1 (1693833K92)				
253, 263, 340, 342, 350, 352, 355, 360, 362, 365, 375, 375E, 390, 390E, 390T, 396	30/248-1 (A) (1693833K92)				
550, 565 575, 590, 675 (2RM / 2WD)	30/248-1 (1693833K92)	30/249-2 (886089M1)	30/250-5 (1860867M5)	30/251-1 (886668M1)	30/252-2 (834303M1)
575, 590 (4RM / 4WD) 592, 595					
4215, 4220, 4225, 4235, 4240, 4245, 4255, 4315, 4320, 4325, 4335, 4345, 4355 8 x 2 Crash, 8 x 2 synchronisées, 8 x 8 inverseur 8 x 2 Crash, 8 x 2 synchromesh, 8 x 8 Shuttle					
Boîte de vitesses prise constante et synchronisée Multipower / Multipower constant mesh & synchromesh					
35, 65, 765		30/249-1 (180434M1)			
135, 148, 152, 165, 168, 175, 178, 185, 188		30/249-2 (B) (886089M1)	30/250-5 (B) (1860867M5)		30/252-2 (834303M1)
240, 250, 265, 275, 285, 290				30/251-1 (886668M1)	
365, 375, 390, 390T, 398, 399		30/249-2 (886089M1)	30/250-5 (1860867M5)		
550, 565, 575, 590, 595, 675, 690, 698, 698T, 699					
1080, 1200, 1250					

(A) Le carter est monté sur tous les 8 vitesses prise constante & synchronisée mais seulement sur les synchronisées avec inverseur ⇒ A37059
 (A) Housing fits 8 speed constant mesh & synchromesh but only fits synchromesh shuttle ⇒ A37059
 (B) Derniers modèles montés avec carter 1860889M91
 (B) Later models fitted with housing 1860889M91

Les références des pièces sont indicatives.
Nos pièces ne sont pas d'origine

Part numbers are quoted for reference purposes only.
Our parts and accessories are not original.



TRANSMISSION - CARTER D'ENTREE
TRANSMISSION - INPUT HOUSING

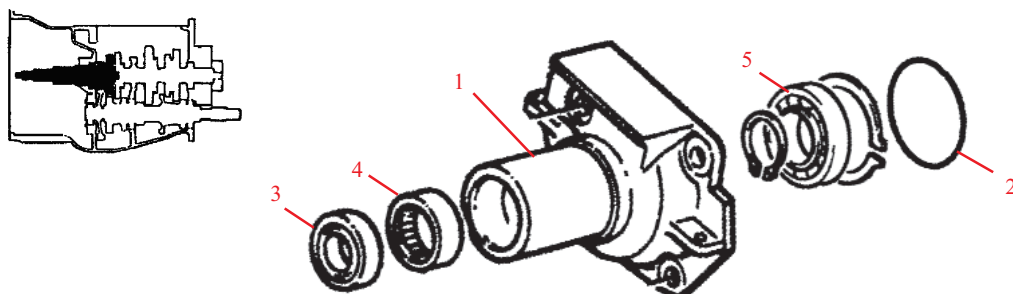

Fig.	1	2	3	4	5
Tracteurs Tractors	Carter Housing	Joint torique "O" ring	Bourrage Oil Seal	Coussinet Needle bearing	Roulement PTO drive bearing
Boîte 12 vitesses synchronisées & synchronisées inverseur / 12 speed synchronesh & synchronesh shuttle					
158 MKIII, 168 MKIII, 253, 260, 265, 275E, 290E 275, 290, 298 (2RM / 2WD)	30/248-1 (1693833K92)				
275, 290, 298 (4RM / 4WD)					
350, 352, 355, 360, 362, 365, 375, 375E, 390, 390E, 390T, 396, 398, 399 <i>Synchronisées / Synchronesh</i>	30/248-1 (1693833K92)				
362, 362N, 365, 372N, 375, 382N, 390, 390T, 396, 398, 399 <i>Synchronisées inverseur / Synchronesh shuttle</i>		30/249-2 (886089M1)	30/250-5 (1860867M5)	30/251-1 (886668M1)	30/252-2 (834303M1)
575, 590, 675, 690, 698, 698T, 699 (2RM / 2WD)	30/248-1 (1693833K92)				
575, 590, 675, 690, 698, 698T, 699 (4RM / 4WD) 592, 595, 1004, 1004T					
Séries 4200, 4300 Series 12 x 4 manuelle, 12 x 12 inverseur 12 x 4 manual, 12 x 12 shuttle					
Boîte 18 vitesses synchronisées / 18 speed synchronesh					
362N, 365, 372N, 375, 382N, 390, 390T, 398, 399					
4225, 4235, 4240, 4245, 4255, 4260, 4265, 4270, 4315, 4320, 4325, 4335, 4345, 4355, 4360, 4365, 4370 18 x 6 Speedshift		30/249-2 (886089M1)	30/250-5 (1860867M5)	30/251-1 (886668M1)	



Note : Voir pages MF-266 à MF-268 pour d'autres pièces de boîtes 12 vitesses synchronisées
Note : See pages MF-266 to MF-268 for other 12 speed synchronesh parts

Les références des pièces sont indicatives.
Nos pièces ne sont pas d'origine

Part numbers are quoted for reference purposes only.
Our parts and accessories are not original.



TRANSMISSION - ARBRES D'ENTREE
TRANSMISSION - INPUT SHAFTS

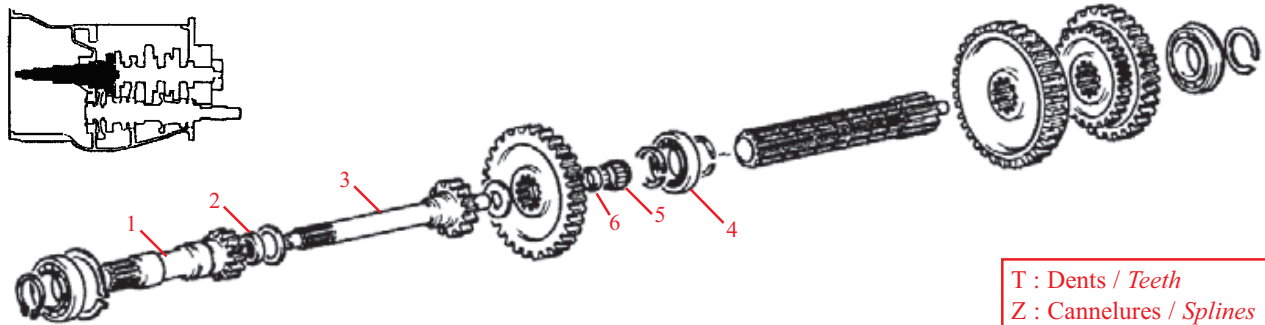

Fig.	1	2	3	4	5	6
Tracteurs Tractors	Arb. entr. PDF PTO input sh.	Bourrage Oil Seal	Arbre primaire Main drive	Roul. avant Mainsh. fr. bear.	Roulement Bearing	Entretoise Spacer
Boîte 6 vitesses prise constante / 6 speed constant mesh						
35, 65, 133, 135, 140, 145, 165, 175, 178, 240, 765, 865		30/256-1 (195501M1)		30/261-1 (195505M1)		
Boîte 8 vitesses prise constante (disque PDF 10 cannelures) / 8 speed constant mesh (10 spline PTO plate)						
133, 135, 140 (Étroit / Narrow)			18 T x 10 z 30/258-2 (964926M3)			
135	17 T 30/255-1 (906919M91)	30/256-2 (1860011M1)		30/261-2 (338552X1)	30/264-1 (2700273M1)	30/264-2 (2700274M2)
145			24 T x 10 z 30/258-1 (964925M3)			
148, 155, 158, 165, 168, 185, 188					30/264-1 (2700273M1)	30/264-2 (2700274M2)
Boîte 8 vitesses prise constante (disque PDF 25 cannelures) / 8 speed constant mesh (25 spline PTO plate)						
135	17 T 30/255-2 (1868531M1)		18 T x 10 z 30/258-2 (964926M3)			
148, 155, 158, 165, 168, 185, 188			24 T x 10 z 30/258-1 (964925M3)			
230	16 T 30/255-7 (1671705M1)					
235, 245, 250 (France)	17 T 30/255-2 (1868531M1)					
240	16 T 30/255-7 (1671705M1)	30/256-2 (1860011M1)	18 T x 10 z 30/258-2 (964926M3) 24 T x 10 z 30/258-1 (964925M3) 26 T x 10 z 30/258-11 (1862423M3)	30/261-2 (338552X1)	30/264-1 (2700273M1)	30/264-2 (2700274M2)
243						
253, 263			26 T x 10 z 30/258-11 (1862423M3)			

Les références des pièces sont indicatives.
Nos pièces ne sont pas d'origine

Part numbers are quoted for reference purposes only.
Our parts and accessories are not original.



TRANSMISSION - ARBRES D'ENTREE
TRANSMISSION - INPUT SHAFTS

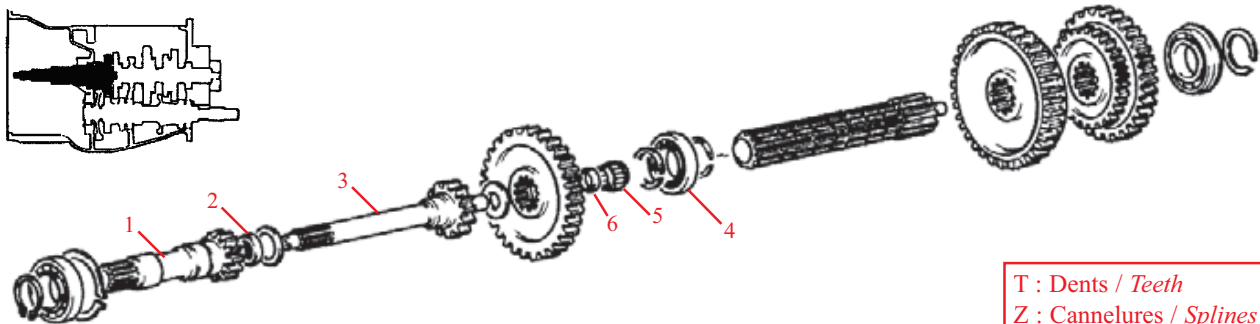

T : Dents / Teeth
Z : Cannelures / Splines

Fig.	1	2	3	4	5	6
Tracteurs Tractors	Arb. entr. PDF PTO input sh.	Bourrage Oil Seal	Arbre primaire Main drive	Roul. avant Mainsh. fr. bear.	Roulement Bearing	Entretoise Spacer
Boîte 8 vitesses prise constante (disque PDF 25 cannelures) / 8 speed constant mesh (25 spline PTO plate)						
250 (UK)	16 T 30/255-7 (1671705M1) 20 T 30/255-8 (1869712M91)	30/256-2 (1860011M1)	26 T x 10 z 30/258-11 (1862423M3)	30/261-2 (338552X1)	30/264-1 (2700273M1)	30/264-2 (2700274M2)
265, 275	17 T 30/255-2 (1868531M1) 20 T 30/255-8 (1869712M91)		24 T x 10 z 30/258-1 (964925M3) 26 T x 10 z 30/258-11 (1862423M3)			
275E, 375E	17 T 30/255-2 (1868531M1)		26 T x 10 z 30/258-11 (1862423M3) 6 x 21 z 30/258-17 (1693790M2)			
285			24 T x 10 z 30/258-1 (964925M3)			
290	17 T 30/255-2 (1868531M1) 16 T 30/255-7 (1671705M1) 20 T 30/255-8 (1869712M91)		25 T x 10 z 30/258-15 (908493M3) 26 T x 10 z 30/258-11 (1862423M3)			
290E, 390E	16 T 30/255-7 (1671705M1)		26 T x 10 z 30/258-11 (1862423M3) 6 x 21 z 30/258-17 (1693790M2)			
350, 355, 360, 362			6 x 21 z 30/258-17 (1693790M2)			

Les références des pièces sont indicatives.
Nos pièces ne sont pas d'origine

Part numbers are quoted for reference purposes only.
Our parts and accessories are not original.



TRANSMISSION - ARBRES D'ENTREE
TRANSMISSION - INPUT SHAFTS

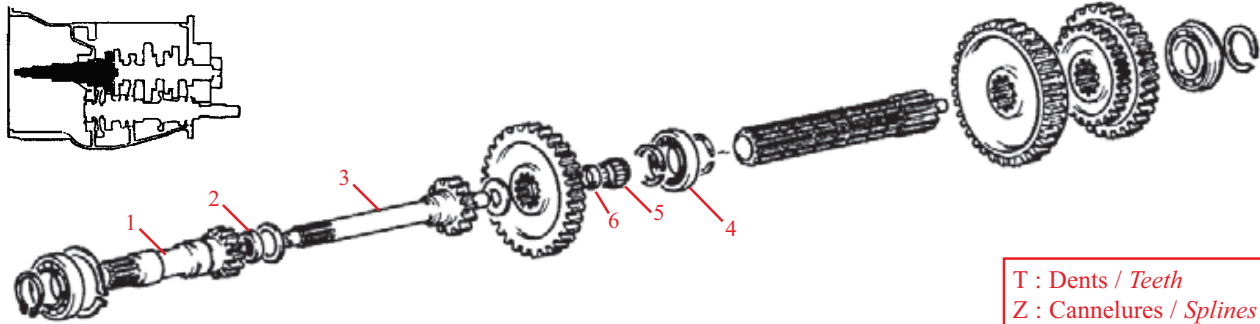

Fig.	1	2	3	4	5	6
Tracteurs Tractors	Arb. entr. PDF PTO input sh.	Bourrage Oil Seal	Arbre primaire Main drive	Roul. avant Mainsh. fr. bear.	Roulement Bearing	Entretoise Spacer
Boîte 8 vitesses prise constante (disque PDF 25 cannelures) / 8 speed constant mesh (25 spline PTO plate)						
365, 375, 390	16 T 30/255-7 (1671705M1) 20 T (⇒ B32999) 30/255-8 (1869712M91)		6 x 21 z 30/258-17 (1693790M2)			
390T	16 T 30/255-7 (1671705M1)					
550	17 T 30/255-2 (1868531M1) 20 T 30/255-8 (1869712M91)	30/256-2 (1860011M1)		30/261-2 (338552X1)	30/264-1 (2700273M1)	30/264-2 (2700274M2)
565, 575	17 T 30/255-2 (1868531M1)		24 T x 10 z 30/258-1 (964925M3) 26 T x 10 z 30/258-11 (1862423M3)			
590	17 T 30/255-2 (1868531M1) 16 T 30/255-7 (1671705M1) 20 T 30/255-8 (1869712M91)					
Boîte 8 vitesses synchronisées / 8 speed synchromesh						
133, 135, 140, 145	17 T 30/255-2 (1868531M1)	30/256-2 (1860011M1)	18 T x 10 z 30/258-2 (964926M3)	30/261-2 (338552X1)	30/264-1 (2700273M1)	30/264-2 (2700274M2)
135 MKIII, 148, 155	16 T 30/255-7 (ZF) (1671705M1)		24 T x 10 z 30/258-1 (964925M3)			

Les références des pièces sont indicatives.
Nos pièces ne sont pas d'origine

Part numbers are quoted for reference purposes only.
Our parts and accessories are not original.



"THE RELIABLE SERVICE"



TRANSMISSION - ARBRES D'ENTREE
TRANSMISSION - INPUT SHAFTS

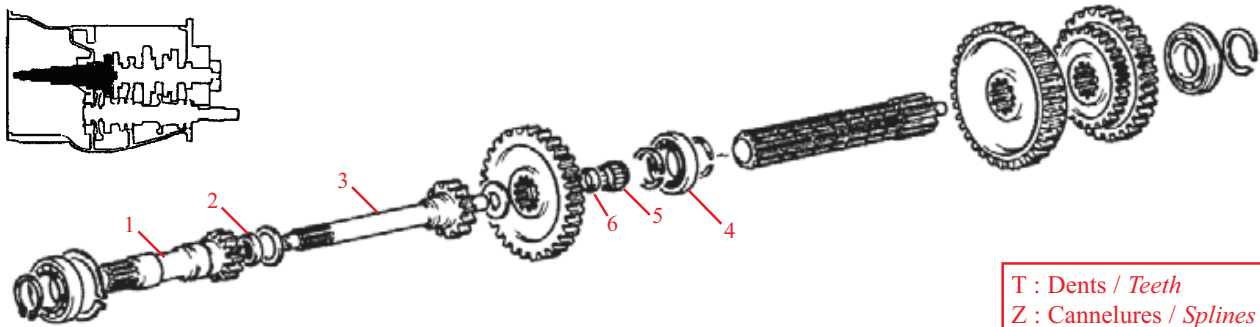

Fig.	1	2	3	4	5	6
Tracteurs Tractors	Arb. entr. PDF PTO input sh.	Bourrage Oil Seal	Arbre primaire Main drive	Roul. avant Mainsh. fr. bear.	Roulement Bearing	Entretoise Spacer
Boîte 8 vitesses synchronisées / 8 speed synchromesh						
152, 158, 168	17 T 30/255-2 (1868531M1) 16 T 30/255-7 (ZF) (1671705M1)		24 T x 10 z 30/258-1 (964925M3) 25 T x 10 z 30/258-15 (908493M3) 26 T x 10 z 30/258-11 (1862423M3)			
230	16 T 30/255-7 (1671705M1)					
240			18 T x 10 z 30/258-2 (964926M3)			
235	17 T 30/255-2 (1868531M1)					
245 250 (France)						
250 (UK) 253	16 T 30/255-7 (1671705M1)		24 T x 10 z 30/258-1 (964925M3) 26 T x 10 z 30/258-11 (1862423M3)			
255, 260, 265, 560 275, 285, 575 (2RM / 2WD) 675	17 T 30/255-2 (1868531M1)	30/256-2 (1860011M1)	25 T x 10 z 30/258-15 (908493M3)	30/261-2 (338552X1)	30/264-1 (2700273M1)	30/264-2 (2700274M2)
275, 285, 575 (4RM / 4WD)						
290, 590 (France)	20 T 30/255-8 (1869712M91)		26 T x 10 z 30/258-11 (1862423M3)			
290 (UK)	16 T 30/255-7 (1671705M1) 20 T 30/255-8 (1869712M91)		25 T x 10 z 30/258-15 (908493M3) 26 T x 10 z 30/258-11 (1862423M3)			
590 (UK)	17 T 30/255-2 (1868531M1) 20 T 30/255-8 (1869712M91)					
290E, 390E	16 T 30/255-7 (1671705M1)					
342						

Les références des pièces sont indicatives.
Nos pièces ne sont pas d'origine

Part numbers are quoted for reference purposes only.
Our parts and accessories are not original.



TRANSMISSION - ARBRES D'ENTREE
TRANSMISSION - INPUT SHAFTS

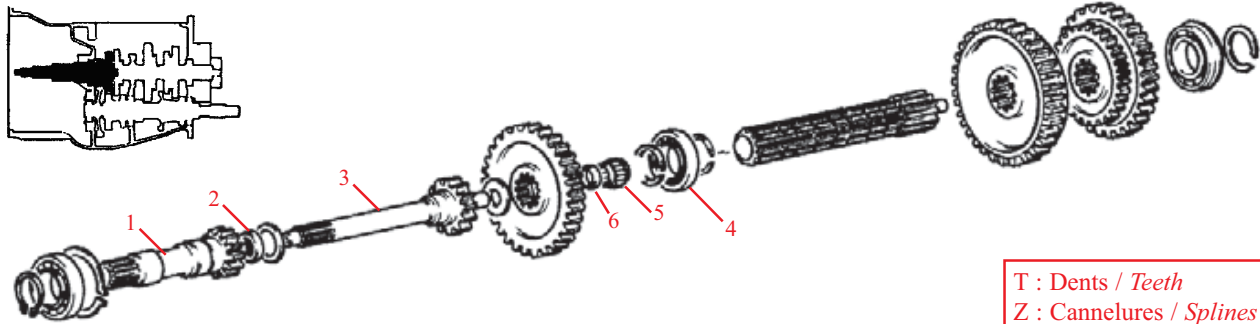

Fig.	1	2	3	4	5	6
Tracteurs Tractors	Arb. entr. PDF PTO input sh.	Bourrage Oil Seal	Arbre primaire Main drive	Roul. avant Mainsh. fr. bear.	Roulement Bearing	Entretoise Spacer
Boîte 8 vitesses synchronisées / 8 speed synchronesh						
350, 352, 355	16 T 30/255-7 (1671705M1)					
360, 365, 375, 390	16 T 30/255-7 (1671705M1) 20 T 30/255-8 (1869712M91)	30/256-2 (1860011M1)	6 x 21 z 30/258-17 (1693790M2)	30/261-2 (338552X1)	30/264-1 (2700273M1)	30/264-2 (2700274M2)
Boîte 8 x 2 Crash & 8 x 2 synchronisées / 8 x 2 Crash & 8 x 2 synchronesh						
4225, 4235, 4240, 4245, 4255, 4315, 4320, 4325, 4335, 4345, 4355		30/256-2 (1860011M1)	6 x 21 z 30/258-17 (1693790M2)	30/261-2 (338552X1)	30/264-1 (2700273M1)	30/264-2 (2700274M2)
Boîte 8 vitesses synchronisées inverseur / 8 speed synchronesh shuttle						
243, 253, 263			6 x 21 z 30/258-16 (1692502M2)			
340		Bour. / Oil seal 30/256-3 (883935M4)				
342, 350, 352		Roulem. / Bear. 30/251-2 (1677724M1)		30/261-2 (338552X1)	30/264-1 (2700273M1)	
355, 360, 362, 365, 375, 390, 390T	20 T (⇒ B32999) 30/255-9 (1677738M1)		6 x 21 z 30/258-16 (1692502M2)			
Boîte 8 x 8 inverseur / 8 x 8 shuttle						
4215, 4220, 4225, 4235, 4240, 4245, 4315, 4320, 4325, 4335, 4345		Bour. / Oil seal 30/256-3 (883935M4) Roulem. / Bear. 30/251-2 (1677724M1)	6 x 21 z 30/258-16 (1692502M2)	30/261-2 (338552X1)	30/264-1 (2700273M1)	
Boîte prise constante Multipower (disque PDF 10 cannelures) / Multipower constant mesh (10 spline PTO plate)						
35						
65, 765 (⇒ 609713)		30/256-3 (883935M4)		30/261-1 (195505M1)		
65, 765 (609714 ⇒)	17 T 30/255-3 (899332M92)		33 T x 10 z 30/258-4 (516523M92)		30/264-4 (834844M1)	

Les références des pièces sont indicatives.
Nos pièces ne sont pas d'origine

Part numbers are quoted for reference purposes only.
Our parts and accessories are not original.



TRANSMISSION - ARBRES D'ENTREE
TRANSMISSION - INPUT SHAFTS

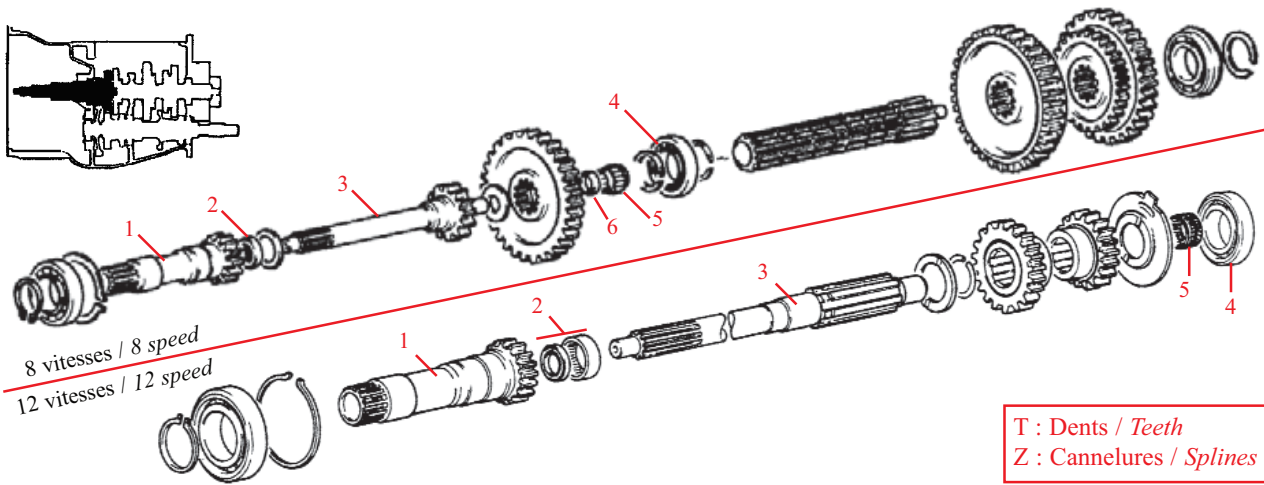

Fig.	1	2	3	4	5	6
Tracteurs Tractors	Arb. entr. PDF PTO input sh.	Bourrage Oil Seal	Arbre primaire Main drive	Roul. avant Mains. fr. bear.	Roulement Bearing	Entretoise Spacer
Boîte prise constante Multipower (disque PDF 10 cannelures) / Multipower constant mesh (10 spline PTO plate)						
133, 135, 140 (France)	17 T 30/255-3 (899332M92)	30/256-3 (883935M4)	33 T x 10 z 30/258-4 (516523M92)	30/261-1 (195505M1)	30/264-4 (834844M1)	
135, 148 (UK)						
145, 148 (France) 152, 155, 158, 165, 168, 175, 178, 185, 188						
Boîte prise constante Multipower (disque PDF 25 cannelures) / Multipower constant mesh (25 spline PTO plate)						
135, 148 (UK)	17 T 30/255-4 (1868528M92)	30/256-3 (883935M4)	33 T x 10 z 30/258-4 (516523M92)	30/261-1 (195505M1)	30/264-4 (834844M1)	
148 (France) 152, 155, 158, 165, 168, 185, 188						
235, 245 240						
250, 265 (France), 275 (France)	17 T 30/255-4 (1868528M92)	30/256-3 (883935M4)	33 T x 10 z 30/258-4 (516523M92)	30/261-1 (195505M1)	30/264-4 (834844M1)	
260, 265 (UK), 275 (UK)						
285, 290 550						
560, 565, 575, 590, 595, 675, 690, 1080, 1085			33 T x 10 z 30/258-4 (516523M92)			
1200						
Boîte synchronisée Multipower / Multipower synchronesh						
290, 365, 375, 390, 390T, 398, 399, 590, 595, 675, 690, 698, 698T, 699, 1200, 1250		30/256-3 (883935M4)		30/261-2 (338552X1)	30/264-1 (2700273M1)	
Boîte 12 vitesses synchronisées / 12 speed synchronesh						
158 MKIII, 168 MKIII, 253, 260, 265, 298		Bour. / Oil seal 30/256-3 (883935M4)				
275, 290	20 T 30/255-9 (1677738M1)	Roulem. / Bear: 30/251-2 (1677724M1)		30/261-2 (338552X1)	30/264-1 (2700273M1)	
275E, 290E, 350, 352, 375E, 390E			6 x 21 z 30/258-16 (1692502M2)			

Note : Voir pages MF-266 à MF-268 pour d'autres pièces de boîtes 12 vitesses synchronisées
Note : See pages MF-266 to MF-268 for other 12 speed synchronesh parts

Les références des pièces sont indicatives.
Nos pièces ne sont pas d'origine



"THE RELIABLE SERVICE"



Part numbers are quoted for reference purposes only.
Our parts and accessories are not original.

TRANSMISSION - ARBRES D'ENTREE
TRANSMISSION - INPUT SHAFTS

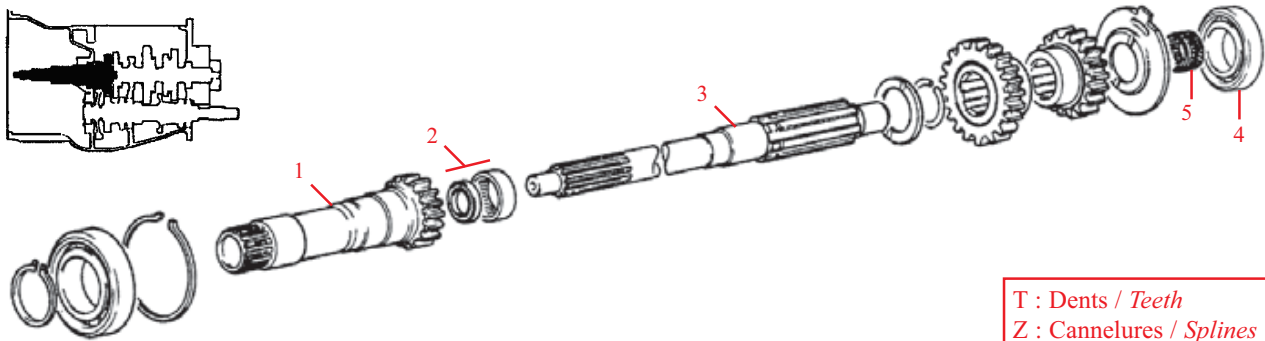

T : Dents / Teeth
Z : Cannelures / Splines

Fig.	1	2	3	4	5	6
Tracteurs Tractors	Arb. entr. PDF PTO input sh.	Bourrage Oil Seal	Arbre primaire Main drive	Roul. avant Mainsh. fr. bear.	Roulement Bearing	Entretoise Spacer
Boîte 12 vitesses synchronisées / 12 speed synchronesh						
355, 360, 362, 365, 375, 390, 390T, 396, 398, 399	20 T (⇒ B32999) 30/255-9 (1677738M1)	Bour. / Oil seal 30/256-3 (883935M4) Roulem. / Bear: 30/251-2 (1677724M1)	6 x 21 z 30/258-16 (1692502M2)	30/261-2 (338552X1)	30/264-1 (2700273M1)	
575, 595, 675, 698, 1004						
590, 690, 698T, 1004T	20 T 30/255-9 (1677738M1)					
699			6 x 21 z 30/258-16 (1692502M2)			
Boîte 12 vitesses synchronisées inverseur / 12 speed synchronesh shuttle						
362, 362N, 365, 372N, 375, 382N, 390, 390T, 396, 398, 399		Bour. / Oil seal 30/256-3 (883935M4) Roulem. / Bear: 30/251-2 (1677724M1)	6 x 21 z 30/258-16 (1692502M2)	30/261-2 (338552X1)	30/264-1 (2700273M1)	
Boîte 12 x 4 manuelle & 12 x 12 inverseur / 12 x 4 manual & 12 x 12 shuttle						
4215, 4220, 4225, 4235, 4240, 4245, 4255, 4260, 4265, 4270, 4315, 4320, 4325, 4335, 4345, 4355, 4360, 4365, 4370		Bour. / Oil seal 30/256-3 (883935M4) Roulem. / Bear: 30/251-2 (1677724M1)	6 x 21 z 30/258-16 (1692502M2)	30/261-2 (338552X1)	30/264-1 (2700273M1)	
Boîte 18 vitesses synchronisées / 18 speed synchronesh						
362N, 365, 372N, 382N, 390, 390T, 398, 399		Bour. / Oil seal 30/256-3 (883935M4) Roulem. / Bear: 30/251-2 (1677724M1)		30/261-2 (338552X1)	30/264-1 (2700273M1)	
Boîte 18 x 6 Speedshift / 18 x 6 Speedshift						
4225, 4235, 4240, 4245, 4255, 4260, 4265, 4270, 4325, 4335, 4345, 4355, 4360, 4365, 4370		Bour. / Oil seal 30/256-3 (883935M4) Roulem. / Bear: 30/251-2 (1677724M1)		30/261-2 (338552X1)	30/264-1 (2700273M1)	

 **Note : Voir pages MF-266 à MF-268 pour d'autres pièces de boîtes 12 vitesses synchronisées**
Note : See pages MF-266 to MF-268 for other 12 speed synchronesh parts

Les références des pièces sont indicatives.
Nos pièces ne sont pas d'origine

Part numbers are quoted for reference purposes only.
Our parts and accessories are not original.



TRANSMISSION - ARBRES PRIMAIRES
TRANSMISSION - MAINSHAFTS

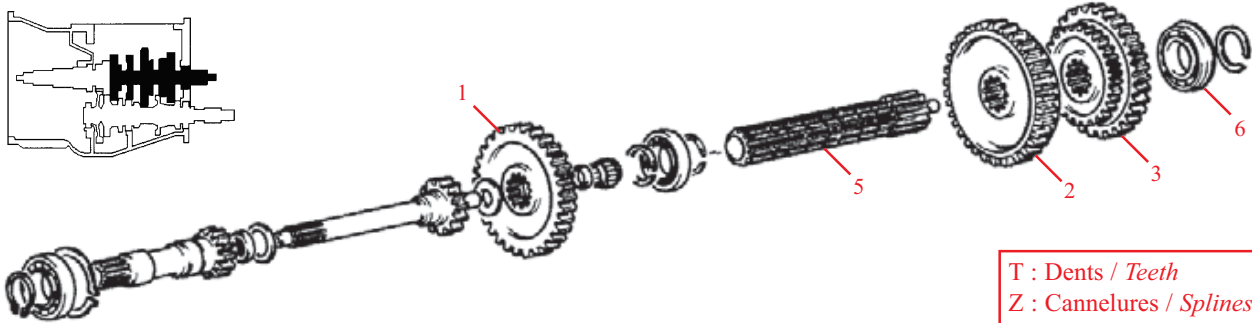

Fig.	1	2	3	4	5	6
Tracteurs Tractors	Pignon Gear	Pignon Gear	Pignon Gear	Pignon Gear	Arbre primaire Mainshaft	Roul. arrière Rear bearing
Boîte 6 vitesses prise constante 6 speed constant mesh		1 ^{ère} & Arrière 1 st & Reverse	2 ^{ème} & 3 ^{ème} 2 nd & 3 rd			
35 (⇒ 213313) 65, 765 (⇒ 531318)			46/36 T 30/263-1 (180416M1)		30/265-1 (180441M1)	30/266-1 (3008252X1)
35 (213314 ⇒) 65, 765 (531319 ⇒)		44 T 30/262-2 (1682688M1)	46/36 T 30/263-2 (880957M1)			
133, 135, 140, 145, 165, 175, 178, 240					30/265-2 (880955M2)	
Boîte 8 vitesses prise constante 8 speed constant mesh	3 ^{ème} 3 rd	1 ^{ère} & Arrière 1 st & Reverse	2 ^{ème} & 4 ^{ème} 2 nd & 4 th			
133, 135, 140, 145, 152 (France)	41 T 30/259-1 (1682690M1)	44 T 30/262-2 (1682688M1)			30/265-2 (880955M2)	30/266-1 (3008252X1)
135, 148, 155, 158, 165, 168, 185, 188, 235, 240, 250, 265 (Premiers / Early) Réducteur épicycloïdal standard Standard epicyclic unit			46/36 T 30/263-2 (880957M1)		30/265-4 (A) (1870149M2)	
135, 148, 155, 158, 165, 168, 185, 188, 235, 240, 250, 265 (Derniers / Late) Réducteur épicycloïdal standard Standard epicyclic unit			46/36 T 30/263-5 (1682691M1)		30/265-8 (1687643M1)	
148, 165, 168, 185, 188 (Premiers / Early) Réducteur épicycloïdal renforcé Heavy duty epicyclic unit			46/36 T 30/263-2 (880957M1)		30/265-3 (B) (1870151M2)	
148, 165, 168, 185, 188 (Derniers / Late) Réducteur épicycloïdal renforcé Heavy duty epicyclic unit			46/36 T 30/263-5 (1682691M1)		30/265-7 (1687642M1)	
265, 275, 275E, 290, 290E, 362, 365, 375, 375E, 390, 390E 390T, 396						
550, 565, 575, 590	41 T 30/259-1 (1682690M1)		46/36 T 30/263-2 (880957M1)		30/265-3 (B) (1870151M2)	

(A) L'arbre 30/265-4 (1870149M2) peut-être remplacé par l'arbre 30/265-8 (1687643M1) + pignon 30/263-5 (1682691M1)
 (A) Shaft 30/265-4 (1870149M2) may be replaced by shaft 30/265-8 (1687643M1) plus gear 30/263-5 (1682691M1)
 (B) L'arbre 30/265-3 (1870151M2) peut-être remplacé par l'arbre 30/265-7 (1687642M1) + pignon 30/263-5 (1682691M1)
 (B) Shaft 30/265-3 (1870151M2) may be replaced by shaft 30/265-7 (1687642M1) plus gear 30/263-5 (1682691M1)

Les références des pièces sont indicatives.
Nos pièces ne sont pas d'origine

Part numbers are quoted for reference purposes only.
Our parts and accessories are not original.



"THE RELIABLE SERVICE"



TRANSMISSION - ARBRES PRIMAIRES
TRANSMISSION - MAINSHAFTS

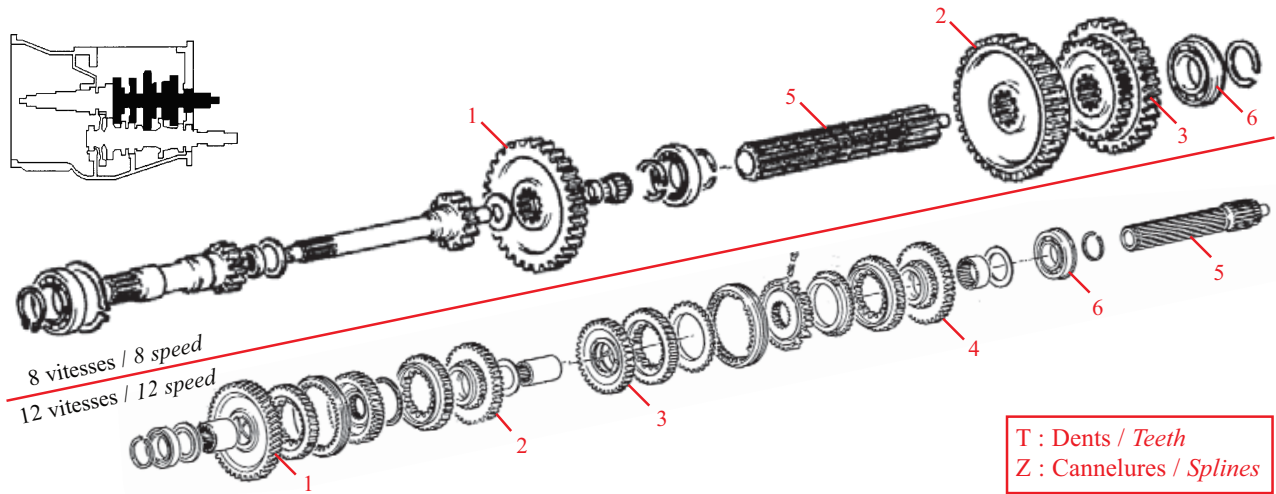

Fig.	1	2	3	4	5	6
Tracteurs Tractors	Pignon Gear	Pignon Gear	Pignon Gear	Pignon Gear	Arbre primaire Mainshaft	Roul. arrière Rear bearing
Boîte 8 x 2 crash / 8 x 2 crash						
4225, 4235, 4240, 4245, 4255, 4325, 4335, 4345, 4355	41 T 30/259-1 (1682690M1)	44 T 30/262-2 (1682688M1)	46/36 T 30/263-5 (1682691M1)		30/265-7 (1687642M1)	30/266-1 (3008252X1)
Boîte 8 vitesses synchronisées 8 speed synchromesh						
	2 ^{ème} 2 nd	1 ^{ère} & Arrière 1 st & Reverse	4 ^{ème} 4 th	3 ^{ème} 3 rd		
133, 135, 140, 145, 148, 152, 155, 158, 168, 230, 235, 240, 245, 250, 253, 255, 260, 265, 275, 285, 290, 290E, 340, 342, 350, 352, 355, 360, 362, 365, 375, 390, 390E, 390T, 560, 575, 590, 675		44 T 30/262-2 (1682688M1)				30/266-1 (3008252X1)
Boîte 8 x 2 synchronisées / 8 x 2 synchromesh						
4225, 4235, 4240, 4245, 4255, 4325, 4335, 4345, 4355		44 T 30/262-2 (1682688M1)				30/266-1 (3008252X1)
Boîte prise constante Multipower Multipower constant mesh						
		1 ^{ère} & Arrière 1 st & Reverse	2 ^{ème} & 3 ^{ème} 2 nd & 3 rd			
35, 65, 133, 135, 140, 145, 148, 152, 155, 158, 165, 168, 175, 178, 185, 188, 235, 240, 245, 250, 260, 265, 275, 285, 290, 550, 560, 575, 590, 595, 675, 765, 1080, 1085, 1200		44 T 30/262-2 (1682688M1)	46/36 T 30/263-2 (880957M1)			30/266-1 (3008252X1)
Boîte 12 vitesses synchronisées 12 speed synchromesh						
	1 ^{ère} 1 st	Arrière Reverse	3 ^{ème} 3 rd	2 ^{ème} 2 nd		
253, 265, 350, 352, 355, 360, 362, 365, 375 Réducteur épicycloïdal standard Standard epicyclic unit						
265, 355, 360, 362, 365, 375 Réducteur épicycloïdal renforcé Heavy duty epicyclic unit	42 T 30/262-10 (1686467M91)	44 T 30/285-7 (1686468M91)	36 T 30/259-10 (1686028M91)	40 T 30/263-11 (1687429M91)	30/265-19 (1662224M2)	30/266-1 (3008252X1)
158 MKIII, 168 MKIII, 275, 275E, 290, 290E, 298, 375, 375E, 390, 390E, 390T, 396, 398, 399, 675, 690, 698T, 699, 1004T						
Boîtes 12 vitesses Multipower / 12 speed Multipower						
365	42 T 30/262-10 (1686467M91)	44 T 30/285-7 (1686468M91)	36 T 30/259-10 (1686028M91)	40 T 30/263-11 (1687429M91)	30/265-19 (1662224M2)	30/266-1 (3008252X1)
375, 390, 390T, 398, 399						
Boîte manuelle 12 x 4 / 12 x 4 manual						
4215, 4220, 4225, 4235, 4240, 4245, 4255, 4260, 4270 (⇒ J08010)	42 T 30/262-10 (1686467M91)	44 T 30/285-7 (1686468M91)	36 T 30/259-10 (1686028M91)	40 T 30/263-11 (1687429M91)	30/265-19 (1662224M2)	30/266-1 (3008252X1)

Les références des pièces sont indicatives.
Nos pièces ne sont pas d'origine

Part numbers are quoted for reference purposes only.
Our parts and accessories are not original.



"THE RELIABLE SERVICE"



TRANSMISSION - REDUCTEURS EPICYCLOIDAUX
TRANSMISSION - EPICYCLIC UNITS

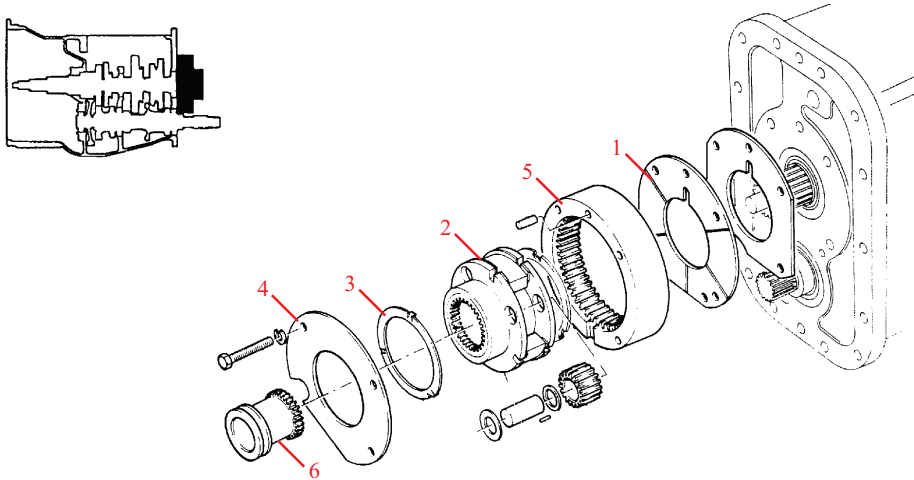

Fig.	1	2	3	4	5	6
Tracteurs Tractors	Plaque avant Front cover	Porte satellites Carrier unit	Rondelle Thrust washer	Plaque arrière Rear cover	Couronne Annular gear	Accouplement Coupler
Standard / Standard duty						
35 (⇒ 383154), 835 65, 765 (⇒ 609713), 865	30/267-1 (180408M2)	30/268-1 (827719M91)	30/269-1 (180414M1)	30/270-1 (184012M4)		30/273-1 (184770M3)
35 (383155 ⇒) 65, 765 (609714 ⇒)		30/268-2 (897711M93)	30/269-2 (897367M1)			
133, 135, 140, 145, 152, 155, 158, 165		30/268-3 (1808974M92)	30/269-3 (518414M1)			
148, 168, 175, 178, 185, 188		30/268-2 (897711M93)	30/269-2 (897367M1)			
230, 235, 240, 243, 245, 250, 253, 255, 260, 265, 275		30/268-3 (1808974M92)	30/269-3 (518414M1)			
340, 342, 350, 352, 355, 360, 362, 375						
550, 560						
1080, 1085						
Renforcé / Heavy duty						
148, 152, 168, 185, 188	30/267-2 (1867425M1)	30/268-4 (1870538M93)	30/269-4 (1866545M2)	30/270-2 (1867423M1)	30/271-2 (1867424M2)	30/273-2 (1866557M2)
235, 245, 250, 260, 265, 275, 275E, 285, 290, 290E, 298						
362, 375, 375E, 390, 390E, 390T, 396, 398, 399						
550, 565, 575, 590, 592, 595, 675, 690, 1200, 1250						
4215, 4220, 4225, 4235, 4240, 4245, 4255, 4260, 4265, 4270, 4315, 4320, 4325, 4335, 4345, 4355, 4360, 4365, 4370						

Les références des pièces sont indicatives.
Nos pièces ne sont pas d'origine

Part numbers are quoted for reference purposes only.
Our parts and accessories are not original.



TRANSMISSION - ARBRES DE PRISE DE FORCE
TRANSMISSION - PTO DRIVE SHAFTS

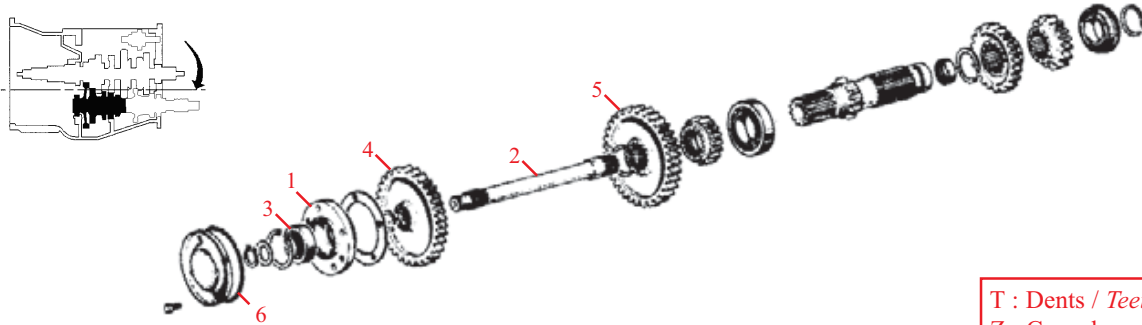

T : Dents / Teeth
Z : Cannelures / Splines

Fig.	1	2	3	4	5	6		
Tracteurs Tractors	Roul. PTO PTO bearing	Arbre pr. PDF PTO drive sh.	Roul. avant Front bearing	Pignon PDF PTO gear	Pignon primaire Main drive gear	Joint Gasket		
Boîte 6 vitesses prise constante / 6 speed constant mesh								
65, 765 (609714 ⇔) 133, 140, 145, 175, 178	30/245-2 (899331M1)	30/246-2 (1868533M1)	30/292-1 (899377M2)	53 T 30/293-1 (1868532M1)		Joint / Gasket 30/306-6 (181237M1)		
135, 165						"O" Ring 30/306-2 (1004633M1)		
240								
Boîte 8 vitesses prise constante / 8 speed constant mesh								
133, 135, 140, 145, 152 (France)	30/245-2 (899331M1)	30/246-2 (1868533M1)	30/292-1 (899377M2)	53 T 30/293-1 (1868532M1)	50 T 30/294-2 (906468M1)	Joint / Gasket 30/306-6 (181237M1) "O" Ring 30/306-2 (1004633M1)		
135 (UK)					45 T 30/294-1 (906469M1)			
148								
155, 158, 165, 168, 185, 188								
230								
240					406mm/16.00" 30/246-2 (1868533M1) ou / or 557mm/21.95" 30/246-6 (1869279M1)		50 T 30/294-2 (906468M1) 45 T 30/294-1 (906469M1)	
235, 245					30/246-2 (1868533M1)		53 T 30/293-1 (1868532M1)	
250							38 T 30/293-3 (1869708M1)	
243, 253, 263					406mm/16.00" 30/246-2 (1868533M1) ou / or 557mm/21.95" 30/246-6 (1869279M1)			
265, 275, 285					30/246-6 (1869279M1)		53 T 30/293-1 (1868532M1)	45 T 30/294-1 (906469M1)

Les références des pièces sont indicatives.
Nos pièces ne sont pas d'origine

Part numbers are quoted for reference purposes only.
Our parts and accessories are not original.



"THE RELIABLE SERVICE"



TRANSMISSION - ARBRES DE PRISE DE FORCE
TRANSMISSION - PTO DRIVE SHAFTS

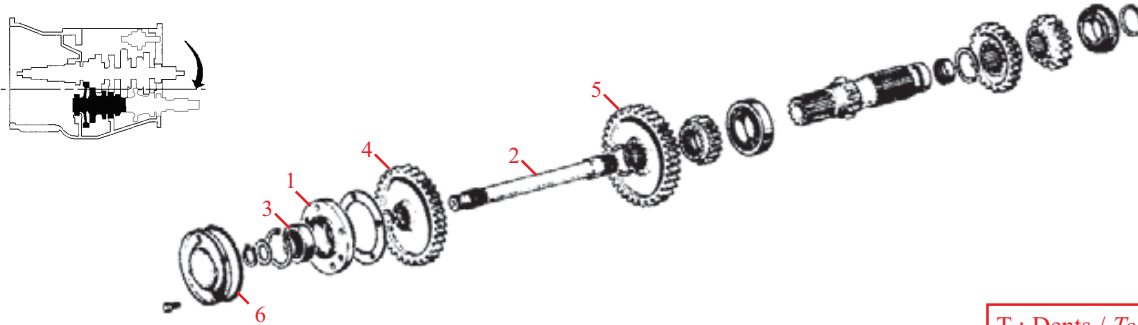

T : Dents / Teeth
Z : Cannelures / Splines

Fig.	1	2	3	4	5	6		
Tracteurs Tractors	Roul. PTO PTO bearing	Arbre pr. PDF PTO drive sh.	Roul. avant Front bearing	Pignon PDF PTO gear	Pignon primaire Main drive gear	Joint Gasket		
Boîte 8 vitesses prise constante / 8 speed constant mesh								
290	30/245-2 (899331M1)	406mm/16.00" 30/246-2 (1868533M1) ou / or 557mm/21.95" 30/246-6 (1869279M1)	30/292-1 (899377M2)	38 T 30/293-3 (1869708M1)		Joint / Gasket 30/306-6 (181237M1) "O" Ring 30/306-2 (1004633M1)		
350, 355, 360, 362								
365, 375, 390, 390T, 396			30/292-2 (3760514M1)	38 T (⇒ B32999) 30/293-3 (1869708M1)				
550				53 T 30/293-1 (1868532M1)	45 T 30/294-1 (906469M1)			
565, 575			30/246-2 (1868533M1)	30/292-1 (899377M2)	38 T 30/293-3 (1869708M1)			
590								
Boîte 8 x 2 crash / 8 x 2 crash								
4225, 4235, 4240, 4245, 4255, 4325, 4335, 4345, 4355	30/245-2 (899331M1)		30/292-2 (3760514M1)		45 T (USA) 30/294-1 (906469M1)	30/306-2 (1004633M1)		
Boîte 8 vitesses synchronisées / 8 speed synchromesh								
133, 135, 140, 145, 148	30/245-2 (899331M1)	30/246-2 (1868533M1)	30/292-1 (899377M2)	53 T 30/293-1 (1868532M1)	50 T 30/294-2 (906468M1)	Joint / Gasket 30/306-6 (181237M1) "O" Ring 30/306-2 (1004633M1)		
135, 148 (ZF)								
152, 155, 158, 168					53 T 30/293-1 (1868532M1)		45 T 30/294-1 (906469M1)	
230								
235, 245				406mm/16.00" 30/246-2 (1868533M1) ou / or 557mm/21.95" 30/246-6 (1869279M1)			53 T 30/293-1 (1868532M1)	50 T 30/294-2 (906468M1)
240								
250, 255							38 T 30/293-3 (1869708M1)	45 T 30/294-1 (906469M1)
253								
260, 265, 275, 285							53 T 30/293-1 (1868532M1)	45 T 30/294-1 (906469M1)
290							38 T 30/293-3 (1869708M1)	

Les références des pièces sont indicatives.
Nos pièces ne sont pas d'origine

Part numbers are quoted for reference purposes only.
Our parts and accessories are not original.



"THE RELIABLE SERVICE"



TRANSMISSION - ARBRES DE PRISE DE FORCE
TRANSMISSION - PTO DRIVE SHAFTS

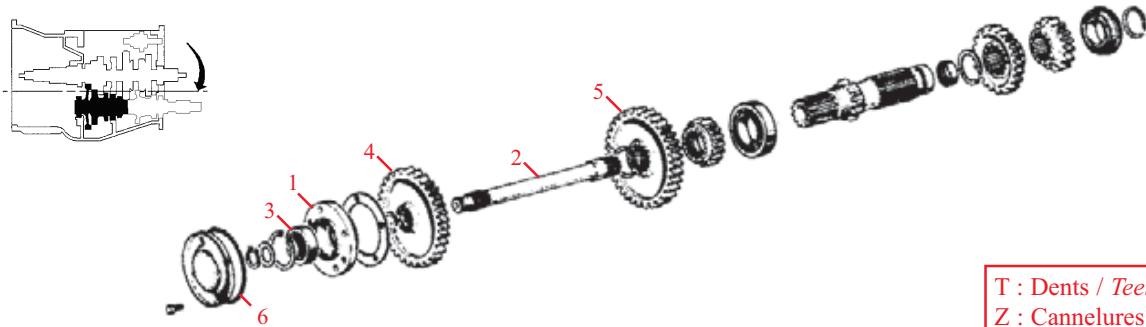

T : Dents / Teeth
Z : Cannelures / Splines

Fig.	1	2	3	4	5	6
Tracteurs Tractors	Roul. PTO PTO bearing	Arbre pr. PDF PTO drive sh.	Roul. avant Front bearing	Pignon PDF PTO gear	Pignon primaire Main drive gear	Joint Gasket
Boîte 8 vitesses synchronisées / 8 speed synchronesh						
290E, 390E	30/245-2 (899331M1)	30/246-6 (1869279M1)	30/292-1 (899377M2)			Joint / Gasket 30/306-6 (181237M1) "O" Ring 30/306-2 (1004633M1)
340, 342, 352			30/292-2 (3760514M1)	38 T 30/293-3 (1869708M1)		
350						
355, 360, 362, 365, 375, 390		406mm/16.00" 30/246-2 (1868533M1) ou / or 557mm/21.95" 30/246-6 (1869279M1)	30/292-1 (899377M2)	53 T 30/293-1 (1868532M1)	45 T 30/294-1 (906469M1)	
560, 575, 675						
590			38 T 30/293-3 (1869708M1)			
Boîte 8 x 2 synchronisées / 8 x 2 synchronesh						
4225, 4235, 4240, 4245, 4255, 4325, 4335, 4345, 4355	30/245-2 (899331M1)		30/292-2 (3760514M1)			30/306-2 (1004633M1)
Boîte 8 vitesses synchronisées inverseur / 8 speed synchronesh shuttle						
243, 253, 263	30/245-2 (899331M1)	406mm/16.00" 30/246-2 (1868533M1) ou / or 557mm/21.95" 30/246-6 (1869279M1)	30/292-1 (899377M2)			30/306-2 (1004633M1)
340, 342, 352		30/246-6 (1869279M1)				
350, 355, 362, 365, 375, 390, 390T		406mm/16.00" 30/246-2 (1868533M1) ou / or 557mm/21.95" 30/246-6 (1869279M1)	30/292-2 (3760514M1)	38 T (⇒ B32999) 30/293-3 (1869708M1)		
Boîte 8 vitesses inverseur / 8 x 8 shuttle						
4215, 4220, 4225, 4235, 4240, 4245, 4320, 4325, 4335, 4345	30/245-2 (899331M1)		30/292-2 (3760514M1)			30/306-2 (1004633M1)

Les références des pièces sont indicatives.
Nos pièces ne sont pas d'origine

Part numbers are quoted for reference purposes only.
Our parts and accessories are not original.



"THE RELIABLE SERVICE"



TRANSMISSION - ARBRES DE PRISE DE FORCE
TRANSMISSION - PTO DRIVE SHAFTS

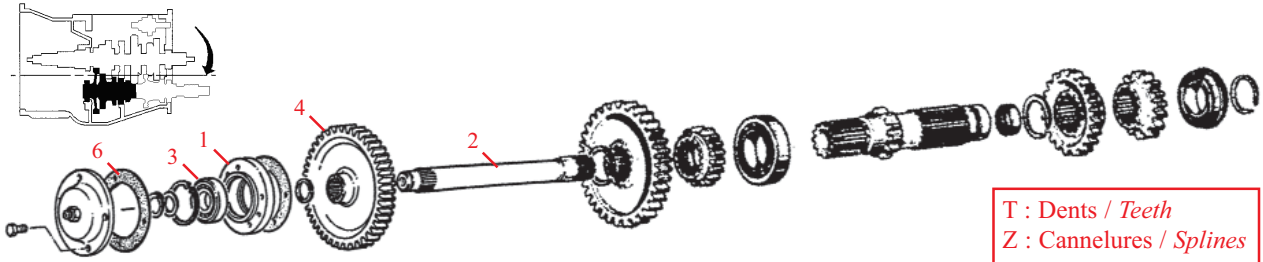

Fig.	1	2	3	4	5	6			
Tracteurs Tractors	Roul. PTO PTO bearing	Arbre pr. PDF PTO drive sh.	Roul. avant Front bearing	Pignon PDF PTO gear	Pignon primaire Main drive gear	Joint Gasket			
Boîte prise constante et synchronisée Multipower / Multipower constant mesh & synchromesh									
65, 765 (609714 ⇒) 133, 135, 140, 145, 155 (France) 175, 178	30/245-2 (899331M1)	30/246-2 (1868533M1)	30/292-1 (899377M2)	53 T 30/293-1 (1868532M1)		Joint / Gasket 30/306-6 (181237M1)			
135, 148, 152, 158, 165, 168, 185, 188									
235, 245, 260, 265, 275 240, 285									
250, 290		406mm/16.00" 30/246-2 (1868533M1) ou / or 557mm/21.95" 30/246-6 (1869279M1)	30/292-2 (3760514M1)	38 T 30/293-3 (1869708M1)					
365, 375, 390, 398, 399 390T									
550		30/246-2 (1868533M1)	30/292-1 (899377M2)	38 T 30/293-3 (1869708M1)			"O" Ring 30/306-2 (1004633M1)		
560, 565, 575, 595, 675, 698		406mm/16.00" 30/246-2 (1868533M1) ou / or 557mm/21.95" 30/246-6 (1869279M1)							
590, 690		30/246-6 (1869279M1)						38 T 30/293-3 (1869708M1)	
698T, 699 1080, 1085, 1200, 1250		30/246-6 (1869279M1)							
Boîte 12 vitesses synchronisées / 12 speed synchromesh									
158 MKIII, 168 MKIII		30/245-2 (899331M1)	30/246-6 (1869279M1)	30/292-1 (899377M2)	53 T 30/293-1 (1868532M1)			Joint / Gasket 30/306-6 (181237M1)	
253			406mm/16.00" 30/246-2 (1868533M1) ou / or 557mm/21.95" 30/246-6 (1869279M1)		53 T 30/293-1 (1868532M1)				
265, 275	30/246-6 (1869279M1)								

Note : Voir pages MF-266 à MF-268 pour d'autres pièces de boîtes 12 vitesses synchronisées
Note : See pages MF-266 to MF-268 for other 12 speed synchromesh parts

Les références des pièces sont indicatives.
Nos pièces ne sont pas d'origine

Part numbers are quoted for reference purposes only.
Our parts and accessories are not original.



TRANSMISSION - ARBRES DE PRISE DE FORCE
TRANSMISSION - PTO DRIVE SHAFTS

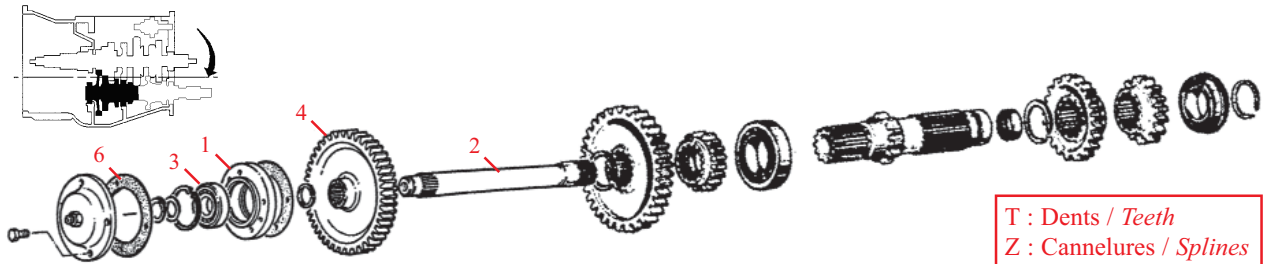



Fig.	1	2	3	4	5	6	
Tracteurs Tractors	Roul. PTO PTO bearing	Arbre pr. PDF PTO drive sh.	Roul. avant Front bearing	Pignon PDF PTO gear	Pignon primaire Main drive gear	Joint Gasket	
Boîte 12 vitesses synchronisées / 12 speed synchronesh							
275E, 375E	30/245-2 (899331M1)	30/246-6 (1869279M1)	30/292-1 (899377M2)	53 T 30/293-1 (1868532M1)		Joint / Gasket 30/306-6 (181237M1) "O" Ring 30/306-2 (1004633M1)	
290E, 390E		406mm/16.00" 30/246-2 (1868533M1) ou / or 557mm/21.95" 30/246-6 (1869279M1)		30/292-1 (899377M2)			53 T 30/293-1 (1868532M1)
290							30/292-1 (899377M2)
298							
350, 352		30/246-6 (1869279M1)	30/292-2 (3760514M1)				
355, 360, 362, 365, 375, 390, 398		406mm/16.00" 30/246-2 (1868533M1) ou / or 557mm/21.95" 30/246-6 (1869279M1)		38 T (⇒ B32999) 30/293-3 (1869708M1)			
396, 399		30/246-6 (1869279M1)					
575, 675		406mm/16.00" 30/246-2 (1868533M1) ou / or 557mm/21.95" 30/246-6 (1869279M1)	30/292-1 (899377M2)	53 T 30/293-1 (1868532M1)			
590, 690		30/246-6 (1869279M1)		38 T 30/293-3 (1869708M1)			
592, 595							
698, 1004							
698T, 699, 1004T		30/246-6 (1869279M1)		38 T 30/293-3 (1869708M1)			
Boîte 12 vitesses synchronisées inverseur / 12 speed synchronesh shuttle							
362, 362N, 365, 372N, 375, 382N, 390, 390T, 396, 398, 399	30/245-2 (899331M1)		30/292-2 (3760514M1)			30/306-2 (1004633M1)	

 **Note : Voir pages MF-266 à MF-268 pour d'autres pièces de boîtes 12 vitesses synchronisées**
Note : See pages MF-266 to MF-268 for other 12 speed synchronesh parts

Les références des pièces sont indicatives.
Nos pièces ne sont pas d'origine

Part numbers are quoted for reference purposes only.
Our parts and accessories are not original.



TRANSMISSION - ARBRES DE PRISE DE FORCE
TRANSMISSION - PTO DRIVE SHAFTS

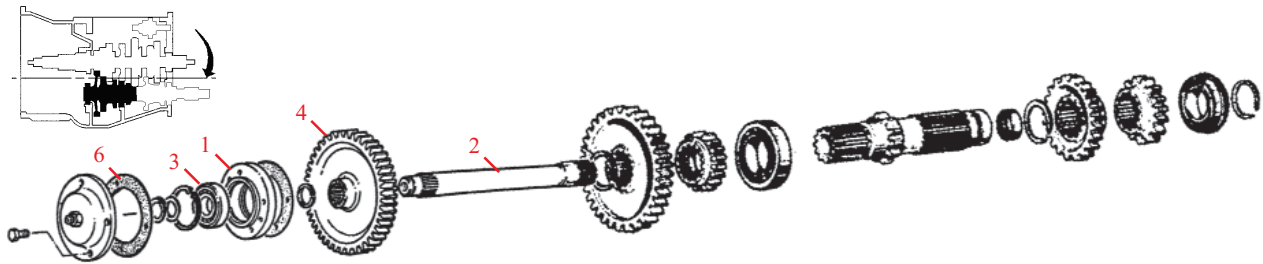

Fig.	1	2	3	4	5	6
Tracteurs Tractors	Roul. PTO PTO bearing	Arbre pr. PDF PTO drive sh.	Roul. avant Front bearing	Pignon PDF PTO gear	Pignon primaire Main drive gear	Joint Gasket
Boîte 12 x 4 manuelle & 12 x 12 inverseur / 12 x 4 manual & 12 x 12 shuttle						
4215, 4220, 4225, 4235, 4240, 4245, 4255, 4260, 4265, 4270, 4315, 4320, 4325, 4335, 4345, 4355, 4360, 4365, 4370	30/245-2 (899331M1)		30/292-2 (3760514M1)			30/306-2 (1004633M1)
Boîte 18 vitesses synchronisées / 18 speed synchronesh						
362N, 365, 372N, 382N, 390, 390T, 398, 399	30/245-2 (899331M1)		30/292-2 (3760514M1)			30/306-2 (1004633M1)
Boîte 18 x 6 Speedshift / 18 x 6 Speedshift						
4225, 4235, 4240, 4245, 4255, 4260, 4265, 4270, 4325, 4335, 4345, 4355, 4360, 4365, 4370	30/245-2 (899331M1)		30/292-2 (3760514M1)			30/306-2 (1004633M1)



Note : Voir pages MF-266 à MF-268 pour d'autres pièces de boîtes 12 vitesses synchronisées
Note : See pages MF-266 to MF-268 for other 12 speed synchronesh parts

Les références des pièces sont indicatives.
Nos pièces ne sont pas d'origine

*Part numbers are quoted for reference purposes only.
Our parts and accessories are not original.*



TRANSMISSION - ARBRES DE RENVOI
TRANSMISSION - COUNTERSHAFTS

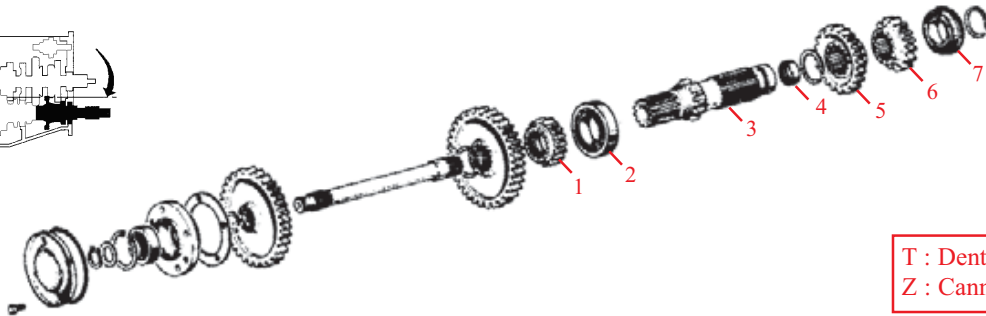
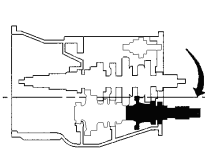

T : Dents / Teeth
Z : Cannelures / Splines

Fig.	1	2	3	4	5	6	7
Tracteurs Tractors	Pignon Pinion	Roulement Bearing	Arbre renvoi Countershaft	Roul. aiguille Needle bear.	Pignon Pinion	Pignon Pinion	Roulement Bearing
Boîte 6 vitesses prise constante <i>6 speed constant mesh</i>					3 ^{ème} 3 rd	2 ^{ème} 2 nd	
35, 65, 133, 135, 140, 145, 165, 175, 178, 240, 765, 865, 1080		30/277-1 (195507M1)	Embr. double <i>Dual clutch</i> 30/278-1 (183054M92)	30/302-1 (195453M1)	33 T 30/280-1 (180415M1)	23 T 30/281-1 (180419M1)	30/266-1 (3008252X1)
Boîte 8 vitesses prise constante <i>8 speed constant mesh</i>					4 ^{ème} 4 th	2 ^{ème} 2 nd	
133, 135, 140, 145, 148, 152, 155, 158, 165, 185, 188, 230, 235, 240, 245, 250, 253, 265, 275, 275E, 285, 290, 290E	28 T 30/276-1 (964916M1)						
243							
350, 355, 360, 362, 365, 375, 375E, 390, 390E	28 T 30/276-1 (964916M1)	30/277-1 (195507M1)	30/278-2 (906472M2)	30/302-1 (195453M1)	33 T 30/280-1 (180415M1)	23 T 30/281-1 (180419M1)	30/266-1 (3008252X1)
390T, 396							
550, 565, 575, 590	28 T 30/276-1 (964916M1)						
Boîte 8 x 2 crash / 8 x 2 crash							
4225, 4235, 4240, 4245, 4255, 4325, 4335, 4345, 4355	28 T 30/276-1 (964916M1)	30/277-1 (195507M1)	30/278-2 (906472M2)	30/302-1 (195453M1)	33 T 30/280-1 (180415M1)	23 T 30/281-1 (180419M1)	30/266-1 (3008252X1)
Boîte 8 vitesses synchronisées / 8 speed synchromesh							
133, 135, 140, 145, 148, 152, 155, 158, 168, 230, 235, 240, 245, 250, 253, 255, 260, 265, 275, 290, 290E, 340, 342, 350, 352, 355, 360, 362, 365, 375, 390, 390E, 560, 575, 590, 675		30/277-1 (195507M1)	30/278-2 (906472M2)	30/302-1 (195453M1)			30/266-1 (3008252X1)
Boîte 8 x 2 synchronisées / 8 x 2 synchromesh							
4225, 4235, 4240, 4245, 4255, 4325, 4335, 4345, 4355		30/277-1 (195507M1)	30/278-2 (906472M2)	30/302-1 (195453M1)			30/266-1 (3008252X1)
Boîte Multipower prise constante <i>Multipower constant mesh</i>					3 ^{ème} 3 rd	2 ^{ème} 2 nd	
35, 65, 133, 135, 140, 145, 148, 152, 155, 158, 165, 168, 175, 178, 185, 188, 235, 240, 245, 250, 260, 265, 275, 285, 290, 550, 560, 575, 590, 595, 675, 765, 1080, 1085, 1200		30/277-1 (195507M1)	30/278-4 (189391M92)	30/302-1 (195453M1)	33 T 30/280-1 (180415M1)	23 T 30/281-1 (180419M1)	30/266-1 (3008252X1)

Les références des pièces sont indicatives.
Nos pièces ne sont pas d'origine

Part numbers are quoted for reference purposes only.
Our parts and accessories are not original.



"THE RELIABLE SERVICE"



TRANSMISSION - ARBRES DE RENVOI
TRANSMISSION - COUNTERSHAFTS

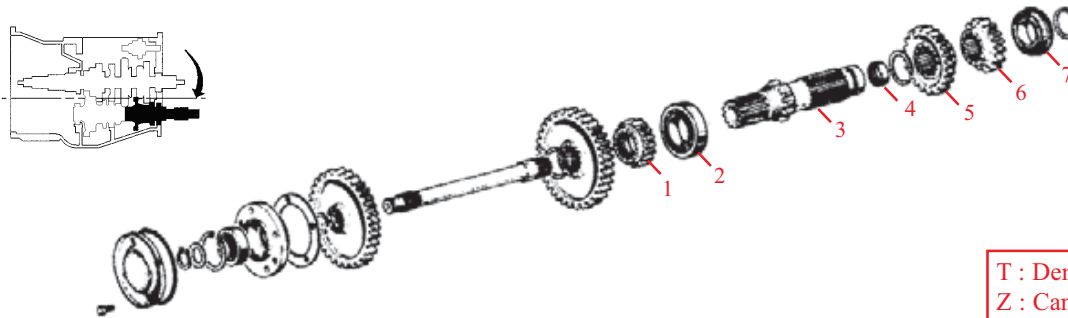

T : Dents / Teeth
Z : Cannelures / Splines

Fig.	1	2	3	4	5	6	7
Tracteurs Tractors	Pignon Pinion	Roulement Bearing	Arbre renvoi Countershaft	Roul. aiguille Needle bear.	Pignon Pinion	Pignon Pinion	Roulement Bearing
Boîte synchronisée Multipower / Multipower synchronesh							
265, 275, 290, 560, 575, 590, 675, 690 (2RM / 2WD)		30/277-1 (195507M1)	30/278-4 (189391M92)				
290 (⇒ 387020), 575, 590, 595, 690, 698 (⇒ 1984), 1200, 1250		30/277-3 (3003372X1)		30/302-1 (195453M1)	33 T 30/280-2 (1617923M3)		30/266-1 (3008252X1)
290 (387021 ⇒), 365, 375, 390, 398, 399, 690, 698 (1984 ⇒), 698T, 699						20 T 30/281-5 (1687430M1)	
Boîte 12 vitesses synchronisées / 12 speed synchronesh							
					3 ^{ème} 3 rd	2 ^{ème} 2 nd	
158 MKIII, 168 MKIII, 253, 265, 275, 275E, 290, 290E, 298, 350, 352, 355, 360, 362, 365, 375, 375E, 390, 390E, 396, 398, 399, 675, 690, 698, 698T, 699, 1004T, 592, 595, 1004		30/277-3 (3003372X1)	30/278-10 (1677827M3)	30/302-1 (195453M1)	33 T 30/280-2 (1617923M3)	20 T 30/281-5 (1687430M1)	30/266-1 (3008252X1)
Boîte 12 x 4 manuelle / 12 x 4 manual							
4215, 4220, 4225, 4235, 4240, 4245, 4255, 4260, 4265, 4270, 4315, 4320, 4325, 4335, 4345, 4355, 4360, 4365, 4370		30/277-3 (3003372X1)		2RM / 2WD 30/302-1 (195453M1)	33 T 30/280-2 (1617923M3)	20 T 30/281-5 (1687430M1)	30/266-1 (3008252X1)

 **Note : Voir pages MF-266 à MF-268 pour d'autres pièces de boîtes 12 vitesses synchronisées**
Note : See pages MF-266 to MF-268 for other 12 speed synchronesh parts

Les références des pièces sont indicatives.
Nos pièces ne sont pas d'origine

Part numbers are quoted for reference purposes only.
Our parts and accessories are not original.



TRANSMISSION - PIGNON INTERMEDIAIRE MARCHE ARRIERE
TRANSMISSION - REVERSE IDLER GEAR

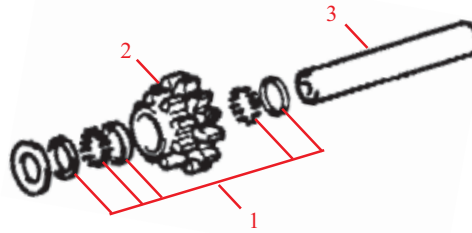
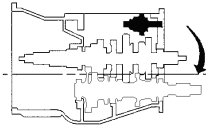

T : Dents / Teeth
Z : Cannelures / Splines

Fig.	1	2	3
Tracteurs Tractors	Jeu roulement Bearing kit	Pignon intermédiaire Idler gear	Arbre Shaft
Boîte 6 vitesses prise constante / 6 speed constant mesh			
35, 65, 133, 135, 140, 145, 165, 175, 178, 240, 765, 835, 865, 1080	30/284-1 (830735M91)	21/13 T 30/285-1 (183040M1)	30/286-1 (180445M1)
Boîte 8 vitesses prise constante / 8 speed constant mesh			
133, 135, 140, 145, 148, 152, 155, 158, 165, 168, 185, 188 230, 235, 240, 243, 245, 250, 253, 263, 265, 275, 275E, 290, 290E 350, 355, 360, 362, 365, 375, 375E, 390, 390E 390T, 396 (⇒ E01398) 390T, 396 (E01399 ⇒)	30/284-1 (830735M91)	21/13 T 30/285-1 (183040M1)	30/286-1 (180445M1)
550, 565, 575, 590, 1085		21/13 T 30/285-1 (183040M1)	
Boîte 8 vitesses synchronisées / 8 speed synchronesh			
133, 135, 140, 145, 148, 152, 155, 158, 168, 188 230, 235, 240, 245, 250, 253, 255, 260, 265, 275, 285, 290, 290E 340, 342, 350, 352, 355, 360, 362, 365, 375, 390, 390E 560, 575, 590, 592, 595, 675	30/284-1 (830735M91)		30/286-1 (180445M1)
8 x 2 crash / 8 x 2 crash			
4225, 4235, 4240, 4245, 4255, 4315, 4320, 4325, 4335, 4345, 4355	30/284-1 (830735M91)	21/13 T 30/285-1 (183040M1)	30/286-1 (180445M1)
8 x 2 synchronisée / 8 x 2 synchronesh			
4225, 4235, 4240, 4245, 4255, 4325, 4335, 4345, 4355	30/284-1 (830735M91)		30/286-1 (180445M1)
Boîte Multipower prise constante / Multipower constant mesh			
35, 65, 133, 135, 140, 145, 148, 152, 155, 158, 165, 168, 175, 178, 185, 188, 765 235, 240, 245, 250, 265, 275, 285, 290 550, 560, 565, 575, 590, 595, 675 1080, 1085, 1200	30/284-1 (830735M91)	21/13 T 30/285-1 (183040M1)	30/286-1 (180445M1)
Boîte Multipower synchronisée / Multipower synchronesh			
290, 560, 575, 590, 595, 675, 690, 698, 698T, 699, 1200, 1250	30/284-1 (830735M91)		30/286-1 (180445M1)

Les références des pièces sont indicatives.
Nos pièces ne sont pas d'origine

Part numbers are quoted for reference purposes only.
Our parts and accessories are not original.



TRANSMISSION - PIGNON INTERMEDIAIRE MARCHE ARRIERE
TRANSMISSION - REVERSE IDLER GEAR

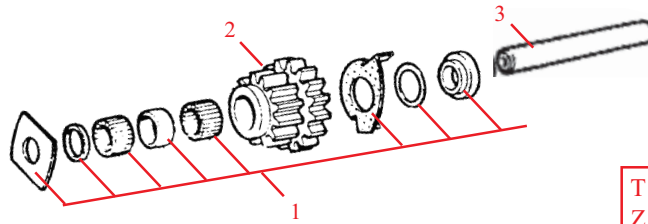
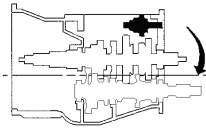

T : Dents / Teeth
Z : Cannelures / Splines

Fig.	1	2	3
Tracteurs Tractors	Jeu roulement Bearing kit	Pignon intermédiaire Idler gear	Arbre Shaft
Boîte 12 vitesses synchronisées / 12 speed synchronesh			
158 MKIII, 168 MKIII, 260, 265, 275, 290, 298	30/284-1 (830735M91)		30/286-1 (180445M1)
253, 275E, 290E	30/6310-1 (B631001)	21/14 T 30/275-3 (1688127M1)	
350, 352, 355, 360, 362, 365, 375, 375E, 390, 390E, 390T, 396, 398, 399			
575, 590, 592, 595, 675, 690, 698, 698T, 699, 1004, 1004T	30/284-1 (830735M91)		
Boîte 12 vitesses synchronisées Multipower / 12 speed multipower synchronesh			
365, 375, 390, 390T, 398, 399	30/6310-1 (B631001)	21/14 T 30/275-3 (1688127M1)	30/286-1 (180445M1)
12 x 4 manuelle / 12 x 4 manual			
4215, 4220, 4225, 4235, 4240, 4245, 4255, 4260, 4265, 4270, 4315, 4320, 4325, 4335, 4345, 4355, 4360, 4365, 4370	30/6310-1 (B631001)	21/14 T 30/275-3 (1688127M1)	30/286-1 (180445M1)

Jeu roulement Bearing kit	Contenu Contains	OEM	Quantité Quantity	Désignation Description
30/284-1 (830735M91)	30/284-1A	183037M1	2	Rondelle / Washer
	30/284-1B	183038M1	1	Entretoise / Spacer
	30/284-1C	183039M1	56	Aiguille / Needle roller
30/6310-1 (B631001)	30/284-1A	183037M1	1	Rondelle / Washer
	30/284-1C	183039M1	56	Aiguille / Needle roller
	30/6311-1	1688132M1	1	Rondelle butée / Thrust washer
	30/6312-1	1688131M1	1	Entretoise / Spacer
	30/6313-1	1688128M1	1	Disque de friction / Friction disc
	30/6314-1	1688129M1	1	Ressort / Disc spring
30/6315-1	1688130M1	1	Rondelle butée / Thrust washer	

Les références des pièces sont indicatives.
Nos pièces ne sont pas d'origine

Part numbers are quoted for reference purposes only.
Our parts and accessories are not original.



TRANSMISSION - KITS DE ROULEMENTS
TRANSMISSION - BEARING KITS

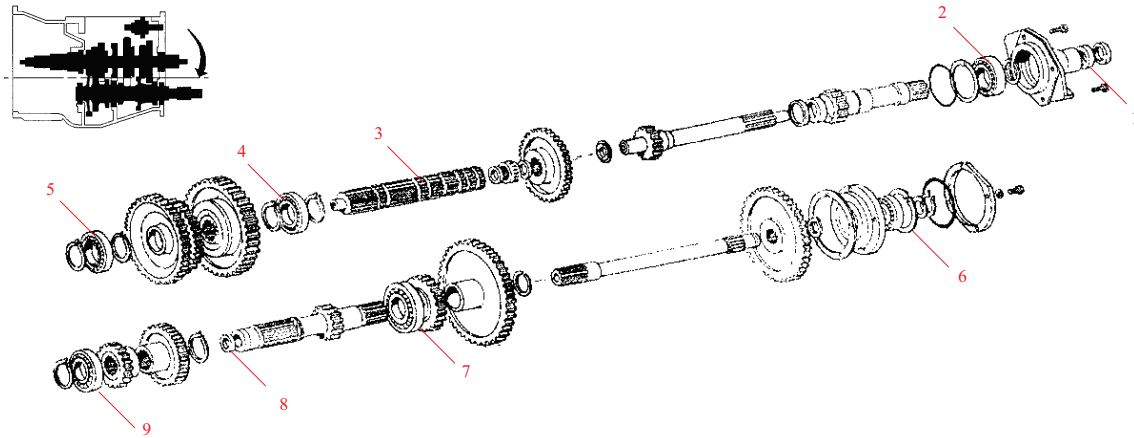

Jeu roulement Bearing kit	Contenu Contains	OEM	Qté Qty	Fig.	Désignation Description
30/6250-1K Kit roulement boîte 8 vitesses 8 speed bearing kit	30/251-1	886668M1	1	1	Roulement à aiguille arbre d'entrée PDF / PTO input shaft needle bearing
	30/252-2	834303M1	1	2	Roulement arbre d'entrée PDF / PTO input shaft bearing
	30/264-1	2700273M1	1	3	Roulement à aiguille arbre primaire / Mainshaft needle bearing
	30/261-2	338552X1	1	4	Roulement avant arbre primaire / Mainshaft front bearing
	30/266-1	3008252X1	1	5	Roulement arrière arbre primaire / Mainshaft rear bearing
	30/292-1	899377M2	1	6	Roulement arbre PDF / PTO shaft bearing
	30/277-1	195507M1	1	7	Roulement avant arbre de renvoi / Countershaft front bearing
	30/302-1	195453M1	1	8	Roulement à aiguille arbre de renvoi / Countershaft needle bearing
	30/266-1	3008252X1	1	9	Roulement arrière arbre de renvoi / Countershaft rear bearing
30/6250-2K Kit roulement boîte 6 vitesses 6 speed bearing kit	30/252-1	3009388X1	1	1	Roulement avant arbre d'entrée PDF / PTO input shaft front bearing
	30/252-1	3009388X1	1	2	Roulement arrière arbre d'entrée PDF / PTO input shaft rear bearing
	30/261-1	195505M1	1	3	Roulement arbre d'entrée primaire / Main input shaft bearing
	30/261-1	195505M1	1	4	Roulement avant arbre primaire / Mainshaft front bearing
	30/266-1	3008252X1	1	5	Roulement arrière arbre primaire / Mainshaft rear bearing
	30/292-1	899377M2	1	6	Roulement arbre PDF / PTO shaft bearing
	30/277-1	195507M1	1	7	Roulement avant arbre de renvoi / Countershaft front bearing
	30/302-1	195453M1	1	8	Roulement à aiguille arbre de renvoi / Countershaft needle bearing
	30/266-1	3008252X1	1	9	Roulement arrière arbre de renvoi / Countershaft rear bearing

TRANSMISSION - DISQUES MULTIPOWER
TRANSMISSION - MULTIPOWER DISCS

Tracteurs Tractors	Fig.	Réf. Ref.	OEM	Description
35, 65, 133, 135, 140, 145, 148, 152, 155, 158, 165, 168, 175, 178, 185, 188, 235, 240, 245, 250, 260, 265, 275, 285, 290, 298, 365, 375, 390, 390T, 398, 399, 550, 560, 565, 575, 590, 675, 690, 698, 698T, 699, 765	1	30/317-1	1672626M1	Disque de friction Friction disc Ø 128mm - 57Z - 88x94mm
	2	30/315-1	185464M1	Disque intermédiaire Intermediate disc Ø 144mm - 6Z
	3	30/314-1	186519M1	Ressort Spring 

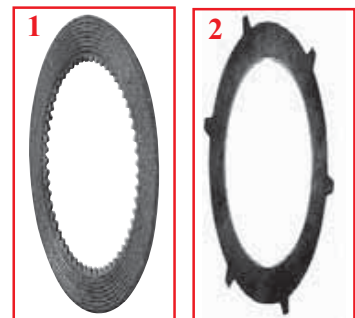

Les références des pièces sont indicatives.
Nos pièces ne sont pas d'origine

Part numbers are quoted for reference purposes only.
Our parts and accessories are not original.



TRANSMISSION - POUR TRACTEURS SERIES 200, 300, 500 & 600
TRANSMISSION - FOR 200, 300, 500 & 600 SERIES TRACTORS

Arbre d'entrée / Input shaft

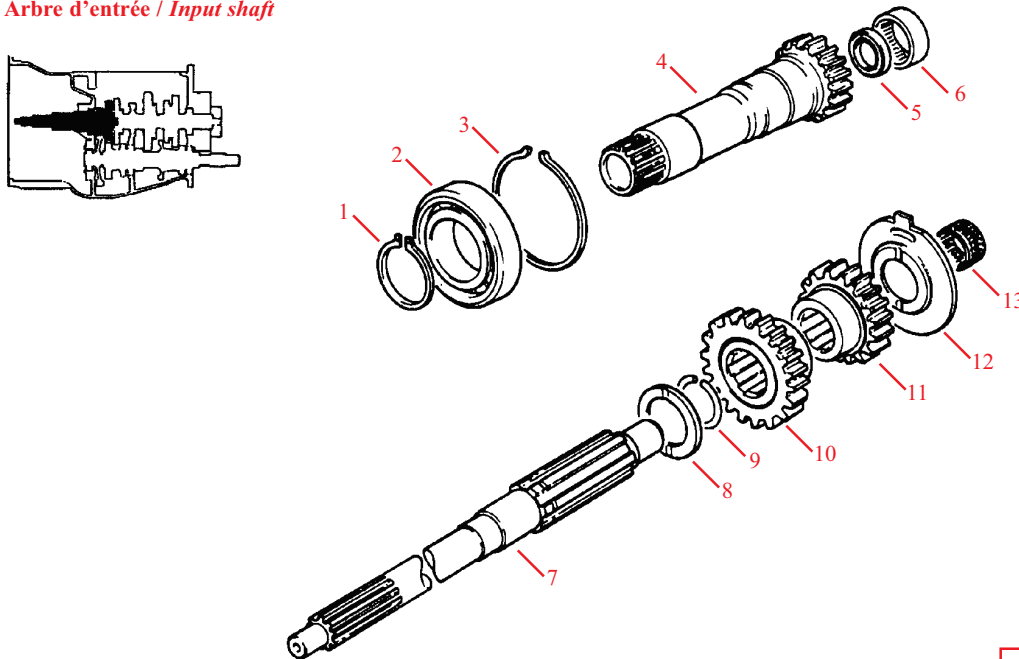

T : Dents / Teeth
Z : Cannelures / Splines

Boîte 12 vitesses synchronisées - Arbre d'entrée / 12 speed synchromesh - Input shaft parts

Réf. Ref.	OEM	Fig. Fig.	Désignation Description	Dimensions Dimensions
30/6284-2	762101M1	1	Circlip / Circlip	
30/252-2	834303M1	2	Roulement / Bearing	
30/6284-3	377631X1	3	Anneau / Snap ring	
30/255-9	1677738M1	4	Arbre d'entrée PDF / PTO input shaft	20 z - Ø 98.77 mm
30-256-3	883935M4	5	Bourrage / Oil seal	
30/251-2	1677724M1	6	Roulement / Bearing	
30/258-16	1692502M2	7	Arbre d'entrée / Main drive input shaft	6 x 21 z
30/6283-3	1677742M2	8	Rondelle / Thrust washer	
30/6284-4	358969X1	9	Anneau / Snap ring	
30/6287-1	1692497M1	10	Pignon prise constante - High / Constant mesh gear - High	29 T
30/6288-1	1692496M2	11	Pignon prise constante - Low / Constant mesh gear - Low	25 T
30/6289-1	1674668M3	12	Entretoise / Spacer	
30/264-1	2700273M1	13	Roulement à aiguille / Needle bearing	

Les références des pièces sont indicatives.
Nos pièces ne sont pas d'origine

Part numbers are quoted for reference purposes only.
Our parts and accessories are not original.



TRANSMISSION - POUR TRACTEURS SERIES 200, 300, 500 & 600
TRANSMISSION - FOR 200, 300, 500 & 600 SERIES TRACTORS

Arbre primaire / Mainshaft

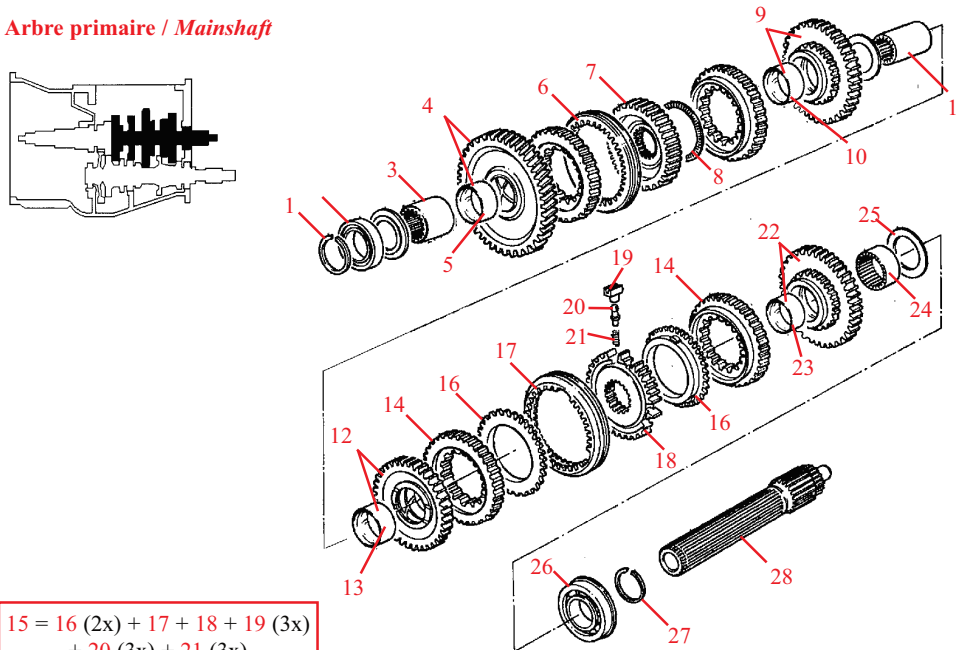

15 = 16 (2x) + 17 + 18 + 19 (3x)
+ 20 (3x) + 21 (3x)

T : Dents / Teeth
Z : Cannelures / Splines

Boîte 12 vitesses synchronisées - Arbre primaire / 12 speed synchromesh - Mainshaft parts

Réf. Ref.	OEM	Fig.	Description	Dimensions
30/6284-2	762101M1	1	Circlip / Circlip	
30/261-2	338552X1	2	Roulement avant / Front bearing	
30/6286-1	1617893M1	3	Manchon cannelé 1 ^{ère} / Splined sleeve - 1 st gear	
30/262-10	1686467M91	4	Pignon 1 ^{ère} / Gear - 1 st	42 T
30/6285-1	1617890M1	5	Bague de pignon 1 ^{ère} / Bush - 1 st gear	
30/272-3	1672957M1	6	Coupleur 1 ^{ère} -marche arr. (1 ^{er} mod.) / Sliding coupler-1 st -Reverse (Early)	
30/272-4	1686443M1	6	Coupleur 1 ^{ère} -marche arr. (dem mod.) / Sliding coupler-1 st -Reverse (Late)	
30/282-4	1664556M2	7	Moyeu 1 ^{ère} -marche arr. / Hub - 1 st -Reverse	
30/6290-1	1663796M1	8	Roulement à aiguilles / Needle bearing	
30/285-7	1686468M91	9	Pignon - Marche arrière / Gear - Reverse	44 T
30/6285-2	1867246M1	10	Bague - Pignon marche arrière / Bush - Reverse gear	
30/6286-2	1617892M1	11	Manchon cannelé 3 ^{ème} -marche arr. / Splined sleeve - Reverse-3 rd gear	
30/259-10	1686028M91	12	Pignon 3 ^{ème} / Gear 3 rd	36 T
30/6285-3	1867250M1	13	Bague de pignon 3 ^{ème} / Bush - 3 rd gear	
30/6291-1	1685067M1	14	Cône cannelé synchronisé / Splined synchromesh cone	2 par arbre primaire / 2 per Mainshaft
30/6292-1	1677238M93	15	Pignons 2 ^{ème} -3 ^{ème} synchronisé / Synchromesh gear assy 2 nd -3 rd	16+17+18+19+20+21+16
30/6293-1	1684022M1	16	Anneau / Synchroniser ring	2 avec / in 30/6292-1
30/6294-1	1686796M1	17	Coulisseau / Sliding coupler	1 avec / in 30/6292-1
30/6295-1	1671773M3	18	Moyeu principal / Drive hub	1 avec / in 30/6292-1
30/6296-1	3033849M1	19	Poussoir / Pressure block	3 avec / in 30/6292-1
30/6297-1	3188958M1	20	Goupille sphérique / Pressure plunger	3 avec / in 30/6292-1
30/6298-1	3698240M1	21	Ressort de pression / Pressure spring	3 avec / in 30/6292-1
30/263-11	1687429M91	22	Pignon 2 ^{ème} / Gear - 2 nd	
30/6285-2	1867246M1	23	Bague - Pignon 2 ^{ème} / Bush - 2 nd gear	
30/6286-3	1617894M1	24	Manchon cannelé - 2 ^{ème} / Splined sleeve - 2 nd gear	
30/6283-4	1867259M1	25	Rondelle / Thrust washer	
30/266-1	3008252X1	26	Roulement arrière / Rear bearing	
30/6284-5	195363M1	27	Anneau / Snap ring	55.6 x 46.1 x 2.4 mm
30/265-19	1662224M2	28	Arbre primaire / Mainshaft	

Les références des pièces sont indicatives.
Nos pièces ne sont pas d'origine

Part numbers are quoted for reference purposes only.
Our parts and accessories are not original.



TRANSMISSION - POUR TRACTEURS SERIES 200, 300, 500 & 600
TRANSMISSION - FOR 200, 300, 500 & 600 SERIES TRACTORS

Arbre de renvoi / Countershaft

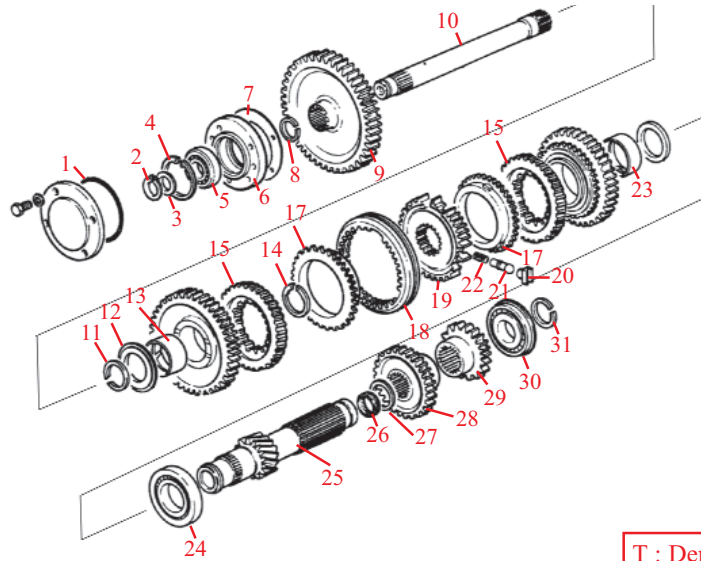
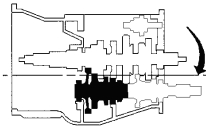

16 = 17 (2x) + 18 + 19 + 20 (3x)
+ 21 (3x) + 22 (3x)

T : Dents / Teeth
Z : Cannelures / Splines

Boîte 12 vitesses synchronisées - Arbre de renvoi / 12 speed synchromesh - Countershaft parts

Réf. Ref.	OEM	Fig. Fig.	Désignation Description	Dimensions Dimensions
30/306-2	1004633M1	1	Joint torique / "O" Ring	
30/6284-11	899385M1	2	Circlip / Circlip	31.3 x 26.4 x 1.3 mm
30/6283-6	881122M2	3	Rondelle / Washer	
30/6284-10	355988X1	4	Circlip / Circlip	79.5 x 71.4 x 2.4 mm
30/292-1	899377M2	5	Roulement avant PDF / PTO front bearing	
30/245-2	899331M1	6	Roulement arrière PDF / PTO front bearing housing	
30/6299-1	180432M1	7	Joint / Gasket	
30/6284-9	358913X1	8	Anneau / Snap ring	38.2 x 31.7 x 1.6 mm
30/293-3	1869708M1	9	Pignon PDF prise constante / PTO constant mesh gear	38 T
30/246-6	1869279M1	10	Arbre PDF / PTO drive shaft	
30/6284-6	831581M2	11	Anneau / Snap ring	52 x 45.7 x 2.9 mm
30/6283-5	1677829M1	12	Rondelle avant / Front thrust washer	
30/6285-4	1677828M2	13	Bague - Pignon gamme haute / Bush - High range gear	
30/6284-7	1440873X1	14	Circlip / Circlip	Ø ext. /out. 50 mm
30/6291-1	1685067M1	15	Pignon coique cannelé / Splined synchromesh cone	2 par arbre de renvoi 2 per countershaft
30/6292-2	1677239M93	16	Jeu pignon synchronisé high/low / Synchromesh gear assy High/Low	
30/6293-1	1684022M1	17	Anneau de synchronisation / Synchroniser ring	2 avec / in 30/6292-2
30/6294-1	1686796M1	18	Coulisseau / Sliding coupler	1 avec / in 30/6292-2
30/6295-2	1677830M1	19	Manchon / Drive hub	1 avec / in 30/6292-2
30/6296-1	3033849M1	20	Poussoir/ Pressure block	3 avec / in 30/6292-2
30/6297-1	3188958M1	21	Goupille / Pressure plunger	3 avec / in 30/6292-2
30/6298-1	3698240M1	22	Ressort de pression / Pressure spring	3 avec / in 30/6292-2
30/6285-5	1682388M1	23	Bague - Pignon gamme basse / Bush - Low range gear	
30/277-3	3003372X1	24	Roulement avant - Arbre de renvoi / Front bearing - Countershaft	
30/278-10	1677827M3	25	Arbre de renvoi / Countershaft	
30/302-1	195453M1	26	Roulement à aiguille / Needle bearing	
30/6284-8	195500M1	27	Anneau / Snap ring	62.7 x 51.6 x 2.8 mm
30/280-2	1617923M3	28	Pignon 3 ^{ème} vitesse / Pinion 3 rd gear	33 T
30/281-5	1687430M1	29	Pignon 2 ^{ème} vitesse / Pinion - 2 nd gear	20 T
30/266-1	3008252X1	30	Roulement arrière - Arbre de renvoi / Rear bearing - Countershaft	
30/6284-5	195363M1	31	Anneau / Snap ring	55.6 x 46.1 x 2.4 mm

Les références des pièces sont indicatives.
Nos pièces ne sont pas d'origine

Part numbers are quoted for reference purposes only.
Our parts and accessories are not original.



"THE RELIABLE SERVICE"



**TRANSMISSION REVERSIBLE
INSTANT REVERSE TRANSMISSION**

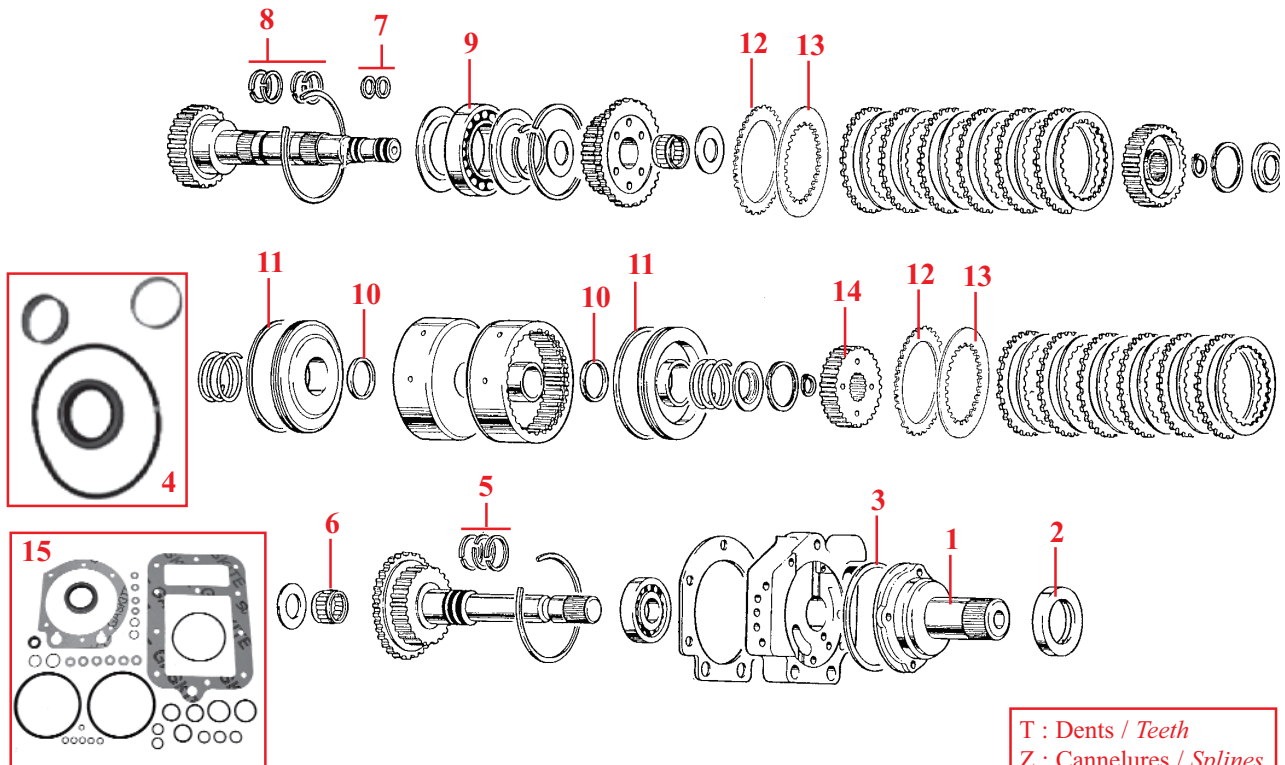

T : Dents / Teeth
Z : Cannelures / Splines

Tracteurs Tractors	Fig.	Réf. Ref.	OEM	Description
Industriel / Industrial 40, 50, 50B, 50B MKII, 50D, 50E	1	30/241-1	530718M92	Pompe à huile / Oil pump assy.
	2	30/242-1	844422M1	Bague / Oil seal
	3	30/243-1	1754392M1	O-ring / 'O' Ring
	4	30/244-1	2757272M92	Jeu de réparation / Pump seal kit 30/242-1 (844422M1) + 30/243-1 (1754392M1) + 2757270M1 + 2757271M1
	5	30/253-1	1754394M1	Segment / Piston ring
	6	30/254-1	1021790M1	Roulement / Bearing
	7	30/257-1	1754395M1	Segment / Piston ring
	8	30/257-2	1754402M1	Segment / Piston ring
	9	30/261-3	832544M2	Roulement / Bearing
	10	30/311-1	1004637M1, 1749440M1, 1754521M1	Joint de piston intérieur Inner piston seal
	11	30/312-1	1754525M1	Joint de piston extérieur Outer piston seal
	12	30/316-5	1754344M1	Disque intermédiaire / Intermediate disc Ø 139mm - 25Z
	13	30/317-7	1754345M2, 2757328M1	Disque de friction / Friction disc Ø 133mm - 45Z - 93x97mm
	14	30/322-1	1754523M1	Moyeu / Hub
	15	30/337-1	830979M93	Jeu de joint / Gasket set

Les références des pièces sont indicatives.
Nos pièces ne sont pas d'origine

Part numbers are quoted for reference purposes only.
Our parts and accessories are not original.



"THE RELIABLE SERVICE"



TRANSMISSION - FOURCHETTES DE SELECTIONS
TRANSMISSION - SELECTOR FORKS



Fig.	1	2	3	4	5
Tracteurs Tractors	Fourchette sél. Selector fork	Fourchette sél. Selector fork	Fourchette sél. Selector fork	Fourchette sél. Selector fork	Vis sélecteur Selector screw
Boîte 6 vitesses prise constante 6 speed constant mesh	Grande / Petite High / Low	1^{ère} / Arrière 1st / Reverse	2^{ème} / 3^{ème} 2nd / 3rd		
35, 65, 133, 135, 140, 145, 165, 175, 178, 240, 765, 1080	30/555-1 (897065M2)	30/556-1 (180437M1)	30/556-1 (180437M1)		30/557-1 (3771408M1)
Boîte 8 vitesses prise constante 8 speed constant mesh	Grande / Petite High / Low	1^{ère} / Arrière 1st / Reverse	3^{ème} 3rd	2^{ème} / 4^{ème} 2nd / 4th	
133, 135, 140, 145, 148, 152, 155, 158, 165, 168, 185, 188, 230, 235, 240 (Premiers / Early), 245, 250, 265, 275, 285, 290 275E, 290E, 375E, 390E (⇒ 08/96)	30/555-1 (897065M2)	30/556-2 (1860773M1)	30/556-3 (1873532M3)	30/556-2 (1860773M1)	30/557-1 (3771408M1)
240 (Demiers / Late), 243, 253, 263 275E, 290E, 375E, 390E (09/96 ⇒)					
350, 355, 360, 362, 365, 375, 390, 390T, 396					
550, 565, 575, 590 (UK), 1085		30/556-2 (1860773M1)	30/556-3 (1873532M3)	30/556-2 (1860773M1)	
590 (France), 592, 595					
Boîte 8 vitesses synchronisées 8 speed synchromesh	Grande / Petite High / Low	1^{ère} / Arrière 1st / Reverse	2^{ème} 2nd	3^{ème} / 4^{ème} 3rd / 4th	
133, 135, 140, 145, 148, 152, 155, 158, 168, 188, 230, 235, 240, 245, 250, 253, 255, 260, 265, 275, 285, 290 290E, 390E (⇒ 08/96)	30/555-1 (897065M2)	30/556-2 (1860773M1)	30/556-3 (1873532M3)		30/557-1 (3771408M1)
290E, 390E (09/96 ⇒)					
340, 342, 350, 352, 355, 360, 362, 365, 375, 390					
560, 575, 590, 595, 675		30/556-2 (1860773M1)	30/556-3 (1873532M3)		
590, 592, 595 (ZF)					
Boîte 8 vitesses synchronisées inverseur 8 speed synchromesh shuttle	Grande / Petite High / Low				
243, 253, 263, 350, 352, 355, 360, 362, 365, 375, 390, 390T	30/555-1 (897065M2)				30/557-1 (3771408M1)

Les références des pièces sont indicatives.
Nos pièces ne sont pas d'origine

Part numbers are quoted for reference purposes only.
Our parts and accessories are not original.



"THE RELIABLE SERVICE"



TRANSMISSION - FOURCHETTES DE SELECTIONS
TRANSMISSION - SELECTOR FORKS



Fig.	1	2	3	4	5
Tracteurs Tractors	Fourchette sél. Selector fork	Fourchette sél. Selector fork	Fourchette sél. Selector fork	Fourchette sél. Selector fork	Vis sélecteur Selector screw
Boîte Multipower <i>Multipower</i>	Grande / Petite <i>High / Low</i>	1^{ère} / Arrière <i>1st / Reverse</i>	2^{ème} / 3^{ème} <i>2nd / 3rd</i>		
35, 65, 133, 135, 140, 145, 148, 152, 155, 158, 165, 168, 175, 178, 185, 188, 235, 240, 245, 250, 260, 265, 275, 285, 290, 550, 560, 565, 575, 590 595, 675, 765, 1080, 1085, 1200	30/555-1 (897065M2)	30/556-1 (180437M1)	30/556-1 (180437M1)		30/557-1 (3771408M1)
Boîte Multipower synchronisée <i>Multipower synchromesh</i>	Grande / Petite <i>High / Low</i>	1^{ère} / Arrière <i>1st / Reverse</i>	2^{ème} / 3^{ème} <i>2nd / 3rd</i>		
265, 275, 290 MKI	30/555-1 (897065M2)	30/556-1 (180437M1)			30/557-1 (3771408M1)
290 MKII, 365, 375, 390, 390T, 398, 399					
560, 575, 675, 690 MKI		30/556-1 (180437M1)			
590, 595, 690 MKII, 698, 698T, 699, 1200, 1250					
Boîte 12 vitesses synchronisées <i>12 speed synchromesh</i>	Grande / Petite <i>High / Low</i>				
158 MKIII, 168 MKIII, 253, 260, 265, 275, 275E, 290, 290E, 298, 350, 352, 355, 360, 362, 365, 375, 375E, 390, 390E, 390T, 396, 398, 399, 575, 590, 592, 595, 675, 690, 698, 698T, 699, 1004, 1004T	30/555-1 (897065M2)				30/557-1 (3771408M1)

Les références des pièces sont indicatives.
Nos pièces ne sont pas d'origine

Part numbers are quoted for reference purposes only.
Our parts and accessories are not original.



POMMEAUX DE LEVIER DE VITESSES
GEAR LEVER KNOBS

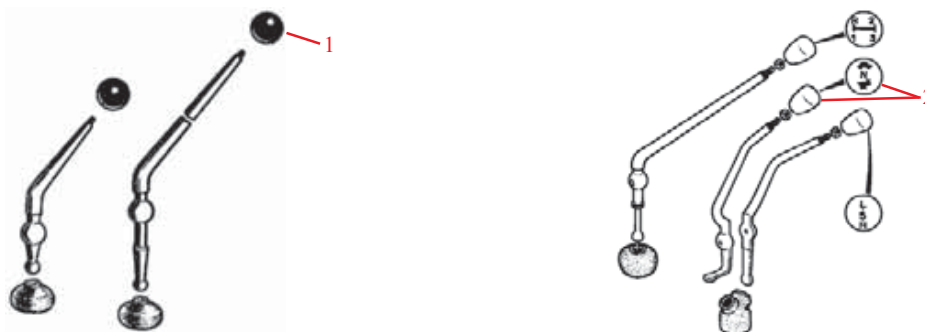

Tracteurs <i>Tractors</i>	Boule Grande/Petite <i>High/Low shift knob</i>	Boule levier de vitesses <i>Gear shift knob</i>	Boule levier synchro <i>Synchromesh knob</i>
Boîte 6 vitesses prise constante / 6 speed constant mesh			
35, 65, 145, 765, 835, 865	30/552-1 (1) (180006M91)	30/552-1 (1) (180006M91)	
133, 135, 140, 165, 175, 178, 240	30/552-6 (1) (1862399M1)	30/552-7 (1) (1862401M1)	
Boîte 8 vitesses prise constante / 8 speed constant mesh			
133, 135, 140, 145, 148, 152, 155, 158, 165, 168, 185, 188, 230, 235, 240, 245, 250, 265, 275, 275E, 290, 290E, 375E, 390E, 550, 565, 575, 590	30/552-6 (1) (1862399M1)	30/552-8 (1) (1862400M1)	
Boîte 8 vitesses synchronisées / 8 speed synchromesh			
133, 135, 140, 145, 148, 152, 155, 158, 168, 188, 230, 235, 240, 245, 250, 255, 260, 265, 275, 285, 290, 560, 575, 590, 592, 595, 675, 290E, 390E (2RM / 2WD ⇒ 07/94)	30/552-6 (1) (1862399M1)	30/552-15 (1) (1867275M1)	
Boîte Multipower & Multipower synchronisée / Multipower & Multipower synchromesh			
35, 65, 765	30/552-1 (1) (180006M91)	30/552-1 (1) (180006M91)	
133, 135, 140, 145, 148, 152, 155, 158, 165, 168, 175, 178, 185, 188, 235, 240, 245, 250, 260, 265, 275, 285, 290, 550, 560, 565, 575, 590, 595, 675, 690, 698, 698T, 699	30/552-6 (1) (1862399M1)	30/552-7 (1) (1862401M1)	
1200, 1250			
Boîte 12 vitesses synchronisées / 12 speed synchromesh			
158 MKIII, 168 MKIII, 260, 265, 275, 275E, 290, 290E, 298, 375E, 390E, 575, 590, 592, 595, 675, 690, 698, 698T, 699, 1004, 1004T	30/552-6 (1) (1862399M1)	30/552-7 (1) (1862401M1)	30/552-9 (2) (1677998M1)

Type de pommeau <i>Type of knob</i>	Logo <i>Icon</i>	Pommeau complet <i>Assembly</i>	Boule seule <i>Bare knob</i>	Symbole <i>Decal</i>
Pommeau du levier rapports haut et bas <i>High/Low shift knob</i>		30/552-6 (1862399M1)		30/553-1 (1682631M1)
Pommeau du levier selecteur multipower <i>Gear shift knob - 6 & 12 speed Multipower</i>		30/552-7 (1862401M1)		30/553-2 (1682630M1)
Pommeau du levier - 8 vitesses <i>Gear shift knob - 8 speed</i>		30/552-8 (1862400M1)	30/552-4 (1682623M1)	30/553-3 (1682629M1)
Pommeau du levier - 8 vitesses synchro <i>Gear shift knob - 8 speed synchromesh</i>		30/552-15 (1867275M1)		30/553-4 (1682628M1)
Pommeau du levier synchro <i>Synchromesh knob</i>		30/552-9 (1677998M1)		30/553-9 (1682632M2)

Les références des pièces sont indicatives.
Nos pièces ne sont pas d'origine

Part numbers are quoted for reference purposes only.
Our parts and accessories are not original.



SOUFFLETS DE LEVIERS DE VITESSES
GEAR LEVER BOOTS

Tracteurs Tractors	Réf. Ref.	Illustration Illustration
Tracteurs français, anglais et américains / French, UK & USA tractors		
<p>Boîtes 6 & 8 vitesses & Multipower (High/Low & levier vitesses) <i>6 & 8 Speed & Multipower (High/Low & Gear Shift)</i> 35, 65, 133, 135, 140, 145, 148, 152, 155, 158, 165, 168, 175, 178, 185, 188, 235, 245, 250, 255, 260, 265, 275, 285, 290, 550, 565, 575, 590, 592, 595, 675, 690, 698T, 699 230, 240, 253, 275E, 290E, 375E, 390E (⇒ 25/08/93) 340, 350, 355, 360, 362, 365, 375, 390, 390T, 396, 398, 399 (High/Low seulement / only ⇒ B01671) Boîte 12 vitesses synchronisées (levier de vitesses) / <i>12 Speed Synchromesh (Gear Shift)</i> 158 MK111, 168 MK111, 260, 265, 275, 290, 298 275E, 290E, 375E, 390E (⇒ 25/08/93)</p>	<p>30/551-1 (180579M3)</p>	
<p>Boîte 8 vitesses & Multipower (High/Low & levier de vitesses) <i>8 Speed & Multipower (High/Low & Gear Shift)</i> 230, 240, 253, 275E, 290E, 375E, 390E (26/08/93 ⇒) 340, 350, 355, 360, 362, 365, 375, 390, 390T, 396, 398, 399 (High/Low B10672 ⇒ & tous leviers de vitesses / <i>all Gear Shift</i>) 243, 263, 342, 352 Boîte 8 vitesses levier central tracteurs marchepied (High/Low & levier de vitesses) <i>8 Speed Centre Shift Footstep Tractors (High/Low & Gear Shift)</i> 4225, 4235, 4245, 4255, 4260, 4270, 4315, 4320, 4325, 4335, 4345, 4355, 4360, 4370 Boîte 12 vitesses synchronisées (levier de vitesses) / <i>12 Speed Synchromesh (Gear Shift)</i> 275E, 290E, 375E, 390E (26/08/93 ⇒) 253, 350, 352, 355, 360, 362, 365, 375, 390, 390T, 396, 398, 399 Boîte 12 x 4 vitesses levier central tracteurs marchepied (levier de vitesses) <i>12 x 4 Speed Centre Shift Footstep Tractors (Gear Shift)</i> 4225, 4235, 4245, 4255, 4260, 4265, 4270, 4315, 4320, 4325, 4335, 4345, 4355, 4360, 4365, 4370</p>	<p>30/551-12 (1694127M3)</p>	
<p>Boîte 8 vitesses synchronisées inverseur (High/Low & sélection synchro) <i>8 Speed Synchromesh Shuttle (High/Low & Synchromesh Shift)</i> 243, 253, 263, 340, 342, 352, 355, 360, 362, 365, 375, 390 Boîte 12 vitesses synchronisées (High/Low & sélection synchro) <i>12 Speed Synchromesh (High/Low & Synchromesh Shift)</i> 158 MK111, 168 MK111, 253, 260, 265, 275, 275E, 290, 290E, 298, 350, 352, 355, 360, 362, 365, 375, 375E, 390, 390E, 390T, 396, 398, 399, 575, 590, 592, 595, 675, 690, 698, 698T, 699, 1004, 1004T Boîte 12 x 4 vitesses levier central tracteurs marchepied (High/Low & sélection synchro) <i>12 x 4 Speed Centre Shift Footstep tractors (High/Low & Synchromesh Shift)</i> 4225, 4235, 4245, 4255, 4260, 4265, 4270, 4315, 4320, 4325, 4335, 4345, 4355, 4360, 4365, 4370</p>	<p>30/551-11 (1694126M3)</p>	
Tracteurs italiens / Italian tractors		
<p>134, 154, 164T, 174, 184, 194, 234, 254, 264T, 274, 294 (Tous modèles / <i>All models</i>) 233, 244CF, 263T, 273, 283, 284, 293, 353LX, 363LX, 364CF, 373LX, 383LX, 393LX, 393TLX, 394C, 2205, 2210, 2220, 2225, 2230, 2235</p>	<p>30/551-17 (1824689M1)</p>	

Les références des pièces sont indicatives.
Nos pièces ne sont pas d'origine

Part numbers are quoted for reference purposes only.
Our parts and accessories are not original.



LEVIERS DE VITESSES & ACCESSOIRES
GEAR SHIFT LEVER PARTS

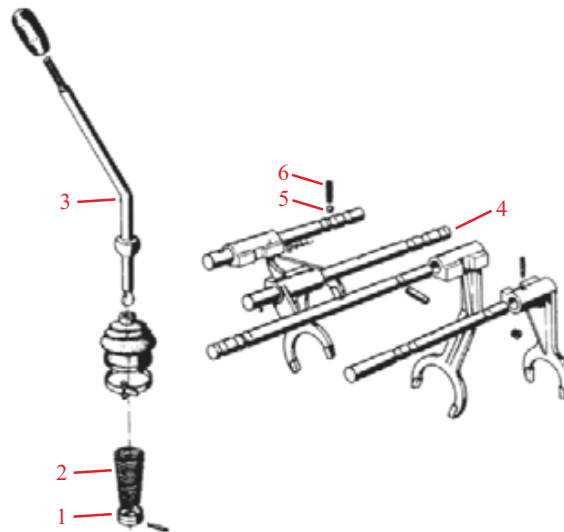

Fig.	1	2
Tracteurs <i>Tractors</i>	Anneau de retient <i>Spring retainer</i>	Ressort de tension <i>Tension spring</i>
TE 20	30/551-15 (1861024M1)	30/551-16 (192007M1)
Boîtes 6 vitesses, 8 vitesses prise constante, Multipower et synchronisées (sauf ZF) <i>6 speed, 8 speed constant, Multipower & Synchronmesh (except ZF)</i> 35, 65, 133, 135, 140, 145, 148, 152, 155, 158, 165, 168, 175, 178, 185, 188, 230, 235, 240, 245, 250, 253, 255, 260, 265, 275, 285, 290, 550, 560, 565, 575, 590, 592, 595, 765, 835, 865		
Boîtes 8 vitesses ZF Multipower et synchronisées <i>8 speed ZF Multipower & Synchronmesh</i> 133, 135, 145, 148, 152, 158, 168, 235, 245, 250, 255, 260, 265, 275, 290, 560, 575, 590, 592, 595, 675, 690, 698, 698T, 699 230, 240, 253, 275E, 290E, 375E, 390E (⇒ 25-08-93)		
Boîtes 8 vitesses prise constante, Multipower et synchronisées <i>8 speed constant, Multipower & Synchronmesh</i> 340, 350, 355, 360, 362, 365, 375, 390, 390T, 396 (⇒ A33000)		
Boîtes 12 vitesses synchronisées <i>12 Speed Synchronmesh</i> 158 MKIII, 168 MKIII, 260, 265, 275, 290, 298, 575, 590, 592, 595, 675, 690, 698, 698T, 699, 1004, 1004T 275E, 290E, 375E, 390E (⇒ 25-08-93) 350, 355, 360, 362, 365, 375, 390, 390T, 396, 398, 399 (⇒ A33000)	30/551-20 (368233X1)	

Fig.	3	4	5	6
Tracteurs italiens <i>Italian tractors</i>	Levier de vitesses <i>Gear lever</i>	Rail sélecteur <i>Selector rail</i>	Bille <i>Ball</i>	Ressort <i>Spring</i>
154, 174, 184, 194, 234S, 254, 254S, 274, 274S	30/554-2 (3300965M1)			
233, 253, 263T, 264T, 264TS, 273, 274SK, 283, 284, 293, 294 254, 254S, 274, 274S, 294S (Derniers / Late)		30/556-9 (3305099M1)		
Séries 100, 200, 300, 1000, 1100, 2200, 3200 series			30/556-10 (361031X1)	30/556-11 (3305061M1)

Les références des pièces sont indicatives.
Nos pièces ne sont pas d'origine

Part numbers are quoted for reference purposes only.
Our parts and accessories are not original.



**PRISE DE FORCE
PTO**

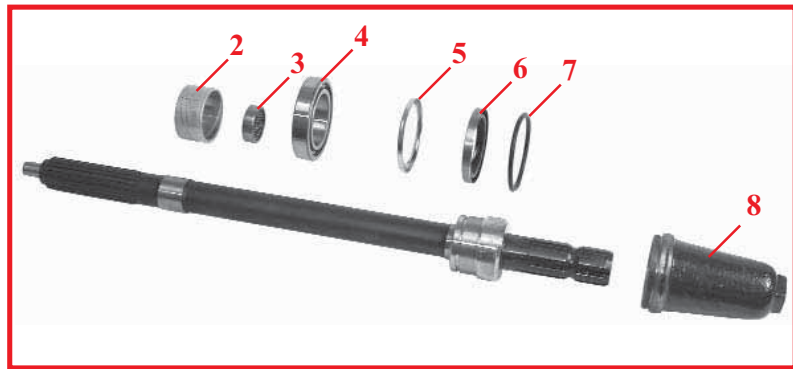
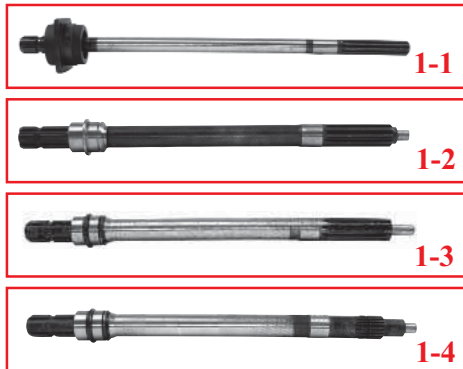

Tracteurs Tractors	Fig.	Réf. Ref.	OEM	Description	Observation
TE20	1-1	30/303-76	181169M91 181173M1	Arbre complet avec bitier Complete shaft with house	1 3/8" replace / 1 1/8" replace
	6	30/305-3	1190	Bague / PTO oil seal	
35, 65, 175, 178, 765	1-2	30/303-1	181204M92	Arbre-1 vitesse-540 T/min Shaft-1 speed-540 RPM	L :580m A :1 3/8" 6Z B :1 3/8" 10Z
	2	30/301-1	908622M1	Bague / Bush	
	3	30/302-1	195453M1	Rollant / Bearing	1 3/8" x 1 5/8" x 1 1/2"
	4	30/304-1	195498M1	Rollant avec sécurité 195284M1 Bearing with safety 195284M1	45 x 75 x 16m
	6	30/305-1	1077452M1	Bague / PTO oil seal	Ø int / Inn. Ø 45m
	7	30/306-1	195522M1	Joint torique / O-ring	Ø 1m
	8	30/308-4	1868778M1	Protection / House	Ø 7m
133, 135, 140, 152, 155, 158, 165 PTO latéral/ Side PTO	1-3	30/303-90	1867085M91	Arbre-1 vitesse Shaft 1 speed	L :598m A :1 3/8" 6Z B :1 3/8" 10Z
	2	30/301-1	908622M1	Bague / Bush	
	3	30/302-1	195453M1	Rollant / Bearing	1 3/8" x 1 5/8" x 1 1/2"
	4	30/304-1	195498M1	Rollant avec sécurité 195284M1 Bearing with safety 195284M1	45 x 75 x 16m
	6	30/305-1	1077452M1	Bague / PTO oil seal	Ø int / Inn. Ø 45m
	7	30/306-1	195522M1	Joint torique / O-ring	Ø 1m
	8	30/308-4	1868778M1	Protection / House	Ø 7m
133, 135, 140, 152, 155, 158, 165, 168, 185, 188	1-4	30/303-20	1867082M91	Arbre-1 vitesse-IPTO hydraulique Shaft-1 speed-Hydraulic IPTO	L :577m A :1 3/8" 6Z B :1 3/8" 21Z
	3	30/302-1	195453M1	Rollant / Bearing	1 3/8" x 1 5/8" x 1 1/2"
	4	30/304-1	195498M1	Rollant avec sécurité 195284M1 Bearing with safety 195284M1	45 x 75 x 16m
	6	30/305-1	1077452M1	Bague / PTO oil seal	Ø int / Inn. Ø 45m
	7	30/306-1	195522M1	Joint torique / O-ring	Ø 1m
	8	30/308-4	1868778M1	Protection / House	Ø 7m

Les références des pièces sont indicatives.
Nos pièces ne sont pas d'origine

Part numbers are quoted for reference purposes only.
Our parts and accessories are not original.



PRISE DE FORCE
PTO

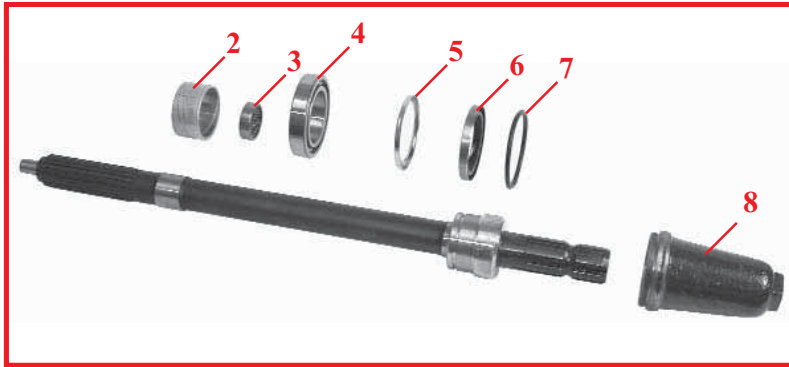
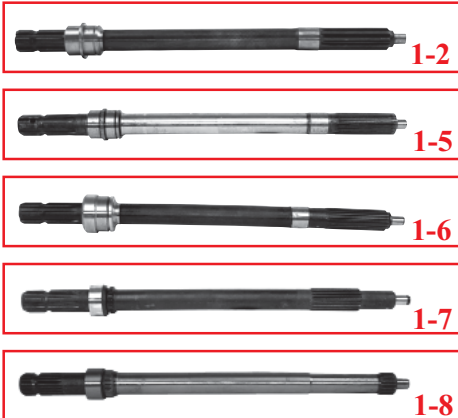

Tracteurs Tractors	Fig.	Réf. Ref.	OEM	Description	Observation	
133, 135, 148, 165, 168, 185, 188	1-2	30/303-1	181204M92	Arbte-1 vitesse-540 T/m 1ère série Shaft-1 speed-540 RPM 1st series	L :580m A :1 3/8"76Z - B :1 3/8"10Z	
	1-5	30/303-19	1868557M93	Arbte-1 vitesse-540 T/m 2ème série Shaft-1 speed-540 RPM 2nd series	L :615mA :1 3/8"76Z B :1 3/8"21Z - C :Ø5m	
	1-6	30/303-16	1660288M91	Arbte-1 vitesse-540 T/m 3ème série Shaft-1 speed-540 RPM 3rd series	L :615mA :1 3/8"76Z B :1 3/8"21Z - C :Ø6m	
	2	30/301-1	908622M1	Baga / Bush		
	3	30/302-1	195453M1	Robant / Bearing	13/8"x 1 5/8"x 1 1/2"	
	4	30/304-1	195498M1	Robant avec sreté 195284M1 Bearing with safety 195284M1	45 x 75 x 16 1ère & 2ème séries / 1st & 2nd series	
	4	30/304-2	391261X1	Robant / Bearing	55 x 90 x 18 3ème série / 3rd series	
	6	30/305-1	1077452M1	Baga / PTO oil seal	Ønt. / Inn. Ø 45m 1ère & 2ème séries / 1st & 2nd series	
	6	30/305-7	834216M1	Baga / PTO oil seal	Ønt. / Inn. Ø 60m 3ème série / 3rd series	
	5	30/305-8	533183M1	Joint / Seal	Ønt. / Inn. Ø 65m	
	7	30/306-1	195522M1	Joint toriq / O-ring	Ø.1m	
	7	30/306-2	1004633M1	Joint toriq / O-ring	Ø.2m	
	8	30/308-2	532888M2	Protection / House	Ø9m 3ème série / 3rd series	
	8	30/308-4	1868778M1	Protection / House	Ø7m 1ère & 2ème séries 1st & 2nd series	
230, 235, 240, 245, 250, 253, 260, 263, 265, 275, 285, 290, 350, 355, 360, 365, 375, 390, 550, 560, 565, 575, 590, 675	1-6	30/303-16	1660288M91	Arbte-1 vitesse-540 T/m Shaft-1 speed-540 RPM	L :615mA :1 3/8"76Z B :1 3/8"21Z - C :Ø6m	
Voir ci-dessous pour autres pièces associées / See also below for other related parts						
250, 255, 260, 265, 275, 285, 290, 298, 355, 360, 362, 365, 375, 390, 398, 399, 560, 565, 575, 590, 675, 690, 698, 699, 1104	1-7	30/303-17	532899M1	Arbte-2 vitesses-540 T/m Shaft-2 speed-540 RPM	L :615mA :1 3/8"76Z B :1 3/8"21Z	
		30/303-17A	3599000M2	Arbte-2 vitesses-540 T/m Shaft-2 speed-540 RPM	L :615mA :1 3/8"76Z B :1 3/8"21Z	
	Voir ci-dessous pour autres pièces associées / See also below for other related parts					
Pièces associées pour arbres Related parts for shafts 30/303-16 30/303-17 30/303-18	1-8	30/303-18	532897M1	Arbte-2 vitesses-1000 T/m Shaft-2 speed-1000 RPM	L :615mA :1 3/8"21Z B :1 3/8"21Z	
	Voir ci-dessous pour autres pièces associées / See also below for other related parts					
	2	30/301-2	532883M1	Baga / Bush		
	3	30/302-1	195453M1	Baga / Bush	13/8"x 1 5/8"x 1 1/2"	
	4	30/304-2	391261X1	Robant / Bearing	55 x 90 x 18 (⇒ P38370)	
	4	30/304-3	391162X1	Robant / Bearing	50 x 80 x 20 (P38371 ⇒)	
	6	30/305-7	834216M1	Baga / PTO oil seal	Ønt. / Inn. Ø 60m (⇒ P38370)	
	6	30/305-22	3699801M1	Baga / PTO oil seal	50x80.6 (P38371 ⇒)	
5	30/305-8	533183M1	Joint / Seal	Ønt. / Inn. Ø 65m		
7	30/306-2	1004633M1	Joint toriq / O-ring	Ø.2m		
8	30/308-2	532888M2	Protection / House	Ø9m 3ème série / 3rd series		

Les références des pièces sont indicatives.
Nos pièces ne sont pas d'origine

Part numbers are quoted for reference purposes only.
Our parts and accessories are not original.



**PRISE DE FORCE
PTO**

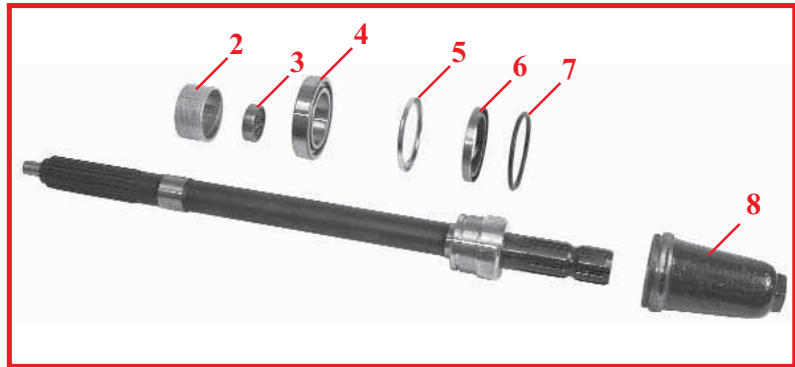
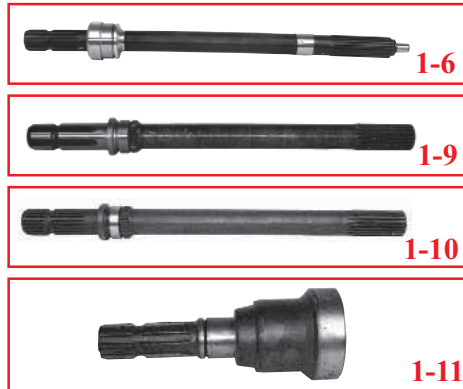

Tracteurs Tractors	Fig.	Réf. Ref.	OEM	Description	Observation
340, 342, 352, 362	1-6	30/303-16	1660288M91	Arbe-1 vitesse-540 T/m Shaft-1 speed-540 RPM 3 ^{ème} série / 3rd series	L : 615m A : 1 3/8" 6Z B : 1 3/8" 21Z C : Ø0m
	3	30/302-1	195453M1	Robant / Bearing	1 3/8" x 1 5/8" x 1 1/2"
	4	30/304-3	391162X1	Robant / Bearing	50 x 80 x 20 m
	6	30/305-22	3699801M1	Baga / PTO oil seal	50x80.6
	8	30/308-2	532888M2	Protection / House	Ø9m
362, 365, 375, 382N, 390, 398 399 (1006.6)	1-9	30/303-36	3611482M2	Arbe-2 vitesses-540 T/m Shaft-2 speeds-540 RPM PTO indépendante Independent PTO	L : 508m A : 1 3/8" 6Z B : 1 3/8" 21Z
	1-10	30/303-37	3611493M2	Arbe-2 vitesses-1000 T/m Shaft-2 speeds-1000 RPM PTO indépendante Independent PTO	L : 508 A : 1 3/8" 21Z B : 1 3/8" 21Z
	4	30/304-3	391162X1	Robant / Bearing	50 x 80 x 20 m
	6	30/305-22	3699801M1	Baga / PTO oil seal	50x80.6
	8	30/308-2	532888M2	Protection / House	Ø9m
592, 595	1-11	30/303-91	518529M1	Adaptaten PTO PTO adapter	L : 232 A : 1 3/8" 6Z B : 36Z
Séries 4200, 4300 series	4	30/304-3	391162X1	Robant / Bearing	50 x 80 x 20 m
	6	30/305-22	3699801M1	Baga / PTO oil seal	50x80.6

Les références des pièces sont indicatives.
Nos pièces ne sont pas d'origine

Part numbers are quoted for reference purposes only.
Our parts and accessories are not original.



PRISE DE FORCE
PTO

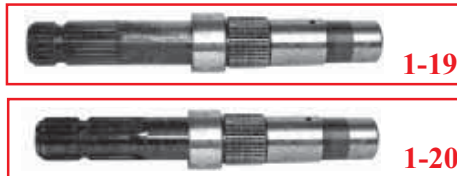
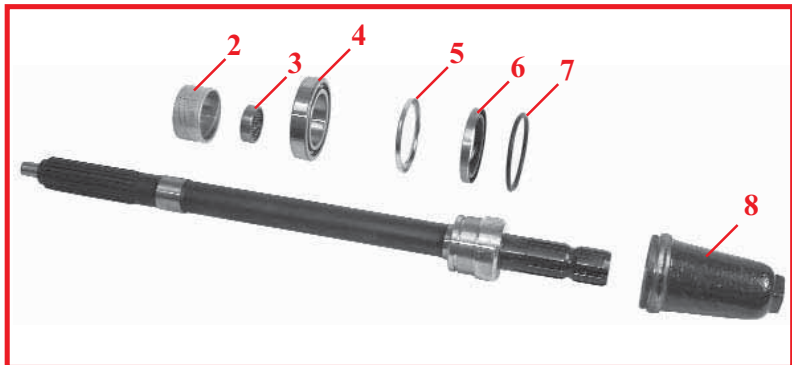
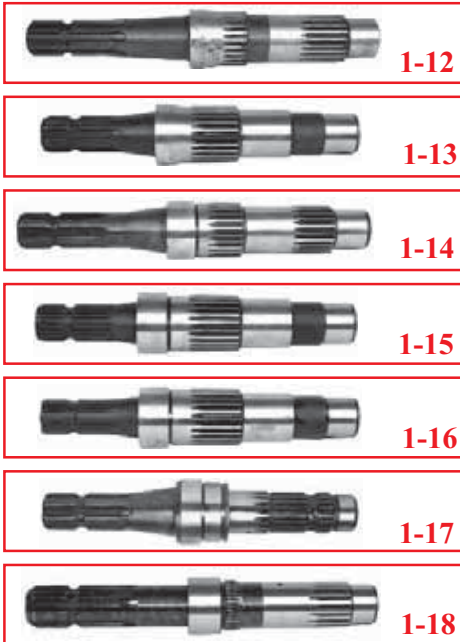

Tracteurs Tractors	Fig.	Réf. Ref.	OEM	Description	Observation
2620, 2640, 2680, 2720	1-12	30/303-92	3042960M2	540 T/in / 540 RPM Fixation écrou / Nut fitting	L :345m A :1 3/8" 6Z
	1-13	30/303-93	3042961M1	1000 T/in / 1000 RPM Fixation écrou / Nut fitting	L :295m A :1 3/8" 6Z
	5	30/305-23	1610254M1	O Ring	
	6	30/305-24	3383568M1	Bague / PTO oil seal	
2620, 2625, 2640, 2645, 2680, 2685, 2720, 2725, 3610, 3630, 3635, 3645, 3650, 3655, 3670, 3680, 3690, 8110, 8120, 8130, 8140, 8150, 8160	1-14	30/303-94	3321752M9	540 T/in / 540 RPM Fixation clips / Pins fitting	L :350m A :1 3/8" 6Z
	1-15	30/303-45	3321750M8	1000 T/in / 1000 RPM Fixation clips / Pins fitting	L :295m A :1 3/8" 21Z
	1-16	30/303-46	3583342M6	1000 T/in / 1000 RPM Fixation clips / Pins fitting	L :295m A :1 3/8" 6Z
	5	30/305-23	1610254M1	O Ring	
3050, 3060, 3065, 3070, 3075, 3080, 3085, 3090, 3095, 3115, 3120, 3125, 6110, 6120, 6130, 6140, 6150, 6160, 6170, 6180, 6190, 6235, 6245, 6255, 6260, 6265, 6270, 6280, 6290	6	30/305-24	3383568M1	Bague / PTO oil seal	
	1-17	30/303-44	3382074M10	540/1000 T/in / RPM Crabtab / 2 speed	L :289m A :1 3/8" 6Z
	4	30/304-2	391261X1	Robent / Bearing	55 x 90 x 18
	6	30/305-7	834216M1	Bague / PTO oil seal	Øht. / Inn. Ø 60mm
	5	30/305-8	533183M1	Joint / Seal	Øht. / Inn. Ø 65m
3050, 3060, 3065, 3070, 3075, 3080, 3085, 3090, 3095, 3115, 3120, 3125, 6110, 6120, 6130, 6140, 6150, 6160, 6170, 6180, 6190, 6235, 6245, 6255, 6260, 6265, 6270, 6280, 6290	1-18	30/303-62	3382073M7	540 T/in / 540 RPM Démntab / Removable	L :287m A :1 3/8" 6Z
	1-19	30/303-64	3382072M7	1000 T/in / 1000 RPM Démntab / Removable	L :287m A :1 3/8" 21Z
	1-20	30/303-101		1000 T/in / 1000 RPM Démntab / Removable	L :287m A :1 3/8" 6Z
	4	30/304-2	391261X1	Robent / Bearing	55 x 90 x 18
	6	30/305-7	834216M1	Bague / PTO oil seal	Øht. / Inn. Ø 60mm
	5	30/305-8	533183M1	Joint / Seal	Øht. / Inn. Ø 65m

Les références des pièces sont indicatives.
Nos pièces ne sont pas d'origine

Part numbers are quoted for reference purposes only.
Our parts and accessories are not original.



**PRISE DE FORCE
PTO**

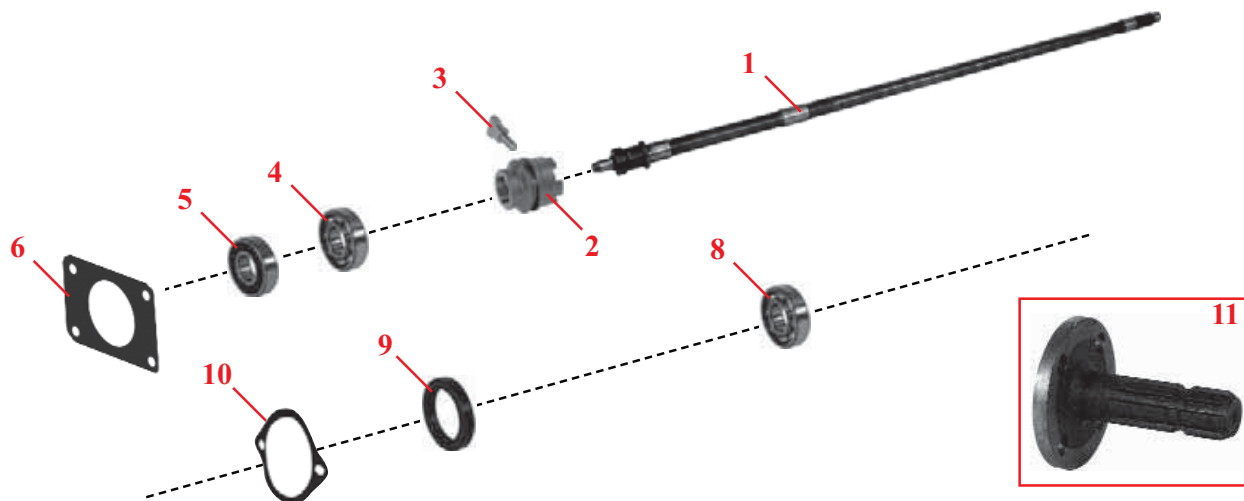

Tracteurs Tractors	Fig.	Réf. Ref.	OEM	Description	Observation
IT Tracteurs italiens / Italian tractors					
154, 174, 184, 194	1	30/303-12	1423679M3	Arbre / Shaft	
	2	30/301-6	1423682M3	Manchon / Sleeve	
	3	30/6683-16	974436M1	Levier / Lever	
	4	30/304-19	339436X1	Roulement / Bearing	35 x 80 x 21m
	5	30/304-18	1440559X1	Roulement / Bearing	
	6	78/9604-130	1825006M1	Joint / Gasket	
134, 154, 164, 174, 184, 194, 233, 234, 244CF, 253, 254, 263, 264, 273, 274, 283, 284, 293, 294, 333, 334V, 353, 354, 356CF, 363, 364, 366, 367CF, 373, 374, 376, 377, 383, 384, 387, 393, 394, 396, 397, 3210, 3220, 3225, 3235	7	30/303-77	3543737M3	Arbre / Shaft	
	8	30/304-19	339436X1	Roulement avec sécurité 195284M1 Bearing with safety 195284M1	35 x 80 x 21m
	9	30/305-21	3306228M1	Bague / Bush	50 x 70 x 10m
	10	30/306-8	1825004M1	Joint / Gasket	
1014, 1024, 1114, 1134	11	30/303-82	1427342M1	Arbre / Shaft	1 3/8" 6Z

Les références des pièces sont indicatives.
Nos pièces ne sont pas d'origine

Part numbers are quoted for reference purposes only.
Our parts and accessories are not original.



**PRISE DE FORCE INDEPENDANTE (IPTO)
INDEPENDENT P.T.O. GEAR**

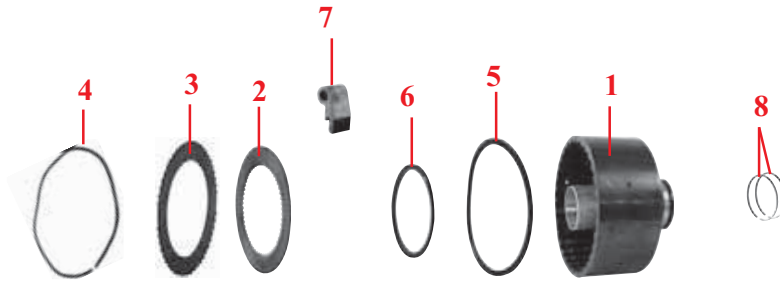

Tracteurs Tractors	Fig.	Réf. Ref.	OEM	Description
135, 148, 152, 155, 158, 158MKIII, 158 F/S/V, 165, 168, 168MKIII, 168 F/S, 185, 188, 240, 250, 253, 260, 263, 265, 275, 285, 290, 340, 350, 355, 360, 362, 365, 375, 390, 396, 398, 399, 550, 560, 565, 575, 590, 592, 595, 595MKII, 675, 690, 698, 699, 1004, 1200, 1250	1	30/310-5	1870004M92	Carter / housing
	2	30/317-1	1672626M1	Disq de friction (7 par tracten) Friction disc (7 per tractor) Ø28m57Z - 88x94m
	3	30/316-1	513242M1, 1870860M1	Disq intermédiaire (7 par tracten) Intermediate disc (7 per tractor) Ø44m32Z
	4	30/321-1	3795274M1	Ressort (7 par tracten) Spring (7 per tractor)
	5	30/312-2	1870859M1	Joint de piston extérieur Outer cylinder gasket
	6	30/311-2	1870858M1	Joint de piston intérieur Inner cylinder gasket
	7	30/393-1	1662242M2	Levier de commande Brake pad
	8	30/318-3	1866260M1	Segment Sealing ring
342, 352, 362, 365, 372N, 375, 382N, 390, 398, 399, 699 (PTO 2 vitesses / Gear)	2	30/317-8	1686359M1	Disq de friction / Friction disc Ø28m57Z - 88x94m
4215, 4220, 4225, 4235, 4240, 4245, 4255, 4265, 4315, 4320, 4325, 4335, 4345, 4355	3	30/316-1	1870860M1	Disq intermédiaire / Intermediate disc Ø44m32Z
	5	30/312-2	1870859M1	Joint de piston extérieur Outer cylinder gasket
Industriel/ Industrial 20, 30, 40, 50	2	30/317-1	1870879M1	Disq de friction / Friction disc Ø28m57Z - 88x94m
	3	30/316-1	1870860M1	Disq intermédiaire / Intermediate disc Ø44m32Z
Industriel/ Industrial	2	30/317-8	1686359M1	Disq de friction / Friction disc Ø28m57Z - 88x94m
	3	30/316-6	1692157M1	Disq intermédiaire / Intermediate disc Ø44m27Z

IPTO complète / Complete IPTO

250, 260, 265, 275, 285, 290, 298, 355, 360, 362, 365, 375, 390, 390T, 396, 398, 399, 550, 565, 575, 590, 675, 690, 698, 699, 1004

30/300-1
(1660842M98)

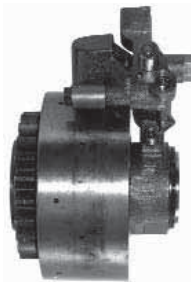

Les références des pièces sont indicatives.
Nos pièces ne sont pas d'origine

Part numbers are quoted for reference purposes only.
Our parts and accessories are not original.



**BOITIER CENTRAL
CENTRE HOUSING**

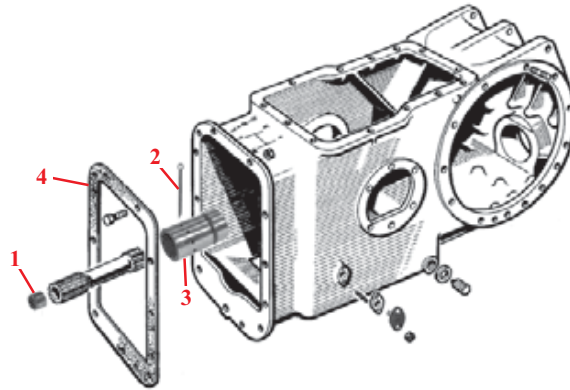

Fig.	1	2	3		4
Tracteurs Tractors	Roul. à aiguilles Needle bearing	Goupille fendue Cotter pin	Manchon Drive coupling	Manchon Drive coupling	Joint Gasket
35, 835	30/325-1 (195513M1)	30/329-1 (354416X1, 3701695M1)	30/330-1 (880069M2)		30/331-1 (3599804M2)
65, 765, 865			2 rain. / 2 groove 30/330-1 (880069M2)	3 rain. / 3 groove 30/330-2 (880070M2)	
133, 135, 140, 145, 148			54 x 127 m 30/330-1 (880069M2)	54 x 97 m 30/330-3 (1871924M1)	
152, 155, 158			30/330-4 (1680189M1)		
165, 168, 185, 188			54 x 127 m 30/330-2 (880070M2)	57 x 97 m 30/330-4 (1680189M1)	
175, 178			30/330-2 (880070M2)		
230, 235, 245			30/330-3 (1871924M1)		
240, 250, 265, 350, 355, 360, 362, 365			(⇒ B32999) 54 x 97 m 30/330-3 (1871924M1)	(⇒ B32999) 57 x 97 m 30/330-4 (1680189M1) (B33001 ⇒) 57 x 84 m 30/330-6 (3611473M1)	
243, 253, 255, 263, 275, 275E, 285, 290, 290E, 298, 340, 342, 352, 375, 375E, 390, 390E, 390T, 396, 398, 399			(⇒ B32999) 54 x 97 m 30/330-3 (1871924M1)	(B33001 ⇒) 57 x 84 m 30/330-6 (3611473M1)	
550			30/330-3 (1871924M1)		
560, 565, 575, 590, 675, 690			30/330-4 (1680189M1)		
592, 595, 595MKII, 1080, 1085					
698, 698T, 699, 1004, 1004T			30/330-4 (1680189M1)		
1200, 1250			54 x 127 m 30/330-2 (880070M2)	57 x 97 m 30/330-4 (1680189M1)	
4215, 4220, 4225, 4235, 4240, 4245, 4255, 4260, 4265, 4270, 4315, 4320, 4325, 4335, 4345, 4355, 4360, 4365, 4370			Marchepied 2RM Footstep 2WD 30/325-1 (195513M1)		

Les références des pièces sont indicatives.
Nos pièces ne sont pas d'origine

Part numbers are quoted for reference purposes only.
Our parts and accessories are not original.



**BOITIER CENTRAL
CENTRE HOUSING**

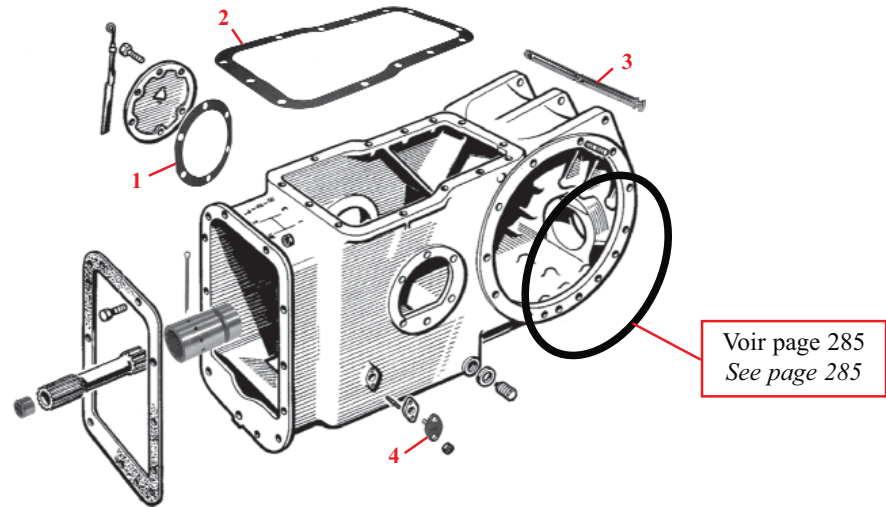

Fig.	1	2	3	4		
Tracteurs Tractors	Joint Gasket	Joint Gasket	Broche Hinge pin	Support Support pin	Support Support pin	
35, 835, 865 65, 765 (⇒ 609713)	30/332-1 (181217M3)	Ep. 0.45m Th. 30/333-1 (181408M1)	30/334-1 (180901M91)	30/336-1 (180905M1)		
65, 765 (609714 ⇒), 135 (⇒ 106718), 175, 178 (⇒ 731775)		Ep. 0.16m Th. 30/333-2 (886549M2)				
135 (106719 ⇒) 133, 140, 145, 148, 152, 155, 158						
165, 168, 185, 188 175, 178 (731776 ⇒)					30/336-2 (898643M1)	30/336-3 (898937M1)
230, 235, 243, 245, 255, 285, 298	Ep. 0.86m Th. 30/332-1 (181217M3)	30/333-2 (886549M2) ou or Loctite®				
240, 250, 253, 263, 265, 275, 290	Ep. 1.5m Th. 30/332-2 (1688222M3)	78/9604-130 (3900613M2)				30/336-3 (898937M1)
275E, 290E, 375E, 390E	30/332-2 (1688222M3)	Loctite® 78/9604-130 (3900613M2)				
340, 342, 350, 352, 355, 360, 362, 362N, 365, 372N, 375, 382N, 390, 390T, 396, 398, 399	30/332-1 (181217M3)	30/333-2 (886549M2)			30/336-2 (898643M1)	30/336-3 (898937M1)
550						
560, 565, 575, 590						
592, 595, 595MKII, 1080, 1085						
675, 690, 698, 698T, 699, 1004, 1004T		30/333-2 (886549M2)				
1200, 1250						
4215, 4220, 4225, 4235, 4240, 4245, 4255, 4260, 4265, 4270		Loctite® 78/9604-130 (3900613M2)	30/334-1 (180901M91)			
4315, 4320, 4325, 4335, 4345, 4355, 4360, 4365, 4370						

Les références des pièces sont indicatives.
Nos pièces ne sont pas d'origine

Part numbers are quoted for reference purposes only.
Our parts and accessories are not original.



"THE RELIABLE SERVICE"



DIFFERENTIEL - COUPLE CONIQUE
DIFFERENTIAL - CROWN WHEEL & PINION

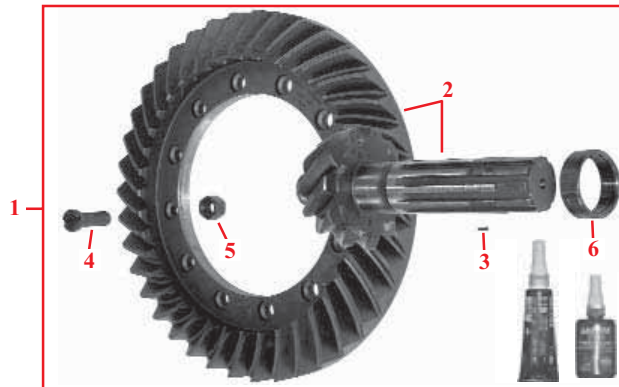

Fig.	1	2	3	4	5	6
Tracteurs Tractors	Kit couple con. Crown wh. kit	Couple con. Wheel & pinion	Galet Needle roller	Vis Bolt	Ecrou Nut	Ecrou pignon Pinion nut
Tracteurs français, anglais, américains / French, UK, USA tractors						
TEA20, TED20, TEF20, TEH20						
35 133, 135, 140 (Preîrs / Early 6 x 37)	30/340-1 (A) (1885317M92)	30/341-1 (A) (182115M91)				
133, 135, 140 (Derniers / Late 6 x 37) 135V, 145V	30/340-3 (B) (1683757M91)	30/341-3 (B) (B3413)				
65, 765, 865 135, 145, 148 (MKIII France - 11 x 38) 152, 155, 158, 165, 168, 175, 178, 185, 188	30/340-4 (1664255M92)	30/341-4 (184382M92)				30/346-1 (532956M1)
148 (UK)						
230, 240 (6 x 37 - ⇒ B32999) 235, 245, 250 (6 x 37)	30/340-3 (1683757M91)	30/341-3 (B3413)				
230, 240 (6 x 37 - B33001 ⇒)						
240, 250, 255, 260, 265, 275, 285, 290 (11 x 38) 253, 275E, 290E (11 x 38 - ⇒ B32999)	30/340-4 (1664255M92)	30/341-4 (184382M92)				30/346-1 (C) (532956M1)
243, 263 253, 275E, 290E (11 x 38 - B33001 ⇒)						
275, 285, 290, 290E, 298 (9 x 35 & 0 x 39)			30/339-1 (831485M1)	30/342-1 (825776M1)	30/343-1 (891947M1)	
340 (6 x 37)	30/340-3 (1683757M91)	30/341-3 (B3413)				30/346-1 (532956M1)
342 (6 x 37)						
350, 355, 360 (11 x 38) 362, 365, 375, 375E, 390, 390E, 399 (11 x 38 - ⇒ B32999)	30/340-4 (1664255M92)	30/341-4 (184382M92)				30/346-1 (C) (532956M1)
350, 352, 355, 360, 362, 365, 375, 390, 390T, 396 (8 x 35)						
352, 362N, 372N, 382N, 390T, 396, 398 (11 x 38) 362, 365, 375, 375E, 390, 390E, 399 (11 x 38 - B33001 ⇒)						Ep. 17m Th. 30/346-1 (532956M1)
375, 390, 390E, 398, 399 (9 x 35)						
550						
560, 565, 575, 590, 675, 690 (11 x 38)	30/340-4 (1664255M92)	30/341-4 (184382M92)				30/346-1 (532956M1)
575, 590, 675, 690, 698, 698T, 699, 1004, 1004T (9 x 35 & 0 x 39)						

(A) Pignon 236.5 m Pinion

(B) Pignon 250.9 m Pinion

(C) Sans copten de vitesse / Without Speedo

Les références des pièces sont indicatives.

Nos pièces ne sont pas d'origine

Part numbers are quoted for reference purposes only.

Our parts and accessories are not original.



DIFFERENTIEL - COUPLE CONIQUE
DIFFERENTIAL - CROWN WHEEL & PINION

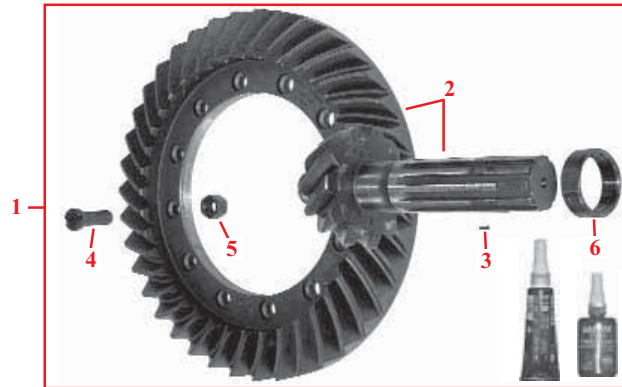

Fig.	1	2	3	4	5	6
Tracteurs Tractors	Kit couple con. Crown wh. kit	Couple con. Wheel & pinion	Galet Needle roller	Vis Bolt	Ecrou Nut	Ecrou pignon Pinion nut
Tracteurs français, anglais, américains / French, UK, USA tractors						
592, 595, 595MKII, 1080, 1085			30/339-1 (831485M1)			30/346-1 (532956M1)
1200, 1250						
Séries 2600, 2700, 3000, 3100, 3600, 6100, 6200, 8100, 8200 series				30/342-1 (825776M1)	30/343-1 (891947M1)	
Séries 4200, 4300 series			30/339-1 (831485M1)			Ep. 17m Th. 30/346-1 (532956M1)
Tracteurs italiens / Italian tractors						
154, 174, 184, 194, 234S, 284S (Transmission standard et synchronisée - 8 x 39 Standard and synchromesh transmission - 8 x 39)		30/341-23 (1424422M91)				
154S, 174S, 184S, 254, 254S, 274, 274S, 294S (Premières transmissions synchronisées - 8 x 39 Early synchromesh transmission - 8 x 39)						
154S, 174S, 184S, 254, 254S, 274, 274S, 294S (Dernières transmissions synchronisées - 8 x 39 Late synchromesh transmission - 8 x 39)						30/346-10 (1423748M1)
134V, 154 F/V, 164T F/S/V, 174 F/V, 233, 253, 273, 274SK, 283, 284, 293, 294 (Transmission synchronisée - 8 x 39 Synchromesh transmission - 8 x 39)						
184 F/S, 194 F/S, 263T, 264T, 264TS (Transmission synchronisée - 8 x 43 Synchromesh transmission - 8 x 43)						

Les références des pièces sont indicatives.
Nos pièces ne sont pas d'origine

Part numbers are quoted for reference purposes only.
Our parts and accessories are not original.



"THE RELIABLE SERVICE"



**DIFFERENTIEL
DIFFERENTIAL**

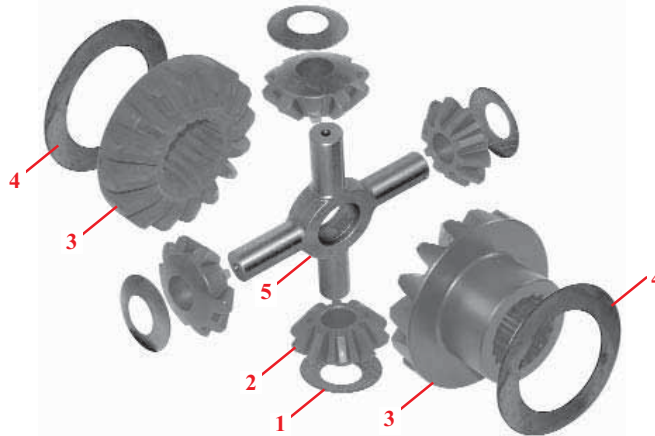

Fig.	1	2	3	4	5	
Tracteurs Tractors	Rondelle Thrust washer	Pignon diff. Diff. pinion	Pignon du différentiel Differential gear	Rondelle Thrust washer	Croisillon Cross joint	
35 (UK) (Sans bçage différentiel ⇒ 383987 Without differential lock ⇒ 383987) 35 (UK), 65, 765, 865 (Avec bçage différentiel With differential lock)	30/347-2 (3387281M1)	Øxt. 75 m out. Ø 75 mm 30/348-1 (181275M1)	Prof. 66 m Depth 66 mm 30/349-1 (LH) (181249M3)	Ep.: 2 m Th.: 2 mm 30/350-1 (181247M1)	30/351-1 (2746135M2)	
35 (France), 835 65, 765, 865 (Sans bçage différentiel Without differential lock)			Prof. 49 m Depth 49 mm 30/349-2 (RH) (184700M1)			
35 (UK) (Sans bçage différentiel 383988 ⇒ Without differential lock 383988 ⇒) 133, 135, 140, 145, 165, 175, 178 (Précis / Early)			16 dents x 19 cannettes 16 teeth x 19 spline 30/349-1 (181249M3)			
133, 135, 140, 145, 165, 175, 178 (Derniers / Late) 148, 152, 155, 158, 168, 185, 188		16 dents x 39 cannettes 16 teeth x 39 spline 30/349-3 (897006M1)				
Séries 200, 300, 500, 600, 1000, 2600, 2700, 4200, 4300 series 1200, 1250		Øxt. 85 m out. Ø 85 mm 30/348-2 (2746322M1)	14 dents x 39 cannettes 14 teeth x 39 spline 30/349-5 (885518M5)			Ep.: 1.6 m Th.: 1.6 mm 30/350-2 (897726M1)
Séries 3000, 3100, 3600, 6100, 6200 series 8110, 8120, 8130, 8140, 8150, 8160, 8210, 8220, 8240, 8250 (Avec bçage hydro-mécanique With hydromechanical lock)						

Les références des pièces sont indicatives.
Nos pièces ne sont pas d'origine

Part numbers are quoted for reference purposes only.
Our parts and accessories are not original.



"THE RELIABLE SERVICE"



**DIFFERENTIEL
DIFFERENTIAL**

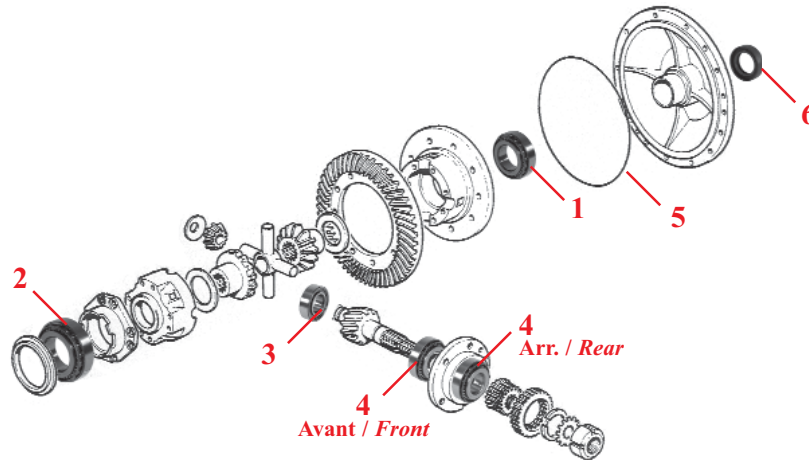

	1	2	3	4	5	6
Tracteurs Tractors	Roulement G Bearing LH	Roulement D Bearing RH	Roulement Pinion bearing	Roulement Sleeve bearing	Joint Gasket	Bague Oil seal
Tracteurs français, anglais & américains / French, UK & USA tractors						
TEA20, TED20, TEF20, TEH20	30/352-3 (1851533M91)					
35, 135, 835 Sans cage d'ailiff. / Without diff. lock					30/357-1 (183254M1)	
65, 165, 765, 865 Sans cage d'ailiff. / Without diff. lock	30/352-1 (1852157M91)			30/354-1 (1850090M92)		
35, 135, 835 Avec cage d'ailiff. / With diff. lock						
133, 135, 140, 230, 235, 240, 245, 250, 340, 835 Frein à tambour / Single brake drum						
148 (UK), 550 Frein à tambour / Single brake drum	30/352-3 (1851533M91)			30/353-1 (191250M1)	Joint Gasket 30/357-1 (183254M1)	30/358-1 (832954M3)
65, 165, 765, 865 Avec cage d'ailiff. / With diff. lock						
133, 135, 140 Frein sec / Dry brake						
145, 152, 155, 158, 168, 175, 178, 185, 188						
135, 145, 148, 152, 158, 168 Modèles MKIII France / MKIII models France						
240, 250, 340 Frein mouillé / Wet brake	1er / Early 67x113x30m 30/352-3 (1851533M91)		30/352-2 (1850909M91)		30/354-1 (1850090M92)	
243, 253, 260, 263, 265, 275E, 342, 350, 352, 355, 360, 362, 362N, 365, 372N, 375E, 382N, 390T, 560						
275, 290, 290E, 375, 390, 390E, 398, 575, 590, 675, 690 (11x38)	Demier / Late 73x113x25m 30/372-24 (1860503M93)					
275, 290, 290E, 375, 390, 390E, 398, 575, 590, 675, 690 (9x35 & 0x39)						
298, 399, 698, 698T, 699, 1004, 1004T				30/353-20 (834733M1)	Avt. / Front 30/354-25 (3405341M91) Arr. / Rear 30/354-26 (3405342M91)	
1080, 1085					30/357-2 (1860838M1)	
1200, 1250	30/352-3 (1851533M91)			30/353-1 (191250M1)	Avt. / Front 30/354-2 (1868353M91) Arr. / Rear 30/354-3 (1868354M91)	30/358-1 (832954M3)

Les références des pièces sont indicatives.
Nos pièces ne sont pas d'origine

Part numbers are quoted for reference purposes only.
Our parts and accessories are not original.



"THE RELIABLE SERVICE"



**DIFFÉRENTIEL
DIFFERENTIAL**

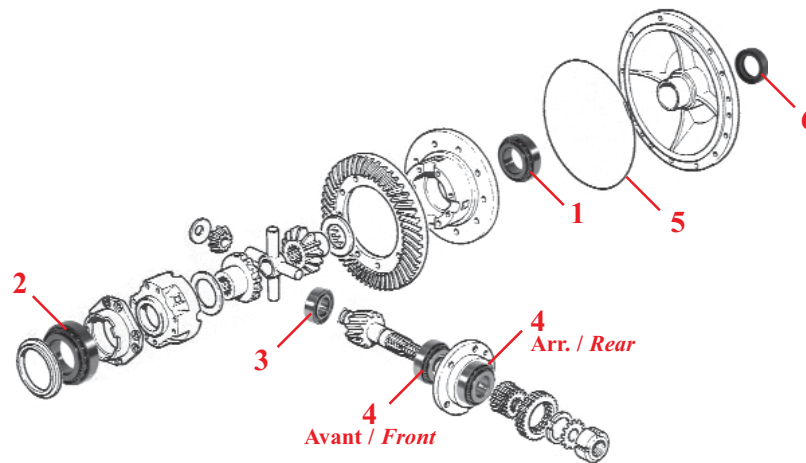

Tracteurs Tractors	1 Roulement G Bearing LH	2 Roulement D Bearing RH	3 Roulement Pinion bearing	4 Roulement Sleeve bearing	5 Joint Gasket	6 Bague Oil seal
Tracteurs français, anglais & américains / French, UK & USA tractors						
2620, 2625, 2640, 2645, 2680, 2685, 2720, 2725	30/352-3 (1851533M91)	30/352-2 (1850909M91)	30/353-21 (3405249M91)	30/354-27 (3009106X91)		
2675, 2705, 2745, 2775, 2805	30/372-4 (1881931M91)	30/352-19 (771130M1+ 771150M1)	30/353-22 (1612571M1+ 22246X)	30/354-28 (1612560M1+ 1612561M1)	78/9604-130 (3900613M2)	
3050, 3060, 3065, 3070, 3075, 3080, 3085, 3090, 3095, 3115, 3120, 3120T, 3125, 3140	30/352-3 (1851533M91)		30/354-21 (1440637X1)	30/354-29 (3011321X91)		
3610, 3630, 3635, 3645, 3650, 3655, 3660, 3670, 3680, 3690				30/353-21 (3405249M91)	30/354-27 (3009106X91)	
4215, 4220, 4225, 4235, 4240, 4315, 4320 4245, 4255, 4260, 4265, 4270, 4345, 4355, 4360, 4365, 4370 <i>(11x38)</i>			30/353-1 (191250M1)	30/354-1 (1850090M92)		
4245, 4255, 4260, 4265, 4270, 4345, 4355, 4360, 4365, 4370 <i>(9x35)</i>	30/372-24 (1860503M93)		30/353-20 (834733M1)	<i>Avt. / Front</i> 30/354-25 (3405341M91) <i>Arr. / Rear</i> 30/354-26 (3405342M91)	30/357-2 (1860838M1)	
6110, 6120, 6130, 6140, 6150, 6160, 6170, 6180 6190			30/352-2 (1850909M91)	30/354-21 (1440637X1)		
6235, 6245, 6255, 6260, 6265, 6270 (<i>⇒ J325024</i>) 6280 (<i>⇒ J320011</i>)	30/352-3 (1851533M91)		30/353-23 (3791085M91)	30/354-29 (3011321X91)		
6235, 6245, 6255, 6260, 6265, 6270 (<i>J325025⇒</i>) 6280 (<i>J320012 ⇒</i>), 6290					30/354-21 (1440637X1)	
8110, 8120, 8130, 8140, 8150, 8160				30/353-23 (3791085M91)		
8170, 8180	30/352-18 (3010714X91, 3010538X91)		30/353-21 (3405249M91)	30/354-27 (3009106X91)	78/9604-130 (3900613M2)	
8210, 8220, 8240, 8250 <i>Différentiel 5" 5" differential</i>	30/352-3 (1851533M91)	<i>Hidromach</i> 30/352-2 (1850909M91)		<i>Avt. / Front</i> 30/354-30 (3010735X91)		
		<i>Midisc</i> 30/352-20 (3010726X91)		<i>Arr. / Rear</i> 30/354-31 (3010720X91)		
8210, 8220, 8240, 8250 <i>Différentiel 7" 7" differential</i> 8260, 8270, 8280	30/352-18 (3010714X91, 3010538X91)	30/352-2 (1850909M91)				

Les références des pièces sont indicatives.
Nos pièces ne sont pas d'origine

Part numbers are quoted for reference purposes only.
Our parts and accessories are not original.



**DIFFERENTIEL
DIFFERENTIAL**

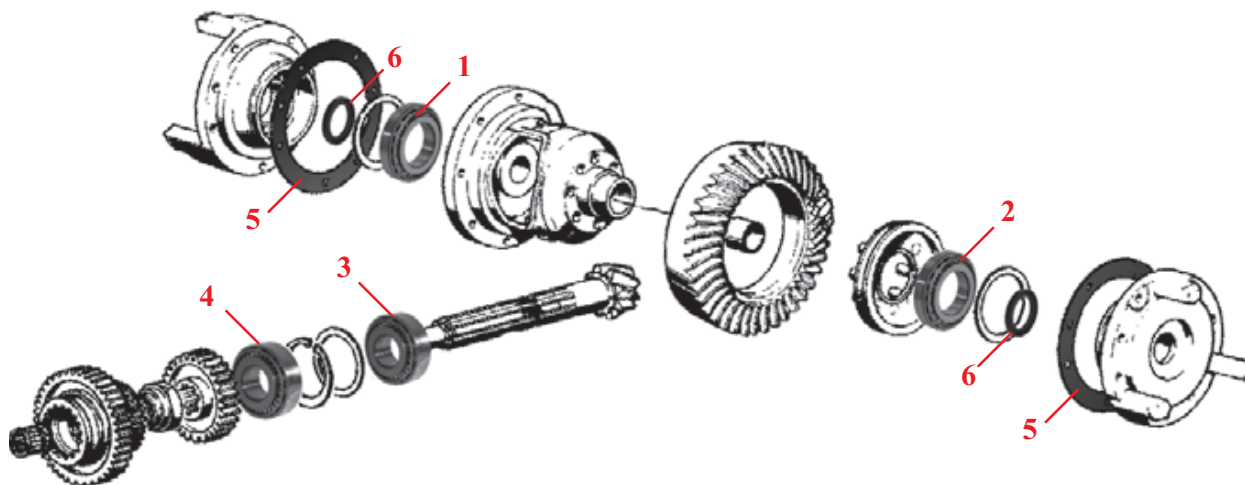

	1	2	3	4	5	6
Tracteurs Tractors	Roulement G Bearing LH	Roulement D Bearing RH	Roulement Front bearing	Roulement Rear bearing	Joint Gasket	Bague Oil seal
IT Tracteurs italiens à roues / Italian wheeled tractors						
154, 174, 184, 194, 234S, 284S 154S, 174S, 184S, 254, 254S, 274, 274S, 294S <i>Frein sec / Dry brake</i>	30/352-11 (330376X1)		30/353-12 (3304822M91)	30/354-16 (1440640X1)	30/357-4 (1824683M2)	30/358-2 (395563X1)
154S, 174S, 184S, 254, 254S, 274, 274S, 294S <i>Frein positif / Wet brake</i>					30/357-5 (3304650M1)	
134V, 154F/V, 164T F/S/V, 174F/V, 233, 253, 263T, 264T/TS, 273, 274SK, 283, 284, 293, 294						
333, 334V, 353, 354, 363, 364, 373, 374, 377, 383, 384, 387, 393, 394, 397, 397T, 1007 <i>Totundèts / All models</i>			30/353-24 (3532345M91)			
1104	30/352-13 (1440651X1)	30/352-16 (391339X1)	30/354-32 (1440639X1)			30/358-6 (3305773M1)
2205, 2210, 2220	Ext. G ⌀ Outer LH & RH 30/352-15 (3009853X1)	Int. / Inner 30/352-21 (1441835X1)	30/353-25 (3537271M1)	30/353-26 (3537270M1)	30/357-6 (378246X1)	
2225, 2230, 2235		Int. / Inner 30/352-22 (3015405X1)			+	30/357-7 (378249X1)

Les références des pièces sont indicatives.
Nos pièces ne sont pas d'origine

Part numbers are quoted for reference purposes only.
Our parts and accessories are not original.



**DIFFERENTIEL
DIFFERENTIAL**

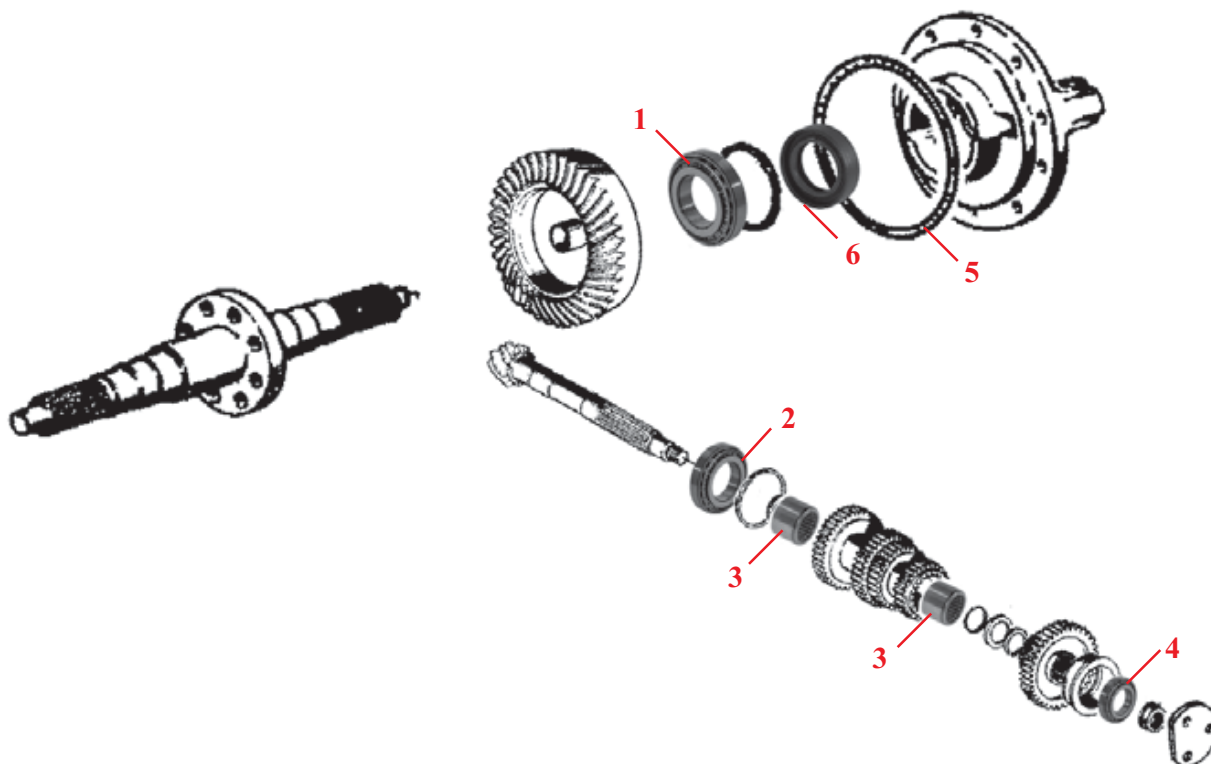

	1	2	3	4	5	6
Tracteurs Tractors	Roulement G&D Bearing LH&RH	Roulement avt. Front bearing	Roulement central Centre bearing	Roulement arr. Rear bearing	Joint Gasket	Bague Oil seal
IT Tracteurs italiens à chenilles / Italian crawler tractors						
134C, 154C, 174C	30/352-23 (1442008X1)	30/353-24 (3532345M91)			30/357-4 (1824683M2)	30/358-6 (3305773M1)
194C	30/352-24 (1440644X1)	30/353-27 (392513X1)			30/357-8 (394881X1)	30/358-7 (391346X1)
234C/CF, 244CF, 254C/CF, 264TCF, 274C/CF	30/352-23 (1442008X1)	30/353-24 (3532345M91)	30/354-33 (1442538X1)	30/353-11 (390876X1)	Joint / Gasket 30/357-4 (1824683M2) O ring 30/357-9 (3052593M2)	30/358-6 (3305773M1)
294C, 394C	30/352-24 (1440644X1)	30/353-27 (392513X1)			30/357-9 (3052593M2)	30/358-8 (3308686M1)
356CF, 364CF, 366CF, 367CF						30/358-6 (3305773M1)
376C/CF/XCF, 396C/CF/CT	30/352-23 (1442008X1)	30/353-24 (3532345M91)			30/357-10 (3545945M1)	

Les références des pièces sont indicatives.
Nos pièces ne sont pas d'origine

Part numbers are quoted for reference purposes only.
Our parts and accessories are not original.



"THE RELIABLE SERVICE"



**PONT ARRIERE
REAR AXLE**

Arbre transmission directe / Direct drive axles

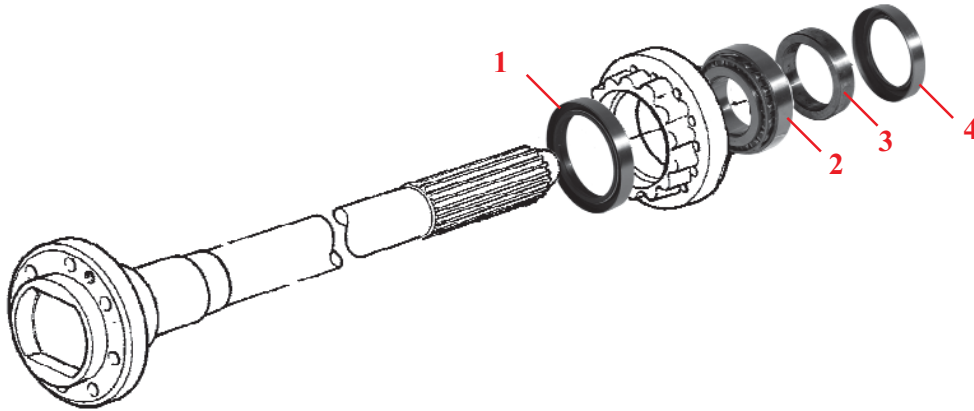

Tracteurs Tractors	1 Bague Outer seal	2 Roulement Bearing	3 Bague Collar	4 Bague Inner seal
Tracteurs français, anglais & américains / French, UK & USA tractors				
TEA20, TED20, TEF20, TEH20	30/371-19 (890640M1)	30/372-35 (952400M1)	30/375-3 (890543M1)	325001 ⇔ 30/376-11 (104628)
35, 835	30/371-1 (195677M1)	30/372-1 (1850088M91)	30/375-1 (180596M1)	30/376-1 (195678M2)
133, 135, 140, 148, 230, 245, 550 240, 250, 340 Frein simple tambour / <i>Single drum brakes</i>		30/372-36 (3612310M1 + 3611776M1)		
340 Frein sous treuil / <i>Wet brake</i>				
240, 340 Frein sous treuil - Transmission direct 63" <i>Wet brake - 63" direct drive</i>	30/371-30 (3698907M1)	30/372-37 (3697992M1)		
342				
Tracteurs industriels / Industrial tractors				
702	30/371-1 (195677M1)	30/372-1 (1850088M91)	30/375-1 (180596M1)	30/376-1 (195678M2)
20B, 20D, 2135				

Les références des pièces sont indicatives.
Nos pièces ne sont pas d'origine

Part numbers are quoted for reference purposes only.
Our parts and accessories are not original.



**PONT ARRIERE
REAR AXLE**

Arbres épicycliques (Freins à disque) / Epicyclic axles (Disc brakes)

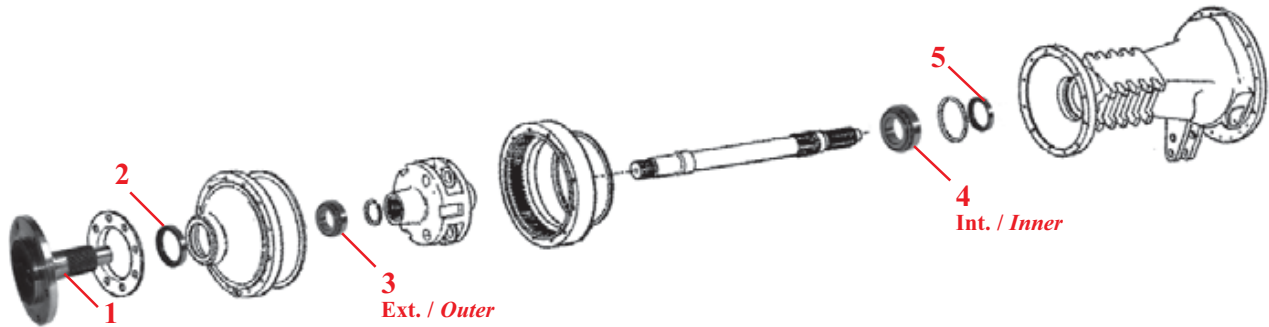

Tracteurs Tractors	1 Arbre Axle shaft	2 Bague Outer seal	3 Roulement ext. Outer Bearing	4 Roulement int. Inner bearing	5 Bague int. Inner seal
Tracteurs français, anglais & américains / French, UK & USA tractors					
65, 765, 865 133, 135, 140 (Étroit - Abagne / Narrow - Germany) 145, 152, 155, 158 (Étroit / Narrow)		30/371-2 (966238M1)	30/372-3 (1851392M91)	30/372-3 (1851392M91)	30/376-2 (881991M1)
133, 135, 140 (Std - Abagne / Std - Germany) 135 (Verger - américain / Orchard - USA) 145, 152, 155, 158 (Std / Std) 165, 168, 175, 178, 185, 188 Freins sec / Dry brakes	30/370-4 (884850M3)		30/372-3 (1851392M91)		30/376-3 (894782M2)
135, 145, 148, 152, 158, 168 (France) Modèles MKIII F/V/S models					S & 30/376-15 (1660905M1)
165, 168, 188 185 (Std / Normal duty) Frein positif / Wet brakes					30/376-4 (1860954M1)
185 (Renforcé / Heavy duty)		Preins Boitier metal Early Metal cased 30/371-3S (894763M5)	30/372-24 (1860503M93)		
240, 250 Frein positif / Wet brakes 243, 253, 263 265, 275 (UK) 275E, 290, 290E (Std - Anghis / Normal duty - UK)	30/370-4 (884850M3)		30/372-3 (1851392M91)		
255, 260, 265, 275 (France) 285, 290 (Std - France / Normal duty - France)				30/372-4 (1881931M91)	30/376-4 (1860954M1)
275E, 285, 290, 290E (Renforcé / Heavy duty) 298		Derniers Cassette Later Cassette seal 30/371-3 (3699800M2)	30/372-24 (1860503M93)		
350, 352, 355, 360, 362, 362N, 365, 372N, 382N, 390T, 396 375, 375E, 390, 390E (Std / Normal duty)	30/370-4 (884850M3)		30/372-3 (1851392M91)		
375, 375E, 390, 390E (Renforcé / Heavy duty) 398, 399			30/372-24 (1860503M93)		
560, 565, 575 (2 WD) 675 (Std / Normal duty)	30/370-4 (884850M3)		30/372-3 (1851392M91)		30/376-4 (1860954M1)
575 (4 WD), 675 (Renforcé / Heavy duty), 590, 592, 690, 698, 698T, 699, 1004, 1004T, 1085, 1250 595, 595MKII, 1080 Frein positif / Wet brakes			30/372-24 (1860503M93)		
595, 595MKII, 1080 Freins sec / Dry brakes					30/376-3 (894782M2)
1200	30/370-4 (884850M3)		30/372-3 (1851392M91)		

Les références des pièces sont indicatives.
Nos pièces ne sont pas d'origine

Part numbers are quoted for reference purposes only.
Our parts and accessories are not original.



"THE RELIABLE SERVICE"



**PONT ARRIERE
REAR AXLE**

Arbres épicycliques (Freins à disque) / Epicyclic axles (Disc brakes)

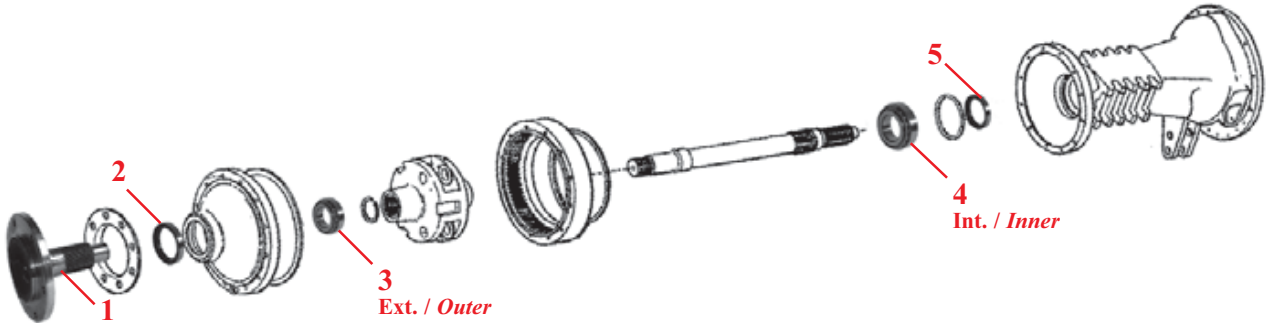

Tracteurs Tractors	1 Arbre Axle shaft	2 Bague Outer seal	3 Roulement ext. Outer Bearing	4 Roulement int. Inner bearing	5 Bague int. Inner seal
Tracteurs français, anglais & américains / French, UK & USA tractors					
4215, 4220, 4315, 4320 4225, 4235, 4240, 4245, 4255, 4260, 4325, 4335, 4345, 4355, 4360 <i>Std / Normal duty</i>	30/370-4 (884850M3)	30/371-3 (3699800M2)	30/372-3 (1851392M91)	30/372-4 (1881931M91)	30/376-4 (1860954M1)
4225, 4235, 4240, 4245, 4255, 4260, 4325, 4335, 4345, 4355, 4360 <i>Renforcé / Heavy duty</i> 4265, 4270, 4365, 4370			30/372-24 (1860503M93)		
Tracteurs industriels / Industrial tractors					
20E, 20F, 30D	30/370-4 (884850M3)	Preins Boitier étal Early Metal cased 30/371-3S (894763M5) Derniers Cassette Later Cassette seal 30/371-3 (3699800M2)	30/372-3 (1851392M91)	30/372-4 (1881931M91)	30/376-3 (894782M2) 30/376-4 (1860954M1)
30E 50E, 50EX <i>Std / Normal duty</i>				83x125x25 30/372-4 (1881931M91) 85x125x25 30/372-38 (1861106M91)	
40, 50 <i>Freins sec / Dry brakes</i>					
40 <i>Frein positif / Wet brakes</i>					
50 <i>Frein positif / Wet brakes</i> 50B, 50BMKII					
50D 50E, 50EX <i>Renforcé / Heavy duty</i> 50H, 50H-S, 50H-T, 50HX, 50HX-S, 50HX-T, 60H, 60H-S, 60HX, 60HX-T		30/372-24 (1860503M93)	30/372-38 (1861106M91)		
Fermeq & Terex - Tracteurs industriels / Industrial tractors					
Modèles 750, 760, 860 <i>models (2WD)</i>		30/371-3 (3699800M2)	30/372-24 (1860503M93)	30/372-38 (1861106M91)	

Les références des pièces sont indicatives.
Nos pièces ne sont pas d'origine

Part numbers are quoted for reference purposes only.
Our parts and accessories are not original.



**PONT ARRIERE
REAR AXLE**

Arbres épicycliques (Freins à piston) / Epicyclic axles (Piston brakes)

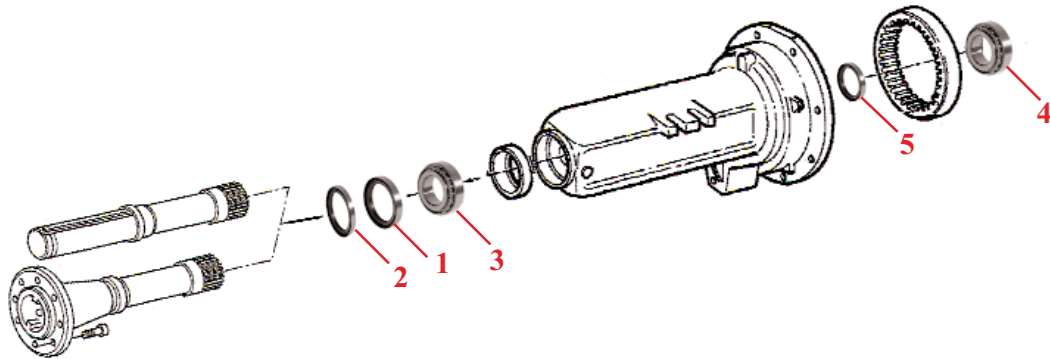

	1	2	3	4	5
Tracteurs Tractors	Bague std Outer seal std	Bague Paddy Outer seal 'Paddy'	Roulement ext. Outer Bearing	Roulement int. Inner bearing	Bague int. Inner seal
Tracteurs français / French tractors					
2620, 2625, 2640, 2645, 2680, 2685, 2720, 2725 (Std / Normal duty)			30/372-39 (1883279M91)	30/6410-34 (3764595M1)	30/376-16 (1610187M1)
2625, 2645, 2685, 2725 (Axe court - Std / Short axle - Normal duty)	30/371-31 (1610188M1)		30/372-40 (3405346M91)	30/372-44 (3405248M91)	30/376-17 (843886M1)
2640, 2645, 2680, 2685, 2720, 2725 (Renforcé / Heavy duty)					
3050, 3060, 3065, 3070, 3075, 3080, 3085, 3090, 3095	30/371-32 (3386895M2)	30/371-35 (3619137M1)	30/372-24 (1860503M93)	30/372-45 (3383324M1)	30/376-18 (3619343M1)
3115, 3120, 3120T, 3125, 3140 3610, 3630, 3635, 3645, 3650 Pignon finalintérieur/ Inner final drive gear	⇒ D080023 Boîtier étal Metal case 30/371-31 (1610188M1) D080024 ⇒ 102x140X8/8.5 30/371-33 (3619135M1)	30/371-36 (3619139M1)	1er / Early 84x137x30 30/372-40 (3405346M91) Dernier / Late 86x137x30 30/372-41 (3383716M1)	30/372-44 (3405248M91)	1er / Early Boîtier étal Metal case 30/376-17 (843886M1) Dernier / Late 83x105X12 30/376-19 (3619344M1)
3610, 3630, 3635, 3645, 3650, 3655 Pignon finalextérieur- 1ers adèles Outer final drive gear - Early 3680			30/372-40 (3405346M91)		30/376-17 (843886M1)
3610, 3630, 3635, 3645, 3650, 3655 Pignon finalextérieur- derniers adèles Outer final drive gear - Late 3630, 3635, 3645, 3650 Arte Ø2 & 5mm avec boîtier scellé 82 & 85mm shaft Ø with sealed housing	30/371-34 (3583530M2)	30/371-37 (3619138M1)	30/372-42 (3383714M1)	30/372-46 (3383712M1)	30/376-20 (3619345M1)
3635, 3645, 3655, 3660, 3670, 3680 Arte Ø5mm avec boîtier scellé 95mm shaft Ø with sealed housing 3670, 3690 Avec réducteur composé / With composite reducer					30/372-43 (3383709M1)
6110, 6120, 6130, 6140, 6150, 6160, 6170, 6235, 6245, 6255, 6260, 6265, 6270	30/371-32 (3386895M2)	30/371-35 (3619137M1)	30/372-24 (1860503M93)	30/372-45 (3383324M1)	30/376-18 (3619343M1)
6180, 6190, 6280, 6290	30/371-33 (3619135M1)	30/371-36 (3619139M1)	30/372-41 (3383716M1)	30/372-44 (3405248M91)	30/376-19 (3619344M1)
8110, 8120 Pignon finalintérieur/ Inner final drive gear					

Les références des pièces sont indicatives.
Nos pièces ne sont pas d'origine

Part numbers are quoted for reference purposes only.
Our parts and accessories are not original.



**PONT ARRIERE
REAR AXLE**

Arbres épicycliques (Freins à piston) / Epicyclic axles (Piston brakes)

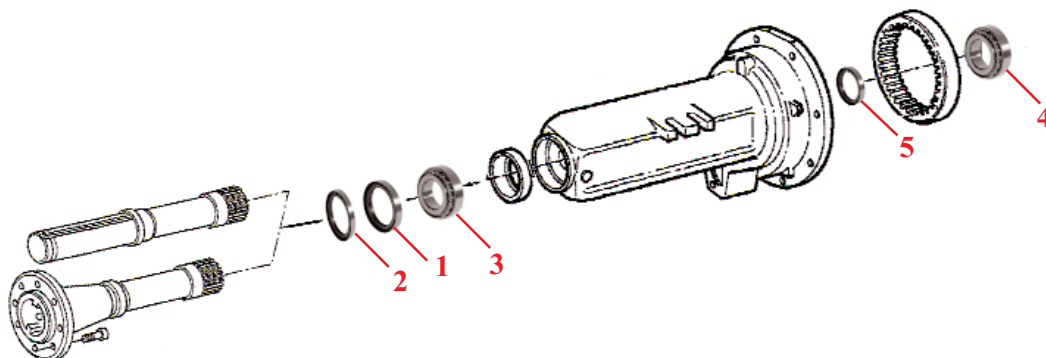

	1	2	3	4	5
Tracteurs Tractors	Bague std Outer seal std	Bague Paddy Outer seal 'Paddy'	Roulement ext. Outer Bearing	Roulement int. Inner bearing	Bague int. Inner seal
Tracteurs français / French tractors					
8110, 8120, 8130, 8140, 8210 Pignon final extérieu Avec Ø2 & 5mm avec bitier scellé Outer final drive gear 82 & 85mm shaft Ø with sealed housing			30/372-42 (3383714M1)	30/372-46 (3383712M1)	30/376-20 (3619345M1)
8110, 8120, 8130, 8140, 8150, 8220, 8240, 8250 Avec Ø95mm avec bitier scellé 95mm shaft Ø with sealed housing	30/371-34 (3583530M2)		30/372-43 (3383709M1)		30/376-21 (3619346M1)
8150, 8160 Avec réducteur composé / With composite reducer					
8210, 8220 Avec Ø95mm 95mm shaft Ø					
8170, 8180, 8260, 8270, 8280 Avec réducteur double / With dual reducer			30/372-47 (3010685X91)	30/372-48 (3010672X91)	
	30/371-39 (3716210M1)				
8240, 8250, 8260 Avec réducteur composé / With composite reducer			30/372-49 (3010912X91)	30/372-43 (3383709M1)	

Les références des pièces sont indicatives.
Nos pièces ne sont pas d'origine

Part numbers are quoted for reference purposes only.
Our parts and accessories are not original.



**PONT ARRIERE
REAR AXLE**

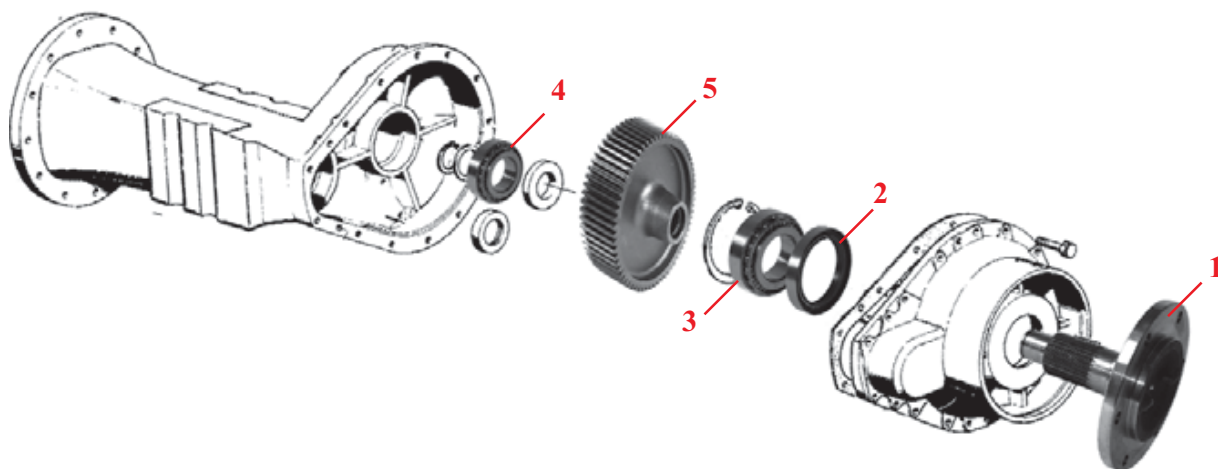

Tracteurs Tractors	1 Arbre Axle shaft	2 Bague Oil seal	3 Roulement ext. Outer bearing	4 Roulement int. Inner bearing	5 Pignon Gear
IT Tracteurs italiens à roues / Italian wheeled tractors					
154, 234S, 254, 254S, 273	30/370-10 (1824718M2)	30/371-28 (394608X1)	30/372-26 (1440550X1)	30/372-54 (1440546X1)	55 dents <i>55 teeth</i>
174, 233, 253, 263T, 264T/TS, 274, 274S/SK				30/372-55 (3003369X1)	30/378-2 (1824719M3)
184, 194, 283, 284, 284S, 293, 294, 294S	30/370-11 (1824722M3)	30/371-29 (975127M1)	30/372-25 (1440547X1)	30/372-27 (1440561X1)	67 dents <i>67 teeth</i> 30/378-3 (1824723M3)
283HD, 284HD, 293HD, 294HD, 294SHD		Bague <i>Oil seal</i> 30/371-29 (975127M1) O-ring 30/371-40 (1440895X1)	30/372-50 (1444542X1)	30/354-16 (1440640X1)	
333, 353, 353LX/S, 363, 363LX/S, 373, 373LX/S, 377 2225, 2230, 2235 (<i>Non cbnhrd / Non Sherpa</i>)		Std 30/371-41 (3019953X1)	30/372-51 (3532250M91)		
383, 383LX/S, 387, 393, 393LX/S/TLX, 397, 397T, 1007 <i>Standard &Stdégagement / Std & high clearance</i>		Std 30/371-42 (3019954X1)	30/372-52 (1441406X1)	30/352-11 (330376X1)	
2205, 2210, 2220 2225, 2230, 2235 (<i>Cbnhrd / Sherpa</i>)			30/372-53 (3537279M91)		

Les références des pièces sont indicatives.
Nos pièces ne sont pas d'origine

Part numbers are quoted for reference purposes only.
Our parts and accessories are not original.



**PONT ARRIERE
REAR AXLE**

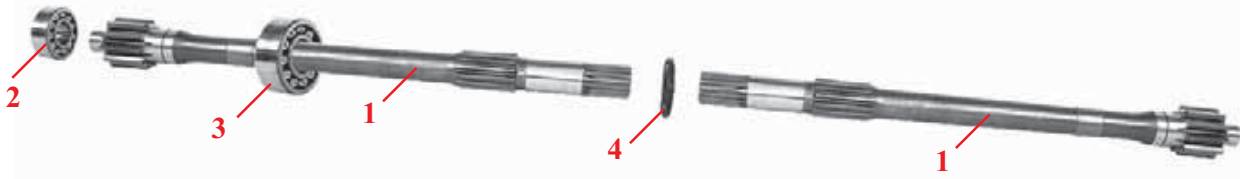

	1	2	3	4
Tracteurs Tractors	Arbre Half shaft	Roulement Bearing	Roulement Bearing	Bague Oil seal
IT Tracteurs italiens à roues / Italian wheeled tractors				
154, 234S 254, 254S <i>Freins secs / Dry brakes</i>	30/387-10 (1424916M3)	30/372-28 (1440593X1)	30/372-54 (1440546X1)	30/376-14 (395559X1)
174 274, 274S <i>Freins secs / Dry brakes</i>			30/372-55 (3003369X1)	
184				
194	30/387-9 (1424282M2)	30/372-29 (1442067X1)	30/372-54 (1440546X1)	30/305-21 (3306228M1)
233, 253, 263T, 264T/TS, 273, 274SK 254, 254S, 274 <i>Freins sèches / Wet brakes</i>		30/372-28 (1440593X1)	30/372-56 (3300945M1)	30/376-22 (1442216X1)
284S 294S <i>Freins secs / Dry brakes</i>		30/372-29 (1442067X1)	30/372-57 (392040X1)	30/305-21 (3306228M1)
283, 284, 293, 294				30/376-23 (392825X1)
294S <i>Freins sèches / Wet brakes</i>				
283HD, 284HD, 293HD, 294HD, 294SHD		30/353-11 (390876X1)	30/352-24 (1440644X1)	30/376-22 (1442216X1)
333, 353, 353LX/S, 363, 363LX/S, 373, 373LX/S, 377 2225, 2230, 2235 <i>(Non standard / Non Sherpa)</i>		30/354-18 (1820418M1)		
383, 383LX/S, 387, 393, 393LX/S/TLX, 397, 397T <i>Standard haut-dégagement / Std & high clearance</i>		30/353-11 (390876X1)	30/353-14 (3019932X1)	30/376-23 (392825X1)
1007 <i>Haut-dégagement / High clearance</i>			30/372-58 (3008775X91)	
393TLX, 1007				
2205, 2210, 2220 2225, 2230, 2235 <i>(Standard / Sherpa)</i>			30/372-59 (3554660M91)	30/376-24 (3015184X1)

Les références des pièces sont indicatives.
Nos pièces ne sont pas d'origine

Part numbers are quoted for reference purposes only.
Our parts and accessories are not original.



**PONT ARRIERE (4RM)
REAR AXLE (4WD)**

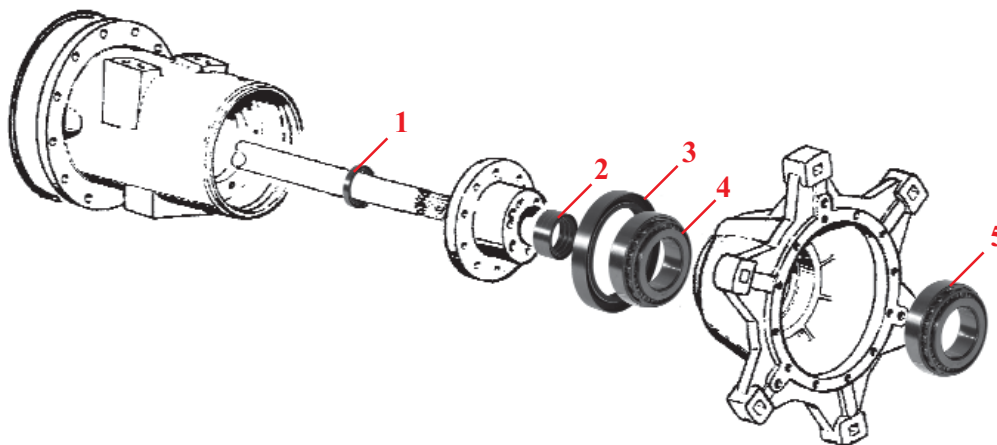

	1	2	3	4	5
Tracteurs Tractors	Bague Oil seal	Bague Bush	Bague Oil seal	Roulement int. Inner bearing	Roulement ext. Outer bearing
IT Tracteurs italiens à roues / Italian wheeled tractors					
134V, 154V, 164TV	30/6407-43 (1441815X1)	30/6462-1 (3426938M1)	30/6408-2 (3429791M1)	30/6410-3 (3426850M2)	
174V			30/6408-3 (3429815M3)	30/6410-4 (3426851M2)	
154S, 174S Freins secs / Dry brakes	30/6407-4 (392108X1)	30/6462-15 (1823602M1)	30/6408-5 (395527X1)	30/6410-6 (391337X1)	30/6410-5 (391336X1)
154S, 174S Freins <i>sous</i> / Wet brakes 154F, 164TF/TS, 174F	30/6407-44 (3305762M1)				
184S Freins secs / Dry brakes	30/6407-18 (395522X1)	30/6462-16 (1617854M1)	30/6408-4 (395521X1)	30/6410-1 (1442254X1)	30/6410-2 (1442255X1)
184S Freins <i>sous</i> / Wet brakes 184F, 194F/S	30/6407-45 (3306490M1)				
174F, 194F Haut <i>dégagement</i> / High clearance					
354, 3210 Tous <i>modèles safi</i> / All models except 354V(07/94 ⇒) Joint std / Std seal	30/6407-43 (1441815X1)	30/6462-46 (3533036M1)	30/6408-2 (3429791M1)	30/6410-3 (3426850M2)	
364, 374, 384, 394, 3220, 3225, 3235 <i>Modèles / Models S & SP (A)</i>			30/6408-3 (3429815M3)	30/6410-4 (3426851M2)	
354VQ (07/94 ⇒) 364, 374, 384, 394, 3220, 3225, 3235 Tous <i>modèles safi (A)</i> / All models except (A) Joint std / Std seal					

(A) Modèles *S* avec pneu ballon et modèles *SP* avec pneu 8.4/16.1 et 21.5/16.1
'S' models with balloon tyres. 'SP' models with 18.4/16.1 and 21.5/16.1 tyres.

Les références des pièces sont indicatives.
Nos pièces ne sont pas d'origine

Part numbers are quoted for reference purposes only.
Our parts and accessories are not original.



**PONT ARRIERE
REAR AXLE**

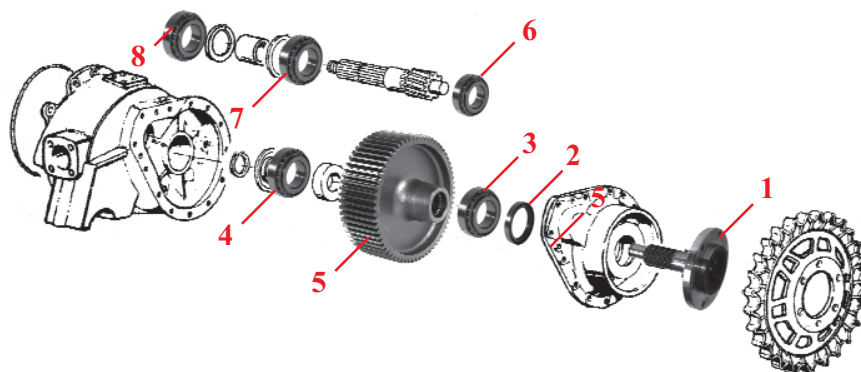

	1	2	3	4	5
Tracteurs Tractors	Arbre Axle shaft	Bague Oil seal	Roulement ext. Outer bearing	Roulement int. Inner bearing	Pignon Gear
IT Tracteurs italiens à chenilles / Italian crawler tractors					
134C, 234C/CF, 244CF	30/370-10 (1824718M2)	30/371-28 (394608X1)	30/372-26 (1440550X1)	30/372-54 (1440546X1)	55 dents / teeth 30/378-2 (1824719M3)
154C, 174C	30/370-11 (1824722M3)	30/371-29 (975127M1)	30/372-25 (1440547X1)	30/372-27 (1440561X1)	67 dents / teeth 30/378-3 (1824723M3)
254C/CF, 264TCF, 274C/CF, 364CF				30/372-61 (392151X1)	
356CF, 366CF, 367CF		30/371-41 (3019953X1)	30/372-51 (3532250M91)	30/354-16 (1440640X1)	
376C/CF/XCF, 394C, 396C/CF/CT		30/371-42 (3019954X1)	30/372-52 (1441406X1)	30/352-11 (330376X1)	

	6	7	8		
Tracteurs Tractors	Roulement ext. Outer bearing	Roulement int. Inner bearing	Bague Oil seal		
IT Tracteurs italiens à chenilles / Italian crawler tractors					
134C, 234C/CF, 244CF <i>Chenilles std et étroites / Std and narrow tracks</i>	30/372-70 (1442530X1)	30/372-66 (1440511X1)	30/376-25 (3305774M1)		
134C, 234C/CF, 244CF <i>Chenilles larges / Wide tracks</i>	30/372-28 (1440593X1)				
154C, 174C <i>Chenilles std et étroites / Std and narrow tracks</i>	30/372-63 (1440591X1)	30/372-67 (1441048X1)			
154C, 174C <i>Chenilles larges / Wide tracks</i>	30/372-29 (1442067X1)	30/372-66 (1440511X1)			
254C/CF, 264TCF, 274C/CF, 364CF <i>Chenilles std et étroites / Std and narrow tracks</i>	30/372-65 (391338X1)	30/354-6 (1440635X1)			
254C/CF, 264TCF, 274C/CF, 364CF <i>Chenilles larges / Wide tracks</i>	30/353-11 (390876X1)				
356CF, 366CF, 367CF	30/354-18 (1820418M1)				
376C/CF/XCF, 396C/CF/CT	30/353-11 (390876X1)	30/353-14 (3019932X1)			
394C		30/372-69 (390859X1)	30/376-26 (392775X1)		

Les références des pièces sont indicatives.
Nos pièces ne sont pas d'origine

Part numbers are quoted for reference purposes only.
Our parts and accessories are not original.



"THE RELIABLE SERVICE"



PONT ARRIERE - PLANETAIRE
REAR AXLE - PLANETARY

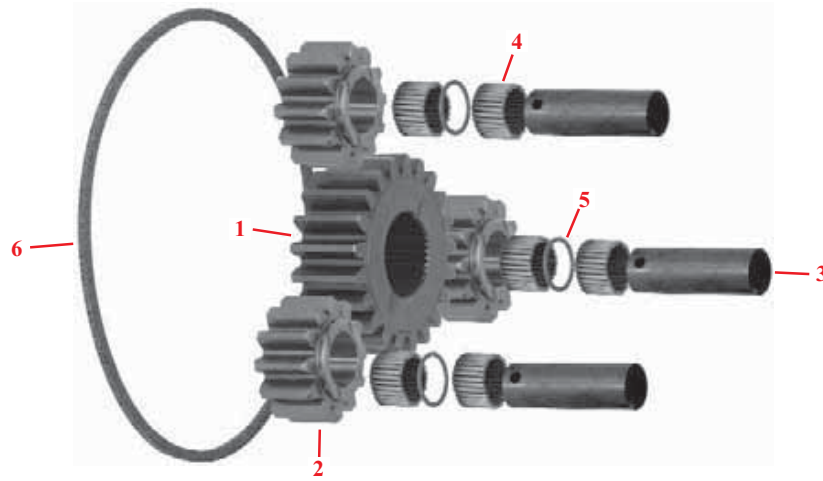

Fig.	1	2	3	4	5	6
Tracteurs Tractors	Pignon plan. Planet. gear	Pignon sat. Pinion	Axe Shaft	Galet Needle roller	Rondelle Washer	Joint Gasket
65, 145 (Pretrars / Early), 765, 865 133, 135, 140 (Etroit - A&nt - Narrow - Germ.) 152, 155, 158 (Etroit / Narrow)			30/381-1 (1868115M1)			
135 (USA - Fritier / Orchard) 145 (Derniers / Late), 152, 155, 158, 165, 168, 175, 178, 185, 188			30/381-2 (A) (894799M1)			30/385-1 (184182M3)
135 (USA - Fritier / Orchard) 135, 145, 148 (MKIII - France) 152, 155, 158, 165, 168, 185, 188	30/379-1 (897005M1)	30/380-1 (894769M1)		30/383-1 (184742M1)	30/384-1 (184196M1)	
240 (Freins s&ouil - Wet brakes) 250, 255, 260, 265, 275, 285, 290 (Std / Normal duty)						
243, 253, 275E, 290E, 375E, 390E (Std / Normal duty)						
350, 355, 360, 365, 375, 390, 390T			30/381-3 (B) (1864869M1)			Pretrars Early 30/385-1 (184182M3)
352, 362, 362N, 372N, 382N, 396						
565, 575, 675, 690 (Std / Normal duty)	30/379-1 (897005M1)	30/380-1 (894769M1)		30/383-1 (184742M1)	30/384-1 (184196M1)	30/385-1 (184182M3)
1200						
Séries 4200 & 300 Series (Std / Normal duty)						

(A) Troude fixation fraisé / Countersunk locating hole

(B) Troude fixation droit / Parallel locating hole

Les références des piéces sont indicatives.
Nos piéces ne sont pas d'origine

Part numbers are quoted for reference purposes only.
Our parts and accessories are not original.



**FREINS A TAMBOUR
DRUM BRAKES**

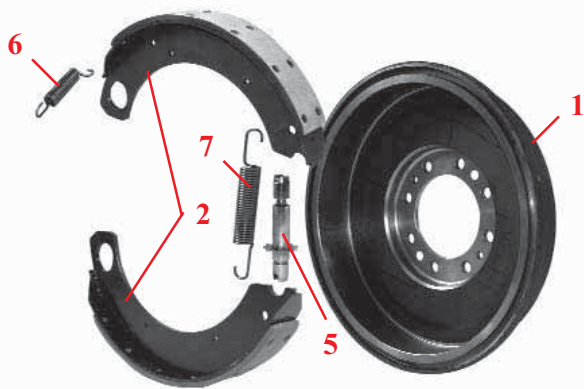

	1	2	3	4	5	6	7
Tracteurs Tractors	Tambour Brake drum	Paire de mâchoires Brake shoe pair	Jeu de garnitures Lining kit	Jeu de fixation Brake pin kit	Réglage Adjuster	Ressort Spring	Ressort Spring
TEA20, TED20, TEF20, TEH20, 35, 133, 135, 140, 148, 230, 235, 240, 245, 250, 340, 550, 835 Tabn sipit Single brake drum	30/400-1 (827707M5)						30/408-1 (1850217M1)
65, 152, 155, 158, 165, 168, 175, 178, 185, 188, 255, 260, 265, 275, 285, 290, 560, 575, 590, 595, 595MKII, 765, 1080 Tabn sipit Freins secondaire - Allemagne Single brake drum Secondary brakes - Germany		30/403-1 (3620602M91)	30/404-1 (3620600M91)	30/405-1 (A) (1810029M91)	30/406-1 (1850213M91)	30/407-1 (1890319M1)	
133, 135, 140, 235, 245, 250 Tabn dob - Allemagne Dual brake drum - Germany							Large 30/408-1 (1850217M1)

(A) 30/405-1 comprend / content : 4x 1850207M1 + 8x 1850218M1 + 4x 1850219M1

Les références des pièces sont indicatives.
Nos pièces ne sont pas d'origine

Part numbers are quoted for reference purposes only.
Our parts and accessories are not original.



**FREINS A DISQUE (SEC)
DRY DISC BRAKES**

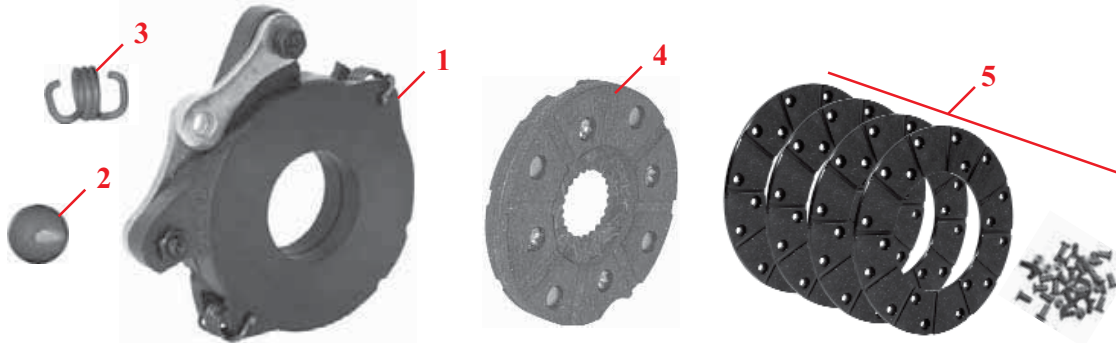

	1	2	3	4	5
Tracteurs Tractors	Mécanisme Actuator assy.	Bille Ball bearing	Ressort Spring	Disque Friction disc	Jeu de garniture Lining kit
Tracteurs français, anglais & américains / French, UK & USA tractors					
65, 145, 152, 155, 165 (AD4.203), 175, 178, 765, 865 133, 135, 140 <i>Abagne / Germany</i>	30/417-1 (764805M92)	30/418-1 (16779X) 7/8"	30/419-1 (1005510M1)	30/420-1 (3910276M91)	30/421-1 (3910292M91)
135, 1080 (USA) 165MKIII, 178 (France) <i>Avec carter mab / With malleable housing</i> Diamètre 178m7" <i>diameter</i>					
135, 1080 (USA) 165MKIII, 178 (France) <i>Avec carter acier / With cast iron housing</i>	30/417-31 (535873M91)	30/418-6 (1805984M1) 1"	30/419-2 (1853148M1)	30/420-26 (3609079M1)	30/421-9 (3910278M91)
165 (A4.212), 168, 185, 188, 595, 595MKII, 1080, 1200 Diamètre 222m8 <i>3/4" diameter</i>					
IT Tracteurs italiens / Italian tractors					
154, 174, 184, 194, 254, 254S, 274, 274S, 284S, 294S <i>Premières modèles / Early models</i> Diamètre 165m6 <i>1/2" diameter</i>	30/417-29 (1822606M92)	30/418-1 (16779X) 7/8"	30/419-2 (1853148M1)	30/420-27 (1823112M92)	30/421-8 (3910280M91)
154, 154S, 174, 174S, 184S, 234S, 254, 254S, 274, 274S, 294S <i>Dernières modèles / Later models</i> Diamètre 178m7" <i>diameter</i>	30/417-35 (1895334M91)		30/419-1 (1005510M1)	30/420-28 (1895852M91)	30/421-1 (3910292M91)
1104 Diamètre 178m7" <i>diameter</i>	30/417-1 (764805M92)		30/420-1 (3910276M91)		

Tracteurs Tractors	Réf. Ref.	Fig.	Description
Jeu de plaquettes de frein / Set of brake pads			
122, 130	30/412-10 (3910279M91)		Jeu de 4 plaquettes de frein Set of 4 brake pads

Les références des pièces sont indicatives.
Nos pièces ne sont pas d'origine

Part numbers are quoted for reference purposes only.
Our parts and accessories are not original.



"THE RELIABLE SERVICE"



FREINS A DISQUE (BAIN D'HUILE)
OIL IMMERSED DISC BRAKES

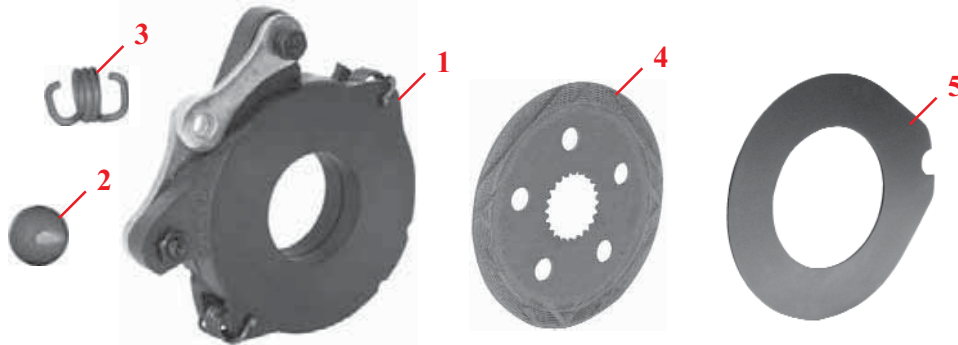

Tracteurs Tractors	1 Mécanisme Actuator assy.	2 Bille Ball bearing	3 Ressort Spring	4 Disque Friction disc	5 Disque interm. Intermediate disc
Tracteurs français, anglais & américains / French, UK & USA tractors					
Séries 100,"200,"500,"600" series 240 (⇒ A20286) Série 300" series (Freins concentriques / Concentric brakes ⇒ V39465) 1004, 1004T, 1080, 1085, 1200, 1250	30/417-2 (1860963M92)	30/418-1 (16779X)	30/419-2 (1853148M1)	30/422-1 (1860964M2)	30/423-1 (1860965M2)
240 (A20287 ⇒)	30/417-36 (3610998M91)		30/422-44 (3700134M1)	30/423-20 (3613538M1)	
340 (⇒ A43068)	<i>Gauche / LH</i> 30/417-37 (3613536M91)		30/422-45 (3613539M1)		
340 (A43069 ⇒) 342	<i>Droit / RH</i> 30/417-38 (3613537M91)		30/419-7 (1890318M1)	30/422-44 (3700134M1)	
Série 300" series (Freins tangentiels / Tangential brakes V39466 ⇒) Séries 4200,"4300" series	<i>Gauche / LH</i> 30/417-39 (3596776M91)			30/422-1 (1860964M2)	30/423-1 (1860965M2)
	<i>Droit / RH</i> 30/417-40 (3596778M91)				
IT Tracteurs italiens / Italian tractors					
Séries 100,"200,"300,"3200" series	30/417-30 (3308792M91)	<i>Girling</i> 30/418-1 (16779X) <i>Sirac</i> 30/418-7 (3310764M1)	<i>Girling</i> 30/419-1 (1005510M1) <i>Sirac</i> 30/419-8 (3310765M1)	30/422-29 (3550896M1)	30/423-13 (3308296M2)
1014, 1024, 1114, 1134 (⇒ R37147)	30/417-2 (1860963M92)	30/418-1 (16779X)	30/419-2 (1853148M1)	30/422-1 (1860964M2)	30/423-1 (1860965M2)
1014, 1024, 1114, 1134 (R37148 ⇒)	30/417-41 (3538836M91)			30/422-46 (3538837M1)	30/423-21 (3538838M1)
2205, 2210, 2220, 2230	30/417-42 (3649157M91)	30/418-7 (3310764M1)	30/419-8 (3310765M1)	30/422-47 (3537089M1)	30/423-22 (3557269M1)

Les références des pièces sont indicatives.
Nos pièces ne sont pas d'origine

Part numbers are quoted for reference purposes only.
Our parts and accessories are not original.



DISQUES, PISTONS ET JOINTS DE FREIN
BRAKE DISCS PISTONS AND SEALS



Tracteurs Tractors	1 Disque Brake disc	2 O-ring 'O' Ring	3 O-ring 'O' Ring	
2620, 2625, 2640, 2645, 2680, 2685, 2720, 2725	30/422-8 (3386897M92)	30/416-16 (A) (1610179M5)	30/416-18 (A) (1610178M5)	
3050, 3060, 3065 (⇒ B126033)	30/422-53 (3582085M92)	30/416-17 (B) (3617902M3)	30/416-19 (B) (3617901M2)	
3050, 3060, 3065 (B126034 ⇒)	30/422-54 (3617651M91)			
3070, 3080, 3085, 3090, 3095 (⇒ B082008)	30/422-7 (3386896M92)			
3070, 3080, 3085, 3090, 3095 (B082009 ⇒) 3075	30/422-20 (3617652M91)			
3115, 3120, 3120T, 3125, 3140 (⇒ B126020)	30/422-8 (3386897M92)			
3115, 3120, 3120T, 3125, 3140 (B126021 ⇒)	30/422-21 (3617653M91)			
3610, 3630, 3650 3645 (⇒ S283003) <i>Coronne de réduction finale intérieure / Inner final drive gear</i>	30/422-8 (3386897M92)			30/416-16 (A) (1610179M5)
3610, 3630, 3645, 3650, 3655 (⇒ S283003) <i>Coronne de réduction finale extérieure / Outer final drive gear</i>				
3630, 3645, 3650, 3655, 3660, 3680 (⇒ S283003) <i>Avec carter scellé / With sealed housing</i>				
3635 (⇒ B125034) 3645 (S283004 ⇒ B125034) <i>Coronne de réduction finale intérieure / Inner final drive gear</i>				
3610, 3630, 3650 (S283004 ⇒) 3635 (⇒ B126025) 3645, 3655 (S283004 ⇒ B126025) <i>Coronne de réduction finale extérieure / Outer final drive gear</i>				
3630, 3650, 3660, 3680 (S283004 ⇒) 3635 (⇒ B116025) 3645, 3655 (S283004 ⇒ B112025) 3670 (⇒ B112025) <i>Avec carter scellé / With sealed housing</i>				
3635, 3645 (B125035 ⇒) <i>Coronne de réduction finale intérieure / Inner final drive gear</i>		30/422-21 (3617653M91)	30/416-17 (B) (3617902M3)	30/416-19 (B) (3617901M2)
3635, 3645, 3655 (B126026 ⇒) <i>Coronne de réduction finale extérieure / Outer final drive gear</i>				
3635 (B116026 ⇒) 3645, 3655, 3670 (B112026 ⇒) <i>Avec carter scellé / With sealed housing</i>				

- (A) 30/416-16 et 30/416-18 sont disponibles en jeu 30/416-25 (3900234M92) comprenant 2 O-rings de chaque type
30/416-16 and 30/416-18 are available as a set 30/416-25 (3900234M92) containing two of each 'O' ring.
- (B) Les premiers joints 3382190M1 et 3382189M1 sont remplacés par le jeu 30/416-26 comprenant 2x 30/416-17 (3617902M3) + 2x 30/416-19 (3617901M2)
Early 'O' rings 3382190M1 and 3382189M1 are replaced by a set 30/416-26 containing 2x 30/416-17 (3617902M3) + 2x 30/416-19 (3617901M2)

Les références des pièces sont indicatives.
Nos pièces ne sont pas d'origine

Part numbers are quoted for reference purposes only.
Our parts and accessories are not original.



PISTONS DE FREIN
BRAKE DISCS PISTONS AND SEALS



	1	2	3
Tracteurs Tractors	Disque Brake disc	O-ring 'O' Ring	O-ring 'O' Ring
3670, 3690 (⇒ A294002) <i>Avec réducteur composé / With composite reducer</i>	30/420-31 (3616538M92)	30/416-17 (B) (3617902M3)	30/416-19 (B) (3617901M2)
3670, 3690 (A294003 ⇒) <i>Avec réducteur composé / With composite reducer</i>	30/422-55 (3617649M91)		
6110, 6120, 6130, 6140, 6235	30/422-54 (3617651M91)		
6150, 6160, 6170, 6245, 6255, 6260, 6265, 6270	30/422-20 (3617652M91)		
6180, 6190 6280, 6290 (⇒ L023001)	30/422-21 (3617653M91)		
6280, 6290 (L023002 ⇒)	30/422-56 (3795499M1)		
8110, 8120, 8130 <i>Coronne de réduction finale int.&ext.</i> <i>Inner & outer final drive gear</i>	30/422-21 (3617653M91)		
8110, 8120, 8130, 8140, 8150 <i>Avec carter scellé / With sealed housing</i>			
8150, 8160 <i>Avec réducteur composé / With composite reducer</i>	30/422-55 (3617649M91)		
8160, 8170, 8180 <i>Avec réducteur dal / With dual reducer</i>	30/422-57 (3716223M1)		
8210, 8220 <i>Coronne de réduction finale extérieure / Outer final drive gear</i>	30/422-55 (3617649M91)		
8220, 8240, 8250 <i>Avec carter scellé / With sealed housing</i>		30/416-20 (3716252M2)	
8240, 8250, 8260 <i>Avec réducteur composé / With composite reducer</i>			30/416-23 (3716335M1)
8260, 8270, 8280 <i>Avec réducteur dal / With dual reducer</i>	30/422-57 (3716223M1)	30/416-22 (3716253M1)	
IT Tracteurs italiens / Italian tractors			
3315, 3325, 3330, 3340, 3350, 3355	30/422-58 (0.008.5173.2)	30/416-21 (2.1539.178.0)	30/416-24 (2.1539.177.0)

(B) Les pièces joints 3382190M1 et 3382189M1 sont remplacés par le jeu 30/416-26 contenant 2x 30/416-17 (3617902M3) + 2x 30/416-19 (3617901M2)
Early 'O' rings 3382190M1 and 3382189M1 are replaced by a set 30/416-26 containing 2x 30/416-17 (3617902M3) + 2x 30/416-19 (3617901M2)

Les références des pièces sont indicatives.
Nos pièces ne sont pas d'origine

Part numbers are quoted for reference purposes only.
Our parts and accessories are not original.



**FREINS À MAIN
HANDBRAKES**

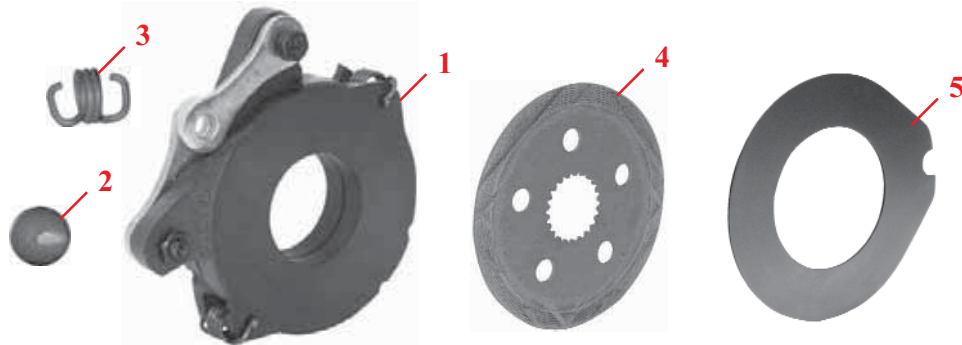









Tracteurs Tractors	1 Mécanisme Actuator assy.	2 Bille Ball bearing	3 Ressort Spring	4 Disque Friction disc	5 Disque interm. Intermediate disc
Séries 2600,"2700,"3600" series 8110, 8120, 8130, 8140, 8150, 8160	30/417-43 (3617341M2)	⇒ S206031 30/418-1 (16779X) S206032 ⇒ 30/418-7 (3310764M1)		30/422-48 (3715250M2)	30/423-23 (3380442M1)
Séries 3000,"3100,"6100" series (⇒ E327006)	30/417-44 (3382325M1)	30/418-8 (15024X)	30/419-9 (3310812M1)	30/422-49 (3385987M1)	
Séries 3000,"3100,"6100" series (E327007 ⇒) 6235, 6245, 6255, 6260, 6265, 6270 (⇒ J325024) 6280, 6290 (⇒ J320011) 6290 (Copte coniq renforcé / HD bevel gear ⇒ J314029)					
6235, 6245, 6255, 6260, 6265, 6270 (J325025 ⇒) 6280, 6290 (J320012 ⇒) 6290 (Copte coniq renforcé / HD bevel gear J314030 ⇒)	30/417-45 (3716920M91)	30/418-7 (3310764M1)	30/419-8 (3310765M1)	30/422-50 (3790493M1)	⇒ L037020 30/423-24 (3716932M1)
8170, 8180 Séries 8200" series (⇒ K304025)				3.6 m 30/422-51 (3716933M1)	6 m 30/423-24 (3716932M1)
Séries 8200" series (K304026 ⇒)				4.3 m 30/422-52 (3795093M1)	5 m 30/423-25 (3795094M1)

Les références des pièces sont indicatives.
Nos pièces ne sont pas d'origine

Part numbers are quoted for reference purposes only.
Our parts and accessories are not original.

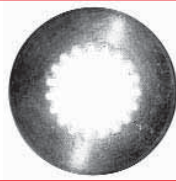

**FREINS À MAIN
HANDBRAKES**

Tracteurs Tractors	Réf. Ref.	Fig.	Description
Mecanismes de frein à main / Handbrake assemblies			
133, 135, 135 V/S, 145 V/S, 148, 152, 230, 235, 240, 245, 250 Freins simples / Single brakes	30/432-1 (898652M94)		Mécanisme de frein à main Handbrake assembly
	30/433-2 (898654M92)		Tringlet Plunger
145, 158, 165, 168, 175, 178, 185, 188 240 (522354 ⇒ A20286 Sans came / Less cab) 250 (Sans came / Less cab) Freins simples / Single brakes	30/432-2 (898931M95, 1871610M91)		Mécanisme de frein à main Handbrake assembly
	30/433-2 (A) (898654M92)		Tringlet Plunger
155, 165, 175, 178, 235, 245, 250, 255, 260, 275, 285 Freins doubles - Allemagne Dual brakes - Germany	30/433-2 (898654M92)		Tringlet Plunger
Disques de frein à main (30km/h avec frein sur transmission) / Handbrake discs (30 Km/h only with brake on transmission)			
154, 154F/S, 174, 174F/S, 184F/S, 194F/S, 253, 254, 254S, 273, 274, 274S/K, 283, 284S, 293, 294S	30/7700-3 (3302355M1) Ø42m		Disque de frein à main Brake disc
	30/7703-5K (2x 3302354M1 + 2x 3302353M1)		Jeux de plaquettes Set of brake pads
1014, 1024, 1114, 1134	30/7700-4 (3302840M1) Ø52m		Disque de frein à main Brake disc
	30/7703-6K (2x 3302354M1 + 3x 3302353M1)		Jeux de plaquettes Set of brake pads

(A) Tringlet pour les premiers mécanismes 898931M95 /

Plunger for the early assemblies 898931M95

Les références des pièces sont indicatives.
Nos pièces ne sont pas d'origine

Part numbers are quoted for reference purposes only.
Our parts and accessories are not original.



**TRINGLERIE DE FREIN
BRAKE LINKAGE**

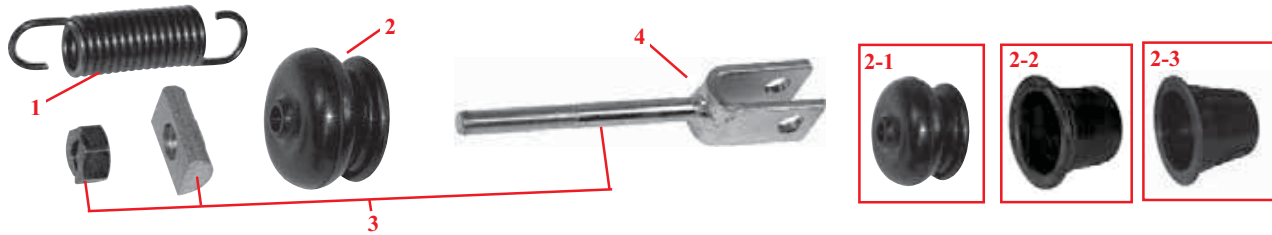

Fig.	1	2	3	4
Tracteurs Tractors	Ressort Spring	Coiffe Cover seal	Kit tringle frein Brake rod kit	Tringle de frein Brake rod
Tracteurs français, anglais, américains - Freins sec / French, UK, USA tractors - Dry brakes				
65, 145, 152, 155, 158, 165, 175, 178, 765, 865	30/233-8 (1868691M1)	30/424-2 (2-1) (183462M1)	30/425-1 (B1060)	30/426-1 (184334M1)
133, 135, 140 (Étroit - Abn1 Narrow - Germ.)				
595, 595MKII, 1080, 1085				
Tracteurs français, anglais, américains - Freins à bain d'huile / French, UK, USA tractors - Wet brakes				
133, 135, 145, 148, 152, 158, 165, 168, 185, 188	30/233-8 (1868691M1)	30/424-1 (2-2) (1860959M1)	30/425-2 (B1061)	30/426-2 (1861676M91)
240, 243, 250, 253, 275E, 285, 290E, 375E, 390E 255, 260, 265, 275, 290 (⇒ A264034)				
255, 260, 265, 275, 290 (A264035 ⇒) 298		30/424-5 (2-3) (1667175M1)		30/426-7 (1698715M91)
560, 565, 575 (⇒ A264034) 590	30/233-8 (1868691M1)	30/424-1 (2-2) (1860959M1)	30/425-2 (B1061)	30/426-2 (1861676M91)
560 (A264035 ⇒)		30/424-5 (2-3) (1667175M1)		30/426-7 (1698715M91)
575, 590 (A264035 ⇒)	30/233-8 (1868691M1)	30/424-1 (2-2) (1860959M1)		
592, 595, 595MKII				
675, 690, 698, 698T, 1004, 1004T		30/424-5 (2-3) (1667175M1)		30/426-7 (1698715M91)
1080, 1085		30/424-1 (2-2) (1860959M1)	30/425-2 (B1061)	30/426-2 (1861676M91)
1200, 1250	30/233-8 (1868691M1)			
Tracteurs italiens - Freins sec / Italian tractors - Dry brakes				
154, 154S, 174, 174S, 184, 184S, 194, 234S, 254, 254S, 274, 274S, 284S, 294S, 1104	30/233-9 (974717M1)	30/424-2 (2-1) (183462M1)		
Tracteurs italiens - Freins à bain d'huile / Italian tractors - Wet brakes				
134V, 154 F/S/V, 164T F/S/V, 174 F/S/V, 184 F/S, 194 F/S, 233, 253, 254, 254S, 263T, 264T, 264TS, 273, 274, 274 S/SK, 283, 284, 294, 294S, 333, 334V, 353, 353 LX/S, 363, 363 LX/S, 373, 373 LX/S, 377, 383, 383 LX/S, 387, 393, 393 LX/S/TLX, 397, 397T, 1007, 1014, 1024, 1114, 1134, 2205, 2210, 2220, 2225, 2230, 2235		30/424-1 (2-2) (1860959M1)		
354, 364, 374, 384, 394, 3210, 3220, 3225, 3235 Tous modèles / All models				

Les références des pièces sont indicatives.
Nos pièces ne sont pas d'origine

Part numbers are quoted for reference purposes only.
Our parts and accessories are not original.



"THE RELIABLE SERVICE"



**PEDALES DE FREIN
BRAKE PEDALS**

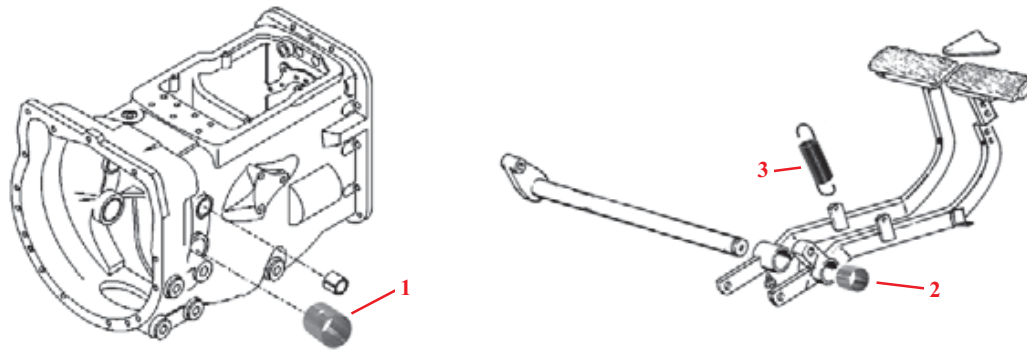







Fig.	1	2	3
Tracteurs Tractors	Bague d'axe de frein <i>Brake shaft bush</i>	Bague de pédale de frein <i>Brake pedal bush</i>	Ressort pédale de frein <i>Brake pedal spring</i>
Tracteurs français, anglais, américains / French, UK, USA tractors			
35, 65, 133, 135, 140, 145, 148, 152, 155, 158, 165, 168, 175, 178, 185, 188, 230, 235, 240, 243, 245, 250, 253, 255, 260, 263, 265, 275, 275E, 285, 290, 290E, 298, 375E, 390E, 765, 835, 865	30/430-1 (180801M1)	30/431-1 (195910M1)	
340, 350, 360, 362, 365, 375, 390 (Boîtes 8 vitesses synchronisées inverser-carter ⇒ A37059 <i>8 speed synchromesh shuttle transmission ⇒ A37059</i>)			
1080, 1085, 1200, 1250			
Tracteurs italiens / Italian tractors			
134V, 154F/S/V, 164T F/S/V, 174 F/S/V, 184 F/S, 194 F/S, 254S, 264TS, 274 S/SK, 284S, 294S, 334V, 377, 387, 397, 397T, 1007, 2205, 2210, 2220, 2225, 2230, 2235	30/430-6 (1423482M1)	30/430-6 (1423482M1)	
354, 364, 374, 384, 394, 3210, 3220, 3225, 3235 Tous modèles / All models			
154, 174, 184, 194, 233, 234S, 253, 254, 263T, 264T, 273, 274, 283, 284, 293, 294, 333, 353, 353 LX/S, 363, 363 LX/S, 373, 373 LX/S, 376 C/CF/XCF, 383, 383 LX/S, 393, 393 LX/S/TLX, 396 C/CF/CT			30/233-10 (981843M3)
234CF, 244CF, 254CF, 264TCF, 274 C/CF, 294C, 356CF, 364CF, 366CF, 367CF, 394C, 1014, 1024, 1114, 1134			

Les références des pièces sont indicatives.
Nos pièces ne sont pas d'origine

Part numbers are quoted for reference purposes only.
Our parts and accessories are not original.



**CABLES DE FREINS
BRAKE CABLES**



Tracteurs Tractors	Réf. Ref.	OEM	Longueur A Length A
			
230, 340 (Freins à tambour / Drum brakes) 240, 243, 253, 263 (2WD) 240 (2WD avec freins à bande d'acier ⇒ D41226 / 2WD with wet brakes ⇒ D41226)	30/409-27	RH 1689024M93	1232 m
	30/409-28	LH 1689025M94	1572 m
240 (2WD avec freins à bande d'acier D41227 ⇒ / 2WD with wet brakes D41227 ⇒) 240, 243, 253, 263 (4WD)	30/409-25	RH 3698735M91	1230 m
	30/409-26	LH 3698736M91	1510 m
350, 355, 360, 365, 375, 390, 398 (Freins concentriques ⇒ V39465 sans entretoise / Concentric brakes ⇒ V39465 without spacer)	30/409-4	RH 3595762M91	1247 m
	30/409-3	LH 3595763M91	1527 m
350, 355, 360, 365, 375, 390, 398, 399 (Freins concentriques ⇒ V39465 avec entretoise / Concentric brakes ⇒ V39465 with spacer)	30/409-2	RH 1696648M91	1097 m
	30/409-1	LH 1696649M91	1377 m
			
350, 355, 360, 365, 375, 390, 398 (Freins tangentiels V39466 ⇒ sans entretoise / Tangential brakes V39466 ⇒ without spacer) 362, 390T (Sans entretoise / Without spacer)	30/409-8	RH 3596774M92	1310 m
	30/409-7	LH 3596775M92	1590 m
350, 355, 360, 365, 375, 390, 398, 399 (Freins tangentiels V39466 ⇒ avec entretoise / Tangential brakes V39466 ⇒ with spacer) 340, 342, 352, 362N, 372N, 382N 362, 390T (Avec entretoise / With spacer) 362N, 382N (Cabine Hop - Allemagne / Hop cab - Germany) 396, 399 (Cabine profilée et tracteurs à bas profil / Low profile cab & footstep tractor)	30/409-6	RH 3596772M92	1160 m
	30/409-5	LH 3596773M92	1440 m
365, 375, 390, 390T (Cabine forestière / Forestry cab) 365, 390T, 396, 399 (Cabine Hi-Line / Hi-Line Cab)	30/409-6	RH 3596772M92	1160 m
	30/409-7	LH 3596775M92	1590 m
			
675, 690, 698, 698T, 699, 1004T	30/409-30	1693967M91	925 m
			
2620, 2640, 2680, 2720 (⇒ K256204)	30/409-31	3380064M1	505 m
			
2620, 2640, 2680, 2720 (K256205 ⇒) 2625, 2645, 2685, 2725	30/409-32	3383210M2	430 m

Les références des pièces sont indicatives.
Nos pièces ne sont pas d'origine

Part numbers are quoted for reference purposes only.
Our parts and accessories are not original.



**CABLES DE FREINS
BRAKE CABLES**

Tracteurs Tractors	Réf. Ref.	OEM	Longueur A Length A
			
3050, 3060, 3065	30/409-33	3581141M2	810 m
3050, 3060, 3065, 3070, 3080, 3085, 3090, 3095, 3115, 3125, 3140 (Avec cabine forestière / With forestry cab)	30/409-34	3583619M1	1405 m
3070, 3075, 3080, 3085, 3090, 3095, 3115, 3120, 3120T 3125, 3140	30/409-35	3581142M2	890 m
	30/409-36	3615160M2	945 m
3610, 3630, 3635, 3645, 3650, 3655, 3670, 3680, 3690	30/409-37	3581143M2	820 m
3635, 3645, 3655, 3670, 3690 (Avec cabine forestière / With forestry cab) 8110, 8120, 8130, 8140, 8150, 8160	30/409-38	3583620M2	1405 m
6110, 6120, 6130, 6140, 6150, 6160, 6170, 6180, 6190	30/409-39	3714536M1	1435 m
8110, 8120, 8130, 8150, 8160, 8210, 8220 (Phte-forme/ Platform)	30/409-40	3780289M1	1020 m
8170, 8180 (⇒ H091014) 8210, 8220, 8240, 8250 (Avec cabine / With cab)	30/409-41	3778741M1	1545 m
			
4215, 4220 4225, 4235, 4240, 4245, 4255, 4260, 4265, 4270, 4315, 4320, 4325, 4335, 4345, 4355, 4360, 4365, 4370 (Avec cabine / With cab)	30/409-44	3806187M91	2520 m
4225, 4235, 4240, 4245, 4255, 4260, 4265, 4270, 4315, 4320, 4325, 4335, 4345, 4355, 4360, 4365, 4370 (Tracteurs arch-pied / Footstep tractors)	30/409-45	3811660M91	1520 m
			
6160, 6170, 6180, 6190 (Phte-forme/ Platform) 6235, 6245, 6255, 6260, 6265, 6270, 6280, 6290	30/409-42	3778581M2	1090
8170, 8180 (H091015 ⇒) 8210, 8220, 8240, 8250 (Avec cabine / With cab) 8260, 8270, 8280	30/409-43	3782575M3	1520

Les références des pièces sont indicatives.
Nos pièces ne sont pas d'origine

Part numbers are quoted for reference purposes only.
Our parts and accessories are not original.



**CYLINDRES DE FREIN
BRAKE CYLINDERS**

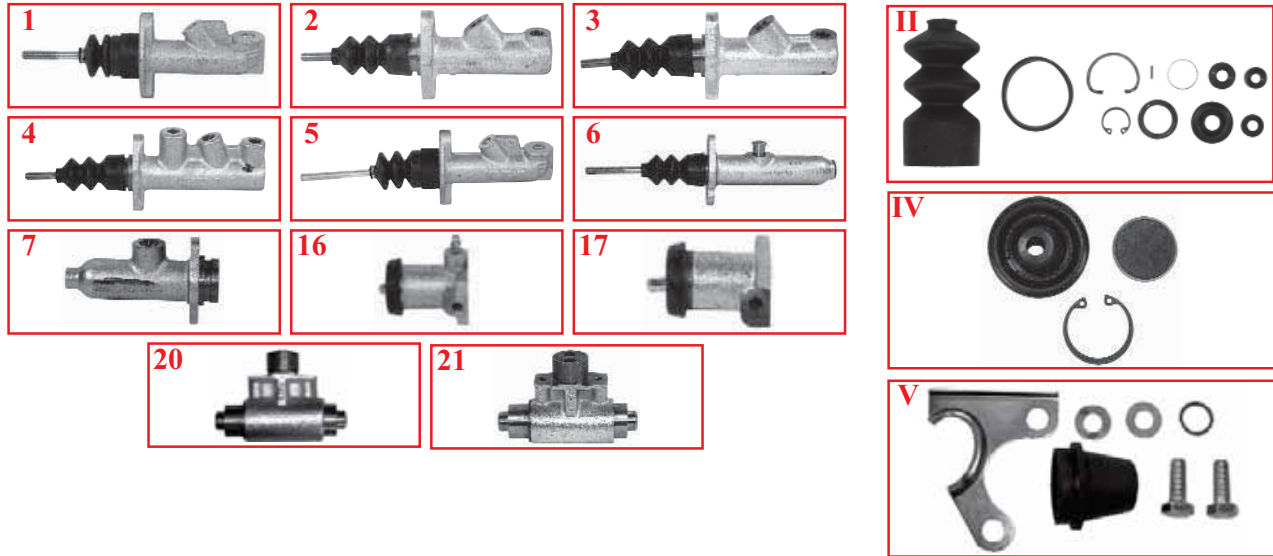

	I	II	III	IV	V
Tracteurs Tractors	Maître cyl. Master cyl.	Jeu de rép. Repair kit	Cyl. récepteur Slave cylinder	Jeu de rép. Repair kit	Jeu anti-poussière Dust cover kit
Tracteurs français & anglais / French & UK tractors					
235, 245, 250 255, 260, 290 (Germany ⇒ 1/80) 560 (⇒ A310)	1 30/410-1 (1698670M91)	30/411-1 (1810596M91)	16 30/413-1 (3186482M91)	30/414-1 (835939M91)	
255, 260, 290 (Germany 2/80 ⇒) 255, 260, 265, 275, 290, 298 560 (A311 ⇒)			17 30/413-2 (1676387M92)	30/414-2 (B41402)	
350, 355, 360, 365, 375, 390, 398, 399 Freins concentriques / Concentric brakes (⇒ V39465)	2 30/410-4 (3595504M2)	30/411-4 (1810849M91)		30/414-43 (1810881M91)	
350, 355, 360, 365, 375, 390, 398, 399 Freins tangentiels / Tangential brakes (V39466 ⇒) 340 342, 352, 362, 365, 375, 390, 390T, 398, 399 A marchepied avec cabne ⇒ S08141 Footstep, with cab ⇒ S08141	3 30/410-5 (3596785M92)	30/411-5 (1810936M91)	20 Gauch / LH 30/413-3 (3477380M93)	30/414-3 (1810917M94)	Gauch / LH 30/415-1 (1810992M91) Droit / RH 30/415-2 (1810993M91)
342, 352, 362, 365, 375, 390, 390T, 398, 399 A marchepied avec cabne S08142 ⇒ Footstep, with cab S08142 ⇒ 362N, 372N, 382N, 396			21 Droit / RH 30/413-4 (3477381M93)		
575, 590 (⇒ J121) 592, 595, 595MKII (⇒ A277031)	5 30/410-2 (1874957M91)	30/411-1 (1810596M91)	16 30/413-1 (3186482M91)	30/414-1 (835939M91)	
575, 590 (J122 ⇒) 592, 595, 595MKII (A277032 ⇒) 675, 690, 698 (Girling ⇒ 1984)			17 30/413-2 (1676387M92)	30/414-2 (B41402)	
675, 690, 698, 698T, 699, 1004, 1004T	6 30/410-3 (1682767M91)	30/411-3 (1810714M91)			
2620, 2625, 2640, 2645, 2680, 2685, 2720, 2725	7 30/410-6 (1613986M4)	30/411-6 (1642034M91)			

Les références des pièces sont indicatives.
Nos pièces ne sont pas d'origine

Part numbers are quoted for reference purposes only.
Our parts and accessories are not original.



CYLINDRES DE FREIN
BRAKE CYLINDERS



	I	II	III	IV	V
Tracteurs Tractors	Maître cyl. Master cyl.	Jeu de rép. Repair kit	Cyl. récepteur Slave cylinder	Jeu de rép. Repair kit	Jeu anti-poussière Dust cover kit
Tracteurs français & anglais / French & UK tractors					
Séries 3000,"3100,"3600," 6100,"6200" series 8110, 8120, 8130, 8140, 8150, 8160 Freins mécaniques, sans frein de remorque ou avec frein de remorque simple ligne Mechanical braking, without trailer brake or with trailer brake - one line	8	30/410-7 (3384685M3)	30/411-7 (1810832M91)		
Séries 3600" series 6190 6260, 6270, 6280, 6290 (⇒ 01/02) Séries 8100" series Séries 8200" series (⇒ 01/02) Freinage assisté, sans frein de remorque Power assisted braking, without trailer brake				22	Servopak 30/413-45 (3617596M1)
Séries 3000,"3100,"3600," 6100,"6200" series 8110, 8120, 8130, 8140, 8150, 8160 Freins mécaniques / Mechanical braking Avec frein de remorque double ligne With trailer brake - two lines	9	30/410-46 (3383079M5)	30/411-46 (1810833M91)		
Séries 3600" series 6190 6260, 6270, 6280, 6290 (⇒ 01/02) Séries 8100" series Séries 8200" series (⇒ 01/02) Freinage assisté, avec frein de remorque Power assisted braking, with trailer brake				22	Servopak 30/413-45 (3617596M1)
Séries 4200,"4300" series	10	30/410-47 (3810587M95)	30/411-47 (3901567M91)	23 Gauch / LH 30/413-43 (3901455M91) 24 Droit / RH 30/413-44 (3901456M91)	30/414-3 (1810917M94) Gauch / LH 30/415-1 (1810992M91) Droit / RH 30/415-2 (1810993M91)

Les références des pièces sont indicatives.
Nos pièces ne sont pas d'origine

Part numbers are quoted for reference purposes only.
Our parts and accessories are not original.



"THE RELIABLE SERVICE"



**CYLINDRES DE FREIN
BRAKE CYLINDERS**

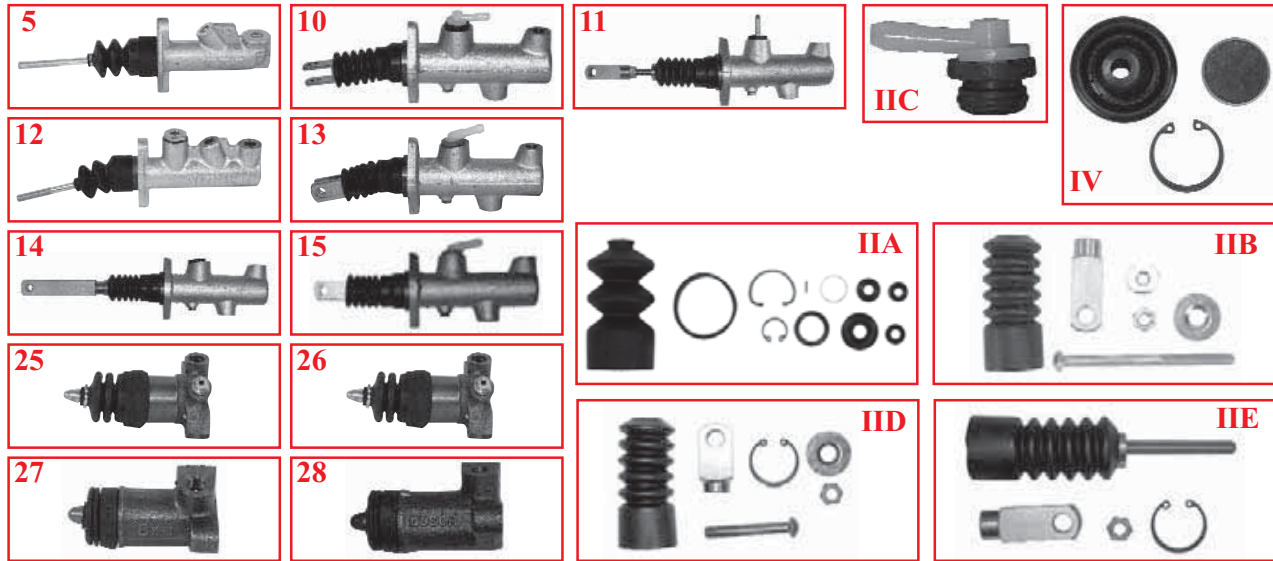

Tracteurs Tractors	I Maître cyl. Master cyl.	II Jeu de réparation / Repair kit		III Cyl. récepteur Slave cylinder	IV Jeu de réparation Repair kit
		Jeude joint Seal kit	Jeurép. Clevis kit		
IT Tracteurs italiens / Italian tractors					
134V, 154 F/S/V, 164T F/S/V, 174 F/S/V, 184 F/S, 194 F/S, 334V, 354 F/S/V, 364 F/S/V, 374 F-H/S/V, 384 F/S, 394 F-H/S	10	30/410-29 (3303732M92)	30/411-40 (IIA) (3302129M91)	30/411-42 (IIB) (3310351M91)	
254S, 264TS, 274S	11	30/410-43 (3301382M93)		25 30/413-22 (3302605M91)	30/414-40 (3302114M91)
274SK <i>Freins standards / Std brakes</i>	5	30/410-2 (1874957M91)	30/411-1 (IIA) (1810596M91)		
274SK <i>Freins sur transmission With brakes on transmission</i>	12	30/410-28 (3305623M92)	30/411-23 (IIA) (1810687M91)		
284S				26 30/413-24 (785625M92)	30/414-44 (1810573M91)
294S <i>Preiniars anciens / Early</i>	5	30/410-2 (1874957M91)	30/411-1 (IIA) (1810596M91)		
294S <i>Derniers anciens / Late</i>	12	30/410-28 (3305623M92)	30/411-23 (IIA) (1810687M91)	25 30/413-22 (3302605M91)	30/414-40 (3302114M91)
354, 364, 374, 384, 394, 394T <i>Modèles / Models AQFQSQVQAP, FP, GE, SP,</i>			30/411-45 (IIC) (3540224M91)		
354, 364, 374, 384, 394, 3210, 3220, 3225, 3235 <i>Modèles / Models AP(X), FP(X), GE(X), SP(X) & A archepied / Footstep</i>	13	30/410-27 (3537810M91)	Jeutpu Pipe kit	30/411-43 (IID) (3540223M91)	27 30/413-10 (3537812M91)
2205, 2210, 2220, 2230					
377, 387, 397, 397T, 1007 <i>Sans freinage avant / Without front braking</i>	12	30/410-28 (3305623M92)	30/411-41 (IIA) (1810748M91)	25 30/413-22 (3302605M91)	30/414-40 (3302114M91)
377, 387, 397, 397T, 1007 <i>Avec freinage avant / With front braking</i>	14	30/410-44 (3536279M92)	30/411-40 (IIA) (3302129M91)	30/411-44 (IIE) (3311649M92)	28 30/413-40 (3536401M91)
1014, 1024, 1114, 1134 <i>Preiniars anciens / Early</i>	5	30/410-2 (1874957M91)	30/411-1 (IIA) (1810596M91)		
1014, 1024, 1114, 1134 <i>Derniers anciens / Late</i>	12	30/410-28 (3305623M92)	30/411-41 (IIA) (1810748M91)	25 30/413-24 (785625M92)	30/414-44 (1810573M91)
3315, 3325, 3330, 3340, 3350, 3355	15	30/410-45 (0.009.9234.4)	30/411-48 (IIA) (0.009.4674.0)		

Les références des pièces sont indicatives.
Nos pièces ne sont pas d'origine



















Part numbers are quoted for reference purposes only.
Our parts and accessories are not original.



"THE RELIABLE SERVICE"



BOULONS DE ROUES ARRIÈRES
REAR WHEEL BOLTS

Tracteurs Tractors	Réf. goujon Bolt number	Illustration goujon Bolt illustration	Illustr. écrou Nut illustr.	Réf. écrou Nut number
Tracteurs français, anglais, américains / French, UK, USA tractors				
TEA20, TED20, TEF20, TEH20, 35, 122, 130, 133, 135, 140, 148, 230, 235, 240, 245, 250, 340, 342, 550, 835 (Ponts à entraînement direct / <i>Direct drive axles</i>)	30/440-1 (185400M2)	 9/16"UNF x 50 m		30/441-1 (180004M1)
65, 133, 135, 140, 145, 152, 155, 158, 165, 168, 175, 178, 185, 188, 240, 250, 255, 260, 265, 275, 285, 290, 560, 565, 575, 590, 675, 690, 698, 765, 865, 1080, 1200 (Ponts épicycloïdaux / <i>Epicyclic axles</i>)	30/440-3 (893017M2)	 5/8"UNF x 55 m		30/441-2 (184273M1) 30/441-3 (881162M2)
135, 145, 152, 158, 168, 185, 240, 243, 250, 253, 263, 275E, 290, 290E, 298, 350, 352, 355, 360, 362, 362N, 365, 372N, 375, 375E, 382N, 390, 390E, 390T, 396, 398, 399, 575, 590, 592, 595, 595MKII, 675, 690, 698, 698T, 699, 1004, 1004T, 1250, 4215, 4220, 4225, 4235, 4240, 4245, 4255, 4260, 4265, 4270, 4315, 4320, 4325, 4335, 4345, 4355, 4360, 4365, 4370	30/440-12 (847416M1)	 11/16"UNF x 60 m		30/441-12 (847417M1) PAVT 30/441-32 (1872458M1)
595, 595MKII, 1080	30/440-32 (1808819M1)	 5/8"UNF x 60 m		30/441-2 (184273M1)
3050, 3060, 3065, 3070, 3075, 3080, 3085, 3090, 3095, 3120, 3125, 6110, 6120, 6130, 6140, 6150, 6160, 6170, 6180, 6190, 6235, 6245, 6255, 6260, 6265, 6270, 6280, 6290	30/440-36 (3384602M4)	 M18x1.5 x 65 m		30/441-35 (3384600M2)
3115, 3610, 3630, 3635, 3645, 3650, 3655, 3660, 3670, 3680, 3690, 8110, 8120, 8130, 8140, 8150, 8160, 8210, 8220, 8240, 8250	30/440-37 (3384601M4)	 M18x1.5 x 92 m		30/441-37 (3384597M1)
Tracteurs italiens / Italian tractors				
154, 174, 184, 194, 194F, 234S, 253, 254, 254S, 263T, 264T, 273, 274, 274 S/SK, 283, 284, 284S, 293, 294, 294S, 333, 353, 353 LX/S, 363, 363 LX/S, 373, 373 LX/S, 377, 383, 383 LX/S, 387, 393, 393 LX/S/TLX, 397, 397T, 1007, 1114, 1134 354, 364, 374, 384, 394 modèles GE & Q <i>models</i> 2205, 2210, 2220, 2225, 2230, 2235 3210, 3220, 3225, 3235 modèles GE <i>models</i> (Disques en tôle / <i>Sheet metal discs</i>)	30/440-33 (1434760M1)	 M18x1.5 x 55 m		30/441-33 (392501X1) A flâsq / Flanged 30/441-35 (3384600M2)
184, 194, 254, 264T, 274, 274SK, 283, 284, 284S, 293, 294, 294S, 333, 353, 353 LX/S, 363, 363 LX/S, 373, 373 LX/S, 377, 383, 383 LX/S, 387, 393, 393 LX/S/TLX, 397, 397T, 1007, 1104 354, 364, 374, 384 modèles VQ <i>models</i> (Disques en fonte / <i>Cast iron discs</i>)	30/440-35 (975124M1)	 M18x1.5 x 70 m		
134V, 154 F/S/V, 164T F/S/V, 174 F/S/V, 184 F/S, 194 F/S, 334V 354, 364, 374, 384, 394, 3210, 3220, 3225, 3235 modèles AP/AQ/FP/FQ/SP/SQ <i>models</i>	30/440-38 (3304220M1)	 M18x1.5 x 70 m		30/441-35 (3384600M2)

Les références des pièces sont indicatives.
Nos pièces ne sont pas d'origine

Part numbers are quoted for reference purposes only.
Our parts and accessories are not original.



GOUJONS ET ECROUS DE JANTES
RIM TO DISC BOLTS

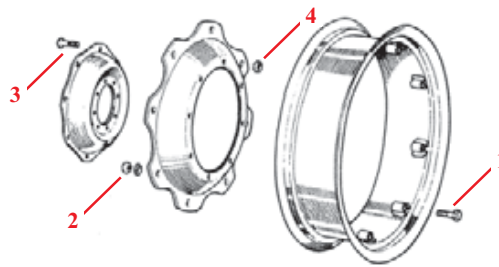

	1		2	
Tracteurs Tractors	Réf. goujon Bolt number	Illustration goujon Bolt illustration	Illustr. écrou Nut illustr.	Réf. écrou Nut number
Tracteurs français, anglais, américains / French, UK, USA tractors				
25, 35, 65, 122, 130, 133, 135, 140, 145, 148, 152, 155, 158, 165, 168, 175, 178, 185, 188, 230, 240, 250, 255, 260, 265, 275, 285, 290, 298, 550, 560, 565, 575, 590, 595, 595MKII, 675, 690, 698, 765, 825, 835, 865, 1080, 1200, 1250, 2620, 2625, 2640, 2645, 2680, 2685, 2720, 2725, 3610, 3630, 3650	30/442-1 (828217M1)	 5/8"UNF x 72 m		30/443-1 (353427X1)
135, 145, 148, 152, 158, 165, 168, 188, 235, 245, 250, 255, 265, 275, 290, 298, 560, 575, 590, 675, 690, 698, 1004	30/442-10 (377749X1)	 5/8"UNF x 70 m		
65, 133, 135, 145, 148, 152, 155, 158, 165, 168, 175, 178, 188, 240, 250, 260, 265, 275, 285, 290, 560, 565, 575, 590, 675, 690 <i>disq-disq / disc-disc</i>	30/442-11 (3) (827854M1)	 9/16"UNF x 35 m		30/441-1 (4) (180004M1)
133, 135, 145, 148, 152, 158, 168, 235, 245, 250, 255, 265, 275, 275E, 290, 290E, 298, 355, 362, 365, 375, 375E, 382, 382N, 390, 390E, 390T, 398, 560, 565, 575, 590, 675, 690, 698, 698T, 699, 1004, 1004T, 1200, 1250, 2620, 2625, 2640, 2645, 2680, 2685, 2720, 2725, 3050, 3060, 3065, 3070, 3075, 3080, 3085, 3090, 3095, 3115, 3120, 3120T, 3125, 3140, 3610, 3630, 3635, 3645, 3650, 3655, 3660, 3670, 3680, 3690, 6110, 6120, 6130, 6140, 6150, 6160, 6170, 6180, 6190, 6235, 6245, 6255, 6260, 6265, 6270, 6280, 6290, 8110, 8120, 8130, 8140, 8150, 8160, 8210, 8220, 8240, 8250, 8260	30/442-12 (A) (3384620M1)	 M16x1.5 x 80 m		30/443-6 (1440231X1)
298, 592, 595, 595MKII, 675, 690, 698, 698T, 699, 1004, 1004T, 2620, 2625, 2640, 2645, 2680, 2685, 2720, 3050, 3060, 3065, 3070, 3075, 3080, 3085, 3090, 3095, 3115, 3120, 3120T, 3125, 3140, 3610, 3630, 3635, 3645, 3650, 3655, 3660, 3670, 3680, 3690, 6110, 6120, 6130, 6140, 6150, 6160, 6170, 6180, 6190, 6235, 6245, 6255, 6260, 6265, 6270, 6280, 6290, 8110, 8120, 8130, 8140, 8150, 8160, 8210, 8220	30/442-13 (3384624M1)	 M16x1.5 x 125 m		
230, 240, 243, 253, 263, 275E, 290E, 340, 342, 350, 352, 360, 362N, 365, 372N, 375, 375E, 382N, 390, 390E, 390T, 396, 398, 399, 4215, 4220, 4225, 4235, 4240, 4245, 4255, 4260, 4265, 4270, 4315, 4320, 4325, 4335, 4345, 4355, 4360, 4365, 4375	30/442-14 (1688527M1)	 M16x2.0 x 78 m		30/443-7 (339034X1)
240, 250, 253, 265, 275, 275E, 290, 290E, 340, 342, 350, 352, 355, 360, 362N, 365, 372N, 375, 375E, 382N, 390, 390E, 390T, 396, 398, 399, 675, 690, 4215, 4220, 4225, 4235, 4240, 4245, 4255, 4260, 4265, 4270	30/442-15 (1684905M1)	 M16x2.0 x 121 m		

(A) Les vis 5/8"UNF 377918X1, 1895270M1 et 3381010M1 sont remplacés par **30/442-12** (3384620M1) + **30/443-6** (1440231X1)
(A) 5/8" UNF bolts 377918X1, 1895270M1 and 3381010M1 are replaced by **30/442-12** (3384620M1) + **30/443-6** (1440231X1)

Les références des pièces sont indicatives.
Nos pièces ne sont pas d'origine













Part numbers are quoted for reference purposes only.
Our parts and accessories are not original.







"THE RELIABLE SERVICE"

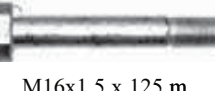

GOUJONS ET ECRUS DE JANTES
RIM TO DISC BOLTS

Tracteurs Tractors	1		2	
	Réf. goujon Bolt number	Illustration goujon Bolt illustration	Illustr. écrou Nut illustr.	Réf. écrou Nut number
Tracteurs français, anglais, américains / French, UK, USA tractors				
240, 243, 253, 263, 275E, 290E, 362, 365, 375, 375E, 390, 390E, 390T, 398, 399, 4215, 4220, 4225, 4235, 4240, 4245, 4255, 4260, 4265, 4270, 4315, 4320, 4325, 4335, 4345, 4355, 4360, 4365, 4370	30/442-16 (3815980M1)	 M16x2.0 x 75 m		30/443-8 (3815981M1)
253, 263, 290E, 362, 365, 375, 390, 390E, 390T, 4215, 4220, 4225, 4235, 4240, 4245, 4255, 4260, 4265, 4270, 4315, 4320, 4325, 4335, 4345, 4355, 4360, 4365, 4370	30/442-17 (3816970M1)	 M16x1.5 x 58 m		30/443-13 (3816971M1)
4225, 4235, 4240, 4245, 4255, 4260, 4265, 4270, 4315, 4320, 4325, 4335, 4345, 4355, 4360, 4365, 4370	30/442-18 (3827534M1)	 M16x1.5 x 80 m		30/443-9 (3785846M1)
3085, 3095, 3115, 3125, 3140, 3610, 3630, 3635, 3645, 3650, 3655, 3660, 3670, 3680, 3690, 6190, 6280, 6290, 8110, 8120, 8130, 8140, 8150, 8160, 8170, 8180, 8210, 8220, 8240, 8250, 8260, 8270, 8280	30/442-19 (3384603M1)	 M18x1.5 x 95 m		30/441-35 (3384600M2)
Tracteurs italiens / Italian tractors				
174, 184, 194, 194F, 253, 263T, 264T, 264TS, 273, 274, 274SK, 283, 284, 284S, 293, 294, 294S, 363, 363S, 373, 373S, 374H, 377, 383, 383S, 387, 393, 393S, 394H, 397, 397T, 1007, 3220H, 3235H	30/442-22 (395542X1)	 M18x1.5 x 45 m		30/443-10 (392420X1)
353, 353 LX/S, 363, 363 LX/S, 373, 373 LX/S, 383, 383 LX/S, 393, 393 LX/S/TLX	30/442-12 (3384620M1)	 M16x1.5 x 80 m		30/443-6 (1440231X1)
363, 363 LX/S, 373, 373 LX/S, 377, 383, 383 LX/S, 387, 393, 393 LX/S/TLX, 397, 397T, 1007	30/442-13 (3384624M1)	 M16x1.5 x 125 m		

BOULONS ADAPTATEURS ROUES JUMEEES
DUAL WHEEL ADAPTOR BOLTS

Tracteurs Tractors	Réf. adaptat. Adapt. number	Illustration adaptateur Adaptor illustration	Illustr. écrou Nut illustr.	Réf. écrou Nut number
TEA20, TED20, TEF20, TEH20, 35, 133, 135, 140, 148, 230, 235, 240, 245, 340, 342, 550, 835	30/439-1 (818017M1)	 9/16"UNF x 70 m		30/441-1 (180004M1)
65, 158, 165, 168, 175, 178, 185, 188, 565, 575, 765, 865	30/439-2 (1863857M1)	 5/8"UNF x 80 m		30/441-3 (881162M2)

Les références des pièces sont indicatives.
Nos pièces ne sont pas d'origine

Part numbers are quoted for reference purposes only.
Our parts and accessories are not original.



ROUES A VOIES VARIABLES AVANTS ET ARRIERES
POWER ASSISTED VARIABLE TRACK - REAR & FRONT WHEELS

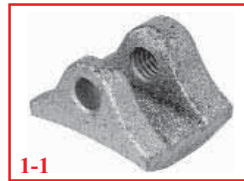
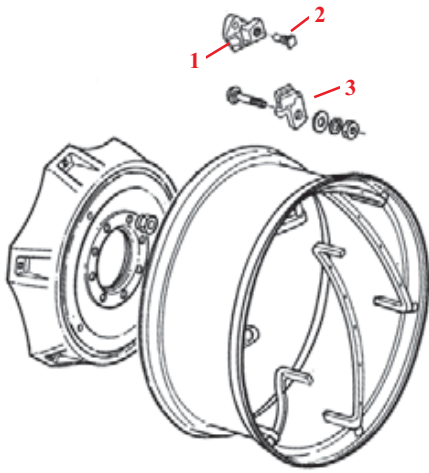

	1	2	3
Tracteurs Tractors	Taquet Stop	Vis Screw	Bride Clamp
Tracteurs français, anglais, américains / French, UK, USA tractors			
175, 178, 185, 188, 275, 275E, 290, 290E, 298, 362, 365, 375, 375E, 390, 390E, 390T, 396, 398, 399, 590, 690, 3050, 3060, 3065, 3070, 3080, 3090, 4225, 4235, 4240, 4245, 4255, 4260, 4265, 4270, 4325, 4335, 4345, 4355, 4360, 4365, 4370	30/436-1 (1-1) (898022M2)		
133, 135, 140, 145, 148, 152, 155, 158, 165, 168, 178, 185, 188, 230, 240, 243, 253, 263, 275, 285, 290, 298, 362, 365, 375, 390, 390T, 396, 398, 399, 575, 590, 595, 595MKII, 690, 698, 698T, 1004T, 1080, 1085, 1100, 1105, 1130, 1135, 2620, 2640, 2645, 2675, 2680, 2685, 2705, 2720, 2725, 3050, 3060, 3065, 3070, 3075, 3080, 3085, 3090, 3095, 3115, 3120, 3120T, 3125, 3140, 3610, 3630, 3635, 3645, 3650, 3655, 3660, 3670, 3680, 3690, 4225, 4235, 4240, 4245, 4255, 4260, 4265, 4270, 4325, 4335, 4345, 4355, 4360, 4365, 4370, 6150, 6160, 6170, 6180, 6190, 6235, 6245, 6255, 6260, 6265, 6270, 6280, 6290, 8110, 8120, 8130, 8140, 8150, 8160	30/436-2 (1-2) (503676M1)	30/437-1 (2-1) (1751403M1)	30/438-1 (3-1) (3615259M2)
Tracteurs italiens / Italian tractors			
134V, 154 F/S/V, 164T F/S/V, 174 F/S/V, 184 F/S, 194 F/S, 284S 294S (Preïr / Early)	30/436-2 (1-2) (503676M1)	30/437-1 (2-1) (1751403M1)	30/438-1 (3-1) (3615259M2)
184, 194, 274SK, 283, 284, 293, 294, 374H, 377, 383, 383 LX/S, 387, 393, 393 LX/S/TLX, 394H, 397, 397T, 1007, 1134, 3220H, 3235H 294S (Dernier / Late)	30/436-3 (1-3) (3531378M1)	30/437-2 (2-2) (3531379M1)	
334V 354, 364, 374, 384, 394, 3210, 3220, 3225, 3235 modèles AP/AQ/FP/FQ/H/S/SP/SQ/V/Q models 1114, 1134 (Avant / Front)	30/436-2 (1-2) (503676M1)	30/437-1 (2-1) (1751403M1)	30/438-2 (3-2) (3531377M1)

Les références des pièces sont indicatives.
Nos pièces ne sont pas d'origine

Part numbers are quoted for reference purposes only.
Our parts and accessories are not original.



"THE RELIABLE SERVICE"



ROUES A VOIES VARIABLES AVANTS ET ARRIERES - GOUJONS DE JANTE
POWER ASSISTED VARIABLE TRACK - RIM / DISC BOLTS - REAR & FRONT WHEELS

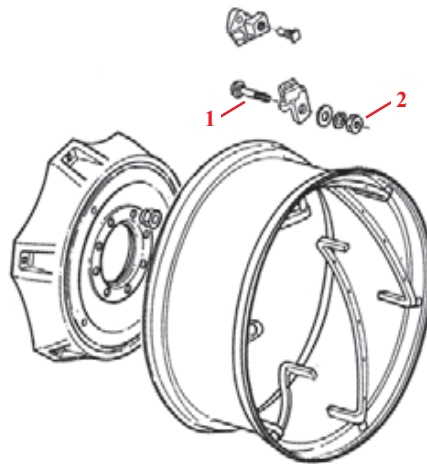















	1		2	
Tracteurs Tractors	Réf. goujon Bolt number	Illustration goujon Bolt illustration	Illustr. écrou Nut illustr.	Réf. écrou Nut number
Tracteurs français, anglais, américains / French, UK, USA tractors				
133, 135, 140, 145, 152, 155, 158, 168, 175, 178, 185, 188, 230, 240, 243, 253, 263, 275, 285, 290, 298, 360, 375, 390, 390T, 396, 398, 399, 575, 590, 595, 595MKII, 690, 698, 698T, 699, 1004, 1080, 1085, 1100, 1105, 1130, 1135, 2620, 2640, 2645, 2675, 2680, 2685, 2705, 2720, 2725, 4225, 4235, 4240, 4245, 4255, 4260, 4265, 4270, 4325, 4335, 4345, 4355, 4360, 4365, 4370	30/442-20 (364012X1)	 3/4"UNC x 95 m		30/741-3 (375100X1)
168, 175, 178, 185, 188, 275, 275E, 285, 290, 290E, 298, 362, 365, 375, 375E, 390, 390E, 390T, 396, 398, 399, 590, 595, 595MKII, 690, 698, 698T, 699, 1080, 2640, 2645, 2680, 2685, 2720, 2725, 3610, 3630, 3650, 4225, 4235, 4240, 4245, 4255, 4260, 4265, 4270, 4325, 4335, 4345, 4355, 4360, 4365, 4370	30/442-6 (363296X1)	 3/4"UNC x 114 m		
3050, 3060, 3065, 3070, 3075, 3080, 3085, 3090, 3095, 3115, 3120, 3120T, 3125, 3140, 3610, 3630, 3635, 3645, 3650, 3655, 3660, 3670, 3680, 3690, 6150, 6160, 6170, 6180, 6190, 6235, 6245, 6255, 6260, 6270, 6280, 6290, 8110, 8120, 8130, 8140, 8150, 8160	30/442-19 (3384603M1)	 M18x1.5 x 95 m		30/441-35 (3384600M2)
Tracteurs italiens / Italian tractors				
184, 194, 284S 274SK, 294S (Preinr / Early)	30/442-20 (364012X1)	 3/4"UNC x 95 m		30/741-3 (375100X1)
134V, 154 F/S/V, 164T F/S/V, 174 F/S/V, 184 F/S, 194 F/S, 283, 284, 293, 294 274SK, 294S (Dernier / Late) 334V, 377, 383, 383 LX/S, 387, 393, 393 LX/S/TLX, 397, 397T, 1007, 1134 354, 364, 374, 384, 394, 3210, 3220, 3225, 3235 modèles AP/AQ/FP/FQ/HS/SP/SQ/VQ models	30/442-21 (3306589M1)	 M20x2.5 x 95 m		30/443-12 (3009747X1)
1114, 1134 (Avant / Front)	30/442-6 (363296X1)	 3/4"UNC x 114 m		30/741-3 (375100X1)

Les références des pièces sont indicatives.
Nos pièces ne sont pas d'origine

Part numbers are quoted for reference purposes only.
Our parts and accessories are not original.



**BOULONS DE ROUES AVANTS
FRONT WHEEL BOLTS**

















Tracteurs Tractors	Réf. goujon Bolt number	Illustration goujon Bolt illustration	Illustr. écrou Nut illustr.	Réf. écrou Nut number
Tracteurs français, anglais, américains - 2RM / French, UK, USA tractors - 2WD				
TEA20, TED20, TEF20, TEH20 35 (⇒ 368615), 835 65, 765 (⇒ 601684), 865 122, 130, 133, 135, 140, 145, 165 (France - Preitr / Early) 135 (UK ⇒ 113858), 165 (UK ⇒ 560652) <i>Non renforcé / Normal duty</i>	30/446-1 (181328M1)	 1/2"UNF x 35 m		30/447-1 (195490M1)
122, 130, 133, 135, 140, 145, 165 (France - Dernier / Late) 135 (UK 113859 ⇒), 165 (UK 560653 ⇒) 148, 152, 155, 158, 168, 230, 235, 240, 243, 245, 250, 253, 255, 260, 263, 265, 275, 340, 342, 350, 550, 560, 565, 4215, 4220 <i>Non renforcé / Normal duty</i>	30/446-2 (887135M1, 906863M1)	 1/2"UNF x 25 m		
65, 165, 168, 175 (746276 ⇒), 175S, 178, 185, 188, 253, 263, 265, 275, 275E, 285, 290, 290E, 350, 352, 355, 360, 362, 362N, 365, 372N, 375, 375E, 390, 390E, 390T, 396, 398, 399, 565, 575, 590, 592, 595, 595MKII, 675, 690, 765, 1080, 1100, 1130, 4215, 4220, 4225, 4235, 4240, 4245, 4255, 4260, 4265, 4270, 4315, 4320, 4325, 4335, 4345, 4355, 4360, 4365, 4370 <i>Renforcé / Heavy duty</i>	30/446-3 (831420M1)	 1/2"UNF x 44 m		30/447-1 (195490M1)
298, 698, 698T, 699, 1080, 1085, 1100, 1105, 1130, 1135, 2620, 2625, 2640, 2645, 2680, 2685, 2720, 2725, 3050, 3060, 3065, 3070, 3075, 3080, 3085, 3090, 3095, 3115, 3125, 3610, 3630, 3645, 3650, 3655, 6110, 6120, 6130, 6140, 6150 (<i>Moyu6 trous / 6 hole hub</i>)	30/446-30 (518611M1)	 9/16"UNF x 22 m		
2640, 2645, 2680, 2685, 2720, 2725 (USA) 3070, 3075, 3080, 3085, 3090, 3095, 3115, 3120, 3125, 3140, 3610, 3630, 3645, 3650, 3660, 3670, 3680, 3690, 6150, 6160, 6170, 6180, 6190, 6235, 6245, 6255, 6260, 6265, 6270, 6280, 6290, 8110, 8120, 8130, 8140, 8150, 8160, 8210, 8220, 8240 (<i>Moyu8 trous / 8 hole hub</i>)	30/440-34 (1823598M1)	 M16x1.5 x 35 m		
Tracteurs français, anglais, américains - 4RM / French, UK, USA tractors - 4WD				
250, 265, 275, 285, 290, 298, 575, 590, 675, 690, 698, 698T, 699, 1004, 1004T	30/440-34 (1823598M1)	 M16x1.5 x 35 m		
168, 188 (<i>Pont type 1972 type axle</i>) 275, 285, 298, 575, 590, 592, 595, 595MKII, 698, 2620, 2625, 2640, 2645, 2680, 2685, 2720, 2725 3610, 3630, 3650 (<i>Angle de bage 40° 40° turning angle</i>)	30/440-39 (2714633M4) PAVT 30/440-40 (2714631M4)	 M18x1.5 x 60 m  M18x1.5 x 110 m		30/441-33 (392501X1)
340, 350, 355, 360, 362, 365, 375, 390, 390T, 396, 398, 399 <i>Ponts NG / NG axles</i>	30/440-41 (3599253M1)	 M18x1.5 x 35 m		
240, 243, 253, 263, 275E, 290E, 342, 352, 362, 362N, 365, 372N, 375, 375E, 382N, 390, 390E, 390T, 396, 398, 399, 3050, 3060, 3065, 3075, 3085, 4215, 4220, 4225, 4235, 4240, 4245, 4255, 4260, 4265, 4270, 4315, 4320, 4325, 4335, 4345, 4355, 4360, 4365, 4370, 6110, 6120, 6130, 6140, 6150, 6160, 6235, 6245, 6255, 6260, 6265 <i>Ponts AG / AG axles</i>	30/440-42 (3428238M3)	 M18x1.5 x 60 m	 	UK 30/441-27 (3699444M1) France 30/441-35 (3384600M2)

Les références des pièces sont indicatives.
Nos pièces ne sont pas d'origine

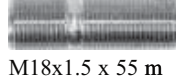
Part numbers are quoted for reference purposes only.
Our parts and accessories are not original.



BOULONS DE ROUES AVANTS
FRONT WHEEL BOLTS

Tracteurs <i>Tractors</i>	Réf. goujon <i>Bolt number</i>	Illustration goujon <i>Bolt illustration</i>	Illustr. écrou <i>Nut illustr.</i>	Réf. écrou <i>Nut number</i>
Tracteurs français, anglais, américains - 4RM / French, UK, USA tractors - 4WD				
3050, 3060, 3065, 3070, 3075, 3080, 3085, 3090, 3095, 3115, 3120, 3120T, 3125, 3140, 3610, 3630, 3635, 3645, 3650, 3655, 3660, 3670, 3680, 3690, 6110, 6120, 6150	30/440-45 (3384595M2)	 M18x1.5 x 70 m		30/441-35 (3384600M2)
3095, 3120, 3635, 3645, 3655, 3670, 3690, 6170, 6180, 6190, 6270, 6280, 6290, 8110, 8120, 8130, 8140, 8150, 8160, 8210, 8220, 8240, 8250, 8260	30/440-43 (3428141M3)	 M22x1.5 x 70 m		30/441-38 (3712611M2)
Tracteurs italiens - 2RM / Italian tractors - 2WD				
134V, 154, 154 F/S/V, 164T F/S/V, 174, 174 F/S/V, 184, 184 F/S, 194, 194 F/S, 233, 234S, 253, 254, 263T, 264T, 264 T/S, 273, 274, 274 S/SK, 284S, 294S, 333, 334V, 353, 353 LX/S, 363, 363 LX/S, 373, 373 LX/S, 377, 387, 397 354, 364, 374, 384, 394, 3210, 3220, 3225, 3235 <i>Tous modèles / All models</i> 2205, 2210, 2220, 2225, 2230, 2235	30/446-31 (1441554X1)	 M14x1.5 x 30 m		
273, 283, 284, 293, 294, 294S, 377, 383, 383 LX/S, 387, 393, 393 LX/S/TLX, 397, 397T, 1007	30/446-32 (391870X1)	 M14x1.5 x 35 m		
Tracteurs italiens - 4RM / Italian tractors - 4WD				
154, 174, 184, 194, 253, 254, 254S, 263T, 263TS, 273, 274, 274 S/SK, 284, 284S, 294, 294S, 374H, 394H, 3220H, 3235H 1014, 1024 (<i>Preîar / Early</i>)	30/440-34 (1823598M1)	 M16x1.5 x 35 m		
154 F/S/V, 164T F/S/V, 174 F/S/V, 184 F/S, 194 F/S, 334V 354, 364, 374, 384, 394, 3210, 3220, 3225, 3235 <i>Tous modèles / All models</i>	30/440-44 (3303567M1)	 M16x1.5 x 65 m		30/441-39 (3009748X1)
283, 293, 353, 353 LX/S, 363, 363 LX/S, 373, 373 LX/S, 377, 383, 383 LX/S, 387, 393, 393 LX/S/TLX, 397, 397T, 1007 284, 294, 294S (<i>Voie variab / Changeable track</i>) 1014, 1024, 1114, 1134 (<i>Dernier / Late</i>)	30/440-38 (3304220M1)	 M18x1.5 x 70 m		30/441-35 (3384600M2)
353LX, 363, 363 LX/S, 373, 383, 387, 397 <i>Fixation par goujon / Stud fixing</i>	30/440-33 (1434760M1)	 M18x1.5 x 55 m		
1114, 1134 (<i>Preîar / Early</i>)	30/440-39 (2714633M4) PAVT 30/440-40 (2714631M4)	 M18x1.5 x 60 m  M18x1.5 x 110 m		30/441-33 (392501X1)
Tracteurs industriels / Industrial tractors				
50, 50B, 50B MKII, 50D;50E, 50EX, 50H, 50HX, 60H	30/446-12 (882572M1)	 5/8"UNF x 48 m		30/441-2 (184273M1)

Les références des pièces sont indicatives.
Nos pièces ne sont pas d'origine



"THE RELIABLE SERVICE"



*Part numbers are quoted for reference purposes only.
Our parts and accessories are not original.*

**JANTES AVANTS 2RM
FRONT WHEELS 2WD**



Tracteurs Tractors	Roue avant Front wheel				
Dimension de la jante / Wheel size	4.50 x 16"	4.50 x 19"	5.50 x 16"	5.50 x 18"	6.50 x 16"
Dimension du pneu Tyre size	6.00 x 16" 6.50 x 16"	6.00 x 19"	6.50 x 16" 7.50 x 16"	7.50 x 18"	9.00 x 16"
TEA20, TED20, TE F20, TEH20, 35, 122, 130, 835	30/449-2 (885741T2)	30/449-16 (885599M92)	30/449-3 (1691618M92)		
65, 765, 865					
133, 135, 140, 145, 148, 152					
155, 158, 165, 168					
175, 178, 185, 188					
230, 243, 253, 260, 263	30/449-2 (885741T2)	30/449-16 (885599M92)	30/449-3 (1691618M92)		
235, 240, 245, 250, 255					
265					
275, 275E, 285, 290, 290E				30/449-4 (3827583M91)	30/449-17 (1671829M91)
298					
340					
342, 350, 352, 355, 372N	30/449-2 (885741T2)	30/449-16 (885599M92)	30/449-3 (1691618M92)	30/449-4 (3827583M91)	
362, 362N, 365, 375, 375E, 390, 390E, 390T					
398, 399					
550	30/449-2 (885741T2)	30/449-16 (885599M92)	30/449-3 (1691618M92)		
560					
565, 575, 590		30/449-16 (885599M92)			30/449-17 (1671829M91)
592, 595, 595MKII, 1080					
675, 690					30/449-17 (1671829M91)
698, 698T, 699, 3050, 3060, 3065, 3070, 3080, 3090					
4215, 4220, 4225, 4315, 4320, 4325	30/449-2 (885741T2)	30/449-16 (885599M92)	30/449-3 (1691618M92)	30/449-4 (3827583M91)	
4235, 4240, 4245, 4255, 4260, 4265, 4270, 4335, 4345, 4355, 4365					
4360, 4370					
6130, 6150					

Les références des pièces sont indicatives.
Nos pièces ne sont pas d'origine

Part numbers are quoted for reference purposes only.
Our parts and accessories are not original.



"THE RELIABLE SERVICE"



PIÈCES D'AVANT-TRAIN 2 RM
FRONT AXLE PARTS 2 WD

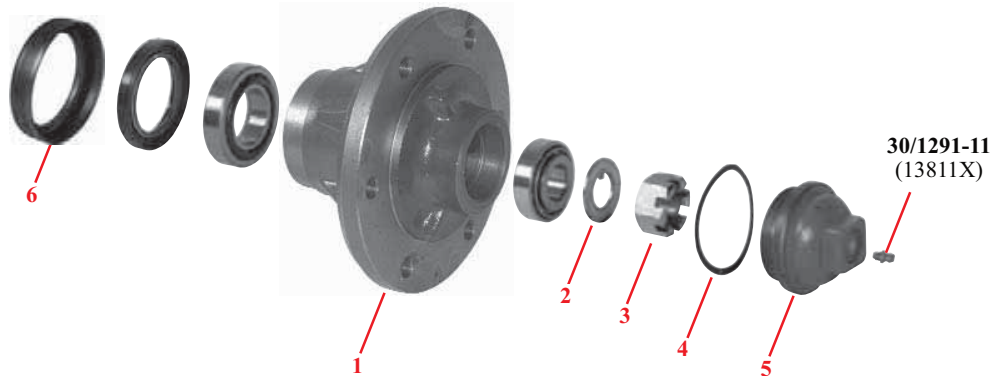

	1	2	3	4	5	6
Tracteurs Tractors	Moyeu Front Hub	Rondelle Tab washer	Ecrou Castle nut	Joint Gasket	Bouchon Hub cap	Anti-poussière Dust shield
Tracteurs français, anglais, américains - Standards / French, UK, USA tractors - Normal duty						
TEA20, TED20, TEF20, TEH20, 35 (⇒ 368615), 835, 65, 765 (⇒ 601684), 865, 65MKII, 165 (France), 122, 130 (UK)	30/450-1 (898085M91)					
35 (368616 ⇒), 65, 765 (601685 ⇒), 133, 135, 140, 148 (UK), 135S, 145S, 152S, 158S (⇒ S253018), 145 (⇒ 664499), 165 (UK), 165MKIII (France), 168	30/450-2 (886336M1)	30/451-1 (180010M1)	30/452-1 (353928X1)	30/453-1 (646059M1)	30/454-1 (191142M1)	30/473-1 (897232M1)
122, 130, 133, 135, 140, 148, 152, 155, 158 (France), 135S, 145S, 152S, 158S (S253019 ⇒), 145 (664500 ⇒)	30/450-11 (963519M1)		30/452-16 (963534M1)		30/454-7 (623139M1)	
175, 178						
230, 235, 240, 245, 250, 255, 260, 265, 275, 550, 560, 565	30/450-2 (886336M1)	30/451-1 (180010M1)	30/452-1 (353928X1)	30/453-1 (646059M1)	30/454-1 (191142M1)	30/473-1 (897232M1)
243, 253, 263, 340, 342, 350, 4215, 4220						
Tracteurs français, anglais, américains - Renforcés / French, UK, USA tractors - Heavy duty						
65, 765	30/450-3 (191521M2)	30/451-1 (180010M1)	30/452-1 (353928X1)		30/454-2 (191495M1)	
165, 168, 175 (746276 ⇒), 175S, 178, 185, 188, 253, 263, 265, 275, 275E, 285, 290, 290E, 350, 352, 355, 360, 362, 362N, 365, 372N, 375, 375E, 390, 390E, 390T, 396, 398, 399, 565, 575, 590, 592, 595, 595MKII, 675, 690, 1080, 4215, 4220, 4225, 4235, 4240, 4245, 4255, 4260, 4265, 4270, 4315, 4320, 4325, 4335, 4345, 4355, 4360, 4365, 4370	30/450-4 (898346M93)				30/454-3 (882637M1)	30/473-5 (898350M1)
298, 698, 698T, 699, 2620, 2625, 2640, 2645, 2680, 2685, 2720, 2725, 3050, 3060, 3065, 3070, 3075, 3080, 3085, 3090, 3095, 3115, 3125, 3610, 3630, 3645, 3650, 3655, 6110, 6120, 6130, 6140, 6150 (Moyeu 6 trous / 6 hole hub)		30/451-2 (881384M1)	30/452-2 (882263M1)			

KIT DE RECONDITIONNEMENT DU FILETAGE DES FUSEES DE ROUES AVANT
FRONT SPINDLE THREAD REPAIR KIT



- 70/457-2** Filetage / Thread 3/4" x 16 UNF
- 70/457-8** Filetage / Thread 1 1/4" x 12 UNF

L'écrou intérieur se visse sur le filetage usé et est serré par l'écrou extérieur.
The inner cone nut is screwed on the worn thread and is locked by the outer nut.

Les références des pièces sont indicatives.
Nos pièces ne sont pas d'origine

Part numbers are quoted for reference purposes only.
Our parts and accessories are not original.



"THE RELIABLE SERVICE"



PIÈCES D'AVANT-TRAIN 2 RM
FRONT AXLE PARTS 2 WD

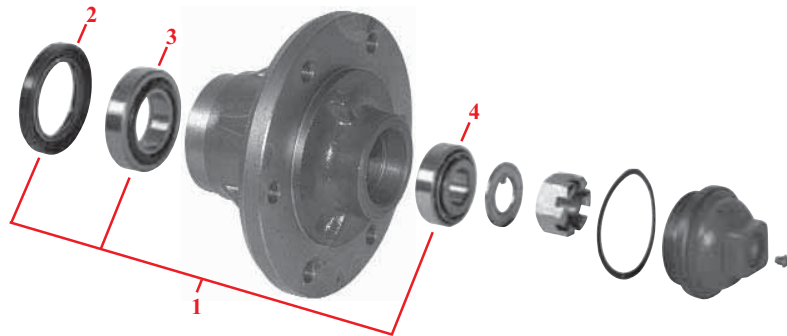

	1	2	3	4
Tracteurs Tractors	Kit réparation Repair kit	Bourrage Oil seal	Roulement int. In. bearing	Roulement ext. Out. bearing
Tracteurs français, anglais, américains - Standards / French, UK, USA tractors - Normal duty				
TEA20, TED20, TEF20, TEH20, 35 (⇒ 368615), 835, 65, 765 (⇒ 601684), 865, 65MKII, 165 (France), 122, 130 (UK)	30/460-1 (1810391M91)	30/461-1 (646110M1)	30/462-1 (1850224M91)	30/463-1 (150662M11)
35 (368616 ⇒), 65, 765 (601685 ⇒), 133, 135, 140, 148 (UK), 135S, 145S, 152S, 158S (⇒ S253018), 145 (⇒ 664499), 165 (UK), 165MKIII (France), 168, 175, 178	30/460-2 (1810416M91)	30/461-2 (897242M1)	30/462-2 (1851800M91)	30/463-2 (895322M91)
25, 122, 130, 133, 135, 140, 148, 152, 155, 158, 825 (France), 135S, 145S, 152S, 158S (S253019 ⇒), 145 (664500 ⇒)	30/460-5 (1639081M91)	30/461-1 (646110M1)	30/463-3 (893373M91)	
230, 235, 240, 243, 245, 250, 253, 255, 260, 263, 265, 275, 340, 342, 350, 550, 560, 565, 4215, 4220	30/460-2 (1810416M91)	30/461-2 (897242M1)	30/462-2 (1851800M91)	
Tracteurs français, anglais, américains - Renforcés / French, UK, USA tractors - Heavy duty				
65, 765	30/460-4 (B1020)	30/461-4 (833355M1)		
165, 168, 175, 175S, 178, 185, 188, 253, 263, 265, 275, 275E, 285, 290, 290E, 298, 350, 352, 355, 360, 362, 362N, 365, 372N, 375, 375E, 390, 390E, 390T, 396, 398, 399, 565, 575, 590, 592, 595, 595MKII, 675, 690, 698, 698T, 699, 1080, 2620, 2625, 2640, 2645, 2680, 2685, 2720, 2725, 3050, 3060, 3065, 3070, 3075, 3080, 3085, 3090, 3095, 3115, 3125, 3610, 3630, 3645, 3650, 3655 (Mogú6 trous / 6 hole hub)	30/460-3 (1810320M91)	30/461-3 (897702M1)	30/462-3 (893375M91)	30/463-3 (893373M91)
3070, 3075, 3080, 3085, 3090, 3095, 3115, 3120, 3125, 3140, 3610, 3630, 3635, 3645, 3650, 3655, 3660, 3670, 3680, 3690 (Mogú8 trous / 8 hole hub)	30/460-38 (B46038)	30/461-51 (3384105M1)	30/462-51 (3000570X91)	30/353-11 (390876X1)
4215, 4220, 4225, 4235, 4240, 4245, 4255, 4260, 4265, 4270, 4315, 4320, 4325, 4335, 4345, 4355, 4360, 4365, 4370, 6110, 6120, 6130, 6140, 6150 (Mogú6 trous / 6 hole hub)	30/460-3 (1810320M91)	30/461-3 (897702M1)	30/462-3 (893375M91)	30/463-3 (893373M91)
6150, 6160, 6170, 6180, 6190, 6235, 6245, 6255, 6260, 6265, 6270, 6280, 6290, 8110, 8120, 8130, 8140, 8150, 8160, 8210, 8220, 8240 (Mogú8 trous / 8 hole hub)	30/460-38 (B46038)	30/461-51 (3384105M1)	30/462-51 (3000570X91)	30/353-11 (390876X1)
Tracteurs italiens / Italian tractors				
134V, 154, 154 F/S/V, 164T F/S/V, 174, 174 F/S/V, 184, 184 F/S, 194, 194 F/S, 233, 234S, 253, 254, 254S, 264T, 264TS, 273, 274, 274 S/SK, 283, 284, 284S, 293, 294, 294S, 333, 334V, 353, 353 LX/S, 363, 363 LX/S, 373, 373 LX/S, 377, 383, 383 LX/S, 387, 393, 393 LX/S/TLX, 397, 397T, 1007, 354, 364, 374, 384, 394, 3210, 3220, 3225, 3235 (tos outèes / all models) 2205, 2210, 2220, 2225, 2230, 2235 (safic niard / 'Non sherpa' models)	30/460-37 (B46037)	30/461-47 (394014X1)	30/462-37 (339394X1)	30/463-37 (339393X1)
1014, 1024, 1114, 1134	30/460-39 (B46039)	30/461-52 (392215X1)	30/352-23 (1442008X1)	30/354-21 (1440637X1)
3315, 3325, 3330, 3340, 3350, 3355 (sans freins avant / without front brakes)	30/460-40 (B46040)	30/461-53 (2.1529.007.0/1)	30/462-53 (2.2530.009.0)	30/463-53 (2.2560.003.0)

Les références des pièces sont indicatives.
Nos pièces ne sont pas d'origine

Part numbers are quoted for reference purposes only.
Our parts and accessories are not original.



"THE RELIABLE SERVICE"



PIÈCES D'AVANT-TRAIN 2 RM
FRONT AXLE PARTS 2 WD

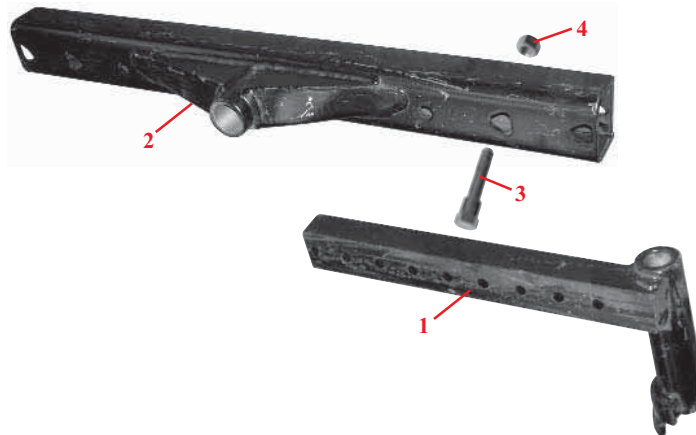

	1	2	3	4	
Tracteurs Tractors	Bras gauche Spindle arm LH	Bras droit Spindle arm RH	Balancier Centre beam	Boulon Bolt	Ecrou Nut
Tracteurs français, anglais, américains / French, UK, USA tractors					
65, 765, 865 (Standart / normal duty)				30/483-1 (182501M1)	30/484-1 (3762112M1)
65, 765 (renforcé / heavy duty)				30/483-2 (894061M1)	30/484-2 (894060M3)
133, 135, 140 (France - largeur normale / France - normal width)			30/482-1 (1865911M95)	30/483-4 (1860268M1)	30/443-1 (353427X1)
135, 148 (GB - renforcé / UK heavy duty), 230, 235, 240, 245, 250, 255, 260 (dégageant standard / standard clearance)	30/468-1 (888304M92)	30/469-1 (888300M92)			
165 (UK), 165MKIII (France), 168, 175, 178 (724937 ⇄), 265, 275, 565 (standart / normal duty)				30/483-1 (182501M1)	30/484-1 (3762112M1)
165, 265, 565 (dégageant standard - renforcé / standard clearance - heavy duty)					
165, 265, 565 (Haute dégageant / high clearance), 168, 275, 175, 178 (724937 ⇄) (renforcé / heavy duty)	30/468-2 (897471M91)		30/482-2 (897625M94)	30/483-2 (894061M1)	30/484-2 (894060M3)
285, 290, 575, 590, 675, 690					

BOULONS 5/8" UNF
5/8" UNF HIGH TENSILE BOLTS

Boulons hexagonaux qualité BS1768 S / 8.8, zincé et passivé.
High tensile hexagon bolts to BS1768 grade S / 8.8, zinc plated and passivated.

Réf. Ref.	OEM	Lg.	Réf. Ref.	OEM	Lg.
70/2070-250	353619X1	2.5" 63m	70/2070-550	353643X1	5.5" 140m
70/2070-300	353623X1	3" 76m	70/2070-700	353655X1	7" 178m
70/2070-350	353627X1	3.5" 89m	70/2070-800	353894X1	8" 203m



Pour commander le boulon complet avec son écrou ajoutez le suffixe A.
To order a bolt complete with full nut add the suffix A.

Les références des pièces sont indicatives.
Nos pièces ne sont pas d'origine

Part numbers are quoted for reference purposes only.
Our parts and accessories are not original.



PIÈCES D'AVANT-TRAIN 2 RM
FRONT AXLE PARTS 2 WD

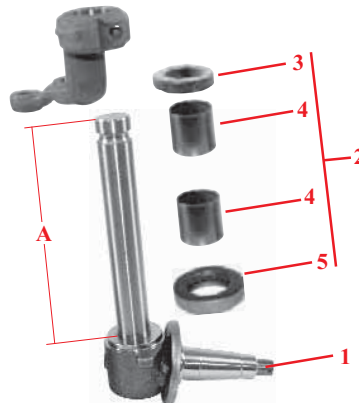

	1	2	3	4	5	
Tracteurs Tractors	Fusée gauche Spindle LH	Fusée droite Spindle RH	Kit réparation Repair kit	Joint Seal	Bague Bush	Roulement Bearing
Tracteurs français, anglais, américains - standards / French, UK, USA tractors - Normal duty						
TEA20, TED20, TEF20, TEH20 35 (⇒ 368615), 835	A ≈80 m 30/470-1 (897415M91)	A ≈80 m 30/471-1 (897414M91)	30/475-1 (B1250)		30/477-1 (180345M1)	
35 (368616 ⇒)	A ≈80 m 30/470-4 (897237M94)	A ≈80 m 30/471-4 (897236M94)				
65, 765 (UK) (dégagement standard - <i>standard clearance</i>)	A ≈95 m 30/470-2 (897570M91)	A ≈95 m 30/471-2 (897569M91)	30/475-2 (1810861M91)	30/476-1 (180355M2)	30/477-2 (196060M1)	30/479-1 (195175M1)
65, 765 (UK) (haut-dégagement - <i>high clearance</i>)	A ≈457 m 30/470-3 (897572M91)	A ≈457 m 30/471-3 (897571M91)				
65, 865 (France)						
65MKII, 165 (France)	A ≈90 m 30/470-45 (969568M91)	A ≈90 m 30/471-45 (969567M91)				
122, 130 (UK)						
133, 135, 140, 148 (UK), 145 (⇒ 664499)	A ≈80 m 30/470-4 (897237M94)	A ≈80 m 30/471-4 (897236M94)	30/475-1 (B1250)		30/477-1 (180345M1)	
133, 135, 140, 148, 152, 155, 158 (France) 135S, 145S, 152S, 158S (S253019 ⇒) 135 (USA - vigneron étroit / USA - vineyard straight axle) 145 (664500 ⇒)	A ≈87 m 30/470-44 (964322M91)	A ≈87 m 30/471-44 (964321M91)	30/475-26 (B47526)		30/477-19 (963533M1)	
165, 168 (UK)	A ≈95 m 30/470-5 (1694234M91)	A ≈95 m 30/471-5 (1694233M91)	30/475-3 (1810862M91)	30/476-2 (183021M2)	30/477-3 (183086M1)	30/479-2 (196167M1)
165MKIII, 168 (France)			30/475-35 (B47535)		30/477-20 (964142M1)	
175, 178	A ≈352 m 30/470-6 (897457M96)	A ≈352 m 30/471-6 (897456M96)	30/475-3 (1810862M91)		30/477-3 (183086M1)	
230, 240 (direction manœ et assistée / Manual & power steering) 235, 245, 250, 255, 260 (dégagement standard / <i>standard clearance</i>)	A ≈80 m 30/470-4 (897237M94)	A ≈80 m 30/471-4 (897236M94)	30/475-1 (B1250)	30/476-1 (180355M2)	30/477-1 (180345M1)	30/479-1 (195175M1)

Les références des pièces sont indicatives.
Nos pièces ne sont pas d'origine

Part numbers are quoted for reference purposes only.
Our parts and accessories are not original.



"THE RELIABLE SERVICE"



PIÈCES D'AVANT-TRAIN 2 RM
FRONT AXLE PARTS 2 WD

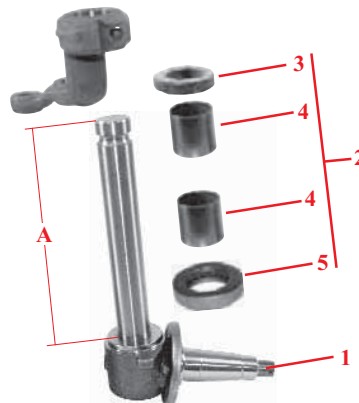

	1	2	3	4	5	
Tracteurs Tractors	Fusée gauche Spindle LH	Fusée droite Spindle RH	Kit réparation Repair kit	Joint Seal	Bague Bush	Roulement Bearing
Tracteurs français, anglais, américains - Standards / French, UK, USA tractors - Normal duty						
230, 240 (direction hydrostatique / hydrostatic steering) 253, 263 (hauteur train : 231 mm / 231mm high axle) 243, 340, 342, 350, 4215, 4220	A ≈ 295 m 30/470-5 (1694234M91)	A ≈ 295 m 30/471-5 (1694233M91)	30/475-27 (B47527)	30/476-2 (183021M2)	30/477-3 (183086M1)	30/479-43 (3599263M1)
265, 275, 550, 565, 560 (dégageant standard / standard clearance)			30/475-3 (1810862M91)			30/479-2 (196167M1)
260, 560 (hauteur dégageant - high clearance)					30/477-51 (3386405M1)	30/479-44 (3618693M1)
3050, 3060, 3065, 3070, 3075, 6110, 6120, 6130, 6140, 6150 (Moyeu 6 trous / 6 hole hub)	A ≈ 300 m 30/470-8 (3384053M11)	A ≈ 300 m 30/471-8 (3384054M11)	30/475-32 (B47532)			
Tracteurs français, anglais, américains - Renforcés / French, UK, USA tractors - Heavy duty						
65, 765 (dégageant standard / standard clearance)	A ≈ 295 m 30/470-7 (880292M91)	A ≈ 295 m 30/471-7 (880291M91)	30/475-3 (1810862M91)	30/476-2 (183021M2)	30/477-3 (183086M1)	30/479-2 (196167M1)
65, 765 (hauteur dégageant - high clearance)						
165, 265, 275 (dégageant standard / standard clearance)	A ≈ 257 m 30/470-9 (898222M96)	A ≈ 257 m 30/471-9 (898221M96)				
165 (⇒ 508596), 265, 275 (dégageant ha- high clearance), 175, 178 (724937 ⇒), 168, 185, 188, 285, 275E, 290, 375E (dégageant standard / standard clearance)	A ≈ 335 m 30/470-10 (897476M96)	A ≈ 335 m 30/471-10 (897475M96)				
165 (508597 ⇒), 175S, 265, 290 (hauteur dégageant - high clearance)	A ≈ 405 m 30/470-24 (3700688M91)	A ≈ 405 m 30/471-24 (3700687M91)				

Les références des pièces sont indicatives.
Nos pièces ne sont pas d'origine

Part numbers are quoted for reference purposes only.
Our parts and accessories are not original.



PIÈCES D'AVANT-TRAIN 2 RM
FRONT AXLE PARTS 2 WD

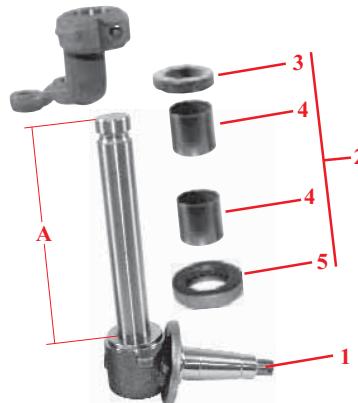

	1	2	3	4	5	
Tracteurs Tractors	Fusée gauche Spindle LH	Fusée droite Spindle RH	Kit réparation Repair kit	Joint Seal	Bague Bush	Roulement Bearing
Tracteurs français, anglais, américains - Renforcés / French, UK, USA tractors - Heavy duty						
290E, 390E (<i>htu dégagement - high clearance</i>)	A ≈335 m 30/470-10 (897476M96)	A ≈335 m 30/471-10 (897475M96)	30/475-27 (B47527)	30/476-2 (183021M2)	30/477-3 (183086M1)	30/479-43 (3599263M1)
275E, 290E, 375E, 390E (<i>htu dégagement - high clearance</i>)	A ≈405 m 30/470-24 (3700688M91)	A ≈405 m 30/471-24 (3700687M91)				
298	A ≈340 m 30/470-40 (1675754M92)	A ≈340 m 30/471-40 (1675753M92)	30/475-28 (B47528)	30/476-16 (1611264M1)	30/477-50 (907485M1)	30/479-44 (3618693M1)
253, 263, 350, 352, 355, 360, 362, 362N, 372N			30/475-27 (B47527)	30/476-2 (183021M2)	30/477-3 (183086M1)	30/479-43 (3599263M1)
365, 375, 390, 390T, 396, 398, 399 (<i>h train :348mm 348mm axle</i>)	A ≈322 m 30/470-25 (3697028M91)	A ≈322 m 30/471-25 (3697027M91)	30/475-29 (B47529)	30/476-15 (882262M1)	30/477-18 (882327M1)	30/479-45 (1696721M1)
565 (<i>dégagement standard / standard clearance</i>)	A ≈257 m 30/470-9 (898222M96)	A ≈257 m 30/471-9 (898221M96)	30/475-3 (1810862M91)	30/476-2 (183021M2)	30/477-3 (183086M1)	30/479-2 (196167M1)
565 (<i>dégagement ht- high clearance</i>)	A ≈335 m 30/470-10 (897476M96)	A ≈335 m 30/471-10 (897475M96)				
575, 590, 675, 690			30/475-30 (B47530)			30/479-44 (3618693M1)

Les références des pièces sont indicatives.
Nos pièces ne sont pas d'origine

Part numbers are quoted for reference purposes only.
Our parts and accessories are not original.



PIÈCES D'AVANT-TRAIN 2 RM
FRONT AXLE PARTS 2 WD

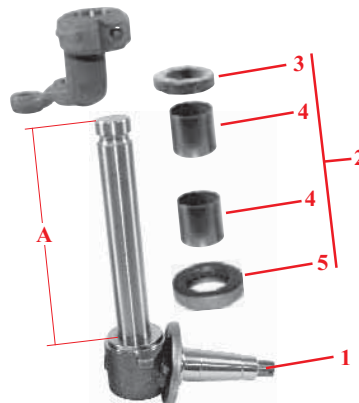

	1	2	3	4	5	
Tracteurs Tractors	Fusée gauche Spindle LH	Fusée droite Spindle RH	Kit réparation Repair kit	Joint Seal	Bague Bush	Roulement Bearing
Tracteurs français, anglais, américains - Renforcés / French, UK, USA tractors - Heavy duty						
592, 595, 595MKII, 1080	A = 402 m 30/470-43 (906186M95)		30/475-31 (B47531)	30/476-2 (183021M2)		
698, 698T, 699, 2625, 2645, 2685, 2725 (U254016 ⇒)	A = 340 m 30/470-40 (1675754M92)	A = 340 m 30/471-40 (1675753M92)	30/475-28 (B47528)	30/476-16 (1611264M1)	30/477-50 (907485M1)	
2620, 2640, 2680, 2720, 2625, 2645, 2685, 2725 (⇒ U254015)						30/479-44 (3618693M1)
3070, 3075, 3080, 3085, 3090, 3095, 3115, 3125, 3610, 3630, 3645, 3650, 3655 (Moyû 6 trous / 6 hole hub)			30/475-32 (B47528)	30/476-2 (183021M2)	30/477-51 (3386405M1)	
3070, 3075, 3080, 3085, 3090, 3095, 3115, 3120, 3125, 3140, 3610, 3630, 3635, 3645, 3650, 3655, 3660, 3670, 3680, 3690 (Moyû 8 trous / 8 hole hub)			(⇒ S028036) 30/475-33 (B47533) (S028037 ⇒) 30/475-34 (B47534)	Sp. / Top 30/476-17 (3715539M1) Inf. / Bottom 30/461-51 (3384105M1)	30/477-52 (3387137M1)	(⇒ S028036) 30/479-46 (3381926M91) (S028037 ⇒) 30/479-47 (3010058X91)
4215, 4220, 4315, 4320			30/475-27 (B47527)	30/476-2 (183021M2)	30/477-3 (183086M1)	30/479-43 (3599263M1)
4225, 4235, 4240, 4245, 4255, 4260, 4265, 4270, 4325, 4335, 4345, 4355, 4360, 4365, 4370			30/475-29 (B47529)	30/476-15 (882262M1)	30/477-18 (882327M1)	30/479-45 (1696721M1)
6150, 6160, 6170, 6180, 6190, 6235, 6245, 6255, 6260, 6265, 6270, 6280, 6290, 8110, 8120, 8130, 8140, 8150, 8160, 8210, 8220, 8240 (Moyû 8 trous / 8 hole hub)			30/475-34 (B47534)	Sp. / Top 30/476-17 (3715539M1) Inf. / Bottom 30/461-51 (3384105M1)	30/477-52 (3387137M1)	30/479-47 (3010058X91)

Les références des pièces sont indicatives.
Nos pièces ne sont pas d'origine

Part numbers are quoted for reference purposes only.
Our parts and accessories are not original.



"THE RELIABLE SERVICE"



PIÈCES D'AVANT-TRAIN 2 RM
FRONT AXLE PARTS 2 WD

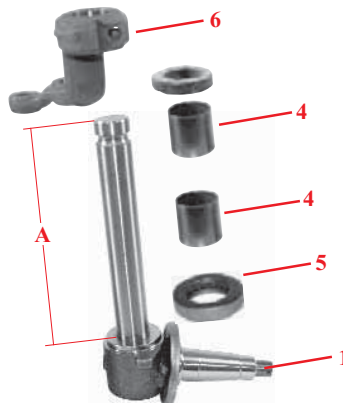

	1		4	5	6	
Tracteurs Tractors	Fusée gauche Spindle LH	Fusée droite Spindle RH	Bague Bush	Roulement Bearing	Levier dir. G Steer. arm LH	Levier dir. D Steer. arm RH
IT Tracteurs italiens / Italian tractors						
134V, 154 F/S/V, 164T F/S/V, 174 F/S/V, 184 F/S, 194 F/S, 334V				30/479-41 (392060X1)		
154 (⇒ 1222477)						
154 (1222478 ⇒), 234S, 254, 264T, 333, 353S, 363S	A ≈252 m 30/470-37 (1424579M94)			30/479-41 (392060X1)	Hidrostat. 30/480-19 (1424974M2)	30/480-20 (1424584M2)
174 (⇒ 1212250), 184 (⇒ 1200825), 194 (⇒ 1230698)						
174 (1212251 ⇒), 184 (1200826 ⇒), 194 (1230699 ⇒), 274, 373S, 383S, 393S	A ≈287 m 30/470-38 (1424578M94)		30/477-39 (975208M1)		Hidrostat. 30/480-19 (1424974M2)	
233, 253, 254S, 263T, 264TS, 353, 353LX, 363, 363LX	A ≈252 m 30/470-37 (1424579M94)			30/479-41 (392060X1)	30/480-19 (1424974M2)	30/480-20 (1424584M2)
273, 274 S/SK, 283, 284, 284S, 293, 294S, 373, 373LX, 377, 383, 383LX, 387, 393, 393 LX/TLX, 397, 397T, 1007	A ≈287 m 30/470-38 (1424578M94)					
354, 364, 374, 384, 394, 3210, 3220, 3225, 3235 (tous modèles / all models), 2205, 2210, 2220, 2225, 2230, 2235 (safichard / 'Non sherpa' models)						
3315, 3325, 3330, 3340, 3350, 3355 (tous modèles / all models)			30/477-53 (2.1559.078.0)	30/479-48 (2.2610.009.0)		

Les références des pièces sont indicatives.
Nos pièces ne sont pas d'origine

Part numbers are quoted for reference purposes only.
Our parts and accessories are not original.



PIÈCES D'AVANT-TRAIN 2 RM
FRONT AXLE PARTS 2 WD

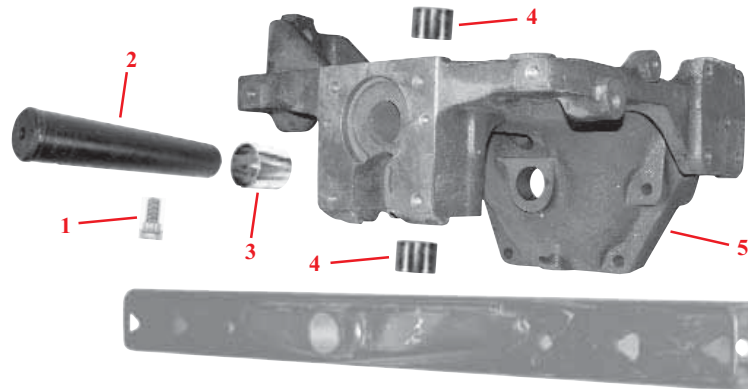

	1	2	3	4	5
Tracteurs Tractors	Boulon d'arrêt Fulcrum bolt	Pivot Front axle pin	Bague pivot Front axle bush	Bague support Support bush	Support Axle support
Tracteurs français, anglais, américains / French, UK, USA tractors					
TEA20, TED20, TEF20, TEH20 (preîr / early)			30/486-1 (180344M1)		
TEA20, TED20, TEF20, TEH20 (dernier / late)			30/486-2 (182850M1)		
35 (⇒ 4859)			30/486-1 (180344M1)		
35 (4860 ⇒), 133, 135, 140, 145 (France) (Preîr - Standard et étroit / Standard & narrow - Early) 135 (UK ⇒ 140128), 835	30/481-1 (181953M2)	30/485-1 (183221M1)	30/486-2 (182850M1)		
65, 765, 865, 165 (France - Preîr / France - Early)			Avant / Front 30/486-4 (196049M1) Arrière / Rear 30/486-40 (196050M2)	30/487-4 (196057M1)	
133, 135, 140 (Vigneron / Vineyard ⇒ E205116)		30/485-28 (964310M4)			
133, 135, 140, 145 (France) (Dernier - Standard et étroit / Standard & narrow - Late) 135 (USA - Vigneron étroit / USA - Vineyard straight axle) 152 (Standard et étroit / Standard & narrow ⇒ C292014)		30/485-15 (909911M1)			
135 (UK ⇒ 434523) 148 (UK ⇒ 604669)	30/481-2 (1862267M1)	30/485-2 (1869634M1)			30/488-4 (1688611M91)
133, 135, 140, 145, 148 (MKIII France) (Preîr - Standard et étroit / Standard & narrow - Early) 135 (UK 434524 ⇒), 148 (UK 604670 ⇒), 152 (Standard et étroit / Standard & narrow C292015 ⇒) 152MKIII (Preîr / Early)	30/481-3 (1867906M1)	30/485-3 (1869633M1)	30/486-3 (1660114M2)		
133, 135, 145, 148, 152 (MKIII France - Dernier / Late)		30/485-5 (3381384M2)			
155, 158 (Standard et étroit / Standard & narrow ⇒ C292014)		30/485-15 (909911M1)			
155, 158 (Standard et étroit / Standard & narrow C292015 ⇒) 155, 158 (MKIII - Preîr / Early)	30/481-3 (1867906M1)	30/485-3 (1869633M1)			
155, 158 (MKIII - Dernier / Late)		30/485-5 (3381384M2)			

Les références des pièces sont indicatives.
Nos pièces ne sont pas d'origine

Part numbers are quoted for reference purposes only.
Our parts and accessories are not original.



PIÈCES D'AVANT-TRAIN 2 RM
FRONT AXLE PARTS 2 WD

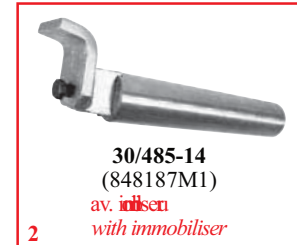
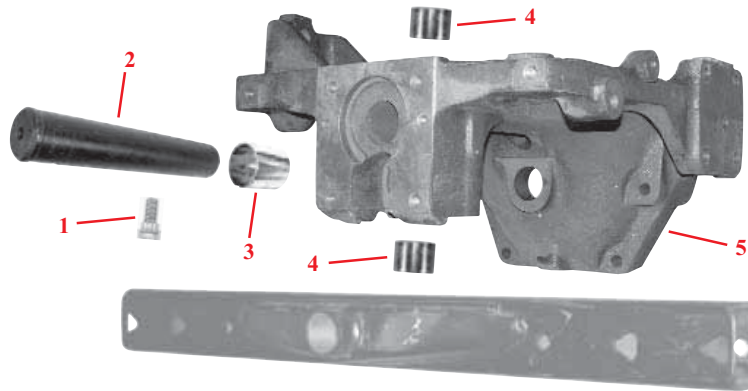

	1	2	3	4	5
Tracteurs Tractors	Boulon d'arrêt Fulcrum bolt	Pivot Front axle pin	Bague pivot Front axle bush	Bague support Support bush	Support Axle support
Tracteurs français, anglais, américains / French, UK, USA tractors					
175, 178 (⇒ 724936)			Avant / Front 30/486-4 (196049M1)	30/487-4 (196057M1)	
165 (UK), 165MKIII (France), 168, 175, 178 (724937 ⇒) 185, 188	30/481-2 (1862267M1)	30/485-4 (898016M3) av. nilsen with immobiliser 30/485-14 (848187M1)	30/486-5 (897712M2)	30/487-1 (897235M1)	30/488-2 (1870287M95)
235, 245, 255 (⇒ Z173012) 260 (dégageant standard / standard clearance)	30/481-3 (1867906M1)	30/485-3 (1869633M1)	30/486-3 (1660114M2)		30/488-4 (1688611M91)
230, 240 (direction manuel / manual steering ⇒ P33138) 230, 240 (direction assistée / power steering), 235, 245, 255 (Z173013 ⇒), 250		30/485-5 (3381384M2)			
230, 240 (direction manuel / manual steering P33139 ⇒)		30/485-45 (3599738M1)			
230, 240 (direction hydrostatique / hydrostatic steering ⇒ P33138)		30/485-40 (3595741M92)	Avant / Front 30/486-62 (1693924M1)		
230 (P33139 ⇒), 240 (P33139 ⇒ A20286) (direction hydrostatique / hydrostatic steering)		30/485-41 (3599705M91)	Arrière / Rear 30/486-6 (1660457M2)		
240 (A20287 ⇒), 243, 263, 253 (P33139 ⇒) (direction hydrostatique / hydrostatic steering)			30/486-6 (1660457M2)		
253 (⇒ P33138)		30/485-40 (3595741M92)			
265 (⇒ 193551), 275 (⇒ 221521), 285, 290 (Preinr / Early)	30/481-2 (1862267M1)	30/485-4 (898016M3) av. nilsen with immobiliser 30/485-14 (848187M1)	30/486-5 (897712M2)	30/487-1 (897235M1)	30/488-2 (1870287M95)
265 (193552 ⇒), 275 (221522 ⇒), 275E, 290 (Dernier / Late), 290E, 375E, 390E		30/485-46 (1684285M1)			
298 (France)	30/481-2 (1862267M1)	30/485-4 (898016M3) av. nilsen with immobiliser 30/485-14 (848187M1)	30/486-63 (1675908M2)		

Les références des pièces sont indicatives.
Nos pièces ne sont pas d'origine

Part numbers are quoted for reference purposes only.
Our parts and accessories are not original.



"THE RELIABLE SERVICE"



PIÈCES D'AVANT-TRAIN 2 RM
FRONT AXLE PARTS 2 WD

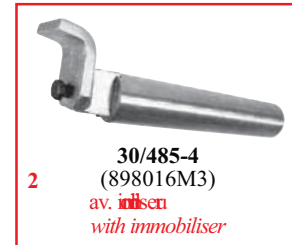
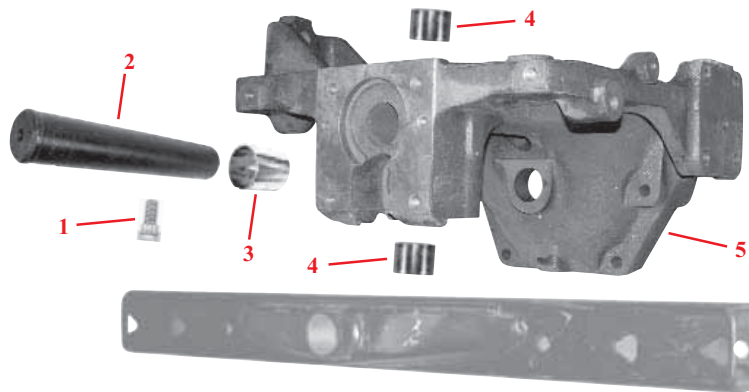

	1	2	3	4	5
Tracteurs Tractors	Boulon d'arrêt Fulcrum bolt	Pivot Front axle pin	Bague pivot Front axle bush	Bague support Support bush	Support Axle support
Tracteurs français, anglais, américains / French, UK, USA tractors					
298 (UK)			30/486-63 (1675908M2)		
340, 350, 355, 360 (⇒ P33138)		30/485-40 (3595741M92)	<i>Avant / Front</i> 30/486-6 (1660457M2)		
340, 350, 355, 360 (P33139 ⇒) 342, 352, 362, 362N, 372N		30/485-41 (3599705M91)	<i>Arrière / Rear</i> 30/486-62 (1693924M1)		
365, 375, 390, 390T, 396, 398, 399 (⇒ 13/11/94)		30/485-42 (1695081M1)	30/486-63 (1675908M2)		
365, 375, 390, 390T, 396, 398, 399 (14/11/94 ⇒)		30/485-43 (3700469M2)			
550			30/486-3 (1660114M2)		
565, 575, 590 675, 690 (⇒ K123002)	30/481-2 (1862267M1)	30/485-4 (898016M3) av. inlisen with immobiliser 30/485-14 (848187M1)	30/486-5 (897712M2)	30/487-1 (897235M1)	30/488-2 (1870287M95)
675, 690 (K123003 ⇒)		30/485-46 (1684285M1)			
698 (⇒ 12/82)	30/481-2 (1862267M1)	30/485-4 (898016M3) av. inlisen with immobiliser 30/485-14 (848187M1)	30/486-63 (1675908M2)		
698 (01/83 ⇒), 698T, 699		30/485-46 (1684285M1)			
4215, 4220, 4315, 4320		30/485-44 (3813360M1)	30/486-6 (1660457M2)		
4225, 4235, 4240, 4245, 4325, 4335, 4345 (Marchepied / Footstep)		30/485-43 (3700469M2)	30/486-63 (1675908M2)		

Les références des pièces sont indicatives.
Nos pièces ne sont pas d'origine

Part numbers are quoted for reference purposes only.
Our parts and accessories are not original.



PIÈCES D'AVANT-TRAIN 2 RM
FRONT AXLE PARTS 2 WD

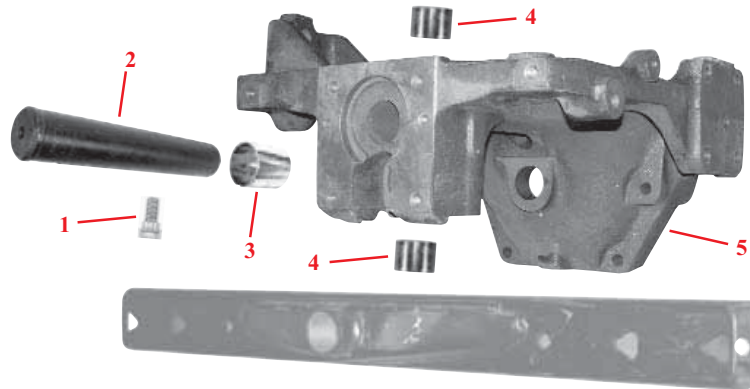

	1	2	3	4	5
Tracteurs Tractors	Boulon d'arrêt Fulcrum bolt	Pivot Front axle pin	Bague pivot Front axle bush	Bague support Support bush	Support Axle support
IT Tracteurs italiens / Italian tractors					
134V, 154V, 164TV, 174V, 334V, 354V/VQ864V/VQ 374V/VQ884V/VQ					
154, 154 F/S, 164T F/S, 174, 174 F/S, 184, 184 F/S, 194, 194 F/S, 233, 234S, 253, 254, 254S, 264T, 264TS, 273, 274, 274 S/SK, 283, 284, 284S, 293, 294, 294S, 333, 353, 353 LX/S, 363, 363 LX/S, 373, 373 LX/S, 377, 383, 383 LX/S, 387, 393, 393 LX/S/TLX, 397, 397T, 1007 354, 364, 374, 384, 394 (tous modèles safi V/VQ <i>All models except V/VQ</i>), 2205, 2210, 2220, 2225, 2230, 2235 (safi cbnirrd / <i>'Non Sherpa' models</i>), 3210, 3220, 3225, 3235 (tous modèles / <i>all models</i>)		30/485-30 (1423630M2)	30/486-65 (1423636M1)		

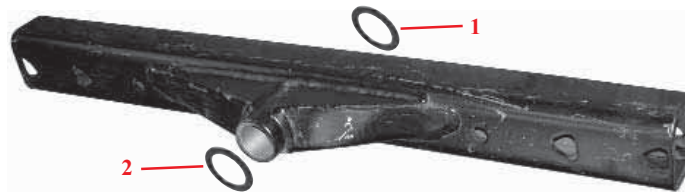

	1	2		
Tracteurs Tractors	Rondelle Thrust washer	Cale Shim		
Tracteurs français, anglais, américains / French, UK, USA tractors				
165, 168, 185, 188, 175, 178 (724937 ⇨)				
230, 240, 243, 253, 263 (direction hydrostatique / <i>hydrostatic steering</i>)				
265, 275, 275E, 285, 290, 290E				
340, 342, 350, 352, 355, 360, 362, 362N, 365, 372N, 375, 375E, 390, 390E, 390T, 396, 398, 399	30/489-1 (898017M1)	30/489-2 (898018M1) 0.71 m 0.028 "	30/489-3 (898019M1) 0.87 m 0.034 "	30/489-4 (898020M1) 0.99 m 0.039 "
565, 575, 590, 675, 690, 698, 698T, 699				
4215, 4220, 4315, 4320				
4225, 4235, 4240, 4245, 4325, 4335, 4345 (archepied / <i>Footstep</i>)				

Les références des pièces sont indicatives.
Nos pièces ne sont pas d'origine

Part numbers are quoted for reference purposes only.
Our parts and accessories are not original.



PIÈCES D'AVANT-TRAIN 2 RM - TRACTEURS INDUSTRIELS
FRONT AXLE PARTS 2 WD - INDUSTRIAL TRACTORS

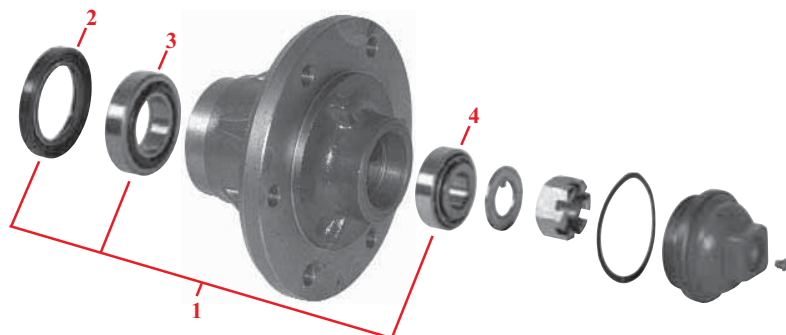

	1	2	3	4
Tracteurs Tractors	Kit réparation Repair kit	Bouillage Oil seal	Roulement int. In. bearing	Roulement ext. Out. bearing
20B, 20D, 20E	30/460-2 (1810416M91)	30/461-2 (897242M1)	30/462-2 (1851800M91)	30/463-2 (895322M91)
20F, 30D, 30E, 30H, 40, 40E	30/460-3 (1810320M91)	30/461-3 (897702M1)	30/462-3 (893375M91)	30/463-3 (893373M91)
50, 50B, 50B MK11, 50D, 50E, 50EX, 50H, 50HX, 50HX-S, 50HX-T, 60H, 60H-S, 60HX, 60HX-T	30/460-24 (3405259M92)	30/461-24 (882261M1)	30/462-24 (882554M91)	30/463-24 (645695M91)

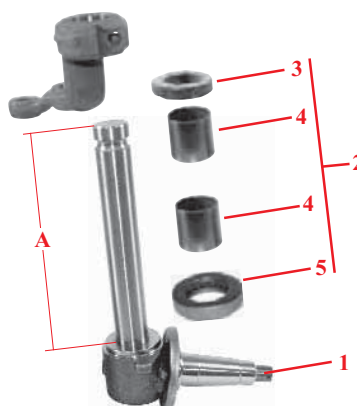

	1	2	3	4	5	
Tracteurs Tractors	Fusée gauche Spindle LH	Fusée droite Spindle RH	Kit réparation Repair kit	Joint Seal	Bague Bush	Roulement Bearing
20B	A ≈280 m 30/470-4 (897237M94)	A ≈280 m 30/471-4 (897236M94)	30/475-1 (B1250)	30/476-1 (180355M2)	30/477-1 (180345M1)	30/479-1 (195175M1)
20D, 20E	A ≈295 m 30/470-5 (1694234M91)	A ≈295 m 30/471-5 (1694233M91)				
20F			30/475-3 (1810862M91)	30/476-2 (183021M2)	30/477-3 (183086M1)	30/479-2 (196167M1)
30D	A ≈257 m 30/470-9 (898222M96)	A ≈257 m 30/471-9 (898221M96)				
30E, 30H, 40, 40E						
50, 50B, 50 MK11, 50D, 50H, 50HX, 60H	A ≈233 m 30/470-23 (882257M92)	A ≈233 m 30/471-23 (882256M92)	30/475-23 (B1272)	30/476-15 (882262M1)	30/477-18 (882327M1)	30/479-18 (832961M1)
50E, 50EX						

Les références des pièces sont indicatives.
Nos pièces ne sont pas d'origine

Part numbers are quoted for reference purposes only.
Our parts and accessories are not original.



ROTULES & TIRANTS DE DIRECTION
TIE RODS & SOCKETS

La section rotules et tirants de direction est présentée de façon à donner les applications, la position sur le tracteur ainsi qu'une illustration et les dimensions. Ci-dessous, veuillez trouver un exemple de comment utiliser cette section.

The Tie Rod section has been designed to provide the application, the positioning on the tractor, together with an illustration including measurement detail. See example below.

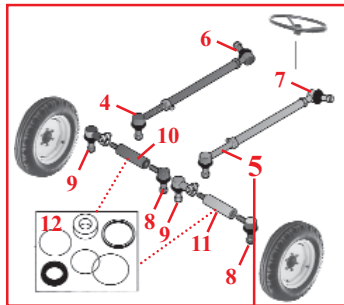

Position de la rotule :
Voir le schéma haute à page

*The tie rod or socket position :
See figures at the top of the page*

D

D3 (90°)
D4 (135°)
D2 (45°)
D5 (180°)
D1 (0°)
D6 (225°)
D7 (270°)

Angl / Angle

Réf Ref.	Angle Angle	Ø	Longueur Length	Conicité Cone
30/491-3	D2	19/32"	7	9/16"- 5/8"
30/491-2	D4		7	
30/491-19	D6	6	204m	11/16"- 3/4"
30/491-20	D4	6		

Photo et mesures de la rotule :
Voir le cadre en tête de section

*Tie rod or socket picture and size :
See the diagram at the beginning of the section*

5 D4

30/491-2
(1860408M2)

Pos.	Fig.	4	D2	5	D4	6-7	B								
135, 148, 230, 240, 250 (Manuèl / Manual) (Englnd)		30/491-3 (1860412M2)		30/491-2 (1860408M2)											
				30/492-1 (826752M92)											
135, 148, 230, 240, 250 (Assisté / Power steering) (Englnd)		30/491-20 (1692144M1)		30/491-19 (1860564M2)		30/581-1 (1851617M2)		30/581-2 (1851618M2)		30/580-1 (3401241M91)		30/580-2 (3401241M91)			
										30/585-1 (3314663M91)					
		21	B	23	B	24	B	25	B	32	B	33	B		
154, 174, 184, 194		30/495-84 (1821234M91)		30/495-84 (1821234M91)		30/495-84 (1821234M91)		30/495-84 (1821234M91)		30/495-84 (1821234M91)		30/495-84 (1821234M91)			
		13	B	14	G	15	D5	16	K	17	C	18	G	19	D1

Les références des pièces sont indicatives.
Nos pièces ne sont pas d'origine

*Part numbers are quoted for reference purposes only.
Our parts and accessories are not original.*



**ROTULES & TIRANTS DE DIRECTION (2RM)
TIE RODS & SOCKETS (2WD)**

A



Réf Ref.	Filetage Thread	Longueur Length	Conicité Cone
30/491-12	M3/8"BSP	80m	9/16"- 21/32"
30/581-1	M1/2X20D	40m	9/16"- 5/8"
30/491-1	M11/16X18D	80m	
30/497-26	M1X16D	95m	3/4"- 7/8"
30/495-36	M24x1.5G	75m	20-22
30/495-34	M24x1.5D	100m	18-20
30/495-33	M28x1.5D	105m	20-22
30/495-35			24-26

B



Réf Ref.	Filetage Thread	Longueur Length	Conicité Cone
30/492-12	M3/8"BSP	80m	11/16"- 3/4"
30/492-1	M11/16X18G		
30/492-2	M13/16X16D	100m	
30/498-5			

C



Réf Ref.	Filetage Thread	Longueur Length	Conicité Cone
30/498-1	M 13/16X16D	150/40m	M20-22 F11/16"- 3/4"
30/498-2		165/55m	
30/498-3	M1X16D		

M18D :Roté filetage mâle M18 droit /
F24G :Roté filetage femelle M24 gauche /

Tie rod male M18 RH Thread
Tie rod female M24 LH Thread

D

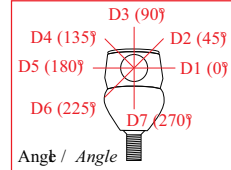

Réf Ref.	Angle Angle	Ø	Longueur Length	Conicité Cone	
30/491-3	D2	19/32"	7	200m	
30/491-2	D4		7		9/16"- 5/8"
30/491-19	D6		6	11/16"- 3/4"	
30/491-30	D3	5/8"	7	164m	
30/491-32			7	165m	11/16"- 3/4"
30/491-29	D2		7	170m	
30/495-7	D5	3/4"	10	320m	
30/495-6	D1		10		
30/495-1	D1	3/4"	6	365m	
30/495-2	D5		6		
30/495-8	D7		7		370m
			7		

E



Réf Ref.	Ø	Longueur Length	Conicité Cone
30/495-71	15/16"	6	390m
30/495-167	15/16"	7	735m

F



Réf Ref.	Ø	Longueur Length	Conicité Cone
30/581-26	28	7	410m

Les références des pièces sont indicatives.
Nos pièces ne sont pas d'origine

Part numbers are quoted for reference purposes only.
Our parts and accessories are not original.



**ROTULES & TIRANTS DE DIRECTION (2RM)
TIE RODS & SOCKETS (2WD)**

G



Réf Ref.	Ø int. Inner Ø	Longueur Length	Conicité Cone
30/497-1	3/4"	380m	11/16"- 3/4"
30/497-3		385m	
30/497-5		1270m	
30/491-31	13/16"	1270m	

L



Réf Ref.	Filetage Thread	Longueur Length	Conicité Cone
30/581-2	F1/2X20D UNF	35m	9/16"- 5/8"

H



Réf Ref.	Ø int. Inner Ø	Longueur Length	Conicité Cone
30/498-4	3/4"	470/510m	11/16"- 3/4"
30/492-25	5/8"	980/1010m	11/16"- 3/4"

M



Réf Ref.	Filetage Thread	Longueur Length	Conicité Cone
30/495-50	F28x1.5D	105m	24-26

J



Réf Ref.	Ø int. Inner Ø	Filetage Thread	Longueur Length
30/497-29	15/16"	F1X16D	400m

P



Réf Ref.	Ø ext. Outer Ø	Longueur Length	Conicité Cone
30/490-3	3/4"	1105m	11/16"- 3/4" 11/16"- 3/4"
30/490-5	3/4"	1180m	11/16"- 3/4" 11/16"- 3/4"

K



Réf Ref.	Ø int. Inner Ø	Filetage Thread	Longueur Length
30/497-30	3/4"	F13/16X16D	470m
30/492-27	5/8"	F11/16X18G	940m

Q



Réf Ref.	Ø int. Inner Ø	Filetage Thread	Longueur Length	Conicité Cone
30/495-32	15.28m	M1/2X28D	215m	18-20

M18D :Roth filetage M18 droit / Tie rod male M18 RH Thread
F24G :Roth filetage femelle M24 gauche / Tie rod female M24 LH Thread

Les références des pièces sont indicatives.
Nos pièces ne sont pas d'origine

Part numbers are quoted for reference purposes only.
Our parts and accessories are not original.



ROTULES & TIRANTS DE DIRECTION (2RM)
TIE RODS & SOCKETS (2WD)

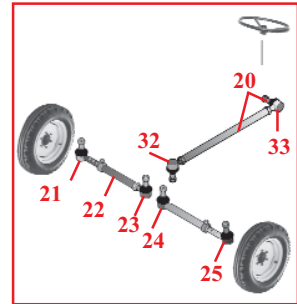
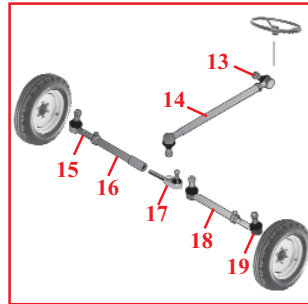
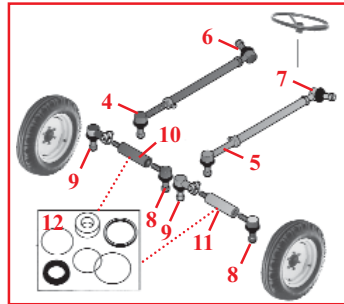
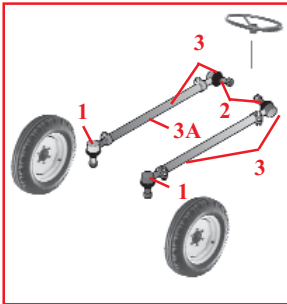

Pos.	Fig.	1	A	2	B										
TE20		30/491-12 (126920)		30/492-12 (893607M91)											
FE35, 35, 35X, 135		30/491-1 (1862029M91)													
		30/491-29 (1808432M1)													
133, 135, 140, 145, 152, 155, 158, 230, 235, 240, 245, 250, 255, 260 (France)		1 D3 30/491-30 (1808893M1)		30/492-1 (826752M92)		30/492-25 (1808435M91)		30/492-27 (964341M94)							
		1 D3 30/491-32 (1670417M1) (260 selu only)													
		4 D2		5 D4		6-7 B									
135, 148, 230, 240, 250 (Manab / Manual) (UK)		30/491-3 (1860412M2)		30/491-2 (1860408M2)											
		4 D2		5 D4		30/492-1 (826752M92)									
135, 148, 230, 235, 240, 245, 250, 255 (Assistée / Power steering) (UK)		30/491-19 (1692144M1)		30/491-19 (1692144M2)			30/581-1 (1851617M2)	30/581-2 (1851618M2)		30/580-2 (3401241M91)	30/580-1 (3401240M91)				
										12	Jeurépar. / Rep kit				
										30/585-1 (3314663M91)					
		21 B		23 B		24 B	25 B	32 B		33 B					
154, 174, 184, 194		30/492-2 (1821234M91)		30/492-2 (1821234M91)		30/492-2 (1821234M91)	30/492-2 (1821234M91)	30/492-2 (1821234M91)		30/492-2 (1821234M91)					
		13 B		14 G		15 D5	16 K	17 C		18 G		19 D1			
65, 765 (⇒ 526080) Norai						30/495-2 (881883M91)		30/498-1 (182519M91)		30/497-1 (186061M91)		30/495-1 (880008M92)			
						15 D5		30/497-30 (186065V91)		17 C		19 D1			
65, 765 (526081 ⇒) Renforcé / Heavy duty						30/495-7 (880010M92)				30/498-2 (894654M91)		30/495-6 (880011M92)			
		30/492-2 (1821234M91)		30/491-31 (828234M91)		15 D5				17 C		18 G	19 D1		
175, 178 Norai						30/495-2 (881883M91)						30/497-3 (880012M93)	30/495-1 (880008M92)		
						15 D5						18 G	19 D1		
175, 178 (⇒ 724936) Renforcé / Heavy duty						30/495-7 (880010M92)						30/497-1 (1886557M91)	30/495-6 (880011M92)		
		20 P		21 D7		22+23 H	23 B	24 G		25 D7					
175, 178 (724937 ⇒) 188		30/490-5 (885549M91)													
		20 P		30/495-8 (881736M92)		30/498-4 (1810366M91)	30/498-5 (886802M91)	30/497-5 (886797M91)		30/495-8 (881736M92)					
165, 168, 185, 265, 275, 285, 290		30/490-3 (884797M91)													

Les références des pièces sont indicatives.
Nos pièces ne sont pas d'origine

Part numbers are quoted for reference purposes only.
Our parts and accessories are not original.



"THE RELIABLE SERVICE"



**ROTULES & TIRANTS DE DIRECTION (2RM)
TIE RODS & SOCKETS (2WD)**

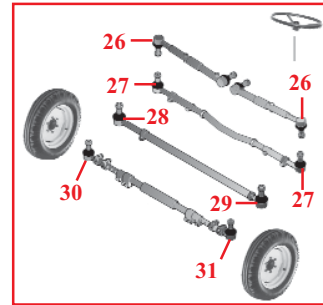
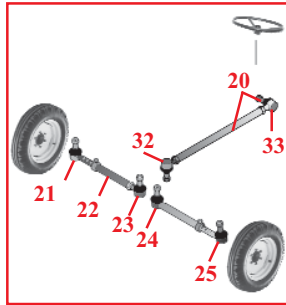
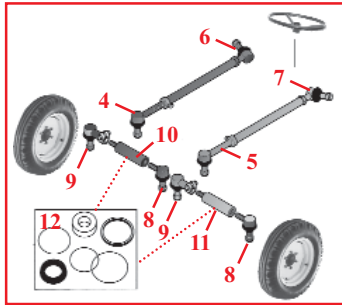

Pos.	Fig.	26	F	27	E																
298		30/495-177 (1678024M1)		30/495-178 (1678023M1)																	
		Pos.	Fig.	28		29		A													
230, 240, 253, 340, 342, 350, 352, 355, 360, 362, 362N, 372N (England)		30/495-58 (3901824M91)		30/495-33 (3901825M91)																	
		Pos.	Fig.	30		Q															
230, 240, 253, 340, 342, 350, 352, 355, 360, 362, 362N, 372N (England) <i>Hydrostatic / Hydrostatic</i>		30/495-32 (3443036M91)																			
		Pos.	Fig.	21		B	23		B	24		B	25		B						
253, 254, 263, 264, 273, 274, 283, 284, 293, 294, 364, 374, 384, 394		30/492-2 (1821234M91)		30/492-2 (1821234M91)		30/492-2 (1821234M91)		30/492-2 (1821234M91)													
		Pos.	Fig.	30		M	31		A												
365, 375, 390, 390T, 398, 399 <i>Hydrostatic / Hydrostatic</i> (⇒ B18008, ⇒ P33138)		30/495-50 (3599679M92)		30/495-35 (3595527M91)																	
				31		M															
Idem (B18009 ⇒, P33139 ⇒)				30/495-50 (3599679M92)																	
		Pos.	Fig.				8		A	9		L	10		D/RH	11		G/LH			
550, 560										30/581-1 (1851617M2)		30/581-2 (1851618M2)	30/580-1 (3401240M91)		30/580-2 (3401241M91)						
													12		Jourépar. / Rep kit						
													30/585-1 (3314663M91)								
		Pos.	Fig.				21		D7	22+23		H	23		B	24		G	25		D7
565, 575, 590, 675, 690							30/495-8 (881736M92)		30/498-4 (1810366M91)	30/498-5 (886802M91)		30/497-5 (886797M91)	30/495-8 (881736M92)								
		Pos.	Fig.	21		E	22		J	23		A									
592, 595, 1080, 1085		30/495-71 (1807258M1)		30/497-29 (1807260M1)		30/497-26 (3033244M2)															
		Pos.	Fig.	26		F	27		E												
698, 698T, 699		30/495-177 (1678024M1)		30/495-178 (1678023M1)																	
		Pos.	Fig.	21		B	23		B	24		B	25		B						
1007, 1114		30/492-2 (1821234M91)		30/492-2 (1821234M91)		30/492-2 (1821234M91)		30/492-2 (1821234M91)													
		Pos.	Fig.	21		A	23		A	24		A	25		A						
1014, 1134		30/495-34 (3426773M3)		30/495-34 (3426773M3)		30/495-34 (3426773M3)		30/495-34 (3426773M3)													

Les références des pièces sont indicatives.
Nos pièces ne sont pas d'origine



"THE RELIABLE SERVICE"



Part numbers are quoted for reference purposes only.
Our parts and accessories are not original.

ROTULES & TIRANTS DE DIRECTION (2RM)
TIE RODS & SOCKETS (2WD)

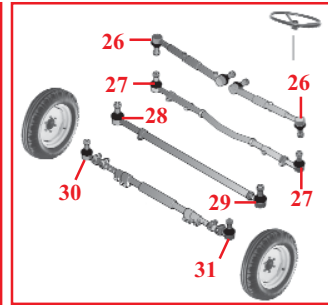
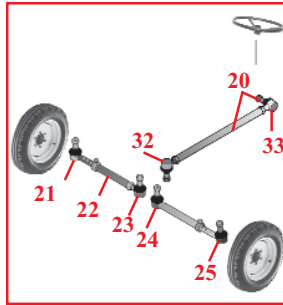
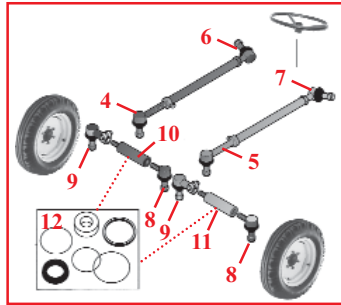
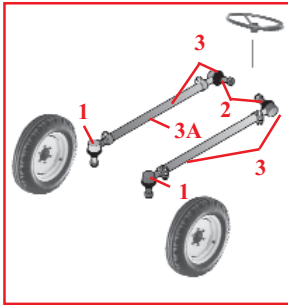

Pos.	Fig.	30	B	31	B				
2205, 2210, 2220, 2230		30/492-2 (1821234M91)		30/492-2 (1821234M91)					
Pos.	Fig.	26	F	28	A	29	E		
2620, 2625, 2640, 2645, 2680, 2685, 2720, 2725		30/581-26 (3381924M3)		30/497-26 (3033244M2)		30/495-167 (3033243M3)			
Pos.	Fig.	30	A	31	A				
3050, 3060, 3065, 3070, 3080, 3085, 3090, 3095, 3115, 3120, 3125, 3140, 3610, 3630, 3635, 3645, 3650, 3655, 3660, 3670, 3680, 3690		30/495-36 (3104945M1)		30/495-36 (3104945M1)					
Pos.	Fig.	28		29	A				
4215, 4220, 4315, 4320		30/495-58 (3901824M91)		30/495-33 (3901825M91)					
Pos.	Fig.	28	Q						
4215, 4220, 4315, 4320 <i>Hydrostatic / Hydrostatic</i>		30/495-32 (3443036M91)							
Pos.	Fig.	30	M	31	M				
4225, 4235, 4240, 4245, 4255, 4260, 4265, 4270, 4325, 4335, 4345, 4360, 4365, 4370		30/495-50 (3599679M92)		30/495-50 (3599679M92)					
Pos.	Fig.	30	A	31	A				
6110, 6120, 6130, 6140, 6150, 6160, 6170, 6180, 6190, 6235, 6245, 6255, 6260, 6265, 6270, 6280, 6290, 8110, 8120, 8130, 8140, 8150, 8160, 8210, 8220, 8240		30/495-36 (3104945M1)		30/495-36 (3104945M1)					
Tracteurs industriels / Industrial tractors									
Pos.	Fig.	4	D2	5	D4	6-7	B		
20D		30/491-3 (1860412M2)		30/491-2 (1860408M2)		30/492-1 (826752M92)			
Pos.	Fig.	20	P	21+25	D7	23	B		
30D, 30E		30/490-3 (884797M91)		30/495-8 (881736M92)		30/498-5 (886802M91)			
Pos.	Fig.	6-7	B						
40		30/492-2 (1821234M91)							
Pos.	Fig.	20	P	24	G	23	B	6-7	B
50, 50B, 50BMKIII		30/490-3 (884797M91)		30/497-5 (886797M91)		30/498-5 (886802M91)		30/492-2 (1821234M91)	
Pos.	Fig.	23	B						
50D		30/498-5 (886802M91)							

Les références des pièces sont indicatives.
Nos pièces ne sont pas d'origine

Part numbers are quoted for reference purposes only.
Our parts and accessories are not original.



**ROTULES & TIRANTS DE DIRECTION (4RM)
TIE RODS & SOCKETS (4WD)**

A



Réf Ref.	Filetage Thread	Longueur Length	Conicité Cone
30/495-34	M24x1.5D	100m	18-20
30/495-40	M24x1.5G		
30/495-35	M24x1.5D	105m	20-22

N



Réf Ref.	Filetage Thread	Longueur Length	Conicité Cone
30/495-37	F18x1.5D	200m	20-22
30/495-38		250m	
30/495-41	F24x1.5D	265m	23.5-26
30/495-61	F18x1.5D	220m	
30/495-62		285m	
30/495-63	F24x1.5D	258m	27-30
30/495-64		240m	23.5-26
30/495-65		195m	27-30
30/495-66	F18x1.5D	180m	20-22
30/495-120		270m	
30/495-121	F24x1.5D	190m	23.5-26
30/495-246		295m	
30/495-247			

B



Réf Ref.	Filetage Thread	Longueur Length	Conicité Cone
30/492-2	M13/16x16D	100m	11/16" 3/4"

L



Réf Ref.	Filetage Thread	Longueur Length	Conicité Cone
30/497-20	F22x1.5D	80m	23.5-26

S



Réf Ref.	Filetage Thread	Longueur Length	Conicité Cone
30/497-16	M18x1.5D/M20x1.5D	180m	
30/497-17	M24x1.5D/M22x1.5D	210m	
30/497-105	M18x1.5D/M18x1.5D	180m	
30/497-191	M24x1.5D/M22x1.5D	210m	

M



Réf Ref.	Filetage Thread	Longueur Length	Conicité Cone
30/497-18	F18x1.5D	70m	3/4" 7/8"
30/497-19			
30/497-27	F11/16x18D	68m	18-20

M18D :Roth filetage à M18 droit / Tie rod male M18 RH Thread
F24G :Roth filetage femelle M24 gauche / Tie rod female M24 LH Thread

Les références des pièces sont indicatives.
Nos pièces ne sont pas d'origine

Part numbers are quoted for reference purposes only.
Our parts and accessories are not original.



ROTULES & TIRANTS DE DIRECTION (4RM)
TIE RODS & SOCKETS (4WD)

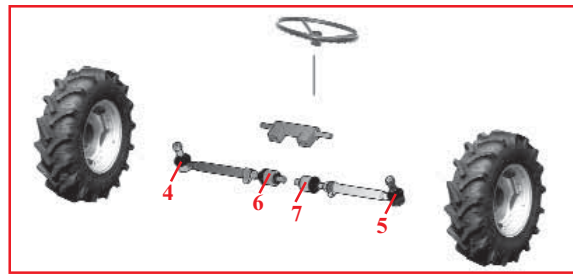
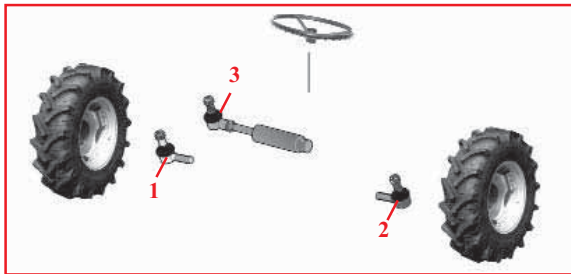

Pos.	Fig.	1	B	2	B	3	M	
154, 253, 254, 263, 273, 274, 283, 284, 293, 294						30/497-18 (1617826M94)		
Pos.	Fig.					3	M	
174 (⇒ 221454), 184 (⇒ 2200556), 194 (⇒ 2230478)		30/492-2 (1821234M91)		30/492-2 (1821234M91)		30/497-27 (1809676M91)		
Pos.	Fig.					3	M	
174 (221455 ⇒), 184 (2200557 ⇒), 194 (2230479 ⇒)						30/497-18 (1617826M94)		
Pos.	Fig.	1	A	2	A			
165, 168, 185, 188, 275, 285, 298, 350, 360, 365, 375, 390, 398, 399, 575, 590, 592, 698, 698T, 699, 1004, 1104, 1134 <i>Catégorie / Category 3</i>		30/495-34 (3426773M3)		30/495-34 (3426773M3)				
Pos.	Fig.	1	B	2	B			
250, 265, 275, 285, 290, 575, 590, 592, 675, 690 <i>Catégories / Category 1 &</i>		30/492-2 (1821234M91)		30/492-2 (1821234M91)				
Pos.	Fig.					3	M	
250, 265, 275, 290, 298, 575, 590, 675, 690, 698, 698T, 699, 1004 <i>Catégories / Category 1, 2 &</i>						30/497-18 (1617826M94)		
Pos.	Fig.	4	N	5	N	6	S	7
240 (A20287 ⇒) 253, 263, 342, 352, 362N, 372N, 382N		30/495-120 (3429173M3)		30/495-120 (3429173M3)		30/497-105 (3428268M1)		30/497-105 (3428268M1)
Pos.	Fig.	4	N	5	N	6	S	7
275E, 375E (P12018 ⇒) 290E, 390E (P06156 ⇒) 365, 375, 390 (B18009 ⇒) 396		30/495-61 (3764027M2)		30/495-61 (3764027M2)		30/497-16 (3426312M1)		30/497-16 (3426312M1)
Pos.	Fig.	4	N	5	N	6	S	7
353/LX/S, 363/LX/S, 373/LX/S, 377, 383/LX/S, 387, 393/LX/S/TLX, 397/T, 1007		30/495-37 (3426336M1)		30/495-37 (3426336M1)		30/497-16 (3426312M1)		30/497-16 (3426312M1)
Pos.	Fig.	4	N	5	N	6	S	7
354, 364, 374, 384, 394 AP/AQP(X)/FQE(X)/SP(X)/SQ		30/495-69 (3428955M1)		30/495-69 (3428955M1)		30/497-16 (3426312M1)		30/497-16 (3426312M1)
Pos.	Fig.	4	N	5	N	6	S	7
398 (B18009 ⇒) 399		30/495-62 (3764028M2)		30/495-62 (3764028M2)		30/497-16 (3426312M1)		30/497-16 (3426312M1)
Pos.	Fig.	1	A	2	A	3	M	
595 (Moten/ Engine ⇒ 204021)						30/497-27 (1809676M91)		
Pos.	Fig.	30/495-34 (3426773M3)		30/495-34 (3426773M3)		3	M	
595 (Moten/ Engine 204022 ⇒)						30/497-18 (1617826M94)		
Pos.	Fig.	1	A	2	A			
1014 1114 (⇒ 2423U38036)		30/495-40 (1617829M1)		30/495-40 (1617829M1)				
Pos.	Fig.	4	N	5	N	6	S	7
1114 (2423U38037 ⇒) 1134		30/495-41 (3426276M1)		30/495-41 (3426276M1)		30/497-17 (3426255M1)		30/497-17 (3426255M1)
Pos.	Fig.	1	A	2	A	3	M	
2620, 2625, 2640, 2645, 2680, 2685, 2720, 2725		30/495-34 (3426773M3)		30/495-40 (1617829M1)		30/497-19 (3426660M1)		

Les références des pièces sont indicatives.
Nos pièces ne sont pas d'origine

Part numbers are quoted for reference purposes only.
Our parts and accessories are not original.



**ROTULES & TIRANTS DE DIRECTION (4RM)
TIE RODS & SOCKETS (4WD)**

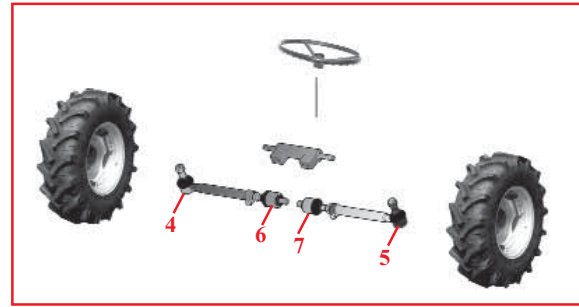

Pos.	Fig.	4	N	5	N	6	S	7	S
3050 (⇒ D066031), 3060, 3065 (⇒ D030029)		30/495-37 (3426336M1)		30/495-37 (3426336M1)					
Pos.	Fig.	4	N	5	N				
3050 (D066032 ⇒), 3060, 3065 (D030030 ⇒) (AG85)		30/495-61 (3764027M2)		30/495-61 (3764027M2)					
Pos.	Fig.	4	N	5	N				
3070, 3080, 3090, 3115, 3075, 3085 (⇒ D062001), 3095, 3120 (⇒ C320038)		30/495-38 (3426313M1)		30/495-38 (3426313M1)		30/497-16 (3426312M1)		30/497-16 (3426312M1)	
Pos.	Fig.	4	N	5	N				
3075, 3085 (D062002 ⇒) (AG105)		30/495-62 (3764028M2)		30/495-62 (3764028M2)					
Pos.	Fig.	4	N	5	N	6	S	7	S
3095, 3120 (C320039 ⇒) (AG125)		30/495-63 (3764024M1)		30/495-63 (3764024M1)		30/497-17 (3426255M1)		30/497-17 (3426255M1)	
Pos.	Fig.	4	N	5	N	6	S	7	S
3210, 3220, 3225, 3235		30/495-69 (3428955M1)		30/495-69 (3428955M1)		30/497-16 (3426312M1)		30/497-16 (3426312M1)	
Pos.	Fig.	1	A	2	A	3	M		
3610, 3630, 3650 (⇒ V289024) (Angle de rotation 40° <i>turning angle</i>)		30/495-34 (3426773M3)		30/495-40 (1617829M1)		30/497-19 (3426660M1)			
Pos.	Fig.	4	N	5	N	6	S	7	S
3610, 3630, 3650 (V289025 ⇒) (Angle de rotation 50° <i>turning angle</i>)		30/495-41 (3426276M1)		30/495-41 (3426276M1)					
3125, 3635, 3645, 3655 (⇒ C278048) 3670, 3680, 3690 (⇒ C278014)									
Pos.	Fig.	4	N	5	N				
3635, 3645, 3655 (C278049 ⇒) (⇒ E010033)		30/495-65 (3764132M1)		30/495-65 (3764132M1)		30/497-17 (3426255M1)		30/497-17 (3426255M1)	
Pos.	Fig.	4	N	5	N				
3635, 3645, 3655 (C278049 ⇒) (E010034 ⇒)		30/495-64 (3764286M1)		30/495-64 (3764286M1)					
Pos.	Fig.	4	N	5	N				
3670, 3690 (C278015 ⇒)		30/495-66 (3429731M1)		30/495-66 (3429731M1)					
Pos.	Fig.	4	N	5	N	6	S	7	S
4215, 4220, 4225, 4235, 4240, 4245, 4255, 4265, 4315, 4320, 4325, 4335, 4345, 4355 (Étroit / <i>Narrow</i>)		30/495-120 (3429173M3)		30/495-120 (3429173M3)		30/497-105 (3428268M1)		30/497-105 (3428268M1)	
Pos.	Fig.	4	N	5	N				
4225, 4235, 4240, 4325, 4335 (AG66)		30/495-121 (3428818M2)		30/495-121 (3428818M2)					
Pos.	Fig.	4	N	5	N	6	S	7	S
4225, 4235, 4240, 4245, 4255, 4260, 4265, 4270, 4325, 4335, 4345, 4355, 4360, 4365, 4370 (AG 75 & G 85)		30/495-61 (3764027M2)		30/495-61 (3764027M2)		30/497-16 (3426312M1)		30/497-16 (3426312M1)	
Pos.	Fig.	4	N	5	N				
4245, 4255, 4260, 4265, 4270, 4345, 4355, 4360, 4365, 4370 (AG 105)		30/495-62 (3764028M2)		30/495-62 (3764028M2)					

Les références des pièces sont indicatives.
Nos pièces ne sont pas d'origine

Part numbers are quoted for reference purposes only.
Our parts and accessories are not original.



"THE RELIABLE SERVICE"



ROTULES & TIRANTS DE DIRECTION (4RM)
TIE RODS & SOCKETS (4WD)

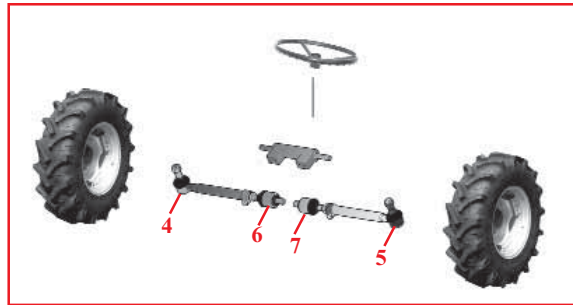

Pos.	Fig.	4	N	5	N	6	S	7	S		
6110, 6120, 6130, 6140		30/495-61 (3764027M2)		30/495-61 (3764027M2)		30/497-16 (3426312M1)		30/497-16 (3426312M1)			
Pos.	Fig.	4	N	5	N						
6150, 6160, 6235, 6245, 6255, 6260, 6265		30/495-62 (3764028M2)		30/495-62 (3764028M2)							
Pos.	Fig.	4	N	5	N	6	S	7	S		
6170, 6180, 6270, 6280		30/495-63 (3764024M1)		30/495-63 (3764024M1)		30/497-17 (3426255M1)		30/497-17 (3426255M1)			
Pos.	Fig.	4	N	5	N						
6190, 6290		30/495-64 (3764286M1)		30/495-64 (3764286M1)							
Pos.	Fig.	4	N	5	N	6	S	7	S		
8110, 8120, 8130, 8140 (⇒ E010033)		30/495-65 (3764132M1)		30/495-65 (3764132M1)		30/497-17 (3426255M1)		30/497-17 (3426255M1)			
Pos.	Fig.	4	N	5	N						
8110, 8120, 8130, 8140 (E010034 ⇒) 8210, 8220, 8240, 8250, 8260		30/495-64 (3764286M1)		30/495-64 (3764286M1)							
Pos.	Fig.	4	N	5	N						
8150, 8160		30/495-66 (3429731M1)		30/495-66 (3429731M1)							
 4 Chargeurs télescopiques / Telescopic handlers											
Pos.	Fig.	4	N	5	N	6	S	7	S		
8925, 8925T, 8926, 8926T		30/495-246 (4233443M1)		30/495-246 (4233443M1)		30/497-191 (4232169M1)		30/497-191 (4232169M1)			
Pos.	Fig.	4	N	5	N						
8937, 8937T, 8939, 8939T		30/495-247 (4232264M1)		30/495-247 (4232264M1)							

CACHES-POUSSIÈRE & COLLIERS DE SERRAGE
DUST PROTECTORS & CLAMPS

Caches-poussière / Dust protectors					Colliers / Clamps		
Réf. Ref.	Fig.	Ø int. Inner Ø	Ø ext. Outer Ø	Hauteur Height	Réf. Ref.	Fig.	Ø
70/499-3	1	17	45	14	70/2309-1	6	20
70/499-4	2	32	50	19	70/2309-2		22
70/499-5	3	19	51	23	70/2309-3		24
70/499-6	1	14	29	16	70/2309-4		26
70/499-7	4	17	42	12	70/2309-5		28
70/499-8	5	17	43	26	70/2309-6		30
70/499-9	5	17	45	18	70/2309-7		32
70/499-10	4	17	45	18	70/2309-8		36



Les références des pièces sont indicatives.
Nos pièces ne sont pas d'origine

Part numbers are quoted for reference purposes only.
Our parts and accessories are not original.



**BRAS DE DIRECTION
STEERING ARMS**

**DIRECTION MANUELLE
MANUAL STEERING**

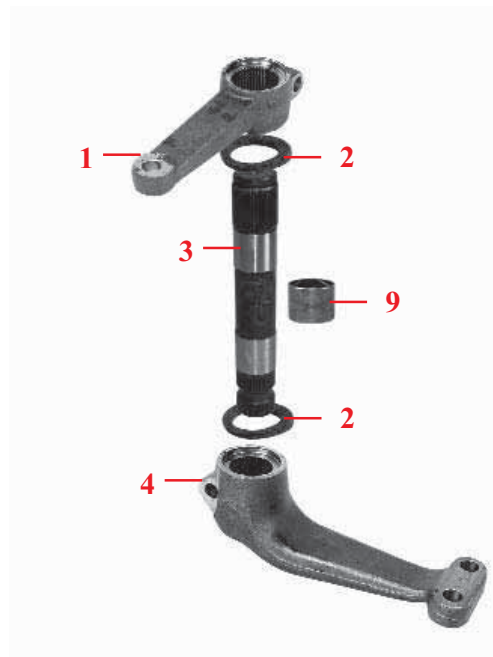

Tracteurs Tractors	Fig.	Réf. Ref.	OEM	Description	Observation
165, 168, 175, 178, 185, 188, 265, 275, 285, 290, 375E (A), 390E (A)	1	30/501-1	898354M1 1875775M1	Bras de direction Steering arm	
	2	30/504-1	196079M1	Joint étanchéité Oil seal	
	3	30/505-1	898023M2 1876390M92	Arbre Shaft	Pon vis Ø/2"pon bras 30/506-1 For screw 1/2" for arm 30/506-1
		30/505-3	1676666M1	Arbre Shaft	Pon vis Ø/8"pon bras 30/506-2 Replace 30/505-1 + 30/506-1 For screw 5/8" for arm 30/506-2 Replace 30/505-1+30/506-1
	4	30/506-1	897923M2 1876391M92	Bras de direction Steering arm	Pon vis Ø/2"pon arbre 30/505-1 For screw 1/2" for shaft 30/506-1
		30/506-2	1676664M1	Bras de direction Steering arm	Pon vis Ø/8"pon arbre 30/505-3 Replace 30/506-1+30/505-1 For screw 5/8" for shaft 30/505-3 Replace 30/505-1+30/506-1
	9	30/487-1	897235M1	Bagu Bush	Safi 175, 178 (724935 ⇔) Except 175,178 (724935 ⇔)

(A) Sur 375E et 390E se monte avec vis 5/8"existe / 375E and 390E are only fitted with screw 5/8"

Les références des pièces sont indicatives.
Nos pièces ne sont pas d'origine

Part numbers are quoted for reference purposes only.
Our parts and accessories are not original.



**BRAS DE DIRECTION
STEERING ARMS**

**DIRECTION ASSISTEE
POWER STEERING**



Tracteurs Tractors	Fig.	Réf. Ref.	OEM	Description	Observation
165, 168, 175, 178, 185, 188, 265, 275, 285, 290, 390E (A), 375E (A)	5	30/502-1A	363654X1 353436X1	Ecrou Nut	Ecrou 3/4" pour goujon 30/502-1 Nut 3/4" for fixing pin 30/502-1
	6	30/500-2	1671335M1	Bras de direction Steering arm	Remplace 898358M1 Replace 898358M1
	7	30/502-1	182725M1 829458M92	Goujon Fixing pin	
	1	30/501-2	898355M91	Bras de direction Steering arm	Bague 30/503-1 (190560M1) incluse Bush 30/503-1 (190560M1) included
	8	30/503-1	190560M1	Bague Bush	
	2	30/504-1	196079M1	Joint étanchéité Oil seal	
	3	30/505-2	898359M2	Arbre Shaft	Pon vis Ø/2" pour bras 30/506-1 For screw 1/2" for arm 30/506-1
		30/505-4	1676665M1	Arbre Shaft	Pon vis Ø/8" pour bras 30/506-2 Remplace 30/505-2 + 30/506-1 For screw 5/8" for arm 30/506-2 Replace 30/505-2+30/506-1
	4	30/506-1	897923M2 1876391M92	Bras de direction Steering arm	Pon vis Ø/2" pour arbre 30/505-2 For screw 1/2" for shaft 30/506-2
		30/506-2	1676664M1	Bras de direction Steering arm	Pon vis Ø/8" pour arbre 30/505-4 Remplace 30/505-2+30/506-1 For screw 5/8" for shaft 30/505-4 Replace 30/505-2+30/506-1
2	30/487-1	897235M1	Bague Bush		

(A) Sur 375E et 390E se monte avec vis 5/8" existe / 375E and 390E are only fitted with screw 5/8"

Les références des pièces sont indicatives.
Nos pièces ne sont pas d'origine

Part numbers are quoted for reference purposes only.
Our parts and accessories are not original.



**BRAS DE DIRECTION
STEERING ARMS**

**DIRECTION HYDROSTATIQUE
HYDROSTATIC STEERING**



Tracteurs Tractors	Fig.	Réf. Ref.	OEM	Description	Observation
565, 575, 590, 675, 690	1	30/501-2	898355M91	Bras de direction Steering arm	Bagu 30/503-1 (190560M1) inch Bush 30/503-1 (190560M1) included
	8	30/503-1	190560M1	Bagu Bush	
	2	30/504-1	196079M1 196082M1	Joint étanchéité Oil seal	
	3	30/505-3	1676 666M1	Arbre Shaft	
	4	30/506-2	1676664M1	Bras de direction Steering arm	
	9	30/487-1	897235M1	Bagu Bush	

Les références des pièces sont indicatives.
Nos pièces ne sont pas d'origine

Part numbers are quoted for reference purposes only.
Our parts and accessories are not original.



**BRAS DE DIRECTION
STEERING ARMS**

**TRACTEURS INDUSTRIELS
INDUSTRIAL TRACTORS**



	1	7	8	2	3	9	4
Tracteurs Tractors	Bras Arm	Goujon Fixing pin	Bague Bush	Joint Dust seal	Arbre Shaft	Bague Bush	Bras Arm
30D	30/501-2 (898355M91)	30/502-1 (182725M1)	30/503-1 (190560M1)	30/504-1 (196079M1)	Hydrostatique Hydrostatic 30/505-3 (1676666M1)	30/487-1 (897235M1)	30/506-2 (1676664M1)
30E					Dir. assistée Power steering 30/505-4 (1676665M1)		
50, 50B					⇒ 875176 30/505-2 (898359M2)	30/487-1 (897235M1)	30/506-2 (1676664M1)
50B MKII					875177 ⇒ 30/505-4 (1676665M1)		
50D					30/505-4 (1676665M1)		
50H, 50HX					30/505-3 (1676666M1)		30/506-2 (1676664M1)

Les références des pièces sont indicatives.
Nos pièces ne sont pas d'origine

Part numbers are quoted for reference purposes only.
Our parts and accessories are not original.



**DIRECTION
STEERING**

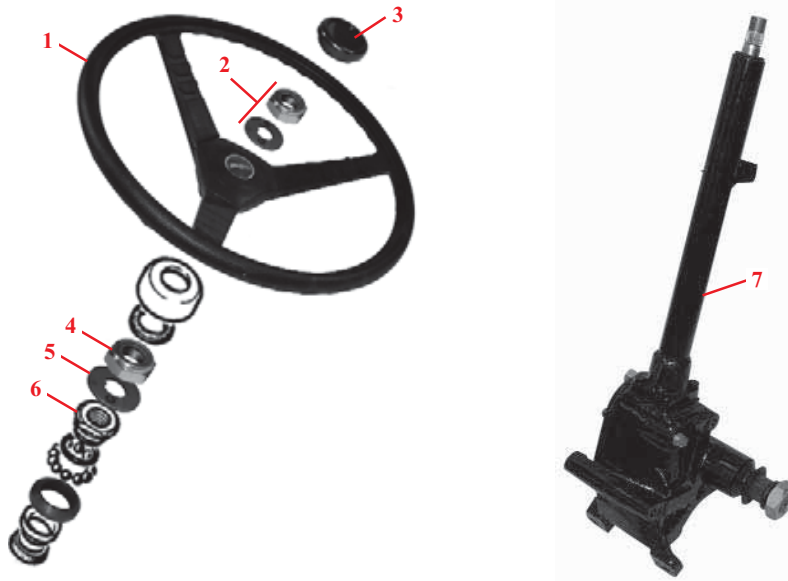

Fig.	1	2	3	4	5	6	7
Tracteurs Tractors	Volant Steering wheel	Ecrou et rondelle Nut & washer	Chapeau Cap	Ecrou Nut	Rondelle Tab washer	Cuvette Adj ball race	Boîtier dir. Steer.assy
TEA20, TED20, TEF20	30/510-1 (15) (180576M1, 899623M1)	30/512-1 (195592M1+ 180577M1)					
35, 135, 148				30/515-1 (1850034M1, 3900193M1)	30/516-1 (1850053M91, 3900212M91)	30/517-1 (1850033M1, 3900182M1)	
135 (19.6/1 ratio)	30/510-4 (30) (1673006M1, 1691798M1)		30/511-4 (3759496M91)				30/514-14 (1673663M91)
65, 765	30/510-1 (899623M1)	30/512-1 (195592M1+ 180577M1)					
158				30/515-1 (1850034M1, 3900193M1)	30/516-1 (1850053M91, 3900212M91)	30/517-1 (1850033M1, 3900182M1)	
165, 168, 185, 188, 265, 275, 285, 290, 290E, 375E, 390, 390E	30/510-2 (1671945M1, 960840M1, 894737M91)		30/511-2 (3759758M92)	30/515-2 (1853123M1, 525743M1)			30/514-5 (1687020M92)
175, 178, 550, 565, 575, 590							
230, 240, 250	30/510-4 (1673006M1, 1691798M1, 3774836M1)		30/511-4 (3759496M91)	30/515-1 (1850034M1, 3900193M1)	30/516-1 (1850053M91, 3900212M91)	30/517-1 (1850033M1, 3900182M1)	30/514-14 (1673663M91)
235, 245, 255, 260							
595	30/510-2 (1671945M1)						
675, 690, 698, 698T, 699			30/511-2 (3759758M92)				
1200, 1250	30/510-2 (1671945M1)			30/515-2 (1853123M1)			
2620, 2640, 2645							

Les références des pièces sont indicatives.
Nos pièces ne sont pas d'origine

Part numbers are quoted for reference purposes only.
Our parts and accessories are not original.



**DIRECTION
STEERING**

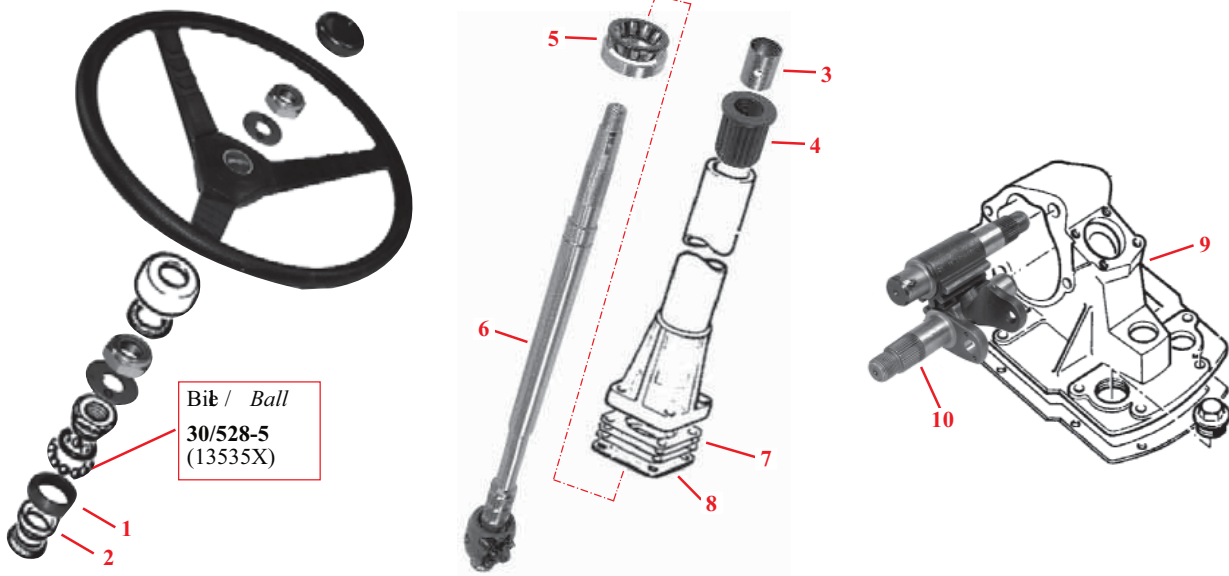

Biè / Ball
30/528-5
(13535X)

Fig.	1	2	3	4	5
Tracteurs <i>Tractors</i>	Cône <i>Sphere ball race</i>	Rondelle <i>Ball race ring</i>	Bague <i>Bush</i>	Bague <i>Bush</i>	Roulement <i>Bearing</i>
35, 135, 145, 148, 152, 155, 158, 230, 235, 240, 245, 250, 255, 260	30/520-1 (1850032M1, 3900183M1)	30/521-1 (1850031M1)			
165, 168, 175, 178, 185, 188, 265, 275, 285, 290			30/525-1 (1853112M1)	30/526-1 (1853210M1)	30/529-1 (1883133M91, 880951M91)

Fig.	6	7	8	9	10
Tracteurs <i>Tractors</i>	Arbre <i>Steering shaft</i>	Epaisseur <i>Shim</i>	Joint <i>Gasket</i>	Boitier <i>Box</i>	Arbre prim. (man.) <i>Rocker shaft (man.)</i>
35, 133 135 (⇒ 400000) 140, 152	30/530-1 (1850003M92) L = 534 m				30/535-4 (A) (1861704M1)
135 (400001 ⇒) 148	30/530-2 (1867192M91) L = 570 m				30/535-4 (1850016M1, 1861704M1)
135 (19.6/1 Ratio)	30/530-6 (1890727M91)				30/535-8 (1889567M1, 3900188M1)
152, 155, 158					30/535-4 (1861704M1)
165 (⇒ 100000) 175, 178		30/531-1 (1853118M1)	30/532-1 (1802857M2, 1853121M1)	30/533-2 (1853098M91)	
165 (100001 ⇒) 168, 185, 188	30/530-5 (1805743M92)				
230, 235, 240, 245, 250, 255, 260	30/530-6 (1890727M91)				30/535-8 (1889567M1)
265 (⇒ 193552) 275 (⇒ 221522) 290 (⇒ 387020)	30/530-5 (1805743M92)	30/531-1 (1853118M1)	30/532-1 (1853121M1)	30/533-2 (1853098M91)	
265, 275, 285, 290 <i>Derniers / Late</i>	30/530-14 (3473254M1)				

(A) **30/535-4** doit être monté avec le pivot **30/537-2** (1861583M1)
(A) **30/535-4** must be fitted with **30/537-2** (1861583M1)

Les références des pièces sont indicatives.
Nos pièces ne sont pas d'origine

Part numbers are quoted for reference purposes only.
Our parts and accessories are not original.



**DIRECTION
STEERING**

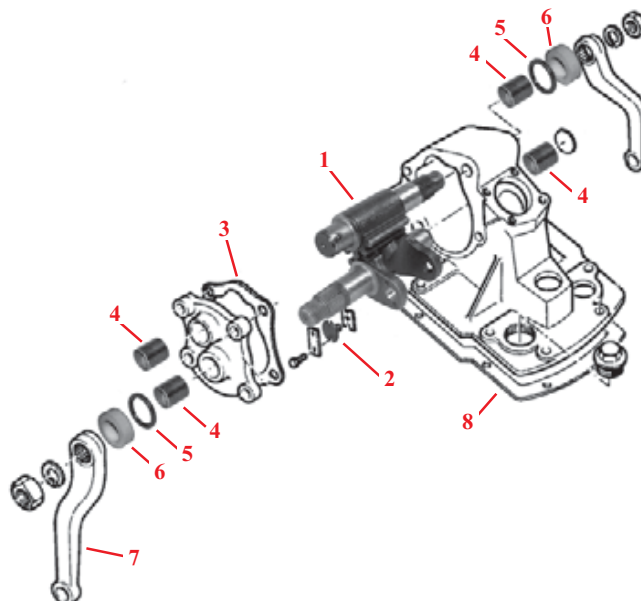

Fig.	1	2	3
Tracteurs Tractors	Arbre secondaire Rocker shaft	Arbre secondaire Rocker shaft	Pivot Ball peg
35	Direct. manuë Manual steering 30/536-1 (1850017M1)	Direct. assistée Power steering 30/536-2 (828993M1)	30/537-1 (1850025M1)
133 135 (⇒ 155522) 140, 148			30/541-2 (1850041M1)
135 (155523 ⇒) 230, 235, 240, 245, 250, 255, 260		30/537-2 (1861583M1)	
152, 158			
165, 168, 175, 178, 185, 188, 265, 275, 285			30/541-1 (1853115M1)

Fig.	4	5	6	7	8
Tracteurs Tractors	Bague Bush	Bague etanch. Inner oil seal	Joint feutre Outer felt seal	Bielle primaire Drop arm prim.	Joint Gasket
35, 133, 135, 145, 148, 152, 158, 230, 235, 240, 245, 250, 255, 260	1^{1/4}"x 1^{3/8}" 30/543-1 (1850018M1)	30/544-1 (1850019M1, 1893623M1, 195925M1)	30/545-1 (1850020M1, 3900202M1)	Direct. manuë Manual steering 30/546-1 (1850021M1, 3900210M1)	30/550-1 (180511M2)
65, 765	1^{1/2}"x 1^{5/8}" 30/543-2 (1850517M1)	30/544-2 (1850519M1)	30/545-2 (1884245M1)		
165, 168, 174, 175, 178, 184, 185, 188, 194, 234, 254, 274					
265 (⇒ 198199) 275 (⇒ 222184), 285 290 (⇒ 390002)					

Les références des pièces sont indicatives.
Nos pièces ne sont pas d'origine

Part numbers are quoted for reference purposes only.
Our parts and accessories are not original.



"THE RELIABLE SERVICE"



**PONT AVANT 4RM
4 WD FRONT AXLE**

Support de l'arbre / Front axle support

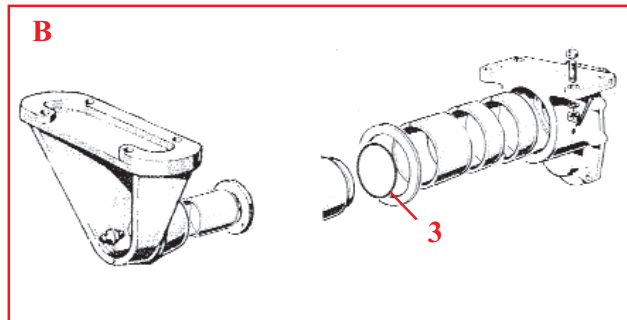
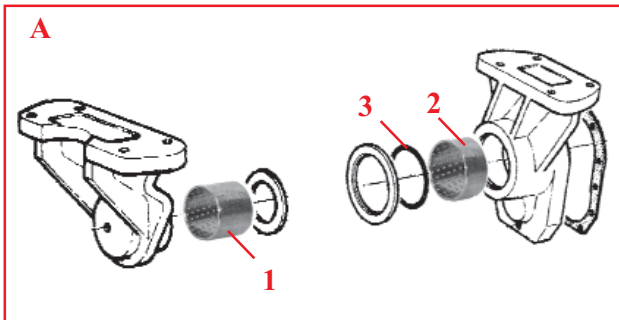

Fig.			1	2	3
Tracteurs Tractors	Fig. Fig.	Pont Axle	Bague avant Front bush	Bague arrière Rear bush	Bague Seal
Ponts Landini Axles					
275, 285, 290 (France) 575, 590 - 675, 690 (⇒ 1984 Cat.2)	A	Cat. 2	30/486-41 (1823570M2)	30/486-48 (3426220M1)	30/6489-5 (392082X1)
275, 290, 298 (UK) - 675, 690 (⇒ 1984 Cat.2 A) 675, 690 (1984⇒ Cat.2) - 698, 698T, 699, 1004, 1004T		Cat. 2 Cat. 2.5		30/486-49 (3599061M1)	30/6489-6 (3426821M1)
168, 188 (Pont tpe 1972 type axle) 275, 285, 298, 575, 590, 592, 595, 698, 1080	B	Cat. 3			30/6489-7 (1442218X1)

Support de l'arbre / Front axle support

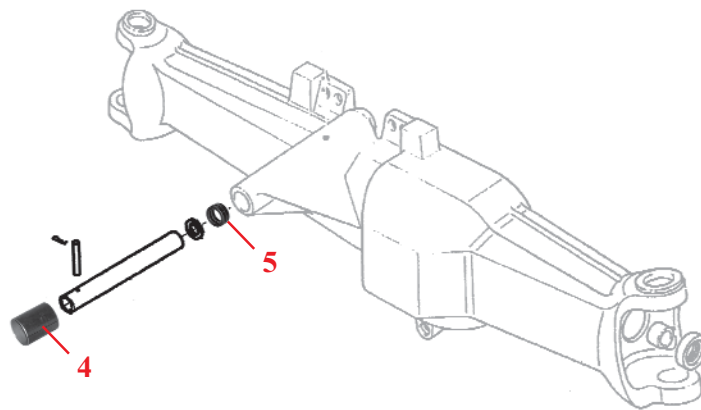

Fig.			4	5
Tracteurs Tractors	Pont Axle	Bague avant Front bush	Bague arrière Rear bush	Bague Seal
Ponts Landini Cat. 1 & NG side drive Axles				
250, 265, 340, 350, 355, 360, 362, 365, 375, 390, 390T, 396, 398, 399	Cat. 1 Cat. 2 Cat. 2.5	30/486-5 (897712M2)		
Ponts AG side drive Axles				
240, 253, 263, 275, 290, 342, 352, 362, 362N, 365, 372N, 375, 382N, 390, 390T, 396, 398, 399	AG65 AG66 AG75 AG85 AG105	30/486-5 (897712M2)		30/6489-15 (3759661M1)

Les références des pièces sont indicatives.
Nos pièces ne sont pas d'origine

Part numbers are quoted for reference purposes only.
Our parts and accessories are not original.



**PONT AVANT 4RM
4 WD FRONT AXLE**

Support de l'arbre / Front axle support

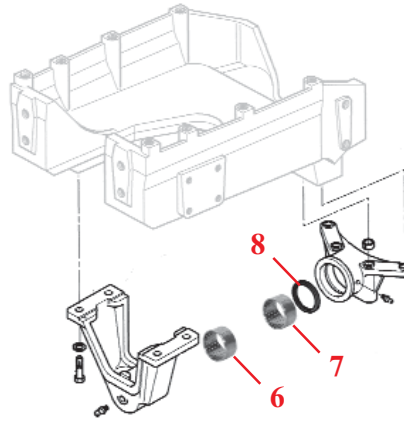

Fig.		6	7	8
Tracteurs Tractors	Pont Axle	Bague avant Front bush	Bague arrière Rear bush	Bague Seal
Ponts Landini Axles				
Voir aussi page précédente pour les ponts Landini Cat. 2, Cat. 2.5 et premiers Cat. 3 <i>See also previous page, for Cat. 2, Cat. 2.5 and early Cat. 3 Landini axles</i>				
2620, 2625, 2640, 2645, 2680, 2685, 2720, 2725	Cat. 3	30/486-43 (1611096M1)	30/486-51 (3033689M1)	30/6489-8 (365801X1)
3610, 3630, 3650 (Angl. de berge 40° <i>turning angle</i>)				
Ponts NG Axles				
3050, 3060, 3065, 3070, 3075	Cat. 1 Cat. 2 Cat. 2.5	30/486-44 (3387822M1)	1er / <i>Early</i> 30/486-52 (3384093M1)	30/6489-9 (3009884X1)
3080, 3085, 3090, 3095, 3115, 3120, 3120T	Cat. 2.5		Dernier / <i>Late</i> 30/486-53 (3619073M1)	
3125, 3140	Cat. 3 Cat. 3.5 Cat. 3.6	30/486-45 (3387823M1)	30/486-52 (3384093M1)	30/6489-10 (1441176X1)
3610, 3630, 3650 (Angl. de berge 50° <i>turning angle</i>) 3635, 3645, 3655, 3660, 3670, 3680, 3690			30/486-55 (3384406M1)	
Ponts AG Axles				
3050, 3060, 3065, 3075, 3085, 6110, 6120, 6130, 6140, 6150, 6160, 6235, 6245, 6255, 6260, 6265	AG66 AG75	76m 30/486-44 (3387822M1)	30/486-56 (3810480M1)	
4215, 4220, 4225, 4235, 4240, 4245, 4255, 4260, 4265, 4270, 4315, 4320, 4325, 4335, 4345, 4355, 4360, 4365, 4370	AG85 AG105 AG105L	86m 30/486-46 (3712078M1)		
3095, 3120, 6170, 6180, 6270, 6280	AG125		30/486-57 (3712152M1)	30/6489-13 (3010457X1)
3635, 3645, 3655, 3670, 3690, 6190, 6290, 8110, 8120, 8130, 8140, 8150, 8160	AG155 AG200	⇒ 3/99 86m 30/486-46 (3712078M1)	30/486-58 (3712072M1)	30/6489-14 (3010428X1)
8210, 8220, 8240	AG155H			

Les références des pièces sont indicatives.
Nos pièces ne sont pas d'origine

Part numbers are quoted for reference purposes only.
Our parts and accessories are not original.



**PONT AVANT 4RM
4 WD FRONT AXLE**

Croisillons / U-joints

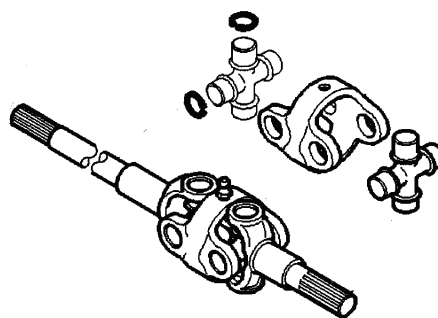
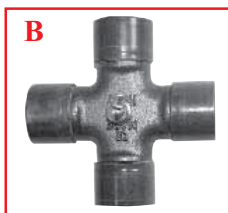
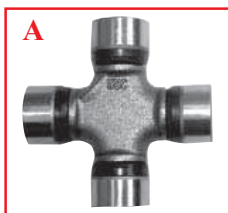

Tracteurs Tractors	Pont Axle	Croisillon U-Joint	Type	Ø x L (mm)
Ponts Schindler Axles				
240, 265, 275		30/6403-52 (1894992M1)	C	32x95.6
Ponts Landini Axles				
250, 265, 275, 285, 290, 575, 590, 675, 690	Cat. 1 Cat. 2	30/6403-1 (1423444M1)	A	27x81.7
298, 698, 698T, 699, 1004, 1004T	Cat. 2.5	30/6403-2 (1429021M1)	B	30.2x92
168, 188 (Pont type 1972 type axle) 275, 285, 298, 575, 590, 592, 595, 698, 1080, 2620, 2625, 2640, 2645, 2680, 2685, 2720, 2725 3610, 3630, 3650 (Angle de rotation 40° turning angle)	Cat. 3			
Ponts NG Axles				
340, 350, 355, 360, 362, 365, 375	Cat. 1	30/6403-4 (3427346M91)	C	27x74.5
390, 390T, 396	Cat. 2	30/6403-5 (3427352M91)		27x81.7
398, 399	Cat. 2.5	30/6403-3 (3427330M91)		30.2x92
3050	Cat. 1	30/6403-22 (3310490M91)	A	27x74.6
3055, 3060, 3065	Cat. 2	30/6403-1 (1423444M1)		27x81.7
3070, 3075, 3080, 3085, 3090, 3095, 3115, 3120, 3120T	Cat. 2.5	30/6403-2 (1429021M1)	B	30.2x92
3125, 3140	Cat. 3			
3610, 3630, 3650 (Angle de rotation 40° turning angle) 3635, 3645, 3655, 3660, 3680				
3610, 3630, 3650 (Angle de rotation 50° turning angle) 3680	Cat. 3.5	30/6403-3 (3427330M91)	C	30.2x92
3125, 3140	Cat. 3.5	30/6403-56 (3428155M91)	A	30.2x82
3635, 3645, 3655, 3660, 3670, 3690	Cat. 3.6			

Les références des pièces sont indicatives.
Nos pièces ne sont pas d'origine

Part numbers are quoted for reference purposes only.
Our parts and accessories are not original.



**PONT AVANT 4RM
4 WD FRONT AXLE**

Croisillons / U-joints

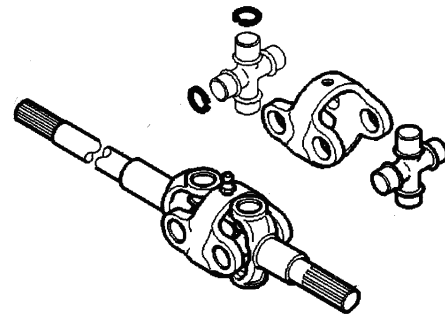
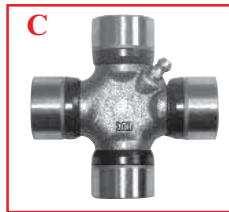
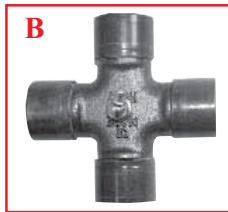
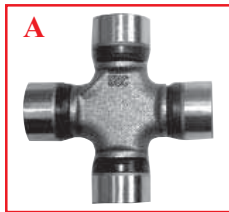

Tracteurs Tractors	Pont Axle	Croisillon U-Joint	Type	Ø x L (mm)
Ponts AG Axles				
240, 253, 342 (Différentielstandard / <i>Standard differential</i> ⇒ D37163) 240 (Différentielhydrolock / <i>Hydrolock differential</i>)	AG65	30/6403-53 (3764686M1)	A	22x55
240, 253, 342 (Différentielstandard / <i>Standard differential</i> D37164 ⇒) & Différentielstandard avec protection avant / <i>Standard differential with front fenders</i>) 262, 352 (Différentielstandard / <i>Standard differential</i>) 342, 352 (Différentielhydrolock / <i>Hydrolock differential</i>)		30/6403-21 (3427406M91, 3429727M1)		24x62
362, 362N, 372N, 382N, 4215, 4220, 4225, 4235, 4245, 4315, 4320, 4325, 4335, 4345	AG66			
275, 290, 365, 375, 390, 390T, 396, 398, 399, 4225, 4235, 4240, 4245, 4255, 4260, 4265, 4270, 4325, 4335, 4345, 4355, 4360, 4365, 4370	AG75 AG85 AG105 AG105L	GKN / DBM 30/6403-55 (3429996M1, 3429436M1, 3765113M1)		27x71
3050, 3060, 3065, 3075, 3085, 6110, 6120, 6130, 6140, 6150, 6160, 6235, 6245, 6255, 6260, 6265	AG85 AG105			
3095, 3120, 3635, 3645, 3655, 6170, 6180, 6190, 6270, 6280, 6290, 8110, 8120, 8130, 8140, 8210, 8220, 8240	AG125 AG155 AG155H	GKN 30/6403-56 (3428155M91)		30.2x82
		DBM 30/6403-57 (3764883M91)		30x83
3670, 3690, 8150, 8160, 8240, 8250, 8260	AG200 AG200H	GKN 30/6403-58 (3428434M91)		35x93
		DBM 30/6403-59 (3765013M91)		35x96.8

Les références des pièces sont indicatives.
Nos pièces ne sont pas d'origine

Part numbers are quoted for reference purposes only.
Our parts and accessories are not original.



**PONT AVANT 4RM
4 WD FRONT AXLE**

Jeux de joints des cylindres de direction / Steering cylinder seal kits

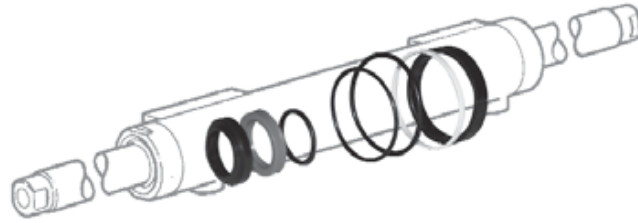

Tracteurs Tractors	Pont Axle	Jeu de joints Seal kits
Ponts Landini Axles		
168, 188, 250, 265, 275, 285, 290, 298, 575, 590, 592, 595, 675, 690, 698, 698T, 699, 1004, 1004T	Cat. 1 Cat. 2 Cat. 2.5 Cat. 3	30/494-1 (1749581M91)
2640, 2645, 2680, 2685, 2720, 2725 (Cylindre renforcé / Heavy duty cylinders) 3610, 3630, 3650 (Angle de rotation 40° turning angle)	Cat. 3	30/585-9 (3442308M91)
Ponts NG Axles		
340, 350, 355, 360, 362, 365, 375, 390, 390T, 396, 398, 399	Cat. 1 Cat. 2 Cat. 2.5	30/494-2 (3484807M91)
3050, 3060, 3065	Cat. 1 Cat. 2	30/494-3 (3484327M92)
3070, 3075, 3080, 3085, 3090, 3095, 3115, 3120, 3120T	Cat. 2.5	30/585-10 (3484317M92)
3125, 3140 (⇒ R206010) 3610, 3630, 3650 (Angle de rotation 50° turning angle) 3635, 3645, 3655, 3660, 3670, 3680, 3690	Cat. 3 Cat. 3.5 Cat. 3.6	30/585-11 (3484624M92)
3125, 3140 (R206011 ⇒)		30/585-5 (3443433M93)

Tracteurs Tractors	Pont Axle	Jeu de joints Seal kits
Ponts AG Axles		
240, 253, 263, 342, 352, 362, 362N, 372N, 382N, 4215, 4220, 4225, 4235, 4240, 4245, 4315, 4320, 4325, 4335, 4345	AG65 AG66	30/585-12 (3488643M91)
275, 290, 365, 375, 390, 390T, 398, 399, 3050, 3060, 3065, 4225, 4235, 4245, 4255, 4260, 4265, 4270, 4325, 4335, 4345, 4355, 4360, 4365, 4370, 6110, 6120, 6130, 6140, 6235, 6245	AG75 AG85 AG105 AG105L	Pacom 30/494-3 (3484327M92) Ognibne 30/585-13 (3765414M91)
3075, 3085, 3095, 3120, 6150, 6160, 6170, 6180, 6255, 6260, 6265, 6270, 6280	AG105 AG125	Pacom 30/585-14 (3624121M91) Ognibne 30/585-15 (3765808M91)
6190, 6290	AG155	30/585-5 (3443433M93)
3635, 3645, 3655, 3670, 3690 8110, 8120, 8130, 8140 (AG155 ⇒ 4246BG) 8150, 8160 (AG200 ⇒ 2020BG)	AG155 AG200	30/585-11 (3484624M92)
8110, 8120, 8130, 8140 (AG155 4247BG ⇒) 8150, 8160 (AG200 2021BG ⇒)		30/585-16 (3624903M91)
8210, 8220, 8240, 8250, 8260	AG155H AG200H	

Jeux de réparation des arbres de transmission / Speedi-sleeve kit

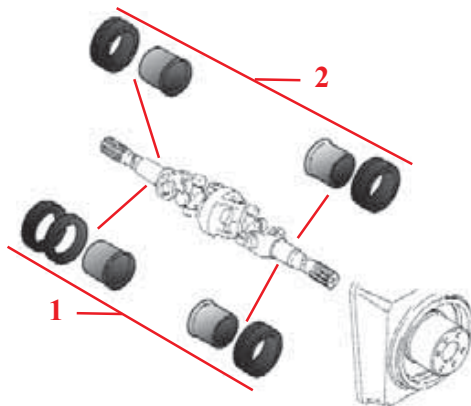

Tracteurs Tractors	Pont Axle	Fig. Fig.	Jeu de réparation Speedi-sleeve kit
Ponts NG Axles			
340, 350, 355, 360, 362, 365, 375, 390, 390T, 396, 398, 399	Cat. 1 Cat. 2 Cat. 2.5	1	⇒ 1992 30/6416-1 (3763364M91)
		2	1992 ⇒ 30/6416-2 (3763366M91)

Les références des pièces sont indicatives.
Nos pièces ne sont pas d'origine

Part numbers are quoted for reference purposes only.
Our parts and accessories are not original.



**PONT AVANT 4RM
4 WD FRONT AXLE**

Bagues & joints de boîtier & d'arbre / Axle housing & half shaft bushes & seals

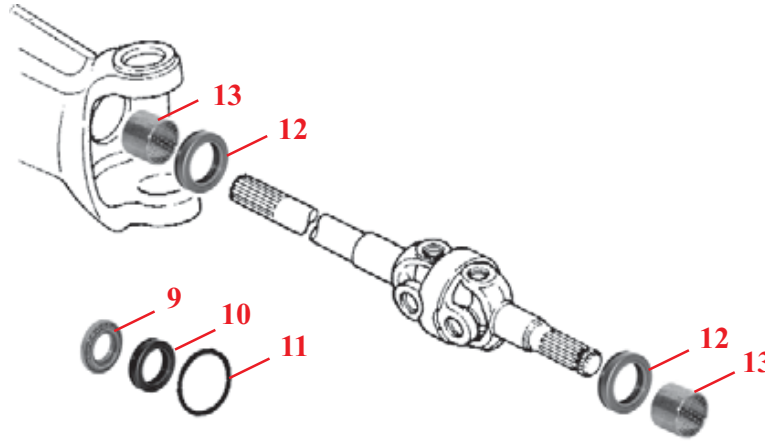

Fig.		9	10	11	12	13
Tracteurs Tractors	Pont Axle	Bague/roul. int. In. bush/bearing	Bague int. In. oil seal	O-ring 'O' Ring	Bague ext. Out. oil seal	Bague/roul. ext. Out. bush/bearing
Ponts Landini Axles						
250, 265, 275, 285, 290, 298, 575, 590, 675, 690, 698, 698T, 699, 1004, 1004T	Cat. 1 Cat. 2 Cat. 2.5	30/6412-2 (390984X1)	30/6407-1 (392107X1)	30/6409-6 (1441885X1)	30/6407-4 (392108X1)	30/6462-15 (1823602M1)
168, 188 (Pont tpe 1972 type axle) 275, 285, 298, 575, 590, 592, 595, 698, 1080	Cat. 3	30/6412-3 (2714087M1)	30/6409-2 (1442250X1)		30/6409-2 (1442250X1)	30/6412-1 (1442252X1)
2620, 2625, 2640, 2645, 2680, 2685, 2720, 2725 3610, 3630, 3650 (Angè de rotation 40° timing angè)	Cat. 3	30/6412-4 (1440912X1)	30/6409-3 (395523X1)	30/6409-7 (1441546X1)	30/6407-18 (395522X1)	30/6462-16 (1617854M1)
Ponts NG Axles						
340, 350, 355, 360, 362, 365, 375, 390, 390T, 396, 398, 399, 3050, 3060, 3065, 3070, 3075, 3080, 3085, 3090, 3095, 3115, 3120, 3120T, 3125, 3140 3610, 3630, 3650 (Angè de rotation 50° timing angè)	Cat. 1 Cat. 2 Cat. 2.5 Cat. 3 Cat. 3.5 Cat. 3.6	30/6462-1 (3426938M1)	30/6411-1 (3429001X1) 40x68x14 30/6409-1 (3428064M1) 40x60x18.5		30/6407-2 (3019957X1) 40x55x10 30/6407-3 (3429002X1) 40x55x7.2 30/6409-1 (3428064M1) 40x60x18.5	30/6462-1 (3426938M1)
Ponts AG Axles						
240, 253, 263, 342, 352, 362, 362N, 372N, 382N, 4215, 4220, 4225, 4235, 4245 4315, 4320, 4325, 4335, 4345	AG65 AG66	30/6462-13 (3428834M1)	30/6409-4 (3428829M1)		30/6409-4 (3428829M1)	30/6462-17 (3427870M1)
275, 290, 365, 375, 390, 390T, 396, 398, 399, 3050, 3060, 3065, 3075, 3085, 4225, 4235, 4240, 4245, 4255, 4260, 4265, 4270, 4325, 4335, 4345, 4355, 4360, 4365, 4370, 6110, 6120, 6130, 6140, 6150, 6160, 6235, 6245, 6255, 6260, 6265	AG75 AG85 AG105 AG105L	30/6462-14 (3428571M1)	30/6409-5 (3428521M2)		30/6409-5 (3428521M2)	30/6462-14 (3428571M1)
3095, 3120, 3635, 3645, 3655, 3670, 3690, 6170, 6180, 6190, 6270, 6280, 6290, 8110, 8120, 8130, 8140, 8150, 8160	AG125 AG155 AG200	30/6462-1 (3426938M1)	30/6409-1 (3428064M1)		30/6409-1 (3428064M1) 40x60x18.5	30/6462-1 (3426938M1)
8210, 8220, 8240, 8250, 8260	AG155H AG200H				30/355-6 (3428942M1) 55x82x16.5	30/6462-18 (3764875M1)

Les références des pièces sont indicatives.
Nos pièces ne sont pas d'origine

Part numbers are quoted for reference purposes only.
Our parts and accessories are not original.



**PONT AVANT 4RM
4 WD FRONT AXLE**

Pivots, roulements et joints / Pivot pins, bearings & seals

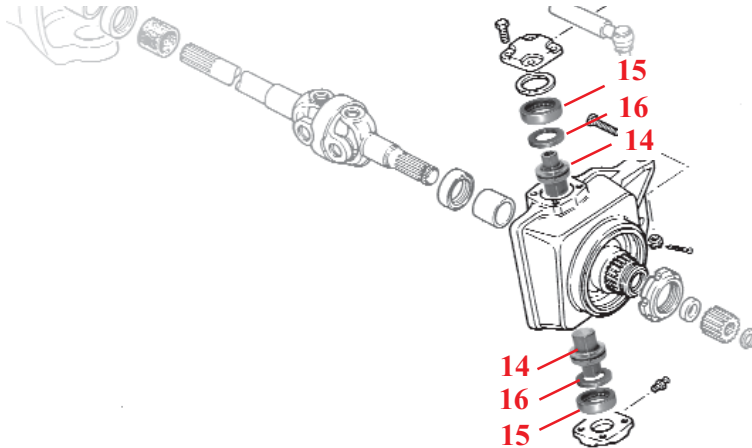

Fig.	Pont Axle	14		15		16	
		Pivot / Pivot pin		Roulement / Bearing		Joint / Seal	
Tracteurs Tractors		1er / Early	Dernier / Late	1er / Early	Dernier / Late	1er / Early	Dernier / Late
Ponts Landini & NG Axles							
250, 265, 275, 290 (UK) 675, 690	Cat. 1 Cat. 2	30/6450-16 (1427449M3)	30/6450-7 (3426523M2)	30/6451-15 (1427448M1)	30/6410-20 (3310930M91)	30/6452-12 (392184X1)	30/6452-13 (1442524X1)
275, 285, 290 (France) 575, 590	Cat. 2	30/6450-17 (1823560M1)	30/6450-16 (1427449M3)	30/353-7 (1442550X1)	30/6451-15 (1427448M1)	30/6452-11 (1823575M1)	30/6452-12 (392184X1)
340, 350, 355, 360, 362, 365, 375, 390, 390T, 396, 3050, 3060, 3065	Cat. 1 Cat. 2	30/6450-7 (3426523M2)		30/6410-20 (3310930M91)		30/6452-14 (3009744X1)	
298, 698, 698T, 699, 1004, 1004T	Cat. 2.5		30/6450-8 (3426332M1)	30/6451-18 (3426152M1)	30/6451-17 (3426619M1)	30/6452-15 (1442682X1)	30/6452-16 (371153X1)
398, 399, 3070, 3075, 3080, 3085, 3090, 3095, 3115, 3120, 3120T	Cat. 2.5	30/6450-8 (3426332M1)		30/6451-17 (3426619M1)		30/6452-16 (371153X1)	
168, 188 (Pont type 1972 type axle) 275, 285, 298, 575, 590, 592, 595, 698, 1080	Cat. 3			30/354-7 (1442253X1)		30/6420-1 (1441550X1)	
2620, 2640, 2680, 2720	Cat. 3		30/6450-8 (3426332M1)	30/6451-16 (1617846M1)	30/6451-17 (3426619M1)	30/6452-17 (1426114M1)	30/6452-16 (371153X1)
2625, 2645, 2685, 2725, 3125, 3140, 3610, 3630, 3635, 3645, 3650, 3655, 3660, 3670, 3680, 3690	Cat. 3 Cat. 3.5 Cat. 3.6	30/6450-8 (3426332M1)		30/6451-17 (3426619M1)		30/6452-16 (371153X1)	
Ponts AG Axles							
240, 253, 263, 342, 352, 362, 362N, 372N, 382N, 4215, 4220, 4225, 4235, 4245, 4315, 4320, 4325, 4335, 4345	AG65 AG66	30/6450-20 (3429586M1)		30/6451-19 (339482X1)	30/6451-21 (3009131X1)	30/6452-18 (3428972M1)	
275, 290, 365, 375, 390, 390T, 396, 398, 399, 4225, 4235, 4240, 4245, 4255, 4260, 4265, 4270, 4325, 4335, 4345, 4355, 4360, 4365, 4370, 6235, 6245, 6255, 6260, 6265	AG75 AG85 AG105 AG105L	30/6450-9 (3429319M1)		30/6410-20 (3310930M91)		30/6452-19 (3429317M1)	
3050, 3060, 3065, 3075, 3085, 6110, 6120, 6130, 6140, 6150, 6160	AG85 AG105	⇒ 3/1/96 30/6450-7 (3426523M2)	3/1/96 ⇒ 30/6450-9 (3429319M1)			⇒ 3/1/96 30/6452-14 (3009744X1)	3/1/96 ⇒ 30/6452-19 (3429317M1)
3095, 3120, 3635, 3645, 3655, 3670, 3690, 6170, 6180, 8110, 8120, 8130, 8140, 8150, 8160	AG125 AG155 AG200	⇒ 3/1/96 30/6450-21 (3429910M1)	3/1/96 ⇒ 30/6450-22 (3429864M1)	30/6451-17 (3426619M1)		⇒ 3/1/96 30/6452-16 (371153X1)	3/1/96 ⇒ 30/6452-20 (3429318M1)
6190, 6270, 6280, 6290, 8210, 8220, 8240, 8250, 8260	AG125 AG155H AG200H	30/6450-22 (3429864M1)				30/6452-20 (3429318M1)	

Les références des pièces sont indicatives.
Nos pièces ne sont pas d'origine

Part numbers are quoted for reference purposes only.
Our parts and accessories are not original.



"THE RELIABLE SERVICE"



**PONT AVANT 4RM
4 WD FRONT AXLE**

Roulements et joints de moyeu / Hub bearings & seals

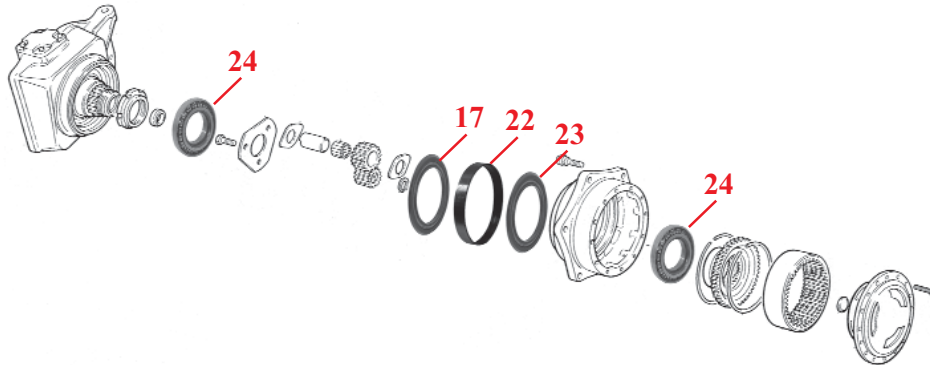

Fig.		17	22	23	24
Tracteurs Tractors	Pont Axle	Bague Oil seal	Manchon d'usure Wear sleeve	Bague Oil seal	Roul. int. & ext. In. & Out. bearing
Ponts NG Axles					
340, 350, 355, 360, 362, 365, 375, 390, 390T, 396, 3050, 3060, 3065	Cat. 1 Cat. 2	1er / Early 30/6408-2 (A) (3429791M1) 165x190x15.5/17 Dernier / Late 30/6408-1 (3429037M1) 170x195x18	1er / Early Dernier / Late 30/6417-1 (3429038M1) 165x170x20	1er / Early Dernier / Late 30/6408-6 (3428067M1) 170x182x9	30/6410-3 (3426850M2)
398, 399, 3070, 3075, 3080, 3085, 3090, 3095, 3115, 3120, 3120T, 3125, 3140 3610, 3630, 3650 (Angle de rotation 50° turning angle) 3635, 3645, 3655, 3660, 3670, 3680, 3690	Cat. 2.5 Cat. 3 Cat. 3.5 Cat. 3.6	30/6408-3 (B) (3429815M3) 195x220x14.5/18			30/6410-4 (3426851M2)
Ponts AG Axles					
240, 253, 263, 342, 352, 362, 362N, 372N, 382N 4215, 4220, 4225, 4235, 4245, 4315, 4320, 4325, 4335, 4345	AG65 AG66	30/6408-32 (3429167M1)	30/6417-5 (3429168M1)	30/6408-35 (3429169M1)	30/6410-34 (3428271M2, 3764595M1)
275, 290, 365, 375, 390, 390T, 396, 398, 399, 4225, 4235, 4240, 4245, 4255, 4260, 4265, 4270, 4325, 4335, 4345, 4355, 4360, 4365, 4370	AG75 AG85 AG105 AG105L	30/6408-1 (3429037M1) 170x195x18	30/6417-1 (3429038M1) 165x170x20	30/6408-6 (3428067M1) 170x182x9	30/6410-3 (3426850M2)
3050, 3060, 3065, 3075, 3085, 6110, 6120, 6130, 6140, 6150, 6160, 6235, 6245, 6255, 6260, 6265	AG85 AG105	30/6408-33 (3429790M2) 165x195x18			
3095, 3120, 3635, 3645, 3655, 6170, 6180, 6190, 6270, 6280, 6290, 8110, 8120, 8130, 8140, 8210, 8220, 8240	AG125 AG155 AG155H	30/6408-3 (3429815M3) 195x220x14.5/18			30/6410-4 (3426851M2)
3670, 3690, 8150, 8160, 8240, 8250, 8260	AG200 AG200H	30/6408-34 (3429889M2) 210x240x14.5/18			30/6410-35 (3428478M1)

(A) 30/6408-2 (3429791M1) replace / replaces 3019959X1 & 429004X1

(B) 30/6408-3 (3429815M3) replace / replaces 3019960X1 & 428503M1 + 3428504MM1 + 34824317M1

Les références des pièces sont indicatives.
Nos pièces ne sont pas d'origine

Part numbers are quoted for reference purposes only.
Our parts and accessories are not original.



**PONT AVANT 4RM
4 WD FRONT AXLE**

Roulements et joints de moyeu / Hub bearings & seals

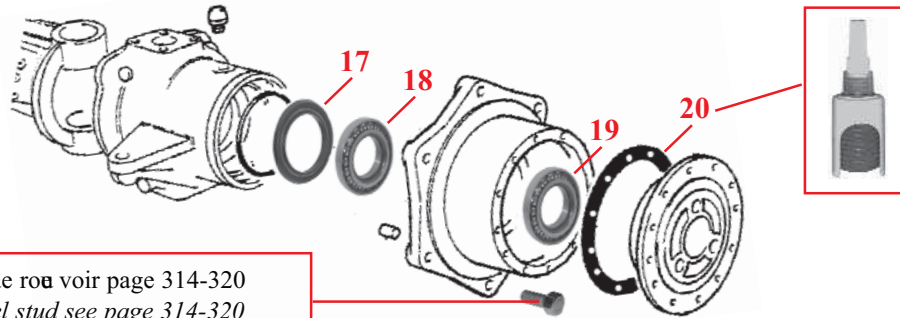

Ponts joints de rou voir page 314-320
For wheel stud see page 314-320

Fig.	Pont Axle	17 Bague Oil seal	18 Roul. int. Inner bear.	19 Roul. ext. Outer bear.	20 Joint Gasket
Ponts Landini Axles					
250, 265	Cat. 1	30/6408-5 (395527X1)	30/6410-6 (391337X1)	30/6410-5 (391336X1)	78/9604-130 (3900613M2)
275, 285, 290, 298, 575, 590, 675, 690, 698, 698T, 699, 1004, 1004T	Cat. 2 Cat. 2.5				
168, 188 (Pont type 1972 type axle) 275, 285, 298, 575, 590, 592, 595, 698, 1080	Cat. 3	30/6408-31 (2714105M1) 140x160x13	30/6410-2 (1442255X1)	30/6410-6 (391337X1)	
2620, 2625, 2640, 2645, 2680, 2685, 2720, 2725 3610, 3630, 3650 (Angle de rotation 40° turning angle)	Cat. 3	30/6408-4 (395521X1)	30/6410-1 (1442254X1)	30/6410-2 (1442255X1)	

Planétaire / Planetary drive

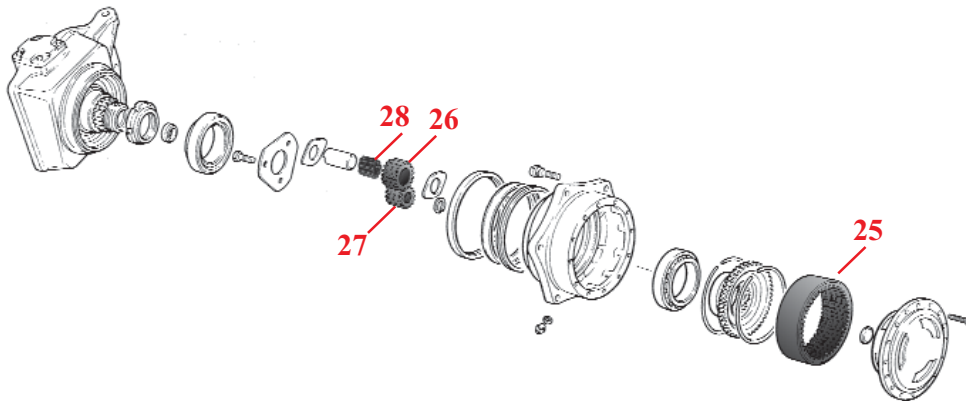

Fig.	Pont Axle	25 Pignon annulaire Annular gear	26 Planétaire Planetary gear	27 Pignon central Sun gear	28 Roul. à aiguilles Needle roller
Ponts NG Axles					
390, 390T, 396, 3055, 3060, 3065	Cat. 2	30/6430-1 (3426870M2)	30/6431-1 (3426730M1)	30/6432-2 (3426639M1)	5x 23.8m 30/6433-1 (3426852M3) 5x 34.8m 30/6433-2 (3426853M3)

Les références des pièces sont indicatives.
Nos pièces ne sont pas d'origine

Part numbers are quoted for reference purposes only.
Our parts and accessories are not original.



**PONT AVANT 4RM
4 WD FRONT AXLE**

Différentiel / Differential

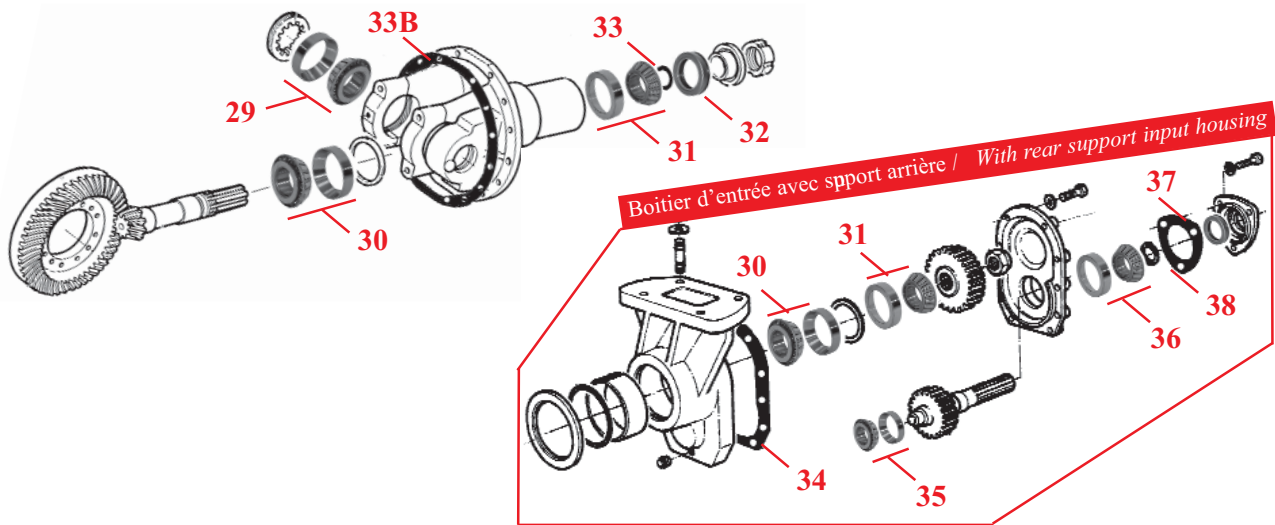

Fig.		29	30	31	32	33	33B
Tracteurs Tractors	Pont Axle	Roul. diff. Diff. bearing	Roul. avant Front bear.	Roul. arr. Rear bear.	Bague Oil seal	O-ring 'O' Ring	Joint Gasket
Ponts Landini Axles							
250, 265	Cat. 1	30/352-12 (330375X1)	30/353-11 (390876X1)	30/354-18 (1820418M1)	30/355-5 (392101X1)	30/6444-3 (364777X1)	30/6421-1 (1823574M1)
275, 285, 290 (France) 575, 590 675, 690 (⇒ 1984 Cat. 2)	Cat. 2			30/354-19 (1440636X1)	Voir infra : Boîtier d'entrée avec support arrière See below : Rear support input housing		
275, 290, 298 (UK) 675, 690 (⇒ 1984 Cat. 2A) 675, 690 (1984 ⇒ Cat. 2) 698, 698T, 699, 1004, 1004T	Cat. 2 Cat. 2.5		30/353-13 (1440826X1)	30/354-7 (1442253X1)			
168, 188 (Pont type 1972 type axle) 275, 285, 298, 575, 590, 592, 595, 698, 1080	Cat. 3		30/352-13 (1440651X1)	30/353-12 (3304822M91)	30/354-19 (1440636X1)		
2620, 2625, 2640, 2645, 2680, 2685, 2720, 2725 3610, 3630, 3650 (Angle de rotation 40° turning angle)	Cat. 3	30/352-14 (3540153M91)	30/353-7 (1442550X1)	30/354-1 (1850090M92)	30/355-7 (392756X1)	30/6444-4 (1007242M1)	

Boîtier d'entrée avec support arrière / With rear support input housing

Fig.		34	35	36	37	38
Tracteurs Tractors	Pont Axle	Joint Cover gasket	Roul. avant Front bear.	Roul. arr. Rear bear.	Bague Oil seal	Joint Gasket
Ponts Landini Axles						
275, 285, 290 (France) 575, 590 675, 690 (⇒ 1984 Cat. 2)	Cat. 2	30/6443-1 (1659783M2)	30/6440-2 (392084X1)	30/6441-1 (339818X1)	30/6407-1 (392107X1)	30/6442-1 (1659785M1)
275, 290, 298 (UK) 675, 690 (⇒ 1984 Cat. 2A) 675, 690 (1984 ⇒ Cat. 2) 698, 698T, 699, 1004, 1004T	Cat. 2 Cat. 2.5		30/6440-3 (1440627X1)	30/6441-2 (339856X1)	30/6407-4 (392108X1)	30/6444-2 (392022X1)
168, 188 (Pont type 1972 type axle) 275, 285, 298, 575, 590, 592, 595, 698, 1080	Cat. 3	30/6443-2 (2714073M1)	30/354-21 (1440637X1)		30/355-12 (2714076M1)	

Les références des pièces sont indicatives.
Nos pièces ne sont pas d'origine

Part numbers are quoted for reference purposes only.
Our parts and accessories are not original.



"THE RELIABLE SERVICE"



**PONT AVANT 4RM
4 WD FRONT AXLE**

Différentiel / Differential

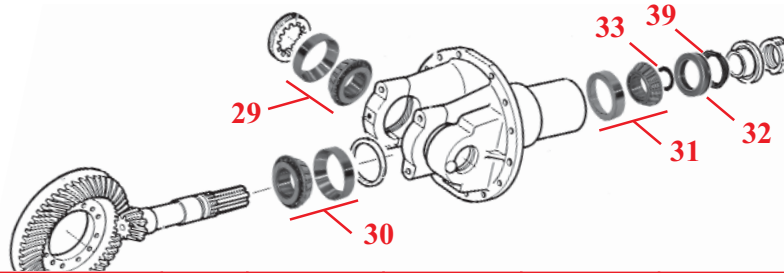

Fig.	29	30	31	32	39	33	
Tracteurs Tractors	Pont Axle	Roul. diff. Diff. bearing	Roul. avant Front bear.	Roul. arr. Rear bear.	Bague Oil seal	Bague Wiper seal	O-ring 'O' Ring
Ponts NG Axles							
340, 350, 355, 360, 362, 365, 375, 390, 390T, 396, 3050, 3060, 3065	Cat. 1 Cat. 2	1er / Early 30/352-15 (3009853X1)	30/353-5 (1440642X1)	30/354-9 (339481X1)	1er / Early 30/355-1 (3019967X1) 55x82x9.2	1er / Early 30/356-1 (3019969X1)	30/6444-5 (366434X1)
398, 399, 3070, 3075, 3080, 3085, 3090, 3095, 3115, 3120, 3120T	Cat. 2.5	Dernier &td Late & Std. 30/352-16 (391339X1)	30/353-6 (1441250X1, 3765690M1)	30/354-8 (339394X1)	Dernier/ Late 30/355-6 (3428942M1) 55x82x16.5		
3125, 3140 3610, 3630, 3650 (Angl. de rotation 50° turning angle) 3635, 3645, 3655, 3660, 3670, 3680, 3690	Cat. 3 Cat. 3.5 Cat. 3.6	30/352-16 (391339X1)	1er / Early 30/353-14 (3019932X1) Dernier/ Late 30/353-12 (3304822M91)	30/354-6 (1440635X1)	1er / Early 30/355-8 (3019968X1) 65x92x11.2 Dernier/ Late 30/355-9 (3428314M1) 65x92x18	1er / Early 30/356-2 (3019970X1)	
Ponts AG Axles							
240, 253, 263, 342, 352, 362, 362N, 372N, 382N	AG65 AG66	Std. 30/352-17 (3001884X1) Hydrobck . 30/352-15 (3009853X1)	30/6451-17 (3426619M1)	30/6410-20 (3310930M1)	30/355-10 (3428259M1)		30/6444-3 (364777X1)
4215, 4220, 4225, 4235, 4245, 4315, 4320, 4325, 4335, 4345	AG66	30/352-15 (3009853X1)	30/353-15 (3764543M1)	30/354-20 (3764544M1)			
275, 290, 365, 375, 390, 390T, 396, 3050, 3060, 3065, 4225, 4235, 4245, 4255, 4260, 4265, 4325, 4335, 4345, 4355, 4360, 6110, 6120, 6130, 6140, 6235, 6245	AG75 AG85	30/352-16 (391339X1)	30/353-5 (1440642X1)	30/354-9 (339481X1)	30/355-6 (3428942M1)		30/6444-5 (366434X1)
398, 399	AG105		30/353-6 (1441250X1, 3765690M1)	30/354-21 (1440637X1)			
3075, 3085, 3095, 3120, 4240, 4245, 4255, 4260, 4265, 4270, 4345, 4355, 4360, 4365, 4370, 6150, 6160, 6170, 6180, 6255, 6260, 6265	AG105 AG105L AG125			30/354-8 (339394X1)			
3635, 3645, 3655, 8110, 8120, 8130, 8140	AG155		30/353-12 (3304822M91)	30/354-6 (1440635X1)			
6190, 6290, 8210, 8220, 8240	AG155 AG155H		30/353-16 (3429676M1)	30/354-22 (3764160M1)			
3670, 3690, 8150, 8160, 8240, 8250, 8260	AG200 AG200H		30/353-17 (3764266M1)	⇒ D355010 30/354-23 (1440648X1) D355011 ⇒ 30/354-24 (3764593M1)	30/355-9 (3428314M1)		

Les références des pièces sont indicatives.
Nos pièces ne sont pas d'origine

Part numbers are quoted for reference purposes only.
Our parts and accessories are not original.



**PONT AVANT 4RM
4 WD FRONT AXLE**

Couronnes & pignons / Crown wheel & pinions

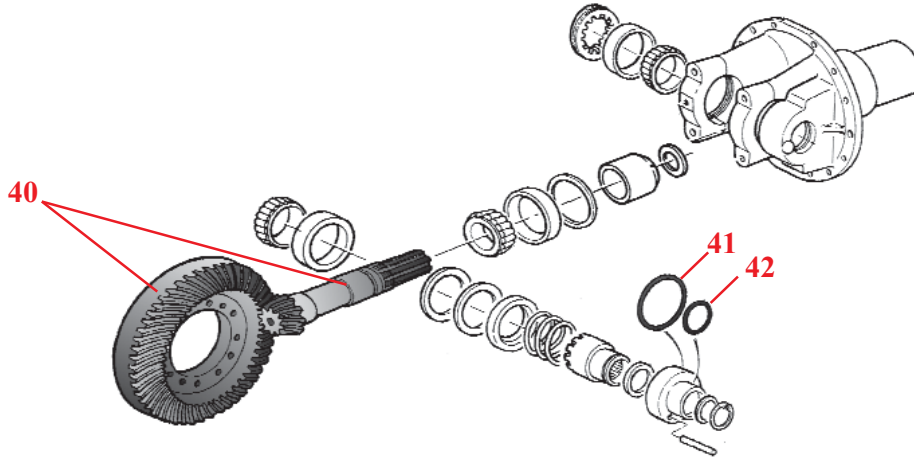

Fig.		40	41	42
Tracteurs Tractors	Pont Axle	Couronne & pignon Crown wheel & pinion	Grand O-ring Large 'O' ring	Petit O-ring Small 'O' ring
Ponts NG Axles				
340, 350, 355, 360 (Différentiel standard / <i>Standard differential</i>)	Cat. 1 Cat. 2	9x31 30/341-25 (3427107M91)		
350, 355, 360, 362, 365, 375, 390 (Différentiel autobloc <i>No-spin differential</i>) Pont / Axle 0997 ⇒				
350, 355, 360, 362, 365, 375, 390, 390T, 396 (Différentiel autobloc <i>Hydrolock differential</i>)			30/6340-1 (359236X1)	30/6341-1 (3019927X1)
398, 399 (Différentiel autobloc <i>Hydrolock differential</i>)	Cat. 2.5			
3050 (V293040 ⇒), 3060 (V266035 ⇒), 3065 (Différentiel autobloc <i>Hydrolock differential</i>)	Cat. 1 Cat. 2	9x33 30/341-24 (3427104M91)		
3070, 3080, 3090 (⇒ V272018) (Différentiel autobloc <i>No-spin differential</i>)	Cat. 2.5	11x45 30/341-8 (3427161M91)		
3070, 3080, 3090 (V272019 ⇒) 3075, 3085, 3095, 3115, 3120, 3120T (Différentiel autobloc <i>Hydrolock differential</i>)			11x45 30/341-26 (3427113M91)	30/6340-1 (359236X1)
3125, 3140 3610, 3630, 3650 (Angle de rotation 50° <i>turning angle</i>) 3635, 3645, 3655, 3660, 3670, 3680, 3690	Cat. 3 Cat. 3.5 Cat. 3.6			
Ponts AG Axles				
365, 375, 390, 390T, 396, 398, 399, 3050, 3060, 3065, 3075, 3085, 4225, 4235, 4240, 4245, 4255, 4260, 4265, 4270, 4325, 4335, 4345, 4355, 4360, 4365, 4370, 6110, 6120, 6130, 6140, 6150, 6160, 6235, 6245, 6255, 6260, 6265	AG75 AG85 AG105 AG105L		30/6340-1 (359236X1)	30/6341-1 (3019927X1)
3095, 3120, 3635, 3645, 3655, 3670, 3690, 6170, 6180, 6190, 6270, 6280, 6290, 8110, 8120, 8130, 8140, 8150, 8160	AG125 AG155 AG200			
8210, 8220, 8240, 8250, 8260	AG155H AG200H			

Les références des pièces sont indicatives.
Nos pièces ne sont pas d'origine

Part numbers are quoted for reference purposes only.
Our parts and accessories are not original.



**PONT AVANT 4RM
4 WD FRONT AXLE**

Arbre de transmission / Transmission shaft

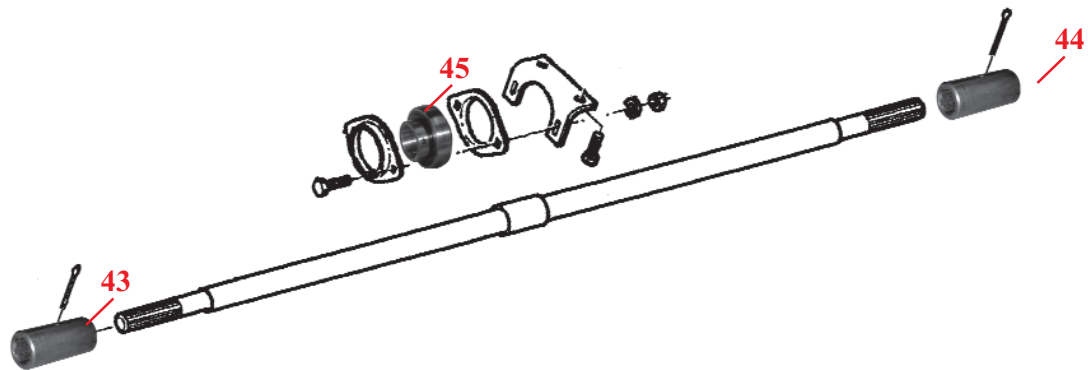

Fig.	43	44	45
Tracteurs Tractors	Manchon d'accoupl. / Coupling sleeve		Roulement. Bearing
	Avant / Front	Arr. / Rear	
165, 168, 178, 188 275, 285 (France) 575, 590, 592, 595, 1080	4.40"x 1 3/8" 6 cannettes / splines 30/6492-1 (3380056M2)		30/6418-7 (1722011M1)
290, 298 (France) 675, 690 (⇒ 1984) 698, 1004	1er / Early - 4.40"x 1 3/8" 6 cannettes / splines 30/6492-1 (3380056M2)	Demier / Late - 4.75"x 1 3/8" 6 cannettes / splines 30/6492-2 (1683341M2)	
275, 290, 298 (UK) 675, 690 (1984 ⇒) 698T, 699, 1004T	4.75"x 1 3/8" 6 cannettes / splines 30/6492-2 (1683341M2)		30/6418-2 (3386985M1)
2620, 2625, 2640, 2645, 2680, 2685, 2720, 2725	4.40"x 1 3/8" 6 cannettes / splines 30/6492-1 (3380056M2)		1er / Early 30/6418-7 (1722011M1) Demier / Late 30/6418-2 (3386985M1)
3050, 3060, 3065, 6110, 6120, 6130, 6140, 6235, 6245 6255 Nez/bngeant / Steep nose	4.75"x 1 1/8" 6 cannettes / splines 30/6492-3 (3384857M2)	4.40"x 1 3/8" 6 cannettes / splines 30/6492-1 (3380056M2)	30/6418-2 (3386985M1)
3070, 3075, 3080, 3085, 3090, 3095, 3115, 3120, 3120T, 3125, 3140, 3610, 3630, 3650, 3660, 6150, 6160, 6170, 6180, 6255, 6260, 6265, 6270, 6280	4.40"x 1 3/8" 6 cannettes / splines 30/6492-1 (3380056M2)		Normal / Normal 30/6418-2 (3386985M1) Renforcé / Heavy duty 30/6418-5 (3712873M1)
3635, 3645, 3655, 3670, 3680, 3690 Arbes Cat. 3, Cat 3.5, Cat 3.6 Axles	4.40"x 1 3/8" 6 cannettes / splines Cobrette / Flanged 30/6492-9 (3712470M1)	4.40"x 1 3/8" 6 cannettes / splines 30/6492-1 (3380056M2)	
3635, 3645, 3655 (AG155 (⇒ D089018)) 3670, 3690 (AG155 (⇒ D163034))	4.40"x 1 1/2" 24 cannettes / splines 30/6492-6 (3714416M2)		30/6418-5 (3712873M1)
3635, 3645, 3655 (AG155 (D089019 ⇒)) 3670, 3690 (AG155 (D163035 ⇒)) 8110, 8120, 8130, 8140, 8150, 8160, 8210, 8220, 8240 (AG155H)	4.40"x 1 1/2" 24 cannettes / splines 30/6492-6 (3714416M2)		30/6418-2 (3386985M1)
6190, 6290	4.40"x 1 1/2" 24 cannettes / splines 30/6492-6 (3714416M2)		30/6418-5 (3712873M1)
8170, 8180, 8240 (AG200H), 8250, 8260, 8270, 8280	4.40"x 1 1/2" 24 cannettes / splines 30/6492-6 (3714416M2)		30/6418-5 (3712873M1)

Les références des pièces sont indicatives.
Nos pièces ne sont pas d'origine

Part numbers are quoted for reference purposes only.
Our parts and accessories are not original.



**PONT AVANT 4RM
4 WD FRONT AXLE**

Arbre de transmission / Transmission shaft

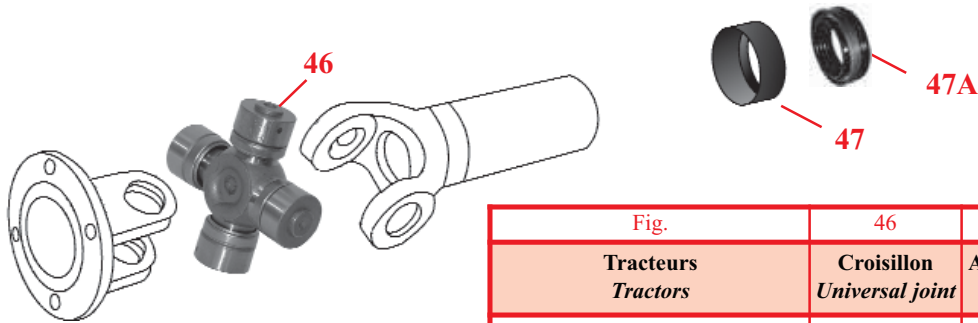

Fig.	46	47	47A
Tracteurs Tractors	Croisillon Universal joint	Anti-poussière Dust cap	Bague Seal
240, 265 (Pont Schndër Axle)	30/6403-49 (1895359M1) 27x85		
250, 265 (Pont Landini Axle)			
240, 275, 290 (Pont AG Axle) 253, 263, 340, 342, 350, 352, 355, 360, 362, 362N, 372N, 375, 382N, 390, 390T, 396, 398, 399	30/6403-5 (1895699M1, 3475808M1) 27x81.7	30/6427-1 (3475909M2)	30/6427-2 (3699802M2)

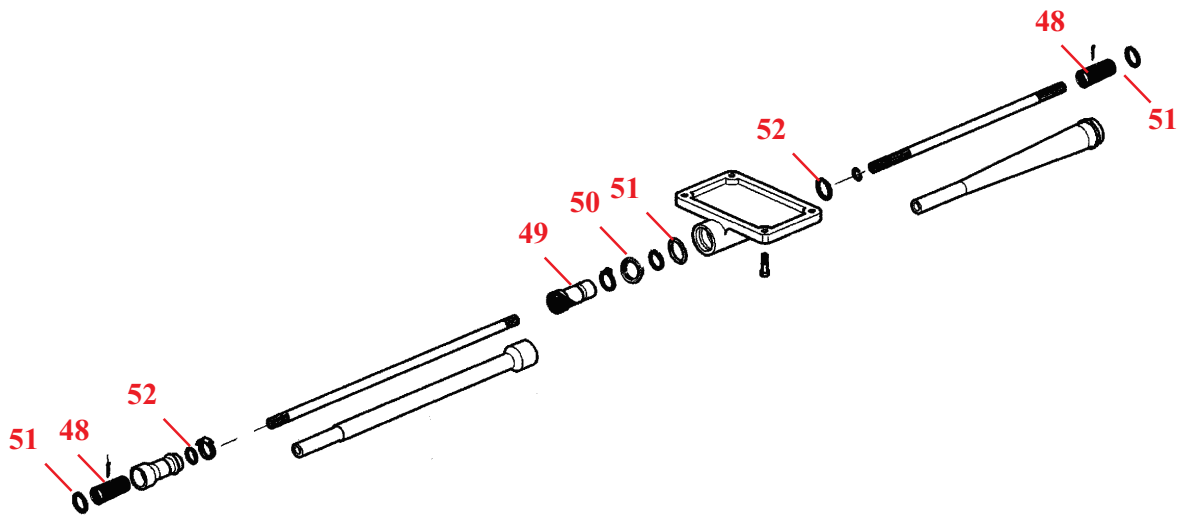

Fig.	48	49	50	51	52
Tracteurs Tractors	Manchon d'accouplement / Coupling sleeve		Roulement Bearing	O-ring 'O' Ring	O-ring 'O' Ring
	Avt & arr. / Front & rear	Centre / Centre			
4215, 4220, 4225, 4235, 4240, 4245, 4255, 4260, 4265, 4270, 4315, 4320, 4325, 4335, 4345, 4355, 4360, 4365, 4370	3.15" x 1 1/4" 20 cannettes / splines 30/6492-7 (3800250M1)	2.72" x 1 1/4" 20 cannettes / splines 30/6492-8 (3800251M1)	30/6418-6 (3808847M1)	30/6423-1 (3000440X1)	30/6423-2 (3005537X1)

Les références des pièces sont indicatives.
Nos pièces ne sont pas d'origine

Part numbers are quoted for reference purposes only.
Our parts and accessories are not original.



**BOITE DE TRANFERT
TRANSFER GEARBOX**

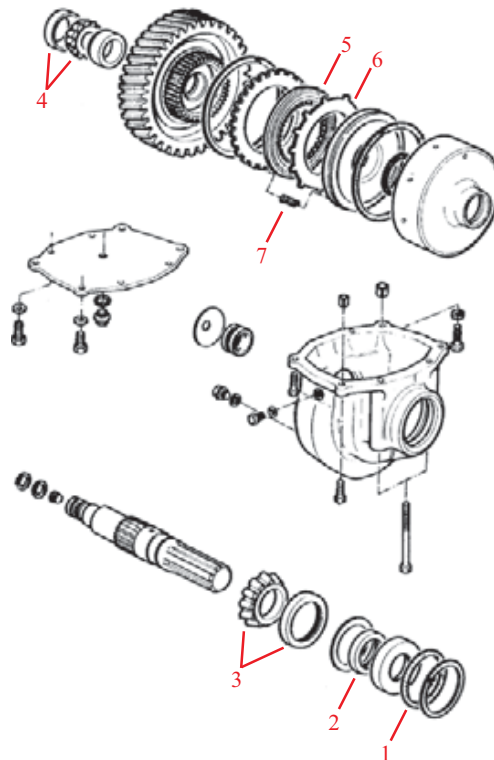

Fig.	1	2	3	4
Tracteurs Tractors	Joint torique "O" Ring	Bouillage Oil seal	Roulement avant Front bearing	Roulement arrière Rear bearing
2620, 2625, 2640, 2645, 2680, 2685, 2720, 2725	30/6444-1 (3000607X1)	30/355-7 (392756X1)	30/354-8 (339394X1)	30/6440-1 (1644435M91)

Tracteurs Tractors	Fig.	Réf. Ref.	OEM	Description
165 MKIII, 168, 178, 188, 275, 285, 290, 298, 575, 590, 592, 595, 675, 690, 698, 698T, 1004, 1004T, 1080, 2620, 2625, 2640, 2645, 2680, 2685, 2720, 2725	5	30/317-1	1672626M1	Disq de friction Friction disc
275 (UK), 290 (UK), 698T, 1004T 675, 690 (1984 ⇒) 2620, 2640, 2680 (271213 ⇒) 2625, 2645, 2685, 2720, 2725	6	30/315-1	185464M1	Disq intermédiaire Intermediate disc
165 MKIII, 168, 178, 188, 275, 285, 290, 298, 575, 590, 592, 595, 675, 690, 698, 698T, 1004, 1004T, 1080, 2620, 2625, 2640, 2645, 2680, 2685, 2720, 2725	7	30/314-1	186519M1	Ressort Spring

**RESERVOIR DE CIRCUIT HYDRAULIQUE DE DIRECTION
HYDRAULIC STEERING TANK**

30/573-1
(3530018M92)

Séries 100, 200 & 300 italiennes
100, 200 & 300 italian series
1014, 1024



Les références des pièces sont indicatives.
Nos pièces ne sont pas d'origine

Part numbers are quoted for reference purposes only.
Our parts and accessories are not original.



POMPES DE DIRECTION
STEERING PUMPS

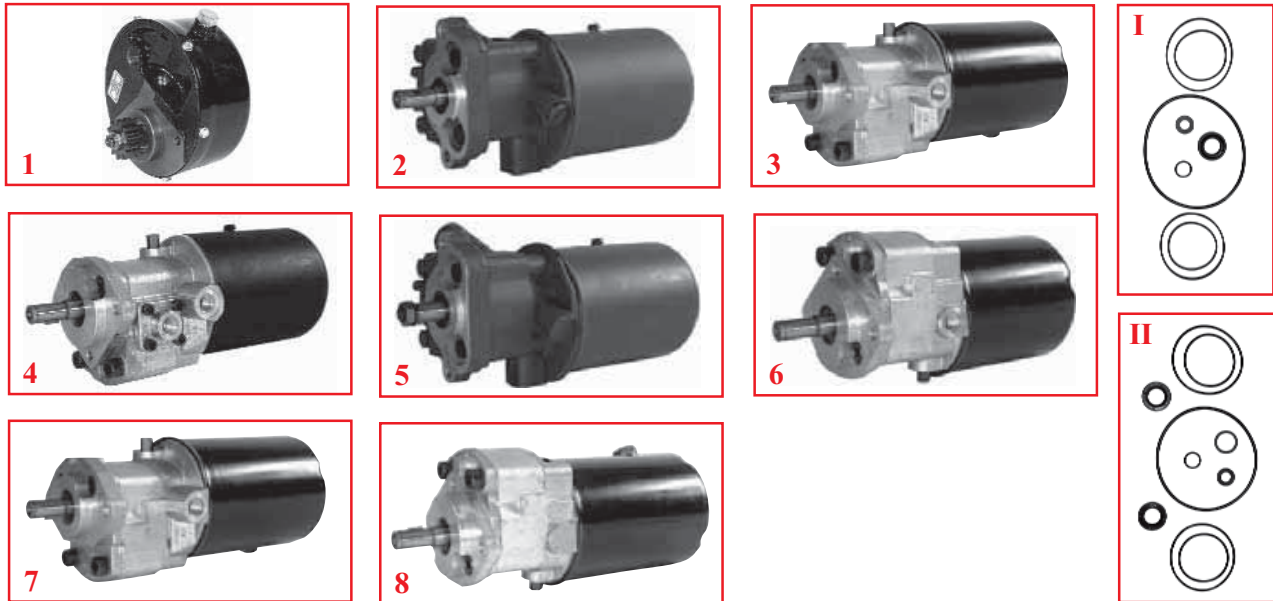

Tracteurs Tractors	Fig.	Pompes Pumps	OEM	Remarque Observation	Jeu de joints Seal kit
135, 148, 230, 240, 250, 550 20B, 20D, 20E, 30E, 30H, 40	1	30/570-2	773126M92		30/575-1 (1810529M91)
158MKIII, 260, 560	8	30/570-11	3600189M91	Fixation 3 gojns 3 bolts fitting	30/575-4 (1635948M92)
165, 168, 175, 178, 185, 188, 265, 275, 285, 290, 565, 575, 590 Montage Pesseÿ fitting 30D, 50, 50B, 50BMKII	2	30/570-1	897146M94	Fixation 2 gojns avec pignon 2 bolts fitting with gear	30/575-2 (I) (1810417M91) Pon/ For 897146M92&93
		30/570-1E (A) Econom		Fixation 2 gojns avec pignon 2 bolts fitting with gear	ou or 30/575-3 (II) (1810618M92) Pon/ For 897146M94
		30/570-1B	897159M2	Pignon Gear	
165, 168, 175, 178, 185, 188, 265, 275, 285, 290, 565, 575, 590, 675, 690 Montage 'Air Eipant' fitting	3	30/570-5	3774649M91	Fixation 2 gojns 2 bolts fitting	30/575-4 (1635948M92)
265, 275, 285, 290, 675, 690 4RM / 4WD	3	30/570-6	3774618M91	Fixation 2 gojns 2 bolts fitting	30/575-4 (1635948M92)
275E, 290E, 362, 365, 375, 375E, 390, 390E					30/575-6 (1810839M92)
298, 698, 1004	4	30/570-7	3904627M91	Fixation 3 gojns 3 bolts fitting	30/575-4 (1635948M92)
362, 365, 375, 390	5	30/570-14	3774616M92	Fixation 2 gojns 2 bolts fitting	
592, 595MKI	6	30/570-8	1808294M2	Fixation 3 gojns 3 bolts fitting	30/575-4 (1635948M92)
592, 595MKII	7	30/570-9	1671174M93		

(A) Kit de réparation pon 30/570-1E : commandez 30/575-16

(A) Seal kit for 30/570-1E : please order 30/575-16



Consultez aussi la section filtration ! / Please see filters section !



Les références des pièces sont indicatives.
Nos pièces ne sont pas d'origine

Part numbers are quoted for reference purposes only.
Our parts and accessories are not original.



POMPES HYDRAULIQUES
HYDRAULIC PUMPS

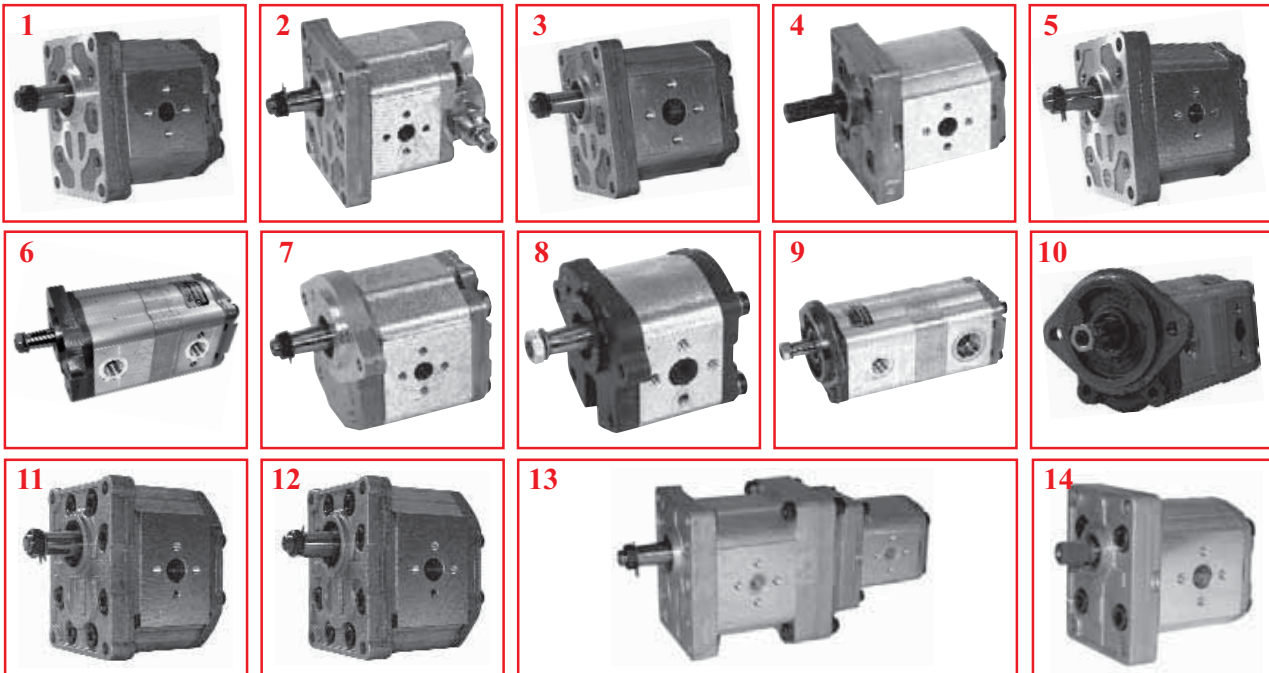

Tracteurs Tractors	Fig.	Réf. Ref.	OEM	Remarque Observation
134, 154, 164T, 233, 234, 253, 254, 263, 264, 333, 363	1	30/566-60	3539858M91	Revège - Rotation gauch Lift - LH rotation
154, 174, 184, 194	2	30/566-113	3540970M91	Direction - Avec sopape Steering - With valve
154F, 154S, 164S, 174F, 174S, 184F, 184S, 194F, 194S, 274C	3	30/640-30	3539859M91	Revège - Rotation gauch Lift - LH rotation
174, 184, 194, 233, 253, 254, 263, 264, 273, 274, 283, 284, 293, 294, 333, 353, 363, 373, 377, 383, 387, 393, 397, 1007, 1014, 1024, 1114, 1134	1	30/566-60	3539858M91	Direction - Rotation gauch Steering - LH rotation
174F, 174S, 184F, 184S, 194F	4	30/566-6	3300930M91	Direction - Steering
174, 184, 194, 273, 274, 283, 284, 293, 294 373, 383, 393 (⇒ P06076) 377, 387, 397 (⇒ P04064)	5	30/566-61	3539857M91	Revège - Rotation droite Lift - RH rotation
174F, 184F, 194F, 362, 372N, 374S, 374F, 382, 384S, 394S 365, 375, 390, 398 (B18009 ⇒)	6	30/565-1	3774612M91	Direction + pompe auxiliaire 10+8cc Steering + auxiliary pump 10+8cc
334V, 353, 354, 363, 364, 366	7	30/565-48	3534387M91	Revège - Rotation droite - 11cc Lift - RH rotation - 11cc
367CF, 374, 384, 394, 1007 373, 383, 393 (P06077 ⇒) 377, 387, 397 (P04065 ⇒)	8	30/565-52	3534941M91	Revège - Rotation gauch - 11cc Lift - LH rotation - 11cc
399 (Moten/ Engine A6.354.4)	9	30/565-2	3597420M91	Direction + pompe auxiliaire Steering + auxiliary pump
396, 399 (Moten/ Engine 1006.6)	10	30/565-9	3774613M91	Direction + pompe auxiliaire Steering + auxiliary pump
294, 394, 1014, 1024	11	30/640-31	3549613M91	Revège - Groupe III - 22cc Lift - Group III - 22cc
1114, 1134	12	30/640-29	3549614M91	Revège - Groupe III - 26.5cc Lift - Group III - 26.5cc
1114, 1134	4	30/566-6	3300930M91	Bbcage du différentiel Differential lock
1014, 1024	13	30/566-222	3302501M92	Direction + Bbcage du différentiel Steering + Differential lock
1014, 1024, 1114, 1134	14	30/566-5	3310317M91	Bbcage du différentiel Differential lock



Les références des pièces sont indicatives.
Nos pièces ne sont pas d'origine

Part numbers are quoted for reference purposes only.
Our parts and accessories are not original.

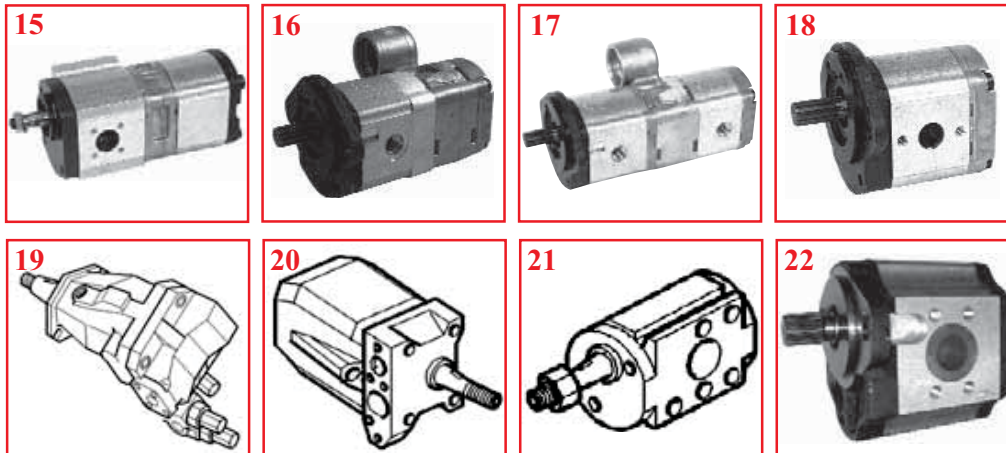

POMPES HYDRAULIQUES
HYDRAULIC PUMPS



Tracteurs Tractors	Fig.	Réf. Ref.	OEM	Remarque Observation
3050, 3060, 3065, 3070, 3075, 3080, 3085, 3090, 3095, 3115, 3120, 3125, 6110, 6120, 6130, 6140, 6150, 6160, 6170, 6180, 6190, 6235, 6245, 6255, 6260, 6265, 6270, 6280, 6290	15	30/565-75	3382280M1	Rebègue + Direction Lift + Steering
4225, 4235,, 4240, 4245, 4255, 4260, 4265, 4270	16	30/565-111	3816914M91	Direction - 10cc - 540/1000T PTO Steering - 10cc - PTO 540/1000T
4225, 4235, 4245, 4255, 4265, 4325, 4335, 4345, 4355, 4365		30/565-226	3816915M91	Direction - 18cc - 540T PTO Steering - 18cc - PTO 540T
4225, 4235, 4240, 4245, 4255, 4260, 4265, 4270, 4325, 4335, 4345, 4355, 4360	17	30/565-106	3816909M91	Direction + Rebègue - 14+10cc - 540/1000T PTO Steering + Lift - 14+10cc - PTO 540/1000T
4215, 4220, 4225, 4235, 4240, 4245, 4255, 4265, 4315, 4320, 4325, 4335, 4345, 4355, 4365		30/565-107	3816910M91	Direction + Rebègue - 18+14cc - 540/750T PTO Steering + Lift - 18+14cc - PTO 540/750T
		30/565-229	3816911M91	Direction + Rebègue - 22.5+18cc - 540T PTO Steering + Lift - 22.5+18cc - PTO 540T
4225, 4235, 4240, 4245, 4255, 4260, 4265, 4270, 4325, 4335, 4345, 4355, 4360, 4370	18	30/565-230	3816912M91	Auxiliaire Auxiliary
3635, 3645, 3655, 3670, 3690, 8110, 8120, 8130, 8140, 8150, 8160	19	30/640-47	3712289M3	Hydraul - Couercè droit - Load sensing - 45 cc Hydraulic - RH fit - Load sensing - 45cc
3635, 3645, 3655, 3670, 3690, 6110, 6120, 6130, 6140, 6150, 6160, 6170, 6180, 6190, 6235, 6245, 6255, 6270, 6280, 6290, 8110, 8120, 8130, 8140, 8150, 8160, 8170, 8180, 8220, 8240, 8260, 8270, 8280	21	30/640-48	3618001M3	Hydraul - Couercè gauche - Load sensing - 35cc ou 45cc Hydraulic - LH fit - Load sensing - 35cc or 45cc
6110, 6120, 6130, 6140, 6235, 6245	20	30/640-52	3790419M2	Hydraul - Couercè droit - Load sensing - 35cc Hydraulic - RH fit - Load sensing - 35cc
6150, 6160, 6170, 6180, 6190, 6255, 6270, 6280, 6290, 8170, 8180, 8220, 8240, 8260, 8270, 8280	20	30/640-53	3716370M3	Hydraul - Couercè droit - Load sensing - 45cc Hydraulic - RH fit - Load sensing - 45cc
 50B, 50D, 50H, 50HX	22	30/640-10	1470214M91	Rebègue / Lift
		30/640-10B	1456340M93	Axe Drive shaft 

Les références des pièces sont indicatives.
Nos pièces ne sont pas d'origine

Part numbers are quoted for reference purposes only.
Our parts and accessories are not original.



**DIRECTION ASSISTEE
POWER STEERING**

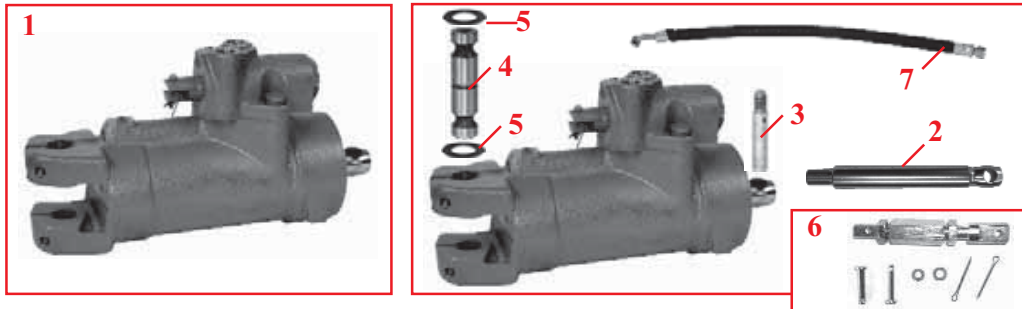

Tracteurs Tractors	Fig.	Réf. Ref.	OEM	Remarque Observation
165, 168, 175, 178, 185, 188, 265, 275, 285, 290, 375, 390	1	30/580-3	3186320M92	Vérin complet avec sopape 3186321M91 Complete cylinder with valve 3186321M91
	2	30/580-3A	1606882M3	Tige de vérin / Cylinder stem
		30/580-3B	3186321M91	Sopape / Valve
	3	30/576-1	898366M2	Axe / Shaft
	4	30/577-1	1671322M1	Axe / Shaft
	5	30/578-1	829258M1	Caè de réglage 0.076/0.127m Adjusting key 0.076/0.127mm
		30/578-2	829259M1	Caè de réglage 0.50/0.56m Adjusting key 0.50/0.56mm
	6	30/579-1	881727M1+ 188909M1 + 881729M1 + 881728M1 + 375108X1 + 353430X1	Jeude réparation / Repair kit
	7	30/586-1	897153M92	Flexib / Hose 620m



Tracteurs Tractors	Fig.	Réf. Ref.	OEM	Remarque Observation
135, 148, 230, 235, 240, 245, 250, 255	1	30/580-1	3401240M91	Vérin gauche / LH cylinder
		30/580-2	3401241M91	Vérin droit / RH cylinder
550, 560	1	30/580-1	3401240M91	Vérin droit / RH cylinder
		30/580-2	3401241M91	Vérin gauche / LH cylinder
240, 250, 265, 275, 290, 675, 690, 1014 4 roues motrices / 4WD	2	30/580-8	1748133M94	Vérin (Tige Ø25mm) Cylinder (Stem Ø25mm)

**DIRECTIONS ASSISTEES COMPLETES /
COMPLETE POWER STEERINGS**

30/6500-17 Kit complet d'adaptation pour montage sur
(1866890R98) Complete adaptable set for fitting on
165, 168, 175, 178, 185, 188

Pour d'autres applications, veuillez nous consulter
For other applications, please contact us

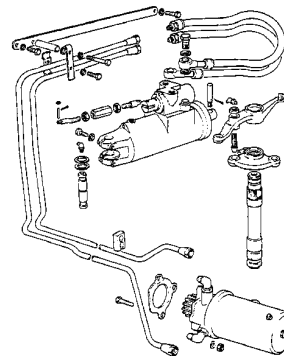

Les références des pièces sont indicatives.
Nos pièces ne sont pas d'origine

Part numbers are quoted for reference purposes only.
Our parts and accessories are not original.



KITS DE JOINTS DE VERINS DE DIRECTION - 2RM
MF 2WD STEERING CYLINDER SEAL KITS



Tracteurs Tractors	Réf. Ref.	OEM	Vérin de direction Steering cylinder
Tracteurs français, anglais / French, UK tractors			
135, 148, 230, 235, 240, 245, 250, 255, 260, 550, 560	30/585-1	3314663M91	30/580-1 (3401240M91) 30/580-2 (3401241M91)
165, 175, 178	30/585-2	1885710M91	Pon vérin Hydrosteer / For Hydrosteer cylinder (1884374M93)
165, 168, 175, 178, 185, 188, 265, 275, 285, 290	30/585-3	1810437M91	Pon vérin Laser / For Laser cylinder - (1853466M93)
165, 168, 175, 178, 185, 188, 265, 275, 275E, 285, 290, 290E, 375E, 390E, 565, 575, 590, 675, 690	30/585-4	1606890M91	Pon vérin de dir. assistée / For power steering cyl. 30/580-3 (3186320M91)
			Pon vérin hydrostatique / For hydrostatic cylinder (1605121M92)
	30/585-18	3904110M91	Pon vérin de direction assistée For power assisted cylinder (3773740M91) Pon vérin de dir. assistée / For power steering cyl. (3773711M91)
230, 240, 243, 253, 263, 340, 342, 350, 352, 355, 360, 362, 362N, 372N, 4215, 4220	30/585-19	3404477M91	Pon vérin Pacoma / For Pacoma cylinder (3401553M92)
230, 240, 243, 253, 263, 340, 342, 350, 352, 355, 360, 362, 362N, 372N, 4215, 4220, 4315, 4320	30/585-20	3904170M92	Pon vérin KMF / For KMF cylinder (3773716M91)
365, 375, 390, 390T, 396, 398, 399	30/585-5	3443433M93	
3050, 3060, 3065, 3070, 3075, 6110, 6120, 6130, 6140, 6150	30/585-21	3484685M91	Pon vérin Pacoma 57 mm 6 trous non renforcé For Pacoma 57 mm cylinder - 6 hole normal duty (3483180M92)
	30/585-22	3900289M91	Pon vérin Sima 57 mm 6 trous non renforcé For Sima 57 mm cylinder - 6 hole normal duty (3617722M1)
3070, 3080, 3090, 3095, 3115, 3125, 3610, 3630, 3645, 3650, 3655, 3670, 3680, 3690, 6150, 6160, 6170, 6180, 6190, 6235, 6245, 6255, 6260, 6265, 6270, 6280, 6290, 8110, 8120, 8130, 8140, 8150, 8160, 8210, 8220, 8240	30/585-5	3443433M93	Pon vérin Pacoma 68 mm 8 trous renforcé For Pacoma 68 mm cylinder - 8 hole heavy duty (3483098M92)
3070, 3075, 3080, 3085, 3095, 3115, 3120, 3125, 3635, 3645, 3655, 3670, 3680, 3690, 6150, 6160, 6170, 6180, 6190, 8110, 8120, 8130, 8140, 8150, 8160	30/585-23	3900287M91	Pon vérin Sima 68 mm 8 trous renforcé For Sima 68 mm cylinder - 8 hole heavy duty (3617723M1)

Les références des pièces sont indicatives.
Nos pièces ne sont pas d'origine

Part numbers are quoted for reference purposes only.
Our parts and accessories are not original.



KITS DE JOINTS DE VERINS DE DIRECTION - 2RM
MF 2WD STEERING CYLINDER SEAL KITS

Tracteurs Tractors	Réf. Ref.	OEM	Vérin de direction Steering cylinder
Tracteurs français, anglais / French, UK tractors			
4225, 4235, 4240, 4245, 4255, 4260, 4265, 4270	30/585-5	3443433M93	Pon vérin Pacoma / For Pacoma cylinder Ø8 m (3622607M92)
4225, 4235, 4240, 4245, 4255, 4260, 4265, 4270, 4325, 4335, 4345, 4355, 4360, 4365, 4370	30/585-24	3904124M91	Pon vérin KMF / For KMF cylinder Ø8 m (3773718M91, 3817199M92)
Tracteurs italiens / Italian tractors			
134V, 154V, 164TV, 174V, 334V 354, 364, 374, 384 modèles V & Q <i>models</i>	30/585-25	3484582M91	Pon vérin / For cylinder (3309142M91, 3483345M91)
154 F/S, 164T F/S, 174, 174 F/S, 184, 184 F/S, 194, 194 F/S, 233, 253, 254, 254S, 263T, 264T, 264TS, 273, 274, 274 S/SK, 283, 284, 284S, 293, 294, 294S, 333, 353, 353 LX/S, 363, 363 LX/S, 373, 373 LX/S, 377, 383 LX/S, 387, 393, 393 LX/S/TLX, 397, 397T, 1007, 354, 364, 374, 384, 394, 3210, 3220, 3225, 3235 modèles AP/AQ/FP/FG/E/H <i>models</i>	30/585-26	1609086M91	Pon vérin For cylinder (1605172M91, 3186427M91, 3401131M91, 3401645M91)
154S, 164TS, 174S, 184S, 194S 354, 364, 374, 384, 394, 3210, 3220, 3225, 3235 modèles GE/S/SP/SQ <i>models</i>	30/585-27	3540401M91	Pon vérin For cylinder (3401254M91, 3304040K91)

JEUX DE JOINTS DE VERINS POUR TRACTEURS INDUSTRIELS
LOADER & BACKHOE RAM SEAL KITS

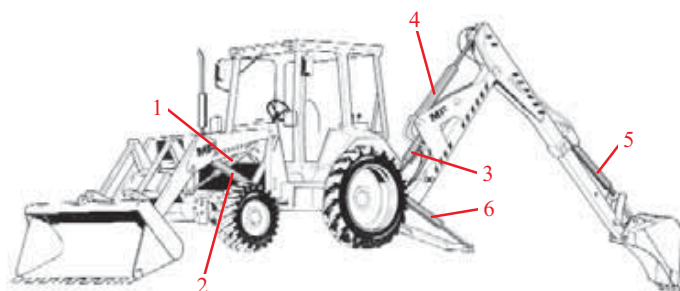

Fig.	1	2	3	4	5	6
Tracteurs Tractors	Levage Lift	Cavage bac Bucket tilt	Flèche Boom	Balancier Dipperstick	Cavage godet Bucket	Stabilisateur Stabiliser
50B (Cessna Ram)	30/801-1 (1810252M92)	30/802-1 (1810056M92)	30/804-1 (1810293M91)	30/805-1 (1810496M91)	30/807-1 (1810052M91)	30/808-1 (1810054M91)
50B, 50E, 50EX	30/801-2 (1606583M93)	30/802-2 (1606502M94)	30/804-2 (1607427M91)	30/805-2 (1607721M91)	30/807-2 (1606737M93)	30/808-2 (1606532M94)
50B MKII, 50D, 50E, 50EX, 50F, 50H, 50HX, 60H				30/805-3 (1608904M91)	30/807-3 (3187412M91)	



Les références des pièces sont indicatives.
Nos pièces ne sont pas d'origine



Part numbers are quoted for reference purposes only.
Our parts and accessories are not original.



COUPLEURS HYDRAULIQUES
HYDRAULIC COUPLING

Tracteurs Tractors	Fig.	Coupleur Coupling	OEM	Kit de joint Seal kit
3635, 3645, 3655, 3670, 3690, 8110, 8120, 8130, 8140, 8150, 8160		30/908-3 Droit / RH	3902107M92	30/909-4
		30/908-4 Gauch / LH	3902108M92	
240, 253, 263, 275E, 290E, 340, 342, 350, 352, 355, 360, 362 /N, 365, 372N, 375 /E, 382N, 390 /E/T, 396, 398, 399, 3050, 3060, 3065, 3070, 3075, 3080, 3085, 3090, 3095, 3120, 3125, 3635, 3645, 3655, 3670, 3690, 8110, 8120, 8130, 8140, 8150, 8160		30/908-5	3794298M1	30/909-5
Séries 4200, 4300, 6100, 6200 series				

Type	Fig.	Coupleur Coupling	Partie male Male half	Partie femelle Female half	Capuchon Dust cap
Doty		69/900-1 (B2000)	69/901-1 (646670M91)	69/902-1 (646663M91)	69/903-1 (646669M1)
Exactor		69/900-2 (B2001)	69/901-2 (1884291M91)	69/902-2 (1884290M91)	69/903-2 (817630M1)

Type	Fig.	Partie male Q/R Male	Partie femelle Q/R Female	Fig.	Freins de remorque Trailer brakes	
					Male / Male	Femelle / Female
1/2" BSP		69/905-1 (3406706M1)	69/906-1 (3406707M1)			
3/4" JIC		69/905-2 (1684473M1)	69/906-3 (1680263M1)		69/907-1 (909024M1)	69/908-1 (958826M1)

Les références des pièces sont indicatives.
Nos pièces ne sont pas d'origine

Part numbers are quoted for reference purposes only.
Our parts and accessories are not original.



POMPES DE RELEVAGE HYDRAULIQUES INTERNES
INTERNAL HYDRAULIC LIFT PUMPS

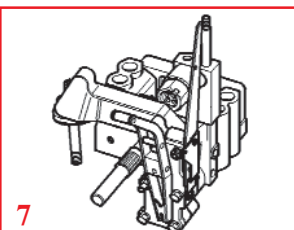
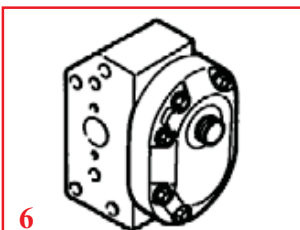
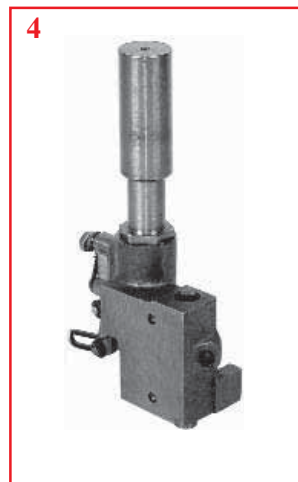
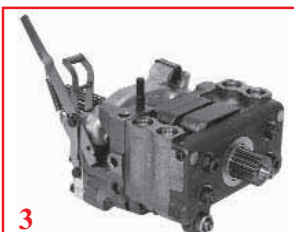

Tracteurs Tractors	Fig.	Réf. Ref.	OEM	Remarque Observation
35, 65, 765, 865	1	30/600-1	184473M93	Axe / Shaft 10Z
135, 148, 165, 175, 178	2	30/600-3	1684582M92	Axe / Shaft 10Z
148, 152, 158, 165, 168, 185, 188, 230, 231, 240, 245, 250, 253, 255, 260, 263, 265, 275, 290, 298, 340, 550, 560, 565, 575, 590, 675, 690, 698, 699, 1004, 1200, 1250  20B, 20D, 20E, 30D, 30E, 40, 50, 50E	3	30/600-2	1683301M92	Axe / Shaft 21Z Hautdét / Hi-Flow Avec valve de pression With control valve
	4	30/610-1	1680061M91	Valve de pression Control valve
		30/610-1A	1860114M91	Méthane Plunger
2620, 2625, 2640, 2645, 2675, 2680, 2685, 2705, 2720, 2725, 2745, 2775, 2805, 3620, 3630, 3635, 3645, 3650, 3655, 3670, 3680, 3690, 8110, 8120, 8130, 8140, 8150, 8160	5	30/600-4	3790722M1	
2640, 2645, 2675, 2680, 2685, 2705, 2720, 2725, 2745, 2775, 2805, 3620, 3630, 3635, 3645, 3650, 3655, 3670, 3680, 3690, 6110, 6120, 6130, 6140, 6150, 6160, 6170, 6180, 6190, 8110, 8120, 8130, 8140, 8150, 8160 <i>Montage avec 2 pompes / Fitting with 2 pumps</i>	6	30/600-5	3038732M2	
4215, 4220, 4225, 4235, 4240, 4245, 4255, 4260, 4265, 4270, 4315, 4320, 4325, 4335, 4345, 4355, 4360, 4365, 4370	7	30/600-6	4200076M91 (3800476M91)	

SOUPAPES DE SECURITE / CONTROL VALVES



Tracteurs Tractors	Réf. Ref.	OEM	Remarque Observation
Séries 100, 200, 300 series	30/620-1	1662591M91	Rouge / Red 2300-2800 PSI
Séries 100, 200, 300, 2200, 2600, 2700 series	30/620-2	883402M92	Jane / Yellow 2500-3000 PSI
Séries 100, 200, 300, 2200, 2600, 2700 series	30/620-3	884747M93	Noire / Black 2700-3200 PSI
Séries 300, 4200, 4300 series	30/620-4	3401834M91	Pompe Hi-Fbw For Hi-Flow pump

Les références des pièces sont indicatives.
Nos pièces ne sont pas d'origine

Part numbers are quoted for reference purposes only.
Our parts and accessories are not original.



PIECES DE RECHANGE POUR POMPE HYDRAULIQUE
HYDRAULIC LIFT PUMP SPARE PARTS

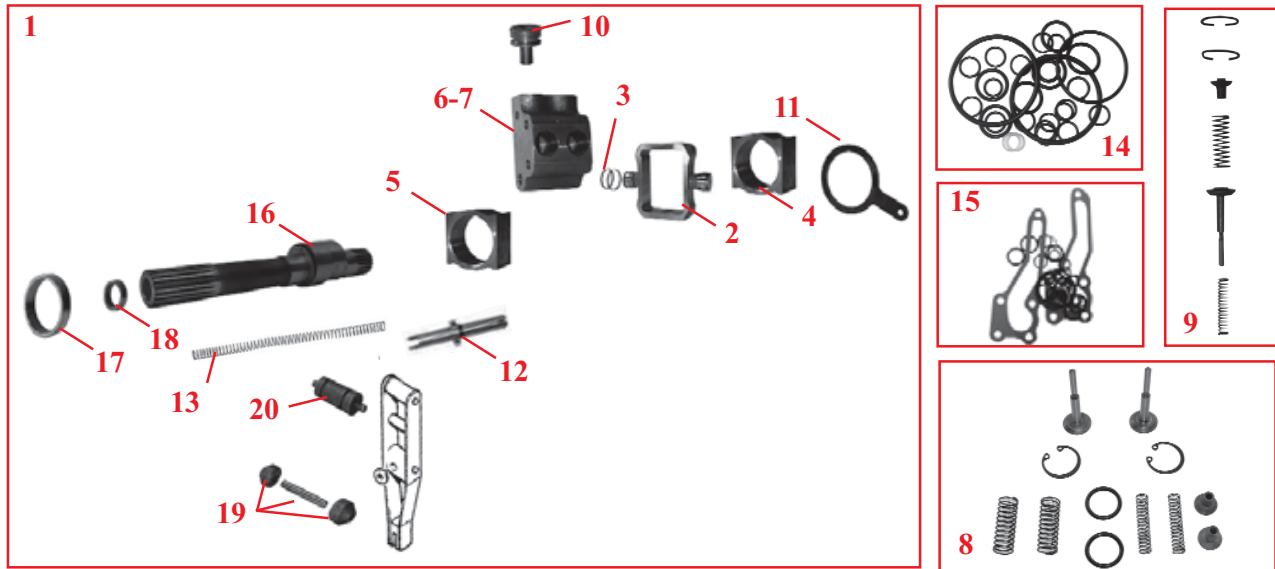

Tracteurs Tractors	Fig.	Description Description	Réf. Ref.	OEM	Remarque Observation
35, 65, 765, 865	1	Kit de réparation / Repair kit Pon / For 30/600-1	30/608-1		2x 30/601-1 (2) + 4x 602-1 (3) + 1x 30/603-1 (4) + 1x 30/604-1 (5) + 2x 30/605-1 (6) + 4x 30/607-1 (10) + 2x 30/606-1 (8) + 1x 30/621-1 (13)
	2	Piston / Piston	30/601-1	190799M1	Ø2.5m
	3	Segment / Ring	30/602-1	892604M1	Ø2.5m
	4	Camavant / Cam block front	30/603-1	180924M2	
	5	Camarrière / Cam block rear	30/604-1	180925M2	
	6	Chambre / Valve chamber	30/605-1	184471M1	
	7	Chambre épée / Valve chamber kit	30/605-1A		
	8	Jeune réparation / Repair kit	30/606-1		
	9	Jeune réparation / Repair kit	30/606-4	1810678M91	Tous types / All models
	10	Bouchon / Plug	30/607-1	181999M1	
	11	Guide / Cam follower	30/609-1	180933M1	
	12	Vanne de contrôle / Control valve	30/615-1	189427M92	
	13	Ressort d'oscillation / Hyd. spring	30/616-1	180940M1	Tous types / All models
	14	Kit o-ring / O-ring kit	30/621-1	894906M91	
	17	Coussinet d'arbre / Bushing	30/617-1	1865012M1	
	18	Rotule d'arbre / Bearing	30/618-1	1000251M1	

Les références des pièces sont indicatives.
Nos pièces ne sont pas d'origine

Part numbers are quoted for reference purposes only.
Our parts and accessories are not original.



PIECES DE RECHANGE POUR POMPE HYDRAULIQUE
HYDRAULIC LIFT PUMP SPARE PARTS

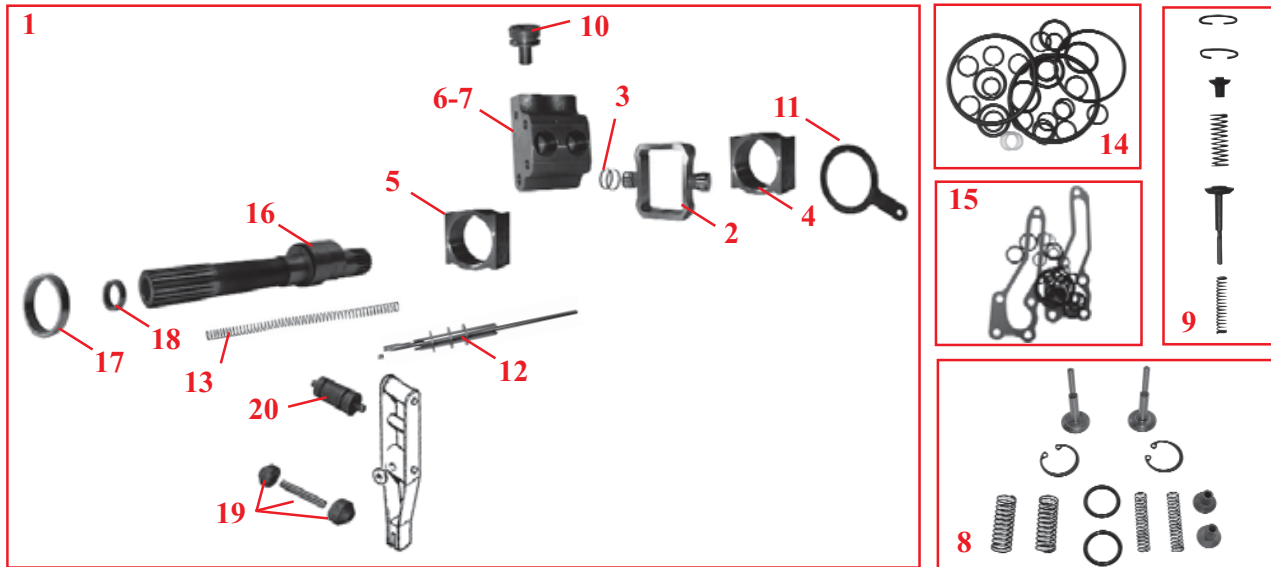

Tracteurs Tractors	Fig.	Description Description	Réf. Ref.	OEM	Remarque Observation
Pope Mark Pump 135, 165, 175, 178  40, 50	1	Kit de réparation / Repair kit	30/608-2	1810858M91	2x 30/601-2 (2) + 4x 602-1 (3) + 1x 30/603-1 (4) + 1x 30/604-1 (5) + 2x 30/605-2 (6) + 4x 30/607-1 (10) + 2x 30/606-1 (8) + 1x 30/621-2 (13)
	2	Piston / Piston	30/601-2	1860038M1	Ø25m
	3	Segment / Ring	30/602-2	897493M1	Ø25m
	4	Camavant / Cam block front	30/603-1	180924M2	
	5	Camarrière / Cam block rear	30/604-1	180925M2	
	6	Chambre / Valve chamber	30/605-2	897491M1	Passage d'huile 11mm Oil pipe 11mm
	7	Chambre épée / Valve chamber kit	30/605-2A		
	8	Jeux réparation / Repair kit	30/606-1		
	9	Jeux réparation / Repair kit	30/606-4	1810678M91	Tous types / All models
	10	Bouchon / Plug	30/607-1	181999M1	
	11	Guide / Cam follower	30/609-1	180933M1	
	12	Valve de contrôle / Control valve	30/615-2	897507M94	
	13	Ressort d'oscillation / Hyd. spring	30/616-1	180940M1	Tous types / All models
	14	Kit o-ring / O-ring kit	30/621-2	1810467M91	
	15	Kit o-ring + joint / O-ring + seal kit	30/621-5	1810684M92	
	16	Arbre à Cam / Camshaft	30/611-1	899915M92	10Z
	17	Coussinet d'arbre / Bushing	30/617-1	1865012M1	
	18	Rotule d'arbre / Bearing	30/618-1	1000251M1	
	19	Jeupivot et rouleau / Lever pin roller	30/614-1	1x897504M1+2x897599M1	
	20	Galet / Roller	30/614-2	898202M1	

Les références des pièces sont indicatives.
Nos pièces ne sont pas d'origine

Part numbers are quoted for reference purposes only.
Our parts and accessories are not original.



PIECES DE RECHANGE POUR POMPE HYDRAULIQUE
HYDRAULIC LIFT PUMP SPARE PARTS

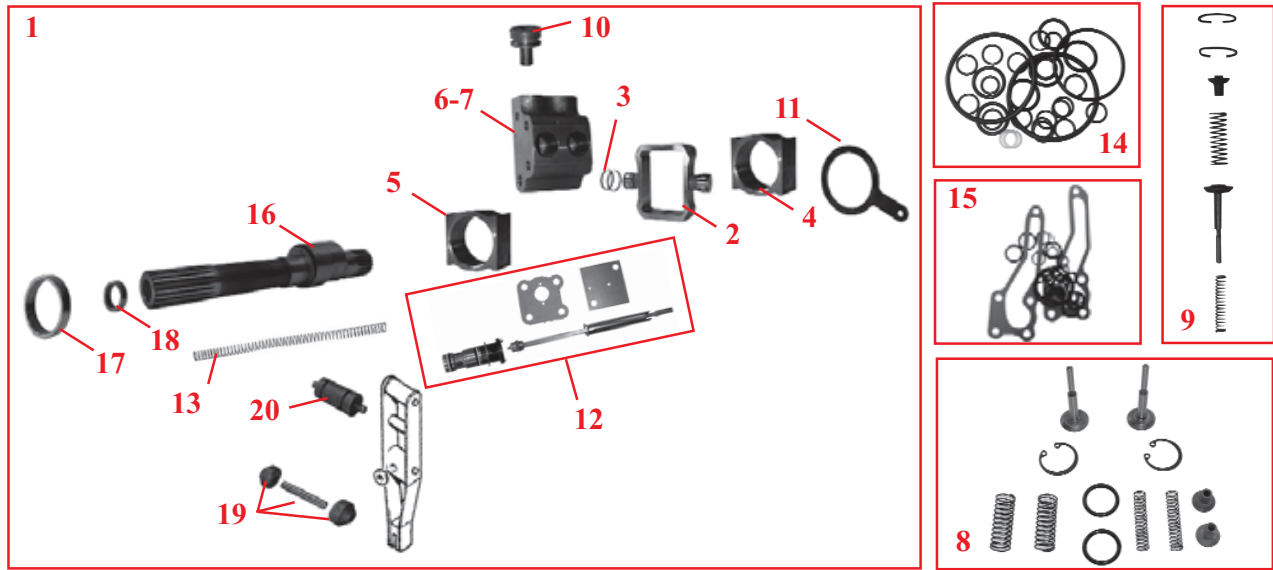

Tracteurs Tractors	Fig.	Description Description	Réf. Ref.	OEM	Remarque Observation
Pope MarkII Pump Série 100 series 595, 1080, 1200	1	Kit de réparation / Repair kit	30/608-4	1810859M91	2x 30/601-2 (2) + 4x 602-2 (3) + 1x 30/603-1 (4) + 1x 30/604-1 (5) + 2x 30/605-4 (6) + 4x 30/607-2 (10) + 2x 30/606-2 (8) + 1x 30/621-5 (13)
	2	Piston / Piston	30/601-2	1860038M1	Ø5m
	3	Segment / Ring	30/602-2	897493M1	Ø5m
	4	Camavant / Cam block front	30/603-1	180924M2	
	5	Camarrière / Cam block rear	30/604-1	180925M2	
	6	Chasse nu / Valve chamber	30/605-4	888702M2	Passage d'ité 11mm Oil pipe 11mm
	7	Chasse épée / Valve chamber kit	30/605-4A		
	8	Jeude réparation / Repair kit	30/606-2		
	9	Jeude réparation / Repair kit	30/606-4	1810678M91	Tous types / All models
	10	Bouchon / Plug	30/607-2	888700M1	
	11	Guide / Cam follower	30/609-1	180933M1	
	12	Valve de contrôle / Control valve	30/615-3	1862486M96	Safi 595 / Except 595
	13	Ressort d'oscillation / Hyd. spring	30/616-1	180940M1	Tous types / All models
	15	Kit o-ring + joint / O-ring + seal kit	30/621-5	1810684M92	
	16	Arbre à Cam / Camshaft	30/611-1	899915M92	10Z
	16	Arbre à Cam / Camshaft	30/611-2	1684621M91	21Z
	17	Cossinet d'arbre / Bushing	30/617-1	1865012M1	
	18	Rotule d'arbre / Bearing	30/618-1	1000251M1	
	19	Jeupivot et rouleau / Lever pin roller	30/614-1		1x897504M1 + 2x897599M1
	20	Gaît / Roller	30/614-2	898202M1	

Les références des pièces sont indicatives.
Nos pièces ne sont pas d'origine

Part numbers are quoted for reference purposes only.
Our parts and accessories are not original.



"THE RELIABLE SERVICE"



PIECES DE RECHANGE POUR POMPE HYDRAULIQUE
HYDRAULIC LIFT PUMP SPARE PARTS

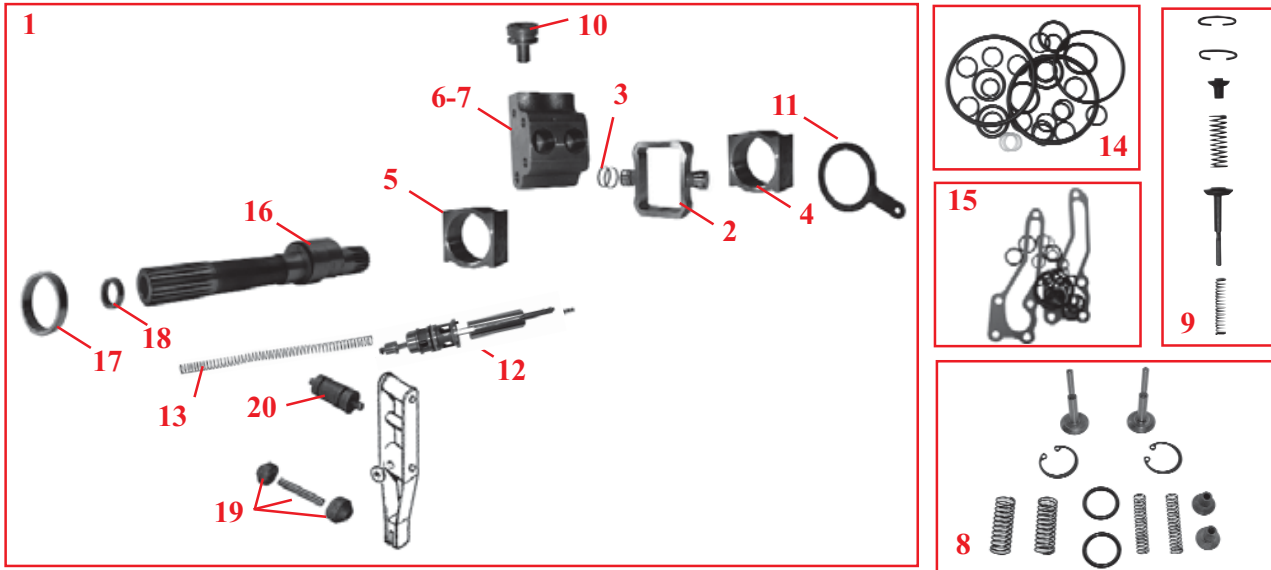

Tracteurs Tractors	Fig.	Description Description	Réf. Ref.	OEM	Remarque Observation
Pompe MarkIII Pump Séries 100, 200, 300, 500, 600, 4200, 4300 series 1200, 1250 20B/D/E, 30D/E	1	Kit de réparation / <i>Repair kit</i>	30/608-3	1810860M93	2x 30/601-2 (2) + 4x 602-2 (3) + 1x 30/603-1 (4) + 1x 30/604-1 (5) + 2x 30/605-3A (6) + 1x 30/621-2 (13)
	2	Piston / <i>Piston</i>	30/601-2	1860038M1	Ø5m
	3	Segment / <i>Ring</i>	30/602-2	897493M1	Ø5m
	4	Camavant / <i>Cam block front</i>	30/603-1	180924M2	
	5	Camarrière / <i>Cam block rear</i>	30/604-1	180925M2	
	6	Chambre / <i>Valve chamber</i>	30/605-3	1868435M3	Passage d'huile 13mm <i>Oil pipe 13mm</i>
	7	Chambre épée / <i>Valve chamber kit</i>	30/605-3A		
	8	Jeune réparation / <i>Repair kit</i>	30/606-3		
	9	Jeune réparation / <i>Repair kit</i>	30/606-4	1810678M91	Tous types / <i>All models</i>
	10	Bouchon / <i>Plug</i>	30/607-3	1868741M1	
	11	Guide / <i>Cam follower</i>	30/609-1	180933M1	
	12	Valve de contrôle / <i>Control valve</i>	30/615-5	1681789M91	⇒ 8/91
			30/615-7	3611085M91	8/91 ⇒
	13	Ressort d'oscillation / <i>Hyd. spring</i>	30/616-1	180940M1	Tous types / <i>All models</i>
	15	Kit o-ring + joint / <i>O-ring + seal kit</i>	30/621-6	1810680M93	
	16	Arbre à cam / <i>Camshaft</i>	30/611-2	1684621M91	21Z
	17	Cossinet d'arbre / <i>Bushing</i>	30/617-2	1664491M2	
	18	Rotule d'arbre / <i>Bearing</i>	30/618-1	1000251M1	
	19	Jeupivot / <i>Lever pin roller</i>	30/614-1		1x897504M1 + 2x897599M1
	20	Gailette / <i>Roller</i>	30/614-2	898202M1	

Les références des pièces sont indicatives.
Nos pièces ne sont pas d'origine

Part numbers are quoted for reference purposes only.
Our parts and accessories are not original.



"THE RELIABLE SERVICE"



POMPES HYDRAULIQUES AUXILIAIRES
AUXILIARY HYDRAULIC PUMPS

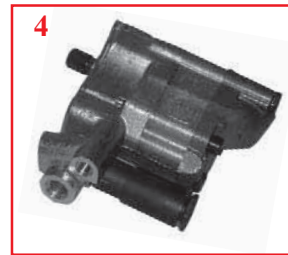
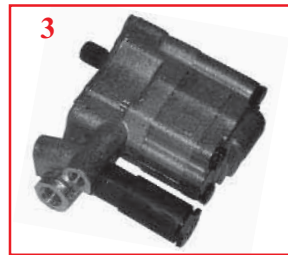
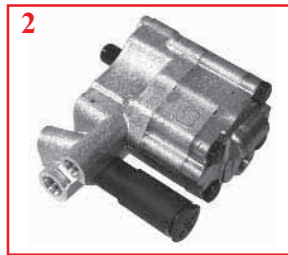

Tracteurs Tractors	Fig.	Réf. Ref.	OEM	Remarque Observation
133, 135, 140, 145, 148, 152, 155, 158, 165, 168, 175, 178, 185, 188, 235, 240, 245, 250, 255, 260, 265, 275, 285, 290, 550, 560, 565, 575, 590, 595, 675, 690, 1200, 1250	1	30/626-3	886821M94	Pompe hi-Power Multi-Power pump
135, 148, 152, 155, 158, 165, 168, 185, 188, 240, 250, 253, 260, 263, 265, 275, 285, 290, 298, 375E, 390E, 550, 560, 565, 575, 590, 595, 630D	2	30/650-2	1686766M91	Pompe auxiliaire 2 sorties Auxiliary pump 2 ports
135, 148, 152, 158, 168, 185, 188, 240, 250, 253, 255, 260, 263, 265, 275, 290, 298, 340, 550, 560, 565, 575, 590, 675, 690, 698, 699, 1004, 1200, 1250	3	30/650-3	1686765M91	Pompe auxiliaire 1 sortie Ø8mm Auxiliary pump 1 port Ø 18mm
592, 595	4	30/650-4	1686767M91	Pompe auxiliaire 1 sortie Ø6mm Auxiliary pump 1 port Ø 36mm

ORBITROL
ORBITROL

Tracteurs Tractors	Fig.	Réf. Ref.	OEM	Remarque Observation
154, 165, 168, 174, 184, 185, 188, 194, 254, 265, 274, 275, 284, 290, 294, 298, 575, 590, 592, 595, 675, 690, 698, 1004, 1014, 1024, 1104, 1114, 1134	1	30/560-16	782509M91	OSPB 100 ON
230, 240, 253, 261, 263, 340, 342, 350, 352, 355, 360, 362, 365, 372N, 375, 382N, 390, 396, 398, 399		30/560-1	3821548M91	OSPC 100 ON - 140 BAR
265, 275, 275E, 285, 290, 290E, 298, 375E, 390E, 675, 690, 698, 698T, 699, 1004T		30/560-32	1684986M91	OSPC 100 ON - 170 BAR
365, 375, 390, 396, 398, 399		30/560-2 30/560-2D Danfoss	1695445M91	OSPC 100 ON - 170 BAR
595, 595MKIII		30/560-29	1808629M91	OSPB 125 ON
3050, 3060, 3065, 6120, 6130, 6140, 6235, 6245, 6255		30/560-30	3383107M91	OSPC 100 ON
3070, 3075, 3080, 3085, 3090, 3095, 3115, 3120, 3125, 6150, 6160, 6170, 6180, 6190, 6235, 6245, 6255, 6260, 6265, 6270, 6280, 6290		30/560-31	3384675M1	OSPB 125 ON
Séries 4200, 4300 series		30/560-1	3821548M91	OSPC 100 ON - 140 BAR
3610, 3630, 3635, 3645, 3650, 3655, 3670, 3690, 8110, 8120, 8130, 8140, 8150, 8160, 8210, 8220, 8240, 8250, 8260 8937, 8939		30/560-33	3712250M1	OSPC 200 LS
Tous modèles Danfoss / All Danfoss models		2	30/561-1	1810503M92
65, 135, 148, 235, 240, 245, 255, 260	3	30/561-3	894969M92	Kit de joints pour valve de DA Seal kit for power steering valve

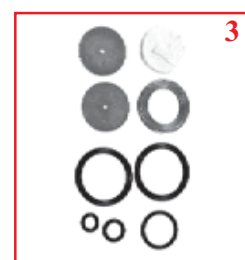
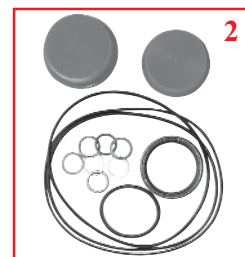

Les références des pièces sont indicatives.
Nos pièces ne sont pas d'origine

Part numbers are quoted for reference purposes only.
Our parts and accessories are not original.



PIECES POUR POMPE HYDRAULIQUE
HYDRAULIC PUMP SPARE PARTS



Tracteurs Tractors	Fig.	Description Description	Réf. Ref.	OEM	Remarque Observation
154, 174, 184, 194, 254, 274	1	Pignon d'axe de pompe Pump shaft gear	30/649-5	1424463M1	Pompe groupe II For Group II pump
194, 274, 284, 294, 1104			30/649-2	1425170M1	Pompe groupe II For Group II pump
1014, 1024, 1114, 1134			30/649-1	1822233M1	Pompe groupe III For Group III pump
1104	2	Arbre de commande de pompe Pump main shaft	30/648-5	1425169M1	Pompe groupe II For Group II pump A remplacer avec 30/649-2 To replace with 30/649-2
1114, 1134			30/648-6	1425496M2	Pompe groupe III For Group III pump
1014, 1024			30/648-7	3301296M1	
134, 154, 174, 184, 194, 233, 234, 253, 254, 273, 274, 283, 284, 293, 294	3	Draine de raccordement du filtre de pompe Pump filter hose	30/645-2	1825234M1	Pompe / For pump 1825210, 1825212
154, 174, 184, 194, 274	4	Fusil d'arbre de pompe Rear Flange	30/6637-2	1424368M1	18Z 31x35m 4 trous de fixation 4 fitting holes
134, 154, 164T, 174, 184, 194, 233, 253, 254, 254S, 263T, 264T/TS, 273, 274, 283, 284, 293, 294, 294S, 333, 334, 353, 354, 363, 364, 373, 374, 377, 383, 384, 387, 393, 394, 394T, 397, 397T, 1007, 3210, 3220, 3225, 3235 Tous modèles / All models			30/6637-3	1424502M3	Cone 14.5x16.5m 4 trous de fixation 4 fitting holes
1014, 1024, 1114, 1134			30/6637-4	1425497M2	14Z 22x25m 3 trous de fixation 3 fitting holes
154, 174, 184, 194, 254, 274, 284, 294, 397, 1007, 1104, 1114, 1134	5	Siège de Damper	30/6618-2	828724M1	
1014, 1024, 1114, 1134 Pompe de direction assistée Power steering pump	6	Accouplement Coupling	30/648-8	1425492M92	
	7	Siège de Damper	30/6618-3	3300937M1	

Les références des pièces sont indicatives.
Nos pièces ne sont pas d'origine

Part numbers are quoted for reference purposes only.
Our parts and accessories are not original.



DISTRIBUTEURS HYDRAULIQUES HYDRAULIC SPOOL VALVES

Tracteurs ancienne gamme
Old range tractors

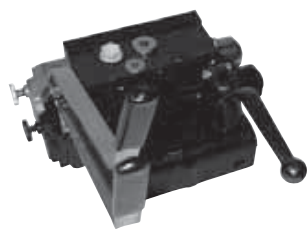

Éléments compatibles / double effet 300bars - 45l/min Gunther-Till
Se monte à l'aplacement prévu sur le couvercle du relevage (Sous le siège).
La vanne isolatrice permet de dévier le débit d'huile vers le relevage ou vers l'élement de travail
*Single double acting changeover unit 300 bars - 45l/min - "Gunther Till" fitting.
Fitted in the foreseen place on the lift cover (Under the seat)
The isolator valve let you the choice to send the oil to the lift or to the unit*

30/7600-22 : Groupe de base flasqué avec vanne isolatrice et un élément de travail
Basic spool valve with isolator valve and 1 unit

30/7601-7 : Élément supplémentaire / *Additional unit (A)*
30/7615-7 : Jeu de 4 vis pour 1 élément / *4 screws set for 1 unit*
30/7615-9 : Jeu de 4 vis pour 2 éléments / *4 screws set for 2 units*

Série 500 series
Came de la Cab



Distributeur avec table de commande et accessoires.
Spool valve with command panel and accessories.

30/7600-24 : Groupe de base flasqué avec un élément de travail
Basic spool valve with 1 unit

30/7601-5 : 1er élément supplémentaire / *1st Additional unit*
30/7602-4 : 2ème élément supplémentaire / *2nd Additional unit*

154, 174, 184, 194,
254, 274, 284, 294



30/7600-25 : Élément simple / double effet - Fixation 2 goujons
Single double acting changeover unit - 2 bolts fitting
(1424273M91,
1426921M92)

6180, 6190, 6235, 6245, 6255, 6260,
6265, 6270, 6280, 6290, 8110, 8120,
8130, 8140, 8150, 8160

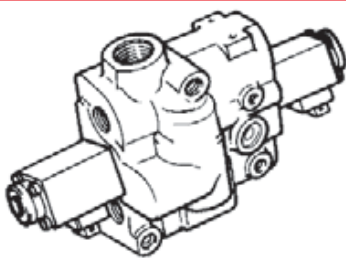

30/7611-6 : Valve hydraulique
Hydraulic spool valve
(3790388M2)

(A) Existe aussi avec fixation 3 trous : **30/7601-8**
Can be ordered with a 3 holes fitting : 30/7601-8

Les références des pièces sont indicatives.
Nos pièces ne sont pas d'origine

*Part numbers are quoted for reference purposes only.
Our parts and accessories are not original.*



VANNE ISOLATRICE DE RELEVAGE
LIFT ISOLATOR VALVE

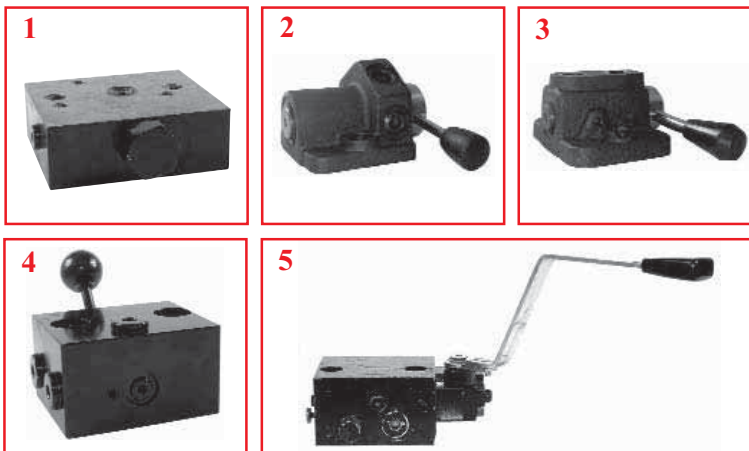

Réf. Ref.	Fig.	Description Description
30/7608-3	1	Plaq de protection avec soupape pour série 100 avec régulateur de pression Safety plate with valve for 100 series with pressure regulator
30/7611-7	2	Vanne isolatrice - 2 sorties - 1 retour Isolator valve - 2 outlets - 1 return
30/7611-8	3	Vanne isolatrice - 2 sorties Isolator valve - 2 outlets
30/7611-9	4	Vanne isolatrice - Gunther Till Isolator valve - "Gunther Till"
30/7611-11	5	Vanne isolatrice - Gunther Till - Soupape de surpression et maintien des bras en position haute avec commande à distance - Séries 500 Isolator valve - "Gunther Till" - Overpressure valve and hold the lift arm in upper position with remote control - 500 series

Les références des pièces sont indicatives.
Nos pièces ne sont pas d'origine

Part numbers are quoted for reference purposes only.
Our parts and accessories are not original.



RELEVAGE HYDRAULIQUE
HYDRAULIC LIFT

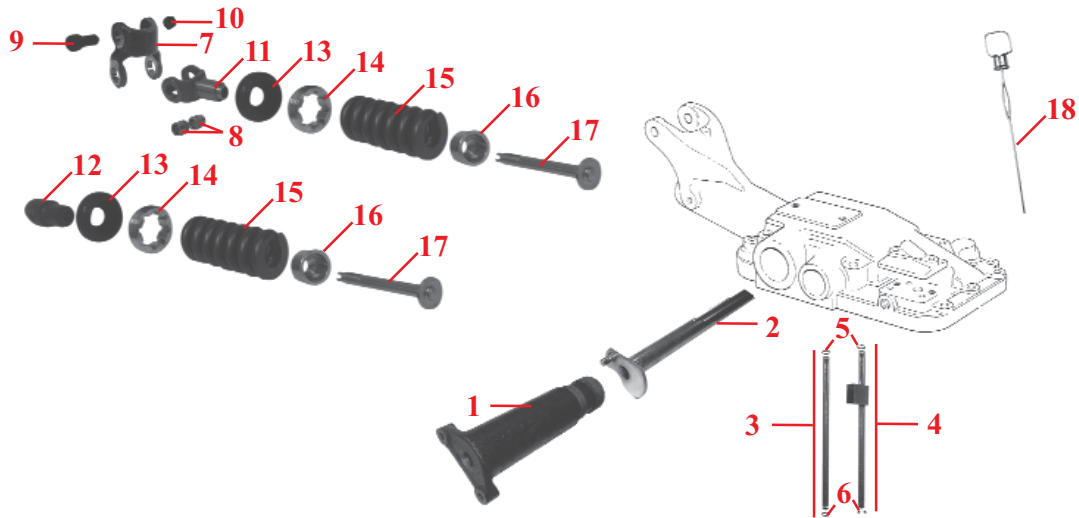

Tracteurs Tractors	Fig.	Réf. Ref.	OEM	Description
135 (439192 ⇔), 148, 165 (132850 ⇔), 168, 185, 188, 230, 240, 250, 253, 255, 260, 263, 265, 275, 290, 298, 340, 342, 350, 352, 355, 360, 365, 372N, 375, 382N, 385, 390, 390T, 398, 399, 550, 565, 575, 590, 675, 690, 698, 698T, 699, 1004	1	30/658-1	1870240M1	Spport Support
	2	30/659-1	1870220M93	Arbe avec contrb de pression Shaft with pressure sensing
133, 135, 140, 145, 152, 155, 158, 165, 175, 178, 230, 240, 253, 263, 275, 290, 340, 342, 350, 352, 355, 360, 365, 375, 390, 592, 595, 1080, 1085, 1200, 1250	3	30/661-1	898229M1	Canalsation / Pipe Lg 317m Pon pope standard For standard pump Inch / Included : 2x 30/590-012 (6) &x 30/592-012 (5)
		30/661-3	1869119M1	Canalsation / Pipe Lg 249m Pon pope Hi-Fbw For Hi-Flow pump Inch / Included : 2x 30/590-012 (6) &x 30/592-012 (5)
133, 135, 140, 145, 148, 152, 155, 158, 165, 168, 185, 188, 235, 240, 245, 250, 255, 260, 265, 275, 285, 290, 298, 340, 350, 355, 360, 365, 375, 382N, 390, 398, 399, 550, 560, 565, 575, 590, 675, 690, 698, 699, 1004, 1085	4	30/661-2	883788M91	Canalsation avec control de pression Pipe w/pressure control Lg 317m Inch / Included : 2x 30/590-012 (6) &x 30/592-012 (5)
Tous modèles équipés avec : All models fitted with : 30/661-1, 30/661-2, 30/661-3	5	30/592-012	195874M1	Ronde / PTFE backup ring
	6	30/590-012	195561M1	Joint toriq / O-ring 9.5 x 1.6
35, 65, 765, 133, 135, 140, 145, 155, 165, 230, 235, 240, 245, 340	7	30/665-1	180973M2	Chape / Rocker link
35, 65, 765, 133, 135, 140, 145, 155, 165, 230, 235, 240, 245, 340	8	30/668-1	180974M1, 181982M1	Baga / Bush
	9	30/666-1	358178X1 363593X1	Vis / Screw UNF 1/2"- 35x16
	10	30/670-1	180972M2	Chape / Clevis
133, 135, 140, 148, 152, 158, 165, 168, 175, 178, 185, 188, 230, 240, 340 Renforcé / Heavy duty 250, 265, 275, 285, 290, 298, 342, 350, 352, 355, 360, 362, 365, 372N, 375, 382N, 390, 398, 399, 550, 565, 575, 590, 675, 690, 698, 699	11	30/670-2	1863389M1	Chape / Clevis

Les références des pièces sont indicatives.
Nos pièces ne sont pas d'origine

Part numbers are quoted for reference purposes only.
Our parts and accessories are not original.



**RELEVAGE HYDRAULIQUE
HYDRAULIC LIFT**

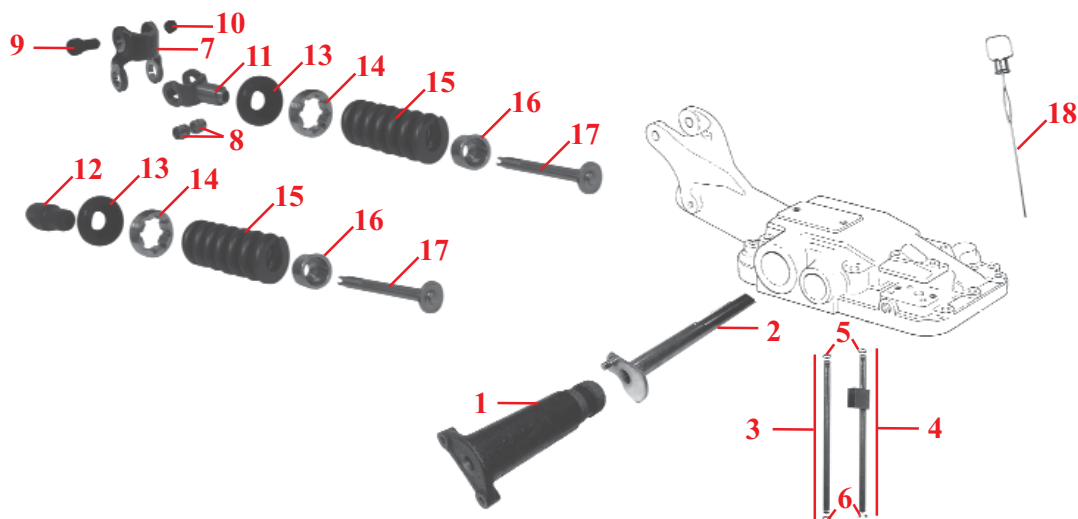

Tracteurs Tractors	Fig.	Réf. Ref.	OEM	Description
Tous modèles All Models	13	30/671-1	887654M2	Capuchon / Rubber boot
	14	30/672-1	180979M2	Ecrou / Nut
	15	30/673-1	182582M1	Ressort / Spring
Normal	16	30/674-1	182581M1	Siège / Control seat
Renforcé / Heavy duty		30/674-2	886351M91	Siège / Control seat
35, 65, 765	17	30/676-1	182580M1	Piston / Plunger
Normal		30/676-2	898136M1	Piston / Plunger
Renforcé / Heavy duty		30/676-3	886348M1	Piston / Plunger
Tous modèles All Models	18	30/677-1	1665962M91	Jauge / Dipstick

Les références des pièces sont indicatives.
Nos pièces ne sont pas d'origine

Part numbers are quoted for reference purposes only.
Our parts and accessories are not original.



RELEVAGE HYDRAULIQUE
HYDRAULIC LIFT

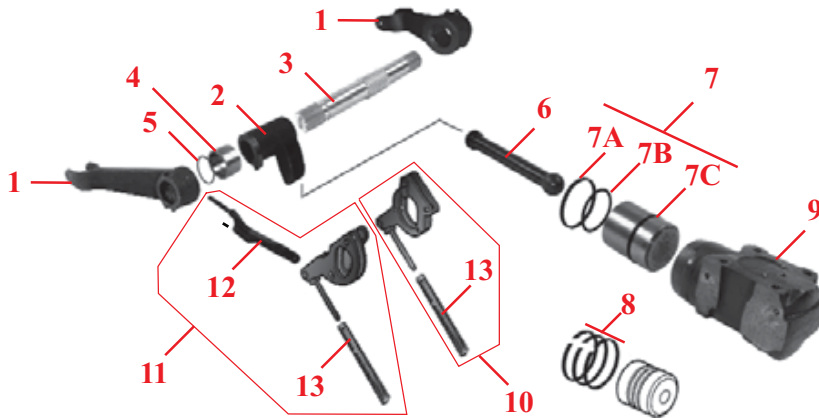

Tracteurs Tractors	Fig.	Réf. Ref.	OEM	Description
133, 135, 140, 145, 148, 152, 155, 158, 165 (Std), 230, 235, 240, 245, 250, 255, 340 (Std), 550, 560	1	30/682-1	885444M91	Bras G Ø avec bûges 5/8" LH & RH arms with 5/8" bush
165 (Renforcé/Heavy duty), 168, 175, 178, 185, 188, 265, 275, 285, 290, 298, 340 (Renforcé/Heavy duty), 342, 350, 352, 360, 362, 365, 372N, 375, 382N, 390, 398, 399, 565, 575, 590, 675, 690, 698, 699, 1004		30/682-4	1680040M91	Bras G Ø avec bûges 7/8" LH & RH arms with 7/8" bush
Séries 4200, 4300 series		30/682-10	3817639M91	Bras G Ø / LH & RH arms
35, 65, 765	2	30/684-1	180970M2	Bras central Middle arm
133, 135, 140, 148, 155, 165, 230, 235, 240, 245, 250, 550, 560		30/684-2	886405M1	
158, 165 (Renforcé/Heavy duty), 168, 175, 178, 185, 188, 265, 275, 285, 290, 565, 575, 590, 592, 595, 675, 690, 698, 699, 1004, 1080, 1085, 1200, 1250		30/684-3	886404M2	
Séries 4200, 4300 series		30/684-10	3801057M1	
230, 240, 253, 263, 275 (P12018 ⇨), 290 (P06156 ⇨), 340, 342, 352, 362, 365, 372N, 375, 382N, 390, 396, 398, 399		30/684-11	3610357M2	
35, 65, 765	3	30/685-1	184359M2	Arbre Shaft
133, 135, 140, 145, 152, 155, 185, 165, 168, 175, 178, 185, 188, 230, 235, 240, 245, 250, 253, 255, 260, 263, 265, 275, 285, 290, 298, 340, 342, 350, 352, 355, 360, 362, 365, 372N, 375, 382N, 390, 396, 398, 399, 550, 560, 565, 575, 590, 675, 690, 698, 699, 1004, 1200		30/685-2	897567M3	
254, 274, 284, 293, 294		30/685-8	1825287M2	
Séries 4200, 4300 series	30/685-12	3810970M1	Bûche / Bush Ø"	
35, 65, 765	30/686-1	180018M1		
133, 135, 140, 145, 152, 155, 165, 168, 175, 178, 185, 188, 230, 235, 240, 245, 250, 253, 255, 260, 263, 265, 275, 285, 290, 298, 311, 340, 342, 350, 352, 355, 360, 362, 365, 372N, 375, 382N, 390, 396, 398, 399, 550, 560, 565, 575, 590, 675, 690, 698, 699, 1004, 1200	30/686-3	1870934M1		
154, 164T, 174, 184, 194, 233, 234, 244CF, 253, 254, 263, 264, 273, 274, 283, 284, 293, 294, 333, 353, 354, 356CF, 364, 366, 367CF, 373, 374, 376C, 377, 383, 384, 387, 393, 394, 396, 397, 1007, 1104, 3210, 3220, 3225, 3235	30/686-3A	886029M1		
	30/686-12	3611558M1	Bûche / Bush 2nd montage / 2nd Fitting	
Séries 4200, 4300 series	4	30/686-10	1819841M1	Bûche Gauche / LH Bush 55x60x40
		30/686-11	1825272M1	Bûche droite / RH Bush 60x65x40
35, 65, 765	5	30/686-13	3801052M1	Bûche+O-ring / Bush+O-ring 3823623M1+3823624M1
133, 135, 140, 145, 152, 155, 185, 165, 168, 175, 178, 185, 188, 230, 235, 240, 245, 250, 253, 255, 260, 263, 265, 275, 285, 290, 298, 340, 342, 350, 352, 355, 360, 362, 365, 372N, 375, 382N, 390, 396, 398, 399, 550, 560, 565, 575, 590, 675, 690, 698, 699, 1004, 1200		30/687-1	195565M1	O-ring
2620, 2625, 2640, 2645, 2675, 2680, 2685, 2705, 2720, 2725, 2745, 2775, 2805, 3610, 3630, 3635, 3645, 3650, 3655, 3670, 3680, 3690, 8110, 8120, 8130, 8140, 8150, 8160		30/687-2	359136X1	
133, 135, 140, 145, 152, 155, 158, 165, 168, 175, 178, 185, 188, 230, 235, 240, 245, 250, 260, 265, 275, 285, 290, 298, 550, 560, 565, 575, 590, 595, 675, 690, 698, 699, 1004, 1080, 1085, 1200, 1250	30/687-7	3045418M1		
Séries 4200, 4300 series	6	30/689-1	886410M1	Bielles / Connecting rod
		30/689-5	3808161M1	

Les références des pièces sont indicatives.
Nos pièces ne sont pas d'origine

Part numbers are quoted for reference purposes only.
Our parts and accessories are not original.



"THE RELIABLE SERVICE"



**RELEVAGE HYDRAULIQUE
HYDRAULIC LIFT**

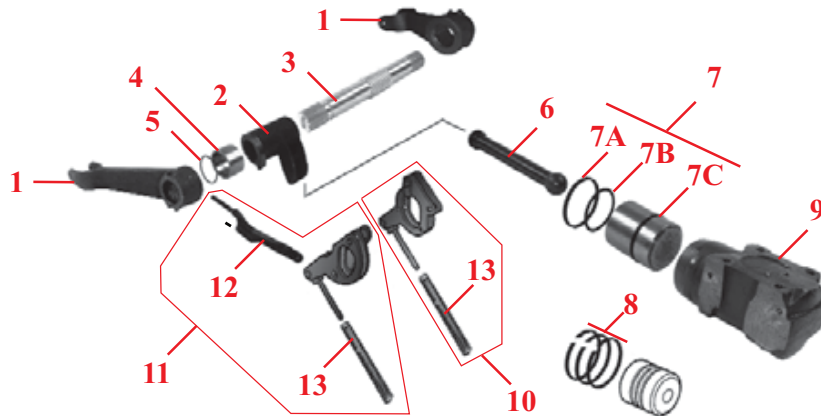

	7	7A	7B	7C	8	9
Tracteurs Tractors	Jeu piston Piston set	Coupelle Ring	O-Ring O-ring	Piston Piston	Segments Rings	Cylindre Cylinder
TE20, FE35					30/692-43 (180898M1)	
35, 65, 765					30/692-1 (184447M1) 3"	
133, 135, 140, 145, 152, 155, 165, 235, 240, 245, 250, 255, 550, 560	30/690-4 (1665737M91) 3 1/8"	30/692-17 (3761478M1)	30/692-18 (3761475M1)	30/691-4	30/692-2 (897564M1) 3 1/8"	30/693-3 (897560M3) 3 1/8"
158, 168, 175, 178, 185, 188, 260, 265, 275, 285, 290, 298, 565, 575, 590, 675, 690, 698, 699, 1004, 1200, 1250	30/690-5 (1665738M91) 3 3/8"	30/692-19 (3761477M1)	30/692-20 (3761474M1)	30/691-5	30/692-3 (897597M1) 3 3/8"	30/693-4 (1671082M1) 3 3/8"
253, 263, 275, 290, 342, 350, 352, 355, 360, 362, 365, 372N, 375, 382N, 390, 396, 398, 399	30/690-6 (1693921M93)					30/693-10 (3599859M1)
Séries 4200, 4300 series		30/692-40 (3761476M1)	30/692-41 (3761473M1)	30/691-10 (3808136M1)		

	10	11	12	13
Tracteurs Tractors	Jeu bielle Link assy.	Jeu bielle Link assy.	Bielle O-ring	Ressort Spring
Séries 100, 200, 300, 500, 600 series (Safi/ Not 298, 398, 399, 698, 699)	30/695-1 (1661918M91)	30/696-1 (1660324M91)	30/697-1 (898124M1)	30/699-1 (1660323M1)
1004, 1200, 1250, 4215, 4220, 4225, 4235, 4240, 4245, 4255, 4265, 4315, 4320, 4325, 4345, 4355, 4365				
298, 398, 399, 698, 699, 4260, 4270, 4360, 4370 4265, 4365 (Avec attelage avant / With front linkage)	30/695-2 (1690886M91)	30/696-2 (1690884M91)	30/697-2 (516574M1)	

Les références des pièces sont indicatives.
Nos pièces ne sont pas d'origine

Part numbers are quoted for reference purposes only.
Our parts and accessories are not original.



"THE RELIABLE SERVICE"



RELEVAGE HYDRAULIQUE HYDRAULIC LIFT

Ressort de contrôle de profondeur - *Depth control spring*

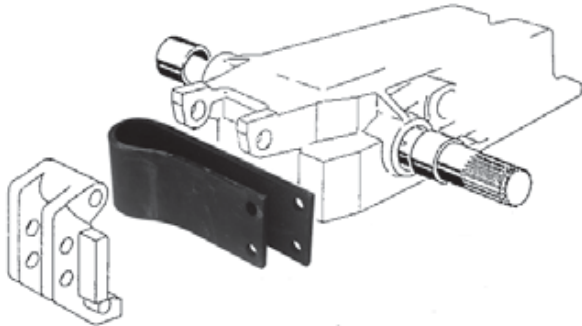

Tracteurs Tractors	Réf. Ref.	Description
134, 154, 164T, 174, 184, 194, 233, 234, 253, 254, 273, 274, 283, 284, 293, 294, 354, 364, 374, 384, 394, 3210, 3220, 3225, 3235	30/6677-5 (1825299M1)	Epaisseur 12mm Thickness 12mm
154, 164T, 174, 184, 194, 233, 234, 253, 254, 263, 264, 273, 274, 284, 293, 294, 333, 353, 354, 356CF, 363, 364, 366, 367CF, 373, 374, 376C, 377, 383, 384, 387, 393, 394, 396, 397, 1007, 3210, 3220, 3225, 3235	30/6677-6 (3307673M1)	Epaisseur 14mm Thickness 14mm

Arbre de contrôle de profondeur - *Depth control shaft*

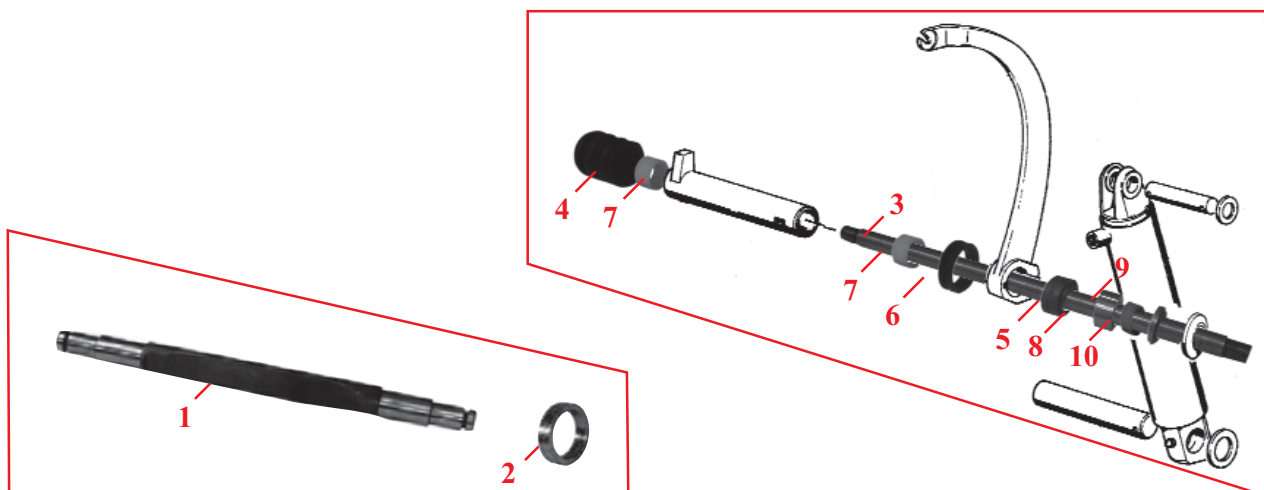

Tracteurs Tractors	Fig.	Réf. Ref.	OEM	Description
2620, 2625, 2640, 2645, 2680, 2685, 2720	1	30/6678-17	3042317M4	Arbre / Shaft
	2	30/6679-21	3384311M91	Bague / Bush
1014, 1024, 1114, 1134	3	30/6678-19	1425330M2	Arbre / Shaft
	4	30/6682-16	1425338M1	Protecteur D / Protector RH
	5	30/6682-17	1425347M2	Protecteur G / Protector LH
	6	30/6679-17	1426683M1	Joint / Gasket
	7	30/6679-16	1425344M1	Bague / Bush
	8	30/6679-18	392283X1	Manchon / Bushing
	9	30/6641-2	1427441M1	Bague / Bush
	10	30/6682-18	392210X1	Anneau / Ring

Les références des pièces sont indicatives.
Nos pièces ne sont pas d'origine

Part numbers are quoted for reference purposes only.
Our parts and accessories are not original.



**BARRES DE POUSSEE
TOP LINKS**



Tracteurs Tractors	Cat.	Dim. Size	1 Barre standard Standard top link	2 Barre renforcée Heavy duty top link	3 Rotule droite Côté tracteur RH ball end Tractor side	5 Tube standard Standard centre tube	6 Tube renforcé Heavy duty centre tube	4 Rotule gauche Côté machine LH ball end Implement side
35, 133, 135, 140, 145, 148, 152, 158	1+1	1 ^{1/16} UNF 575-725m	30/700-1 (180855M91, 184134M91, 1870075M91)	30/700-35	30/701-1 (184079M91)	30/702-1 (184891M91) Lg. :440m	30/702-14	30/703-1 (183619M92)
65, 133, 135, 140, 148, 165, 230, 235, 240, 245, 250, 340, 550	1+1	1 ^{1/16} UNF 610-762m	30/700-2 (184078M91, 1869954M91)	30/700-36		30/702-2 (184225M91, 1884762M91) Lg. :480m	30/702-11	
65, 133, 135, 140, 148, 152, 155, 165, 240, 250, 255	2+1	1 ^{1/16} UNF 610-762m	30/700-4 (894376M91)	30/700-37	30/701-2 (183623M93)	30/702-2 (184225M91, 1884762M91) Lg. :480m	30/702-11	
65, 165, 765	2+2	1 ^{1/16} UNF 610-760m	30/700-5 (893438M91)			30/702-2 (184225M91, 1884762M91) Lg. :480m		30/703-2 (183615M93)
65, 155, 165 <i>Hatdegagement High clearance</i>	1+1	1 ^{1/16} UNF 680-832m	30/700-6 (184361M91)	30/700-33	30/701-1 (184079M91)	30/702-3 (184362M91, 1887286M91) Lg. :545m	30/702-12	30/703-1 (183619M92)
65, 165, 765 <i>Hatdegagement High clearance</i>	1+2	1 ^{1/16} UNF 680-830m	30/700-7 (883797M91)	30/700-34		30/702-3 (184362M91, 1887286M91) Lg. :545m	30/702-12	30/703-2 (183615M93)
65, 165, 765 <i>Hatdegagement High clearance</i>	2+1	1 ^{1/16} UNF 680-830m	30/700-8 (894377M91)	30/700-38	30/701-2 (183623M93)	30/702-3 (184362M91, 1887286M91) Lg. :545m	30/702-12	30/703-1 (183619M92)
65, 165, 765 <i>Hatdegagement High clearance</i>	2+2	1 ^{1/16} UNF 680-830m	30/700-9 (893439M91, 1887285M91)	30/700-39		30/702-3 (184362M91, 1887286M91) Lg. :545m	30/702-12	30/703-2 (183615M93)
265, 275, 290, 298, 350, 362, 365, 372N, 375, 382N, 390, 396, 398, 399, 575, 590, 592, 595, 675, 690, 698, 1080 + modèles suivant longueur + models see length	2+2	1 ^{1/4} UNC 660-860m	30/700-10 (1660050M91)	30/700-32	30/701-3 (1660055M91)	30/702-4 (1660051M91) Lg. :530m		30/703-3 (1660053M91)
3050, 3060, 3065, 3070, 3075, 3080, 3085, 3090, 3095, 3115, 3125, 6110, 6120, 6130, 6140, 6150, 6160, 6170, 6235, 6245, 6255, 6260, 6265, 6270, 6280, 6290	2+2	1 ^{1/4} UNC 610-810m	30/700-23 (3382848M91, 3615054M3)		Côté machine Implement side			Côté tracteur Tractor side
		30x3 580-780m		30/700-24 (2A) (3387083M91, 3615052M4)		30/701-13 (3382853M91)	30/702-13 (3382849M91)	30/703-13 (3382851M91)

Les références des pièces sont indicatives.
Nos pièces ne sont pas d'origine

Part numbers are quoted for reference purposes only.
Our parts and accessories are not original.



BARRES DE POUSSEE TOP LINKS

Broches de barre de poussée / Top link pins

Réf. Ref.	OEM	Cat.	ØA	L
30/704-1	195589M1	1	19m	95m
30/704-2	831513M1	1	19m	86m
30/704-3	892476M1 3582043M2	2	25m	103m



Pivots de bras inférieur / Lower link arm pins

Tracteurs Tractors	Réf. Ref.	OEM	ØA	ØB	ØC	Fig.
TE20, 35, 37, 133, 135, 140, 148	30/710-1	181229M5	5/8"	7/8"	5/8"	
65, 145, 152, 155, 158, 165, 175, 178 <i>Tropettes rondes / Round trumpet</i>	30/710-2	184356M1 893419M1	3/4"	1"	3/4"	
133, 135, 148, 235, 240, 245, 250, 550	30/710-3	1867851M2 1867851M3	5/8"	1"	3/4"	
Série 100 series <i>Tropettes carrées / Square trumpet</i>	30/710-4	1695314M1 1867243M1 906263M2	-	1"	-	
Series 200, 300, 500, 600, 4200, 4300 series 334V, 354, 364, 374, 384 AP/FP/GE/SP/V/VQ 374, 384, 394, 3220, 3225, 3235 AP(X)/FP(X)/GE(X)/SP(X) <i>Marchepied / Footstep</i>	30/710-10	3537827M1	13/16"	1 1/8"	1 1/4"	

Arbre de bras inférieur / Lower link arm shaft

Tracteurs Tractors	Réf. Ref.	OEM	Fig.
154, 154F/S, 164TF/TS, 174, 174F/S, 184, 184F/S, 194, 194F/S, 233, 234S, 253, 254, 254S, 263T, 264T/TS, 273, 274, 274S/SK, 283, 284, 284S, 293, 294, 294S, 333, 353, 353S, 363, 363S, 373, 373S, 377, 383, 383S, 387, 393, 393S, 397, 397T, 1007	30/6678-18	1423696M1	

Pivots de carter central / Centre housing rear hinge pin

Tracteurs Tractors	Réf. Ref.	OEM	Fig.
35, 65, 133, 135, 135V, 140, 145, 145V, 148, 152, 152F/V/S, 155, 158, 158F/V/S, 165, 168, 168F/S, 175, 175S, 178, 185, 188, 230, 231, 235, 240, 245, 250, 253, 255, 261, 263, 265, 275, 275E, 285, 290, 290E, 298, 342, 352, 362N, 365, 372N, 375, 375E, 382N, 390, 390E, 390T, 396, 398, 399, 765, 835, 865, 1004, 1004T, 1080 Séries 500, 600, 4200 series	30/334-1	180901M91	

Goujons pour barre d'attelage et attelage automatique / Linkage bolts

Dimension Size	Réf. goujon Bolt number	Illustration goujon Bolt illustration	Illustr. écrou Nut illustr.	Réf. écrou Nut number
3/4"UNF	30/791-3 (899304M1)			30/484-1 (353435X1)
5/8"UNF x 60m	30/791-2 (645931M1)			30/443-1 (353427X1)
5/8"UNF x 70m	30/791-1 (645930M2)			



Les références des pièces sont indicatives.
Nos pièces ne sont pas d'origine

Part numbers are quoted for reference purposes only.
Our parts and accessories are not original.





**BARRES DE POUSSEE
TOP LINKS**

Sphères amovibles et clips pour bras / Link ball & retainer clip

Réf. Ref.	OEM	Cat.	Largeur Width	Fig.
30/720-1	886428M1	1	1 3/8"	
30/720-2	886429M1	2	1 3/4"	
30/720-6	3106506M1	1+2	1 3/4"	
30/721-2	1860936M1 1869219M1	-	-	

Extrémités rotulées / Lower link arm end

Réf. Ref.	OEM	Cat.	Côté Side	Observation	Fig.
30/713-3	184461M92	2	Droit / RH	Anvil / Removable 65, 165, 365, 375, 390, 690	
30/713-4	184462M92		Gauche / LH		
30/716-5	188359M1 + 188148M1 + 353957X1 + 491105M1		25m	Kit de montage / Fitting kit Pour / For 30/713-3 & 0/713-4	
30/714-3	826769M1	1	Droit / RH	A souder / Weld on Pontas / For arm 30/712-2	
30/714-4	826768M1		Gauche / LH		

Cables de commande de crochet / Auto Hitch cables

Tracteurs Tractors	Réf. Ref.	OEM	Longueur A Length A
			
342, 352, 362N, 365, 372N, 375, 382N, 390, 390T, 398 (Cable LowProfile cab)	30/774-2	3701955M91	665m
365, 375, 390, 390T, 396, 398, 399 (Cable Hi-Line cab)	30/774-3	3701954M91	745m
4215, 4220, 4225, 4235, 4240, 4245, 4255, 4260, 4265, 4270, 4315, 4320, 4325, 4335, 4345, 4355, 4360, 4365, 4370	30/774-4	3815365M92	1820m
	Longueur d'ajustement 70mm Adjustment length 70mm		
4215, 4220, 4225, 4235, 4240, 4245, 4255, 4265, 4315, 4320, 4325, 4335, 4345, 4355, 4365 (Avec contrôle électronique durebavage / With electronic lift control)	30/774-5	3820874M92	1820m
	Longueur d'ajustement 120mm Adjustment length 120mm		

Les références des pièces sont indicatives.
Nos pièces ne sont pas d'origine

Part numbers are quoted for reference purposes only.
Our parts and accessories are not original.



ATTELAGE INFERIEUR - BRAS DE RELEVAGE
LOWER LINK ARM

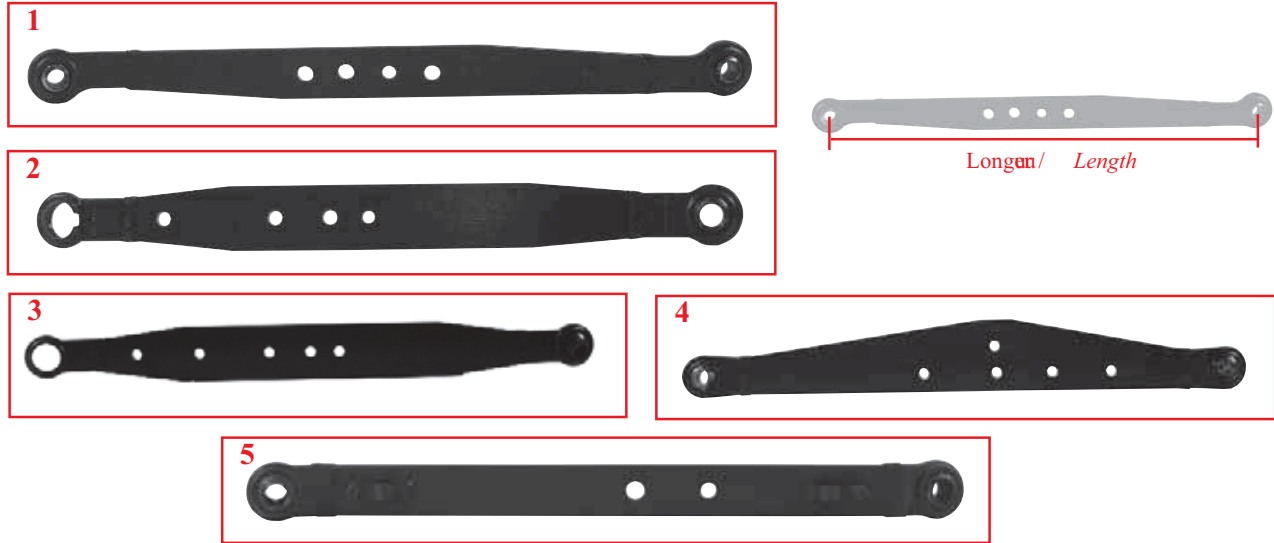

Tracteurs Tractors	Bras gauche LH arm	Bras droit RH arm	Fig.	Cat.	Type	Longueur Length
TE20, 35, 133, 135, 140	30/712-2 (882698M92)		1	1-1	A-A	815m 32"
35, 133, 135, 140	30/712-4 (886433M92)	30/712-5 (886432M92)		1-2		
133, 135, 140, 148, 152, 235, 240, 550	30/712-10 (1869289M91)		2	1-	A-B	890m 35"
65, 165, 175S, 765 Bas dégagement / Low clearance	30/712-6 (1884761M91)		1	1-2	A-A	865m 34"
65, 165, 765 Bas dégagement / Low clearance	30/712-7 (1884763M91)			2-2		
65, 165, 175, 178, 765 Haut dégagement / High clearance	30/712-8 (894388M93)			1-2		
65, 165, 175, 178, 765 Haut dégagement / High clearance	30/712-9 (893430M93)			2-2		
165, 175, 178, 240, 250, 253, 263, 265, 342, 350, 352, 355, 360, 362, 565	30/712-11 (886451M94)		2	2-	A-B	965m 38"
165, 168, 185, 260, 265, 275, 365, 390, 575, 590, 675	30/712-12 (1863435M95)		3	2-		
265, 275, 290, 350, 362, 365, 372N, 375, 382N, 390, 398, 399, 575, 590, 675, 690, 698, 699	30/712-13 (1660263M93)	30/712-14 (1660262M93)	4		A-A	1020m 40"
283, 284, 293, 294	30/712-26 (1423693M91)		5	2-2	A-A	965m 38"
154, 174, 184, 194, 234, 254, 263, 264, 273, 274, 333, 353, 363, 373, 377, 383, 393	30/712-27 (3533293M91)					890m 35"

Type

- A :Rotb fixe
Fixed link ball
- B :Rotb amvib non fournie
Replaceable link ball (Not supplied with)

Les références des pièces sont indicatives.
Nos pièces ne sont pas d'origine

Part numbers are quoted for reference purposes only.
Our parts and accessories are not original.



**STABILISATEURS
STABILISERS**



Tracteurs Tractors	Fig.	Réf. Ref.	OEM	Description
TE20, 35, 37, 65, 135, 148, 152	1	30/735-1		Filetage / Thread :3/4"UNC A :7/8" B :7/8" L :370-465m
	2	30/735-2	184568M91	Filetage / Thread :3/4"UNF A :3/4" B :3/4" L :710-900m
	3	30/729-1	646099M91 881662M94	Sabt gauch / LH bracket - Pivot / Pin 7/8"
30/729-2		646104M91 881664M94	Sabt droit / RH bracket - Pivot / Pin 7/8"	
65, 165, 168, 175, 178, 185, 188, 250, 265, 275, 565, 575	4	30/735-5	894208M91	Filetage / Thread :7/8"UNF A :7/8" B :7/8" L :665-950m
TE20, 35 Séries 100, 200 series (France, UK)	5	30/750-1		Avec chaine / With chain A :7/8" B :3/4" L :435-965m
240, 253, 263, 362, 365, 375, 390, 396, 398, 399, 698, 699, 2620, 2625, 2640, 2645, 2680, 2685, 2720, 2725	6	30/735-6	3380703M91	Filetage / Thread :1"UNF A :5/8" B :1" L :700-900m
	7	30/734-1	514992M2 + 195352M1	Pla support avec axe 5/8" Support plate with 5/8" shaft

Païres de stabilisateurs télescopiques / Telescopic stabilisers pair

Complet avec 2 tirants + sabts gauch & droit / Complete set with 2 stabilisers + LH & RH brackets

Tracteurs Tractors	Réf. Ref.	Fig.
TE20, 35, 133, 135, 142, 148, 152	30/740-33K	
65 ⇒ 178 (France, UK) Tropettes rondes Round trumpet	30/740-34K	
155 ⇒ 595 (France, UK) Tropettes carrées Square trumpet	30/740-35K	







Les références des pièces sont indicatives.
Nos pièces ne sont pas d'origine

Part numbers are quoted for reference purposes only.
Our parts and accessories are not original.



**STABILISATEURS
STABILISERS**

Pitons de stabilisateurs / Stabilisers pins

Tracteurs Tractors	Réf. Ref.	OEM	Ø piton Pin Ø	Ø filet Thread Ø	Fig.
TE20, 35	30/730-4	180859M1 + 897677M1	5/8"	7/16"	
133, 135, 140, 148	30/730-6	897647M1 + 897677M1	5/8"	7/16"	
Séries 100, 200, 500 series	30/730-1	646101M2 646102M2	7/8"	5/8"	
	30/730-2	824332M1	3/4"	3/4"	
	30/730-7	1808585M1	7/8"	3/4"	
	30/730-8	183617M1	7/8"	3/4"	
	30/730-3	893420M1	7/8"	3/4"	

Stabilisateurs rigides / Rigid stabilisers

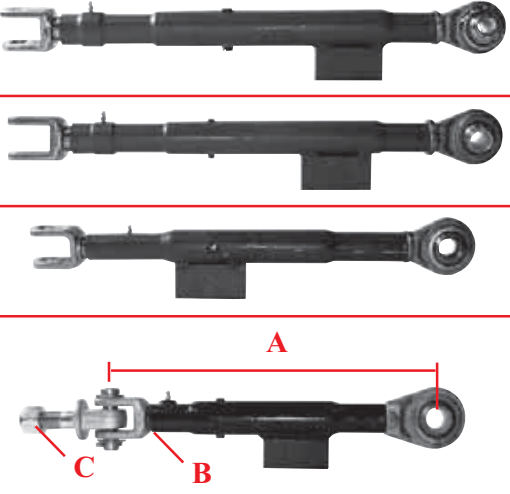
Tracteurs Tractors	Réf. Ref.	OEM	Fig.
353, 383, 387, 393, 397, 1007	30/740-44	3532084M93	
333, 353S, 363, 373, 377	30/740-45	3533205M92	
1014, 1024, 1114, 1134	30/740-46	3304616M91	
3050, 3060, 3065, 3075, 3085, 3095, 3120, 3125, 3635, 3645, 3655, 3670, 3690, 6110, 6120, 6130, 6140, 6150, 6160, 6170, 6180, 6190, 6235, 6245, 6255, 6260, 6265, 6270, 6280, 6290, 8110, 8120, 8130, 8140, 8150, 8160, 8210, 8230, 8240, 8250	30/740-28 A :405-502 B :M30x2 C :M24x3 30/740-38 A :400-445 B :M27x2 C :M24x2	3615707M93 3615042M2	

Les références des pièces sont indicatives.
Nos pièces ne sont pas d'origine

Part numbers are quoted for reference purposes only.
Our parts and accessories are not original.



**STABILISATEURS
STABILISERS**

Stabilisateurs à chaîne / Chain stabilisers

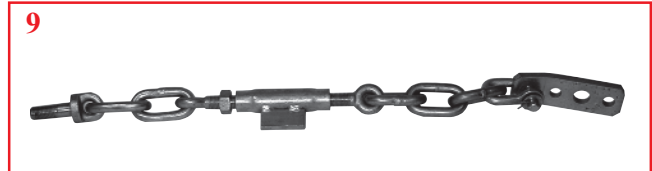
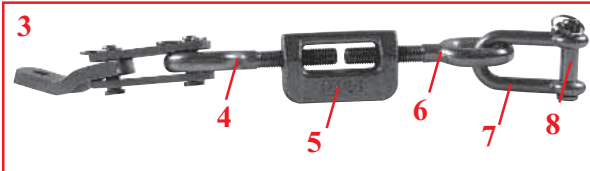

Tracteurs Tractors	Fig.	Réf. Ref.	OEM	Description
135, 230, 240, 550	1	30/740-5	1863260M93	Ensemble complet gauche ou droit Complete kit LH or RH
154, 174, 184, 194, 233, 234S, 253, 254, 263, 264, 273, 274	2	30/740-42	1424000M91	Ensemble complet gauche ou droit Complete kit LH or RH
265, 275, 285, 290, 340, 342, 362, 372N, 375, 382N, 390, 565, 575, 590, 675, 690, 1200	3	30/740-6	1661406M91	Ensemble complet gauche ou droit Complete kit LH or RH
	4	30/743-6	1661409M1	Oeillet fût droit Eyebolt RH
	5	30/744-4	1661411M1	Tendeur Turnbuckle
	6	30/746-3	1661408M1	Oeillet fût gauche Eyebolt LH
	7	30/747-2	1860594M1	Manivelle Shackle
	8	30/758-3	893567M1 3582662M1	Chvilin Clevis pin
283, 284, 293, 294	9	30/740-43	1424008M91	Ensemble complet gauche ou droit Complete kit LH or RH
Séries 100, 200 (France) series	10	30/740-37	907555M91	Ensemble complet gauche ou droit Complete kit LH or RH
1104	11	30/740-39	1824418M92	Ensemble complet gauche ou droit Complete kit LH or RH

Les références des pièces sont indicatives.
Nos pièces ne sont pas d'origine

Part numbers are quoted for reference purposes only.
Our parts and accessories are not original.



**TIRANTS DE RELEVAGE
LEVELLING BOX**

Standard / Standard duty



	1	2	3	4
Tracteurs Tractors	Fourche gauche Yoke LH	Suspente droite Level. box assy RH	Arbre Shaft	Fourreau Fork
TE20	30/759-1 (1-1) (182554M92, 8521)	30/760-1 (2-1) (180854M91, 4002)	30/761-3 (897681M2, 4297) 14 ³ / ₈ "x 3/4"UNC	30/762-1 (4-1) (890674M1, 4008) 9 ¹ / ₂ "x 3/4"UNC
35	30/759-1 (1-1) (182554M92, 8521) 30/759-3 (1-2) (826410M92) 10 ⁵ / ₈ "x 3/4"- 5/8"	30/760-2 (2-1) (182642M94)	30/761-1 (185220M1, 182641M1, 3107671M1) 10 ¹ / ₈ "x 3/4"UNC	30/762-2 (4-1) (184358M1, 182391M1) 14"x 3/4"UNC
65, 765 Bas dégagement Low clearance	30/759-4 (1-2) (1660372M91, 897683M92) 15"x 3/4"- 5/8"	30/760-3 (2-1) (184347M93)	30/761-2 (1660375M1, 184354M1, 897680M2) 12"x 3/4"UNC	
65, 765 Haut dégagement High clearance		30/760-4 (2-1) (184346M93)	30/761-3 (184353M1, 897681M2, 907980M1, 1862063M1) 14 ³ / ₈ "x 3/4"UNC	
133, 135, 140, 145, 148, 158 Rous / Wheels 11x28	30/759-2 (1-1) (1884720M1) 30/759-3 (1-2) (826410M92) 10 ⁵ / ₈ "x 3/4"- 5/8"	30/760-5 (2-1) (888628M91, 897658M92, 1884342M92)	30/761-1 (185220M1, 182641M1, 3107671M1) 10 ¹ / ₈ "x 3/4"UNC	30/762-3 (4-1) (897659M1) 13 ¹ / ₄ "x 3/4"UNC
133, 135, 140, 148, 152 Rous / Wheels 11x32 230, 235, 240, 245, 250, 340, 550	30/759-4 (1-2) (1660372M91, 897683M92) 15"x 3/4"- 5/8"	30/760-6 (2-1) (897678M93, 1660373M92)	30/761-2 (1660375M1, 184354M1, 897680M2) 12"x 3/4"UNC	
155, 158, 165, 168, 185, 188, 240, 250, 255, 260, 340, 560		30/760-7 (2-1) (897679M94, 906309M94)	30/761-3 (184353M1, 897681M2, 907980M1, 1862063M1) 14 ³ / ₈ "x 3/4"UNC	

Les références des pièces sont indicatives.
Nos pièces ne sont pas d'origine

Part numbers are quoted for reference purposes only.
Our parts and accessories are not original.



"THE RELIABLE SERVICE"



TIRANTS DE RELEVAGE LEVELLING BOX

Pièces pour tirants standards / Standard duty levelling box parts

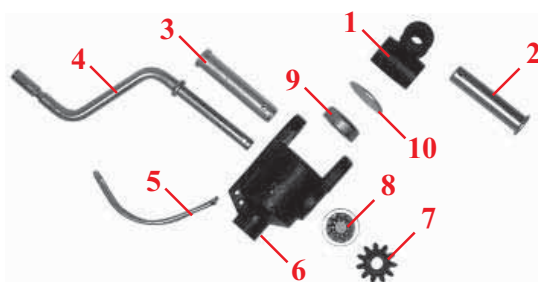

Réf. Ref.	OEM	Fig.	Description	Applications
30/757-1	897660M1, 1884376M1	1	Croisibn / <i>Knuckle</i>	Arbe / <i>Shaft 3/4"</i>
30/758-1	376399X1, 180860M1	2	Axe / <i>Clevis pin Ø/8"</i>	
30/758-1	376399X1, 180860M1	3	Axe / <i>Clevis pin Ø/8"</i>	
30/768-1	1662382M1, 181349M1	4	Manivèl / <i>Handle</i>	Tous modèles / <i>All models</i>
30/769-1	193092M1	5	Ressort de retenè / <i>Spring clip</i>	
30/766-1	193181M1, 181344M2	6	Boitier / <i>Box 3/4"</i>	Arbe / <i>Shaft 3/4"</i>
30/767-1	181345M2	7	Pignon à dentre coniq <i>Coned thread gear</i>	Tous modèles / <i>All models</i>
30/765-1	195457M1	9	Robent / <i>Bearing 3/4"</i>	Arbe / <i>Shaft 3/4"</i>
30/763-1	195644M1	10	Pastil / <i>Expansion plug</i>	Tous modèles / <i>All models</i>

Pièces pour tirants renforcés / Heavy duty levelling box parts

Réf. Ref.	OEM	Fig.	Description	Applications
30/757-2	897653M2	1	Croisibn / <i>Knuckle</i>	Arbe / <i>Shaft 1"</i>
30/758-2	893568M1, 1694025M1	2	Axe / <i>Clevis pin Ø/8"</i>	
30/758-3	893567M1, 3582662M1	3	Axe / <i>Clevis pin Ø/4"</i>	
30/768-1	1662382M1, 181349M1	4	Manivèl / <i>Handle</i>	Tous modèles / <i>All models</i>
30/769-1	193092M1	5	Ressort de retenè / <i>Spring clip</i>	
30/766-2	893561M1, 897652M1, 1860829M2	6	Boitier / <i>Box 1"</i>	Arbe / <i>Shaft 1"</i>
30/767-1	181345M2	7	Pignon à dentre coniq <i>Coned thread gear</i>	Tous modèles / <i>All models</i>
30/767-6	183631M1		Pignon à dentre droite <i>Straight thread gear</i>	Montage franqis / <i>French fitting</i>
30/765-4	1x831263M1+ 2x183630M1	8+9	Robent + rondèls <i>Bearing + ring</i>	Arbe / <i>Shaft 1"</i>
30/763-1	195644M1	10	Pastil / <i>Expansion plug</i>	Tous modèles / <i>All models</i>

Les références des pièces sont indicatives.
Nos pièces ne sont pas d'origine

Part numbers are quoted for reference purposes only.
Our parts and accessories are not original.



**TIRANTS DE RELEVAGE
LEVELLING BOX**

Renforcés / Heavy duty



	1	2	3	4
Tracteurs Tractors	Fourche gauche Yoke LH	Suspente droite Level. box assy RH	Arbre Shaft	Fourreau Fork
65, 165, 765 Dégagement standard / <i>Standard clearance</i>	30/759-7 (893562M91, 897655M92) 15 ³ / ₈ "x 1" 3/4"	30/760-11 (2-1) (1884760M94)	30/761-7 (897650M1) 13"x 1"UNF	30/762-4 (4-1) (893405M3) 12 ³ / ₄ "x 1"UNF
65, 165, 765 Haut dégageant / <i>High clearance</i> 175 178 (⇒ 746013) 250, 260, 265, 275, 565	30/759-7 (893562M91, 897655M92) 15 ³ / ₈ "x 1" 3/4"	30/760-12 (2-1) (1887372M91, 893570M92, 897649M95)	30/761-8 (893564M1, 1860833M1, 1860840M1, 1863885M1) 14 ³ / ₄ "x 1"UNF	30/762-4 (4-1) (893405M3) 12 ³ / ₄ "x 1"UNF
168, 175, 178 (746014 ⇒), 185, 188, 265, 275, 365, 375, 390, 575, 590	30/759-8 (1863057M91) 11 ³ / ₄ "x 1" 3/4"	30/760-13 (2-2) (1863053M94, 1693987M94)	30/761-9 (1863054M1) 11 ³ / ₈ "x 1"UNF	30/762-5 (4-2) (1861392M3) 16 ¹ / ₄ "x 1"UNF
185, 188	30/759-9 (1863888M91) 14 ¹ / ₈ "x 1" 3/4"	30/760-14 (2-2) (1863884M94)	30/761-8 (893564M1, 1860833M1, 1860840M1, 1863885M1) 14 ³ / ₄ "x 1"UNF	30/762-6 (4-2) (1863886M2) 16 ¹ / ₄ "x 1"UNF
265, 275, 285, 290, 298, 375, 390, 575, 590, 690, 698, 699		30/760-15 (2-2) (1660438M92)		30/762-5 (4-2) (1861392M3) 16 ¹ / ₄ "x 1"UNF
350, 362, 365, 375, 382N, 390, 398, 399, 675, 690		30/760-21 (2-2) (1693985M94, 1682387M91)		
165, 185, 188 Montage français - Arbre à denture droite <i>French fitting - Straight thread shaft</i>			30/761-55 (1808152M1) 12"x 1"UNF	
165, 185, 188, 285			30/761-48 (1808327M91) 14 ¹ / ₈ "x 1"UNF	
165, 178			30/761-50 (964672M91) 15 ⁹ / ₁₆ "x 1"UNF	
Vignerons / <i>Vineyards</i> 133 ⇒ 168			30/761-36 (961158M1)	30/762-40 (4-1) (969771M1)
3060, 3065, 3070, 3080, 3090 (⇒ P279011)	30/759-14 (3382728M92) 524m	30/760-22 (2-2) (3382727M93)	30/761-12 (3382726M2) 471m	30/762-11 (4-2) (3384035M3)

Les références des pièces sont indicatives.
Nos pièces ne sont pas d'origine

Part numbers are quoted for reference purposes only.
Our parts and accessories are not original.



**TIRANTS DE RELEVAGE
LEVELLING BOX**

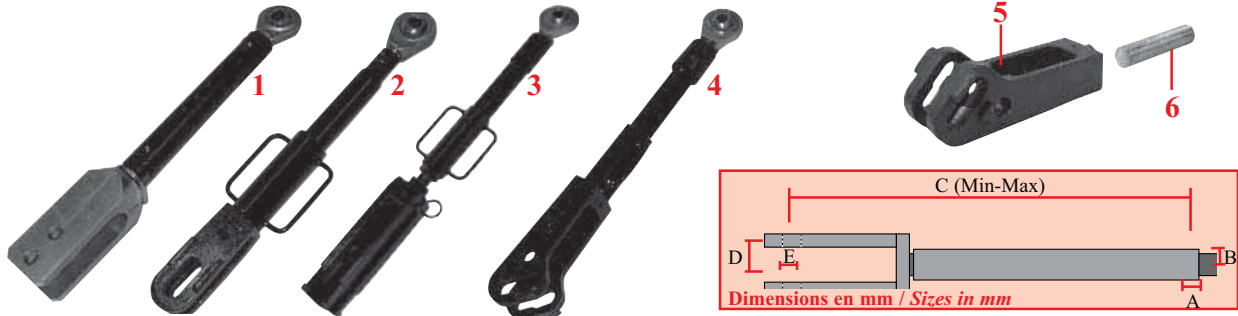

Tracteurs Tractors	Réf. Ref.	OEM	Arbre Levelling shaft	Fourreau Levelling fork	Fig.	A (mm)	B (mm)	C (mm)	D (mm)	E (mm)
2620, 2625, 2640, 2645, 2680, 2685, 2720, 2725	30/760-44	3380478M92, 1618260M93			1	25.4	48	595- 940	53	22
3050, 3060, 3065, 6110, 6120, 6130, 6235, 6245, 6255, 6260, 6265, 6270, 6280, 6290	30/760-45	3615055M3			2			550- 700	26	25.4
3050, 3060, 3065, 3070, 3075, 3080, 3085, 3090, 3095, 3115, 3120, 3125, 6110, 6120, 6130, 6140, 6150, 6160, 6170, 6180, 6190, 6235, 6245, 6255, 6260, 6265, 6270, 6280, 6290	30/760-42	3616223M92	30/761-46 (5) (3582541M2) M27x3 Lg 185m	30/762-46 (6) (3616224M2) M27x3	3	22	42	635- 835	32	22
3610, 3630, 3635, 3645, 3650, 3655, 3670, 3680, 8110, 8120, 8130, 8140, 8150	30/760-41	3581996M93	30/761-47 (5) (3581999M1) M36x3 - Lg 160m	30/762-49 (6) (3582000M1) M36x3 - D53m	4	25.4	48	750- 845	53	25.4
3645, 3655, 3670, 3690, 8110, 8120, 8130, 8140, 8150, 8160	30/760-40	3616478M91		30/762-48 (6) (3616209M1) M36x3 - D37m					37	

IT *Séries italiennes / Italian series*

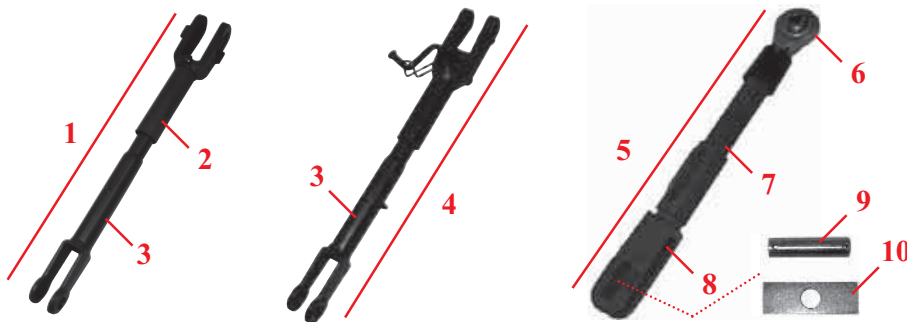

Tracteurs Tractors	Réf. Ref.	OEM	Fig.	Description
233, 253, 254, 264, 273, 274, 283, 284, 293, 294	30/760-62	3302117M93	1	Suspente gauche complète / Level box assy LH
	30/759-34	3300757M92	2	Fourch gauche / Yoke LH
	30/762-42	1423721M91, 3304340M91	3	Fourreau / Fork
	30/760-61	3301946M93	4	Suspente droite complète / Level box assy RH
1014, 1024, 1114, 1134	30/760-60	3301721M92	5	Suspente gauche ou droite complète / Level box assy LH or RH
	30/759-51	3301687M91	6	Rotin supérieure / Upper yoke
	30/761-51	3301676M92	7	Tb / Shaft
	30/762-43	3301681M91	8	Fourch inférieure / Lower fork
	30/758-19	3301711M2	9	Axe / Clevis pin
	30/758-20	3302770M1	10	Plaq / Plate

Les références des pièces sont indicatives.
Nos pièces ne sont pas d'origine

Part numbers are quoted for reference purposes only.
Our parts and accessories are not original.



**ALTERNATEURS
ALTERNATORS**

Tracteurs français, anglais & américains / French, UK & USA tractors

Tracteurs Tractors	OEM	Réf. Ref.		
TE20, FE35, 35, 65, 122, 130, 133, 135, 140, 145, 148, 152, 155, 158, 165, 168, 175, 178, 185, 188	LUCAS LRD101-C40 897104M92, 960022M1, 960023M1, 22703, 22733, 22780, 22791, 2871170, 2871182 12V-11A	62/910-1		
	Pôle / Pulley 0670321, 21820075, 31141408, 31141425, 731003M2, 731395M1, 3639592M1	30/59-1		
122, 130, 133, 135, 145, 148, 152, 155, 158, 165, 168, 178	LUCAS 24123 1895271M91, 1699871M1 LUCAS 24087 1897264M91 14V 34A	62/920-1 LUCAS 14V-34A		
	MOTOROLA 9AR2725F 1672859M1 14V 35A	62/920-17 ISKRA 14V 33 A		
	PARIS RHONE 906055M3, 3405393M2	62/920-80 VALEO 14V 40A Régletten séparé Separate regulator		

Alternateur multi-usage / Multi purpose alternator

Tracteurs Tractors	Réf. Ref.		
Sebn applications / <i>Various apps</i> Séries 100 & 00 series Avec pôle et ventiaten / <i>With pulley and fan</i>	62/920-128 14V-36A		











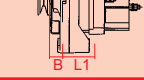
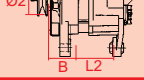

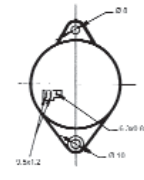
Les références des pièces sont indicatives.
Nos pièces ne sont pas d'origine

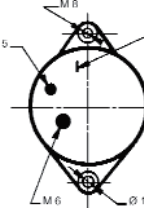
Part numbers are quoted for reference purposes only.
Our parts and accessories are not original.

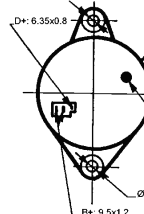

**ALTERNATEURS
ALTERNATORS**

Tracteurs français, anglais & américains / French, UK & USA tractors

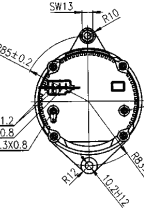
Tracteurs Tractors	OEM	Réf. Ref.		
230, 235, 245	LUCAS 24123 1699871M1, 1895271M91 LUCAS 24087 1897264M91 14V 34A	62/920-1 LUCAS 14V 34A		
	----- ISKRA 3823652M1 14V 45A	62/920-92 LUCAS 14V 55A		
	----- VALEO 3477851M91 14V 45A	62/920-81 VALEO 14V 55A		
240, 243, 253, 263, 275, 290	MOTOROLA 9AR2887F 1672859M1, 9AR2567F 1874616M1	62/920-82 VALEO 14V 55A		
	LUCAS 24123 1699871M1, 1895271M91 LUCAS 24087 1897264M91 14V 34A	62/920-17 ISKRA 3823652M1 14V 45A		
	----- VALEO 3477851M91 14V 45A	62/920-50 ISKRA 14V 65A		
245, 250, 255, 260, 265, 285, 298	Magneti Marelli 127A45 3698016M91, 3819355M91 14V 45A			

Les références des pièces sont indicatives.
Nos pièces ne sont pas d'origine

Part numbers are quoted for reference purposes only.
Our parts and accessories are not original.



"THE RELIABLE SERVICE"



**ALTERNATEURS
ALTERNATORS**

Tracteurs français, anglais & américains / French, UK & USA tractors

Tracteurs Tractors	OEM	Réf. Ref.		
340, 342, 352, 372	VALEO 3477851M91 14V 45A ----- LUCAS 24157 1897695M91 14V 55A -----	62/920-4 ISKRA 14V 55A	 Ø 68 A 10 B 37 L2 86	
	LUCAS 3478360M91, 3760524M91 3904254M91 14V 70A	62/920-11 LUCAS 14V 55A	 Ø 15 L2 82	
350, 355, 360, 362, 365, 375, 382, 390, 396, 398, 399	VALEO 3477851M91 14V 45A -----	62/920-10 ISKRA 14V 65A	 Ø 85 A 13 B 37 L2 90	
	MAGNETI MARELLI 3698015M91, 3698016M91, 3536264M1, 3819355M91 14V 45A -----	62/920-108 ISKRA 14V 70A	 Ø 17 L2 82	
	LUCAS 24157 1897695M91 14V 55A ----- LUCAS 3478360M91, 3760524M91 14V 70A			
550, 560, 565, 575, 590, 592, 595	LUCAS 24033 ----- LUCAS 23835 14V 55A -----	62/920-92 LUCAS 14V 55A	 Ø 15 L1 27	
	LUCAS 24124 1676705M91, 1699872M1 1895398M91 ----- LUCAS 1699878M91 -----	62/920-82 VALEO 14V 55A	 Ø 74 A 13 B 23 L1 27	
	MOTOROLA 1699602M92, 1618473M91 ----- MOTOROLA 9AR 2851K, 1674526M1 9AR 2566K, 1875955M1 14V 55A -----	62/920-17 ISKRA 14V 33A	 Ø 83 A 13 B 29 L1 27	
LUCAS 24124 1676705M91, 1699872M1, 1895398M91, 3474596M91 -----	62/920-50 ISKRA 14V 65A	 Ø 91 A 13 B 33 L1 27		
675, 690, 698	MOTOROLA 9AR 2851K 1674526M1, 2523075, 3467043M91 14V 55A			











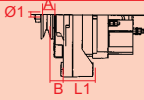
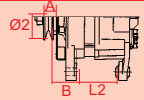

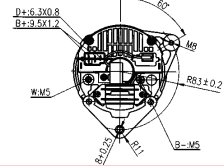

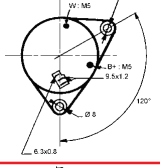
Les références des pièces sont indicatives.
Nos pièces ne sont pas d'origine

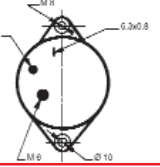
Part numbers are quoted for reference purposes only.
Our parts and accessories are not original.

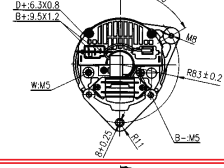

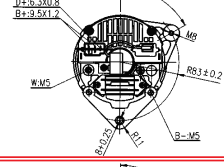
**ALTERNATEURS
ALTERNATORS**

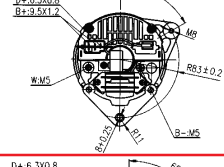
Tracteurs français, anglais & américains / French, UK & USA tractors

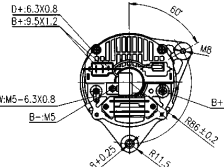
Tracteurs Tractors	OEM	Réf. Ref.										
698 T, 699	LUCAS 24157 1897695M91 14V 55A ----- MOTOROLA 9AR 5092 1643314M91	62/920-4 ISKRA 14V 55A										
			<table border="1"><tr><th>Ø</th><th>A</th><th>B</th><th>L2</th></tr><tr><td>68</td><td>10</td><td>37</td><td>86</td></tr></table>	Ø	A	B	L2	68	10	37	86	
		Ø	A	B	L2							
		68	10	37	86							
62/920-11 LUCAS 14V 55A												
	<table border="1"><tr><th>Ø</th><th>A</th><th>B</th><th>L2</th></tr><tr><td>15</td><td></td><td></td><td>82</td></tr></table>	Ø	A	B	L2	15			82			
Ø	A	B	L2									
15			82									
1004	LUCAS 24124 1895398M91, 3474596M91 ----- LUCAS 24157 1897695M91 14V 55 A	62/920-92 LUCAS 14V 55A										
			<table border="1"><tr><th>Ø</th><th>A</th><th>B</th><th>L2</th></tr><tr><td>15</td><td></td><td></td><td>27</td></tr></table>	Ø	A	B	L2	15			27	
		Ø	A	B	L2							
		15			27							
62/920-4 ISKRA 14V 55A												
	<table border="1"><tr><th>Ø</th><th>A</th><th>B</th><th>L2</th></tr><tr><td>68</td><td>10</td><td>37</td><td>86</td></tr></table>	Ø	A	B	L2	68	10	37	86			
Ø	A	B	L2									
68	10	37	86									
1200	LUCAS 24157 2871609, 2871621, 1447109M91, 1897695M91 14V 55A	62/920-4 ISKRA 14V 55A										
			<table border="1"><tr><th>Ø</th><th>A</th><th>B</th><th>L2</th></tr><tr><td>68</td><td>10</td><td>37</td><td>86</td></tr></table>	Ø	A	B	L2	68	10	37	86	
Ø	A	B	L2									
68	10	37	86									
1250 (UK)	LUCAS 2871A109, 2871A122 1447312M91	62/920-10 ISKRA 14V 65A										
			<table border="1"><tr><th>Ø</th><th>A</th><th>B</th><th>L2</th></tr><tr><td>85</td><td>13</td><td>37</td><td>90</td></tr></table>	Ø	A	B	L2	85	13	37	90	
Ø	A	B	L2									
85	13	37	90									
		62/920-108 ISKRA 14V 70A										
			<table border="1"><tr><th>Ø</th><th>A</th><th>B</th><th>L2</th></tr><tr><td>17</td><td></td><td></td><td>82</td></tr></table>	Ø	A	B	L2	17			82	
Ø	A	B	L2									
17			82									

Les références des pièces sont indicatives.
Nos pièces ne sont pas d'origine

Part numbers are quoted for reference purposes only.
Our parts and accessories are not original.

MF-402













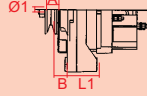
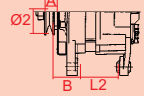

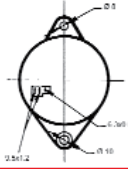

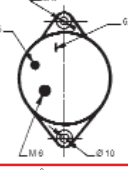

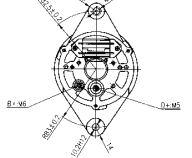
"THE RELIABLE SERVICE"

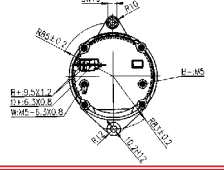

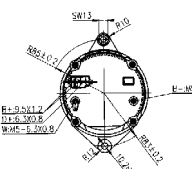
Ed.1 (07/04)

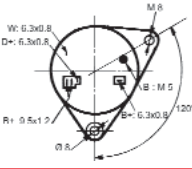
**ALTERNATEURS
ALTERNATORS**

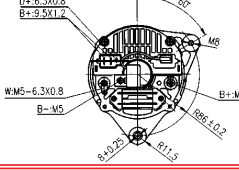
Tracteurs français, anglais & américains / French, UK & USA tractors

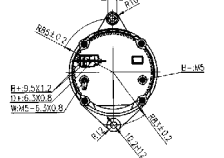







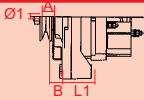
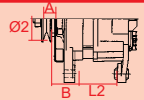

Tracteurs Tractors	OEM	Réf. Ref.		
2620, 2625, 2640, 2645, 2675, 2680, 2685, 2720, 2745	MOTOROLA 9AR 2887F, 1672859M1 9AR 2567F, 1874616M1 14V 35A ----- MOTOROLA 9AR 2851K, 1674526M1 9AR 2566K, 1875955M1 9AR 2944K, 3381352M91 2523075, 3467043M91 14V 55 A	62/920-1 LUCAS 14V-34A		
		62/920-92 LUCAS 14V 55A		
		62/920-17 ISKRA 14V 33A		
		62/920-50 ISKRA 14V 65A		
3050, 3060, 3065, 3070, 3075, 3080, 3090	MOTOROLA 2523075 3467043M91 14 V 55 A ----- VALEO 2541130 3581387M1, 3619490M00 14 V 70A ----- VALEO 2541131 3581388M1, 3619489M12 14 V 70A ----- VALEO 2541713 3618907M1 14 V 70A	62/920-50 ISKRA 14V 65A		
		62/920-74 VALEO 14V 70A		
3085, 3095, 3115, 3120, 3125, 3635, 3645, 3655, 3670, 3680, 3690	VALEO 2541290 3582821M1 14 V 70A ----- VALEO 2541712 3618906M1	62/920-108 ISKRA 14V 70A		
		62/920-50 ISKRA 14V 65A		

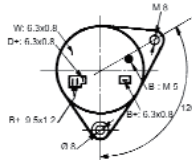
Les références des pièces sont indicatives.
Nos pièces ne sont pas d'origine

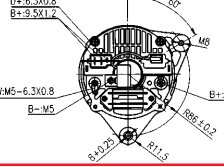
Part numbers are quoted for reference purposes only.
Our parts and accessories are not original.

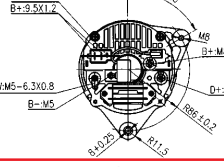

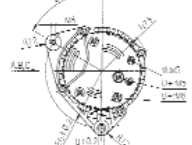
**ALTERNATEURS
ALTERNATORS**

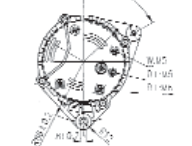
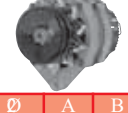
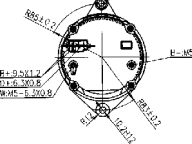
Tracteurs français, anglais & américains / French, UK & USA tractors				
Tracteurs Tractors	OEM	Réf. Ref.		
4215, 4220, 4225, 4235, 4240, 4245, 4255, 4260, 4265, 4270, 4315, 4320, 4325, 4335, 4345, 4355, 4360, 4365, 4370	Magnet Marel 3536264M1, 3698016M91 3819355M91 14 V 45A ----- MAGNETI MARELLI 3760524M91, 3904254M91 14 V 70A ----- ISKRA AAK3350 3823652M1 14 V 45A ----- ISKRA AAK3354 3823653M1 14 V 80 A ----- ISKRA AAK5189 3823654M2 14 V 120A	62/920-74 VALEO 14V 70A		 W: 6.3x0.8 D: 6.3x0.8 R: 0.8x1.2 E: 6.3x0.8 / 120°
		62/920-108 ISKRA 14V 70A		 D: 6.3x0.8 E: 9.5x1.2 WMS: 6.3x0.8 B: M5 R: 0.8x1.2 R1: 1.5
		62/920-155 ISKRA 14V 80A		 D: 6.3x0.8 E: 9.5x1.2 WMS: 6.3x0.8 B: M5 R: 0.8x1.2 R1: 1.5
		62/920-156 ISKRA 14V 120A Sans pôle <i>Less pulley</i>		 D: 6.3x0.8 E: 9.5x1.2 WMS: 6.3x0.8 B: M5 R: 0.8x1.2 R1: 1.5
		62/920-132 VALEO 14V 120A		 D: 6.3x0.8 E: 9.5x1.2 WMS: 6.3x0.8 B: M5 R: 0.8x1.2 R1: 1.5
6120, 6130, 6140, 6150	VALEO 2541713 3618907M1 14 V 70A ----- VALEO 3714922M1 ----- Magnet Marel A127 IR 3777677M1 14 V 120A	62/920-50 ISKRA 14V 65A		 D: 6.3x0.8 E: 9.5x1.2 WMS: 6.3x0.8 B: M5 R: 0.8x1.2 R1: 1.5











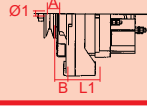
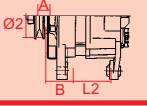

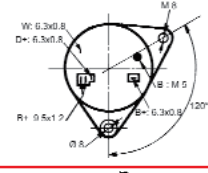

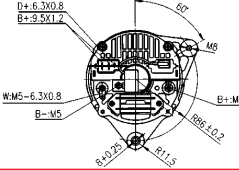

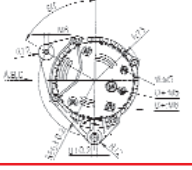
Les références des pièces sont indicatives.
Nos pièces ne sont pas d'origine

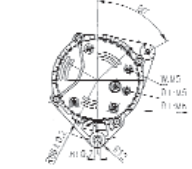
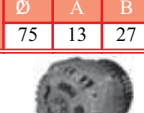
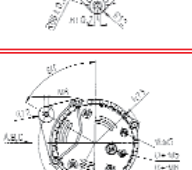
Part numbers are quoted for reference purposes only.
Our parts and accessories are not original.

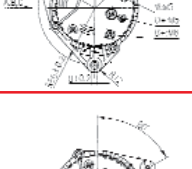

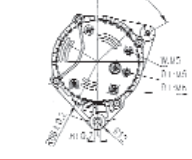
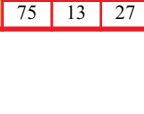
**ALTERNATEURS
ALTERNATORS**

Tracteurs français, anglais & américains / French, UK & USA tractors

Tracteurs Tractors	OEM	Réf. Ref.		
6160, 6170, 6180, 6190, 6235, 6245, 6255, 6260, 6265, 6270, 6280, 6290, 8210, 8220	Magneti Marell 3714944M1 14 V 70 A	62/920-74 VALEO 14V 70A		
	ISKRA AAK3355 3821974M91 14 V 80 A	62/920-108 ISKRA 14V 70A		
	VALEO 437195-439279 3780634M1 14 V 120A			
8110, 8120, 8130, 8140, 8150, 8160	ISKRA 3788017M91 14 V 120A	62/920-156 ISKRA 14V 120A Sans pôle Less pulley		
	VALEO 2641712 3618906M1	62/920-132 VALEO 14V 120A		
VALEO 2541714 3618908M1	62/920-156 ISKRA 14V 120A Sans pôle Less pulley			
Magneti Marell A127 IR 3777677M1 14 V 120A		62/920-132 VALEO 14V 120A		
VALEO 437195, 439279 3780634M1 14 V 120A			62/920-132 VALEO 14V 120A	
8240, 8250, 8260, 8270, 8280	ISKRA AAK-IV 3821976M92 14V 120A	62/920-132 VALEO 14V 120A		
	ISKRA AAK5195 3821978M92 14 V 120A			









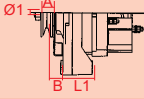
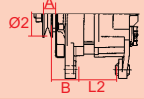

Les références des pièces sont indicatives.
Nos pièces ne sont pas d'origine

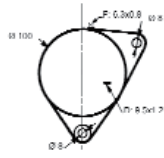
Part numbers are quoted for reference purposes only.
Our parts and accessories are not original.

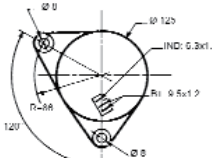

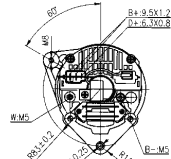
**ALTERNATEURS
ALTERNATORS**

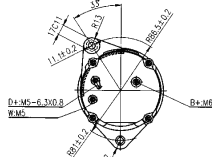
IT Tracteurs italiens / Italian tractors

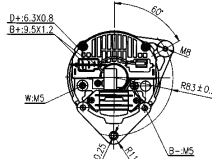
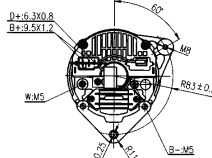
Tracteurs Tractors	OEM	Réf. Ref.		
134, 154, 174, 184, 194, 254	2871182 897104M92	62/910-1		
	Pole / Pulley 0670321, 21820075, 31141408, 31141425, 731003M2, 731395M1, 3639592M1	30/59-1		
134, 154, 164, 174, 184, 194	LUCAS 2871A105, 2871A120 2871A134, 2871619 3683183M91 ----- LUCAS 2871A118, 2871A141 1897695M91	62/920-5 LUCAS 14V 45A		
		62/920-24 ISKRA 14V 55A		
		62/920-69 ISKRA 14V 55A		
		62/920-4 ISKRA 14V 55A		
		62/920-10 ISKRA 14V 65A		











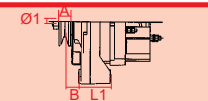
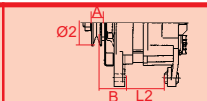

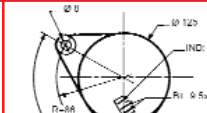
Les références des pièces sont indicatives.
Nos pièces ne sont pas d'origine

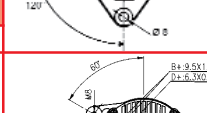
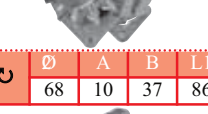
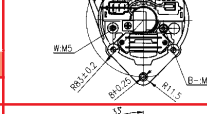
Part numbers are quoted for reference purposes only.
Our parts and accessories are not original.

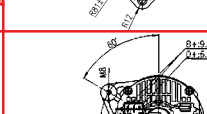
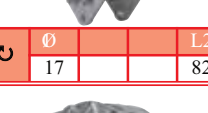
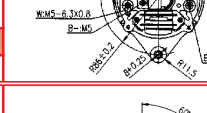

**ALTERNATEURS
ALTERNATORS**

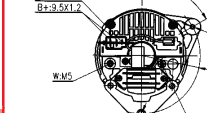
IT Tracteurs italiens / Italian tractors

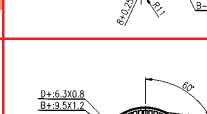
Tracteurs Tractors	OEM	Réf. Ref.		
233, 253, 263, 264	LUCAS 2871A120, 2871A134 3638814M1 14V 45A	62/920-5 LUCAS 14V 45A		
		62/920-24 ISKRA 14V 55A		
273, 274, 283, 284, 293, 294	LUCAS 2871A108, 2871A121, 2871A137, 2871D031, 2871624 1447706M91, 3476244M91	62/920-69 ISKRA 14V 55A		
		62/920-101 ISKRA 14V 70A		
		62/920-4 ISKRA 14V 55A		
234,244, 254.	LUCAS 2871A118, 2871A141, 1897695M91 14V 55 A ----- VALEO 477851M91 14V 45A	62/920-10 ISKRA 14V 65A		
273, 274, 283, 284, 293, 294	LUCAS 2871A118, 2871A141, 1897695M91 14V 55 A			
333,334,353, 354, 356, 363, 364, 366, 367, 373, 374, 376, 377, 383, 384, 387,393, 394, 396, 397	LUCAS 2871A118 2871A141, 1897695M91 14V 55 A ----- VALEO 477851M91 14V 45A ----- ISKRA 3547287M92 VALEO 3538541M91	62/920-108 ISKRA 14V 70A		
393, 394, 396, 397	ISKRA 3552682M92			
1007	LUCAS 2871A118, 2871A141, 1897695M91 14V 55 A ----- VALEO 3538541M91 ISKRA 3552682M92	62/920-108 ISKRA 14V 70A		
1014, 1024, 1114, 1134	VALEO 477851M91 14V 45A ----- LUCAS 2871A118 2871A141, 1897695M91 14V 55 A			











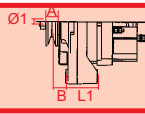
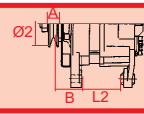

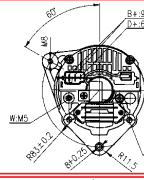

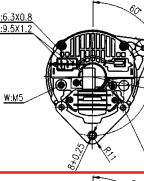
Les références des pièces sont indicatives.
Nos pièces ne sont pas d'origine

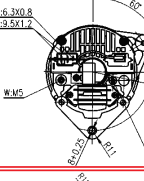
Part numbers are quoted for reference purposes only.
Our parts and accessories are not original.

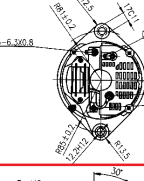

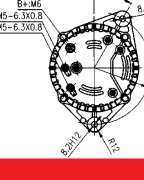
**ALTERNATEURS
ALTERNATORS**

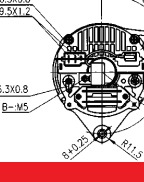
IT Tracteurs italiens / Italian tractors

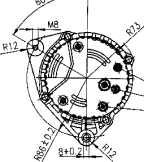
Tracteurs Tractors	OEM	Réf. Ref.		
1104	2871623	62/920-24 ISKRA 14V 55A	 Ø 68 A 10 B 37 L2 86	
2225, 2230, 2235	ISKRA 3552682M92	62/920-4 ISKRA 14V 55A	 Ø 68 A 10 B 37 L2 86	
3210, 3220, 3225, 3235, 3320 SP/FP/AP/GE	ISKRA 3547287M92 ----- VALEO 3477851M91 14 V 45 A	62/920-10 ISKRA 14V 65A	 Ø 85 A 13 B 37 L2 90	
3315, 3325, 3330, 3340, 3350, 3355	ISKRA 2.9439.420.0/1 14 V 65 A ----- ISKRA 2.9439.460.0/1 14 V 85 A	62/920-30 ISKRA 14V 65A	 Ø 17 L2 67	
		62/920-71 ISKRA 14V 95A	 Ø 17 L1 56	
Chargeurs télescopiques / Telescopic handlers				
8925, 8926, 8937, 8939	Magneti Marel 3760524M91, 3904254M91 14 V 70 A	62/920-108 ISKRA 14V 70A	 Ø 17 L2 82	
Fermec & Terex - Tracteurs industriels / Industrial tractors				
640B, 650B, 660B, 750, 760, 860, 865, 960, 965	6106495M91, 3519252M92 14 V 95 A	62/920-115 ISKRA 14V 95A	 Ø 2x61 A 10 B 37 L2 81	

Les références des pièces sont indicatives.
Nos pièces ne sont pas d'origine

Part numbers are quoted for reference purposes only.
Our parts and accessories are not original.



PIECES DE RECHANGE POUR ALTERNATEURS
SPARE PARTS FOR ALTERNATORS



Réf alternateur <i>Alternator ref.</i>	Fig. <i>Fig.</i>	Type <i>Type</i>	N° alternateur <i>Alternator N°</i>	Réf. régulateur <i>Régulator ref.</i>	Type <i>Type</i>	N° régulateur <i>Régulator N°</i>
ISKRA						
62/920-17	1	IA0095	11.201.095	62/919-19	AER 1503	11.125.198
62/920-50		IA0693	11.201.693	62/919-21	AER 1528	11.125.122
62/920-4		IA0301	11.201.301	62/919-17	AER 1535	11.125.139
62/920-10		IA0276	11.201.276	62/919-17 (⇒ 03/97) 62/919-3 (04/97 ⇒)	AER 1535 AER 1560	11.125.139 11.125.177
62/920-108		IA0810	11.201.810	62/919-3	AER 1560	11.125.177
62/920-155		AAK3354	11.201.983	62/919-43		11.125.205
62/920-156		AAK5189	11.201.970	62/919-44		16.908.611
62/920-24		IA0305	11.201.305	62/919-17 (⇒ 03/97) 62/919-3 (04/97 ⇒)	AER 1535 AER 1560	11.125.139 11.125.177
62/920-69		IA0405	11.201.405	62/919-21	AER 1528	11.125.122
62/920-101		IA0811	11.201.811	62/919-3	AER 1560	11.125.177
62/920-30		IA0463	11.201.463	62/919-21	AER 1528	11.125.122
62/920-71		IA0675	11.201.675	62/919-9		16.908.151
62/920-115		IA0881	11.201.881	62/919-44		16.908.611
LUCAS						
62/920-1	2	24087		62/919-80	UCB100	
62/920-92	3	23835		62/919-81	UCB109	
VALEO						
62/920-80	4	432982		62/919-33 <i>Séparé / Separated</i>	505E045	
62/920-81	5	432983		62/919-35	505E010	
62/920-82		432984		62/919-35	505E010	
	6			62/923-10 (1639363M91)	Bbc bis <i>Brush bloc</i>	

Les références des pièces sont indicatives.
Nos pièces ne sont pas d'origine

Part numbers are quoted for reference purposes only.
Our parts and accessories are not original.



PIECES DE RECHANGE POUR DYNAMO LUCAS
SPARE PARTS FOR LUCAS DYNAMO

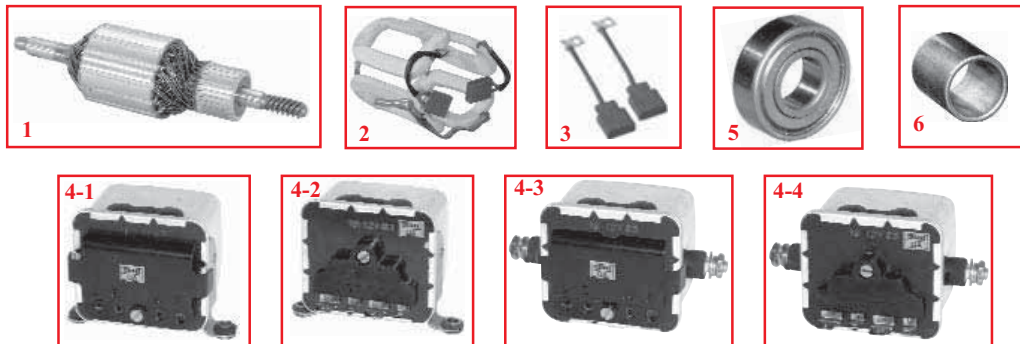
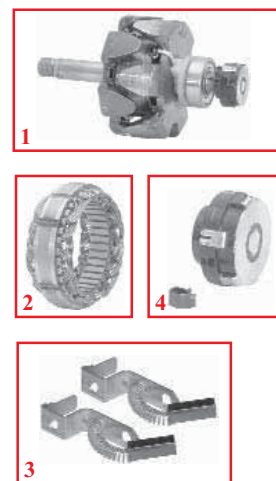

Fig.	1	2	3	4	5	6
Dynamo Dynamo	Induit Armature	Inducteur Field coil	Jeu de balais Brush set	Regulateur Regulator	Roulement Bearing	Coussinet Bush
62/910-1 C40A 22791 / LRD 101 2871182	62/911-2 (C40A, UWB 102, 1632735M1)	62/912-1 (A) (C39P, UVB 104, 227291)	62/913-1 (A) (C39P, USB 103, 227305)	62/919-1 (4-1) A visser / Screw type (NCB 113, 2872621)	62/915-1 (UTB 107)	62/914-1 (UTB 110)
				62/919-2 (4-2) Lraar (NCB 118, 2872637)		
		62/912-2 (C40A, UVB 102, 1632932M91)	62/913-2 (C40A, USB 104, 1024034M91)	62/919-4 (4-3) A visser / Screw type (NCB 112, 2872631)		
				62/919-5 (4-4) Lraar (NCB 119, 2872635)		

(A) Pièces pour premières dynamos C39P 22259 (Perkins 31170) / Parts for early C39P dynamo 22259 (Perkins 31170)

PIECES DE RECHANGE POUR ALTERNATEURS LUCAS
SPARE PARTS FOR LUCAS ALTERNATORS

Fig.	1	2	3	4
Alternateur Alternator	Rotor Rotor	Stator Stator	Jeu de balais Brush set	Anneau Slip ring
62/920-1 A115-34, 24087, LRA 361, 1897264M91			62/923-1 (A) (16 ACR, ULB 110, 1887426M1)	62/925-1 (A) (16 ACR, UAB 104, 1887421M1)
			62/923-2 (A115-34, ULB 105, 1895352M1)	
62/920-8 A133-55, 24204, LRA 380, 1895398M91			62/923-1 (B) (23 ACR, ULB 110, 1887426M1)	62/925-1 (B) (23 ACR, UAB 104, 1887421M1)
			62/923-2 (A133-55, ULB 105, 1895352M1)	
62/920-11 A127-55, 24157, LRA 460, 1897695M91	62/921-8 (UEB 100, 1897702M91)	62/922-11 (UIB 100, 1897705M1)		
62/920-4 A115-45, 24065, LRA 583, 2871A120			62/923-1 (C) (18 ACR, ULB 110, 1887426M1)	62/925-1 (C) (18 ACR, UAB 104, 1887421M1)
			62/923-2 (A115-45, ULB 105, 1895352M1)	
62/920-9 A133-55, 23996, LRA 360, 2871A109			62/923-2 (ULB 105, 1895352M1)	



(A) Pièces pour alternateurs 16 ACR (34 A.) 23865, 24022 et 24123 / Parts for 16 ACR (34 A.) Alternators 23865, 24022 & 24123

(B) Pièces pour alternateurs 18 ACR (43 A.) 23617, 23622 et 23737 / Parts for 18 ACR (43 A.) Alternators 23617, 23622 & 23737











(C) Pièces pour alternateurs 23 ACR (55 A.) 23835, 23862, 24015, 24033 et 24124
Parts for 23 ACR (55 A.) Alternators 23835, 23862, 24015, 24033 & 24124

Les références des pièces sont indicatives.
Nos pièces ne sont pas d'origine

Part numbers are quoted for reference purposes only.
Our parts and accessories are not original.



**DEMARREURS
STARTERS**









Tracteurs Tractors	Moteur Engine	OEM	Réf. Ref.	A x B 	Z	L	
TE20, FE35	Standard Pétrole Petrol	LUCAS 25038 M35G/1	62/930-1		2 x 127 12 V	9 z 1,8 kW	168 m
TEF20, 30, 35	Standard 20C, 23C	LUCAS 26071, 26133, 26278, LRS157	62/930-3		3 x 146 12 V	11 z 2,8 kW	224 m
35, 133	A3.144	LUCAS 26154, 26220, 26264, 26365, 26411, 26412, 27432, 27470, 27540, 27571, LRS190	62/930-4		3 x 146 12 V	10 z 2,7 kW	220 m
35	A3.152	887057M2, 898090M1, 1680065M3, 1691805M2, 1868283M2, 1893611M91, 3597371M2, 3597426M2	62/930-90 ISKRA		3 x 146 12 V	10 z 2,7 kW	223 m
65	A4.192	----- PARIS-RHONE 1808449M2 =95963J 968296M1 =D11E84					
65	A4.203	----- DUCELLIER 968856M1, 1871433M2 =6232A	62/930-87 ISKRA		3 x 146 12 V	10 z 2,8 kW	240 m
133, 134, 135, 140, 145, 148, 152, 154	AD3.152	----- MAGNETI MARELLI 3763363M92 =27582D	62/930-10		3 x 146 12 V	10 z 3,5 kW	254 m
164	AT3.152	BOSCH 964382M1, 3542186M91					
65, 155, 158, 165	AD4.203	----- ISKRA 3546390M91, 3650746M91					
165, 174	A4.212	LUCAS 26271, 26295, 26358, 26410, 26413, 26414, 27539, 27433, 27572, LRS137, LRS162, LRS232, LRS306 888346M1, 1680064M1, 1860093M2, 1868285M3, 3597372M2	62/930-80 ISKRA		3 x 127 12 V	10 z 2,8 kW	238 m
168, 174, 175, 184	A4.236	----- PERKINS 1447301M91, 1447698M1, 1691806M1, 28733006, 2873D002, 2873B055	62/930-11		3 x 127 12 V	10 z 3 kW	260 m
		----- PARIS RHONE 909971M2					
185, 188, 194	A4.248	----- MAGNETI MARELLI 3539390M91, 3763362M92, 27583 ----- ISKRA 3546391M92 ----- BOSCH 3542187M91	62/930-5		3 x 127 12 V	10 z 3,5 kW	254 m

Les références des pièces sont indicatives.
Nos pièces ne sont pas d'origine

Part numbers are quoted for reference purposes only.
Our parts and accessories are not original.



**DEMARREURS
STARTERS**









Tracteurs Tractors	Moteur Engine	OEM	Réf. Ref.	 A x B	Z	L
230, 233, 234, 235, 240, 245, 250, 253, 254, 255	AD3.152	LUCAS 26154, 26220, 26264, 26365, 26411, 26412, 27432, 27470, 27540, 27571, LRS190 887057M2, 898090M1, 1680065M3, 1691805M2, 1868283M2, 1893611M91, 3597371M2, 3597426M2	62/930-4	3 x 146  12 V	10 z 2,7 kW	220 m
			62/930-90 ISKRA	3 x 146  12 V	10 z 2,7 kW	223 m
			62/930-87 ISKRA	3 x 146  12 V	10 z 2,8 kW	240 m
253, 263, 264	AT3.152	PARIS-RHONE 1808449M2 =95963J 968296M1 =D11E84	62/930-10	3 x 146  12 V	10 z 3,5 kW	254 m
260	AD4.203	DUCELLIER 968856M1, 1871433M2 =6232A				
			MAGNETI MARELLI 3763363M92 =27582D	BOSCH 964382M1, 3542186M91	ISKRA 3546390M91, 3650746M91	
265, 273, 274, 275, 283, 284	A4.236	LUCAS 26271, 26295, 26358, 26410, 26413, 26414, 27539, 27433, 27572, LRS137, LRS162, LRS232, LRS306 888346M1, 1680064M1, 1860093M2, 1868285M3, 3597372M2	62/930-80 ISKRA	3 x 127  12 V	10 z 2,8 kW	238 m
285, 290, 293, 294	A4.248	PERKINS 1447301M91, 1447698M1, 1691806M1, 28733006, 2873D002, 2873B055	62/930-11	3 x 127  12 V	10 z 3 kW	260 m
285, 295	A4.318	PARIS RHONE 909971M2	62/930-5	3 x 127  12 V	10 z 3,5 kW	254 m
275E, 290E	A4.41	MAGNETI MARELLI 3539390M91, 3763362M92, 27583				

Les références des pièces sont indicatives.
Nos pièces ne sont pas d'origine

Part numbers are quoted for reference purposes only.
Our parts and accessories are not original.



**DEMARREURS
STARTERS**







Tracteurs Tractors	Moteur Engine	OEM	Réf. Ref.	 A x B Z L
333, 334, 340, 342, 350, 353, 354	AD3.152	LUCAS 26154, 26220, 26264, 26365, 26411, 26412, 27432, 27470, 27540, 27571, LRS190 887057M2, 898090M1, 1680065M3, 1691805M2, 1868283M2, 1893611M91, 3597371M2, 3597426M2 ----- PARIS-RHONE 1808449M2 =95963J 968296M1 =D11E84 -----	62/930-4	3 x 146  12 V 2,7 kW 10 z 220 m
			62/930-90 ISKRA	3 x 146  12 V 2,7 kW 10 z 223 m
352, 360, 363, 364, 366	AT3.152	DUCELLIER 968856M1, 1871433M2 =6232A ----- MAGNETI MARELLI 3763363M92 =27582D ----- BOSCH 964382M1, 3542186M91 ----- ISKRA 3546390M91, 3650746M91	62/930-87 ISKRA	3 x 146  12 V 2,8 kW 10 z 240 m
			62/930-10	3 x 146  12 V 3,5 kW 10 z 254 m
362, 365, 367, 372, 373, 374, 375, 376, 377, 383, 384	A4.236	LUCAS 26271, 26295, 26358, 26410, 26413, 26414, 27539, 27433, 27572, LRS137, LRS162, LRS232, LRS306 888346M1, 1680064M1, 1860093M2, 1868285M3, 3597372M2 ----- PERKINS 1447301M91, 1447698M1, 1691806M1, 28733006, 2873D002, 2873B055 -----	62/930-80 ISKRA	3 x 127  12 V 2,8 kW 10 z 238 m
393, 394, 396, 397, 398	AT4.236		62/930-11	3 x 127  12 V 3 kW 10 z 260 m
382, 390, 393, 394, 396, 397	A4.248	PARIS RHONE 909971M2 ----- MAGNETI MARELLI 3539390M91, 3763362M92, 27583 ----- ISKRA 3546391M92 ----- BOSCH 3542187M91	62/930-5	3 x 127  12 V 3,5 kW 10 z 254 m
399	A6.354			

Les références des pièces sont indicatives.
Nos pièces ne sont pas d'origine

Part numbers are quoted for reference purposes only.
Our parts and accessories are not original.

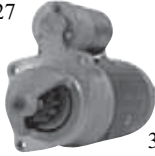

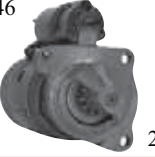
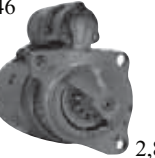
**DEMARREURS
STARTERS**









Tracteurs Tractors	Moteur Engine	OEM	Réf. Ref.	 A x B Z L	
375E, 390E	4.41	LUCAS 3763362M4	62/930-80 ISKRA	3 x 127 10 z  2,8 kW 12 V	238 m
		ISKRA 3821818M91 AZF4520	62/930-11	3 x 127 10 z  3 kW 12 V	260 m
396, 399	1006	LUCAS 3597372M2	62/930-5	3 x 127 10 z  3,5 kW 12 V	254 m
		MAGNETI MARELLI 3763362M2	62/930-180 ISKRA <i>avec réducteur with reducer</i>	3 x 127 10 z  3 kW 12 V	
550	AD3.152	LUCAS 26154, 26220, 26264, 26365, 26411, 26412, 27432, 27470, 27540, 27571, LRS190 887057M2, 898090M1, 1680065M3, 1691805M2, 1868283M2, 1893611M91, 3597371M2, 3597426M2	62/930-4	3 x 146 10 z  2,7 kW 12 V	220 m
		PARIS-RHONE 1808449M2 =95963J 968296M1 =D11E84	62/930-90 ISKRA	3 x 146 10 z  2,7 kW 12 V	223 m
560	AD4.203	DUCELLIER 968856M1, 1871433M2 =6232A	62/930-87 ISKRA	3 x 146 10 z  2,8 kW 12 V	240 m
		MAGNETI MARELLI 3763363M92 =27582D BOSCH 964382M1, 3542186M91 ISKRA 3546390M91, 3650746M91	62/930-10	3 x 146 10 z  3,5 kW 12 V	254 m

Les références des pièces sont indicatives.
Nos pièces ne sont pas d'origine

Part numbers are quoted for reference purposes only.
Our parts and accessories are not original.



**DEMARREURS
STARTERS**



Tracteurs Tractors	Moteur Engine	OEM	Réf. Ref.	 A x B Z L
565, 575, 675	A4.236	LUCAS 26271, 26295, 26358, 26410, 26413, 26414, 27539, 27433, 27572, LRS137, LRS162, LRS232, LRS306	62/930-80 ISKRA	3 x 127 10 z  238 m
590, 690	A4.248	888346M1, 1680064M1, 1860093M2, 1868285M3, 3597372M2		12 V 2,8 kW
592, 595, 698 1004, 1080, 1085	A4.318	PERKINS 1447301M91, 1447698M1, 1691806M1, 28733006, 2873D002, 2873B055	62/930-11	3 x 127 10 z  260 m
698T 1004T, 1007	AT4.236	PARIS RHONE 909971M2		12 V 3 kW
699 1014, 1024, 1100, 1104, 1114, 1200, 1250	A6.354	MAGNETI MARELLI 3539390M91, 3763362M92, 27583	62/930-5	3 x 127 10 z  254 m
1105, 1134, 1135	AT6.354	ISKRA 3546391M92 BOSCH 3542187M91		12 V 3,5 kW
2620, 2625, 2640, 2645, 2675	A6.354.4	LUCAS 27533	62/930-16 ISKRA	3 x 127 10 z  228 m
2680, 2685, 2705, 2720, 2725	AT6.354.4	LRS553 1618050M4		12 V 2,8 kW
3050, 3225	A4.236	LUCAS 1868285M3 =26410 3597372M2 ----- MAGNETI MARELLI 3763362M92	62/930-80 ISKRA	3 x 127 10 z  238 m
3065, 3070	AT4.236			3 x 127 10 z  260 m
3055, 3060, 3235	A4.248		12 V 3 kW	
3075	1004		3 x 127 10 z  254 m	
3080, 3090, 3630, 3650	AT6.354.4	LUCAS 27533	62/930-16 ISKRA	3 x 127 10 z  228 m
		LRS553 1618050M45		12 V 2,8 kW

Les références des pièces sont indicatives.
Nos pièces ne sont pas d'origine

Part numbers are quoted for reference purposes only.
Our parts and accessories are not original.



**DEMARREURS
STARTERS**

Tracteurs Tractors	Moteur Engine	OEM	Réf. Ref.				
3085, 3095, 3115	1006.6	LUCAS 27518, 27520, 27570, LRS161, LRS302, 1447732M1	62/930-38 ISKRA	3 x 127	10 z		
3120, 3125, 3635, 3645, 3655	1006.6T	MAGNETI MARELLI 3581576M3			237 m		
3670	620DS	PERKINS 2873001, 2873A102, 2873B056, 2873B071				12 V	2,8 kW
3680, 3690	612DS						
3315, 3325	903.27	4224325M91 PERKINS 2873A104	62/930-90 ISKRA	3 x 146	10 z		
				12 V	2,7 kW		
3330, 3340, 3350, 3355	1004	4224340M91 PERKINS 2873B072	62/930-80 ISKRA	3 x 127	10 z		
				12 V	2,8 kW		
4215	903.27	MAGNETI MARELLI 3763363M91	62/930-4	3 x 146	10 z		
					12 V	2,7 kW	
			62/930-90 ISKRA	3 x 146	10 z	233 m	
					12 V	2,7 kW	
4220	903.27T		62/930-87 ISKRA	3 x 146	10 z		
				12 V	2,8 kW		
			62/930-10	3 x 146	10 z		
				12 V	3,5 kW		

Les références des pièces sont indicatives.
Nos pièces ne sont pas d'origine

Part numbers are quoted for reference purposes only.
Our parts and accessories are not original.



**DEMARREURS
STARTERS**

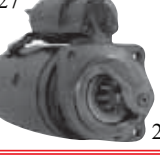

Tracteurs Tractors	Moteur Engine	OEM	Réf. Ref.	 A x B Z L
4225, 4235, 4240, 4245, 4255, 4265	1004		62/930-80 ISKRA	3 x 127 10 z  12 V 2,8 kW
4260, 4270	1006	MAGNETI MARELLI 3763362M94 ⇒ K37008	62/930-11	3 x 127 10 z  12 V 3 kW
4325, 4335, 4345, 4355, 4365	1004	ISKRA 3821818M91 AZF4520 K37009 ⇒	62/930-5	3 x 127 10 z  12 V 3,5 kW
4360, 4370	1006		62/930-180 ISKRA <i>avec réducteur</i> <i>with reducer</i>	3 x 127 10 z  12 V 3 kW
6120, 6130, 6140, 6150	1004	MAGNETI MARELLI 3763362M94	62/930-38 ISKRA	3 x 127 10 z  12 V 2,8 kW
6160, 6170, 6180, 6190	1006	MAGNETI MARELLI 3581576M3	62/930-180 ISKRA <i>avec réducteur</i> <i>with reducer</i>	3 x 127 10 z  12 V 3 kW
6235, 6245, 6255, 6265	1004	MAGNETI MARELLI 3781442M92 ISKRA 3821818M91 AZF4520	62/930-38 ISKRA	3 x 127 10 z  12 V 2,8 kW
6260, 6270, 6280, 6290	1006	MAGNETI MARELLI 3581576M3 ISKRA 3784890M1, 3823621M91 AZF4542	62/930-181 ISKRA <i>avec réducteur</i> <i>with reducer</i>	3 x 127 10 z  12 V 4,2 kW
8110, 8120, 8130	1006		62/930-38 ISKRA	3 x 127 10 z  12 V 2,8 kW
8140, 8150	620DS	MAGNETI MARELLI 3581576M3	62/930-38 ISKRA	3 x 127 10 z  12 V 2,8 kW
8160	634DS			3 x 127 10 z  12 V 2,8 kW

Les références des pièces sont indicatives.
Nos pièces ne sont pas d'origine

Part numbers are quoted for reference purposes only.
Our parts and accessories are not original.



**DEMARREURS
STARTERS**

Tracteurs Tractors	Moteur Engine	OEM	Réf. Ref.	 A x B Z L
8170, 8180	645DS	MAGNETI MARELLI 3777247M1 ----- ISKRA 3784889M2	62/930-44 ISKRA	3 x 127 10 z  243 m 12 V 3 kW
8210, 8220	1006	MAGNETI MARELLI 3581576M3 ----- ISKRA 3784890M1, 3823621M91 AZF4542	62/930-38 ISKRA	3 x 127 10 z  237 m 12 V 2,8 kW
			62/930-181 ISKRA <i>avec réducteur with reducer</i>	3 x 127 10 z  4,2 kW 12 V
8240 8250	620DS 634DS	MAGNETI MARELLI 3777247M1 ----- ISKRA 3784889M2	62/930-44 ISKRA	3 x 127 10 z  243 m 12 V 3 kW
8260	634DS	MAGNETI MARELLI 3581576M3 ⇒ K073010 ----- ISKRA 3784889M2 K073011 ⇒	62/930-38 ISKRA	3 x 127 10 z  237 m 12 V 2,8 kW
			62/930-44 ISKRA	3 x 127 10 z  243 m 12 V 3 kW
8270, 8280	645DS	MAGNETI MARELLI 3777247M1 ⇒ K071001 ----- ISKRA 3784889M2 K071002 ⇒	62/930-44 ISKRA	3 x 127 10 z  243 m 12 V 3 kW

Les références des pièces sont indicatives.
Nos pièces ne sont pas d'origine

Part numbers are quoted for reference purposes only.
Our parts and accessories are not original.

MF-418











"THE RELIABLE SERVICE"



Ed.1 (07/04)

**DEMARREURS
STARTERS**











Tracteurs <i>Tractors</i>	Moteur <i>Engine</i>	OEM	Réf. <i>Ref.</i>		
 Moissonneuses-batteuses / Combines					
206, 240, 307, 330	A4.236	LUCAS 1860093M2	62/930-80 ISKRA	3 x 127	10 z 238 m
430, 440, 487, 506	A4.248			12 V	 2,8 kW
507, 520, 525	A6.354	PERKINS 2873006 1447301M91	62/930-11	3 x 127	10 z 260 m
530, 800, 805, 810, 815	A6.354.4			12 V	 3 kW
560, 565, 660, 665, 820, 825, 830, 835, 840, 845	AT6.354			62/930-5	3 x 127
				12 V	 3,5 kW
 Chargeurs télescopiques / Telescopic handlers					
8925, 8926, 8937, 8939	1004.4	LUCAS 3597372M2 ----- MAGNETI MARELLI 3763362M92 ≈27583	62/930-80 ISKRA	3 x 127	10 z 238 m
				12 V	 2,8 kW
				62/930-11	3 x 127
				12 V	 3 kW
			62/930-5	3 x 127	10 z 254 m
				12 V	 3,5 kW

Les références des pièces sont indicatives.
Nos pièces ne sont pas d'origine

Part numbers are quoted for reference purposes only.
Our parts and accessories are not original.



**DEMARREURS
STARTERS**







Tracteurs Tractors	Moteur Engine	OEM	Réf. Ref.	 A x B Z 	 L
Tracteurs industriels / Industrial tractors					
20B, 20D, 20E, 20F, 30E, 30H	AD3.152		62/930-4	3 x 146 12 V  2,7 kW	10 z 220 m
40E	T3.152	LUCAS 3597371M2 ----- MAGNETI MARELLI 3763363M92 ≈27582D	62/930-90 ISKRA	3 x 146 12 V  2,7 kW	10 z 223 m
			62/930-87 ISKRA	3 x 146 12 V  2,8 kW	10 z 240 m
50	AD4.203		62/930-10	3 x 146 12 V  3,5 kW	10 z 254 m
50	A4.236		62/930-80 ISKRA	3 x 127 12 V  2,8 kW	10 z 238 m
50	A4.248	LUCAS 3597372M2 ----- MAGNETI MARELLI 3763362M92 ≈27583	62/930-11	3 x 127 12 V  3 kW	10 z 260 m
60	A4.236			3 x 127 12 V  3,5 kW	10 z 254 m
60	A4.248		62/930-5		
FERMEC & EREX 640B, 650B, 660B, 750, 760, 860, 960, 965	1004.4	3519400M92	62/930-82 ISKRA	3 x 12 12 V  3 kW	10 z 238 m

Les références des pièces sont indicatives.
Nos pièces ne sont pas d'origine

Part numbers are quoted for reference purposes only.
Our parts and accessories are not original.

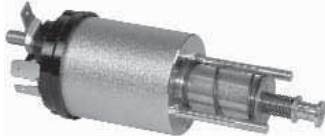

PIECES DE RECHANGES POUR DEMARREURS LUCAS - RELAIS
SPARE PARTS FOR LUCAS STARTER MOTOR - SOLENOID









Réf. Ref.	Type démarreur Starter type	N° Lucas Lucas N°	OEM	Illustration Illustration
62/940-1	M35G	76407, 76418	SRB 310	
62/940-36	M45G	76411, 76415, 76417, 76425, 76426, 76443, 76445, 76449, 76453, 76460, 76464, 76465, 76466, 76468, 76469, 76470, 76471, 76485, 76486, 76715, 76722, 76766, 76767, 76772, 76773, 76776	829958M1, 1865974M1, 2848201, 2848203, SRB 325	
62/940-4				
62/940-5	M45G	76458, 76474, 76490, 76498, 76538, 76712, 76727, 76794, 76808	TOB 100, TOB 151, TOB 153	
62/940-6	M45G	76755, 76763, 76786, 76796, 76800, 76803, 76815, 76816, 76820, 76821, 76823, 76824, 76826, 76827, 76837, 76850, 76852, 76855, 76885, 76891, 76892, 76895, 76896, 76897, 76899, 76902, 76908, 76961, 77034, 77035, 77058, 77157, 77160	1047083M91, 1632988M91, 1806219M1, 1889498M1, 1890038M1, 1893614M91, 3475771M91, TOB 109, TOB 113, TOB 121, TOB 134, TOB 162, TPB 107, TPB 109	
62/940-9	M50	76740, 76753, 76756, 76781, 76825, 76833, 76834, 76835, 76836, 76854, 76862, 76864, 76865, 76869, 76881, 76900, 76910, 76911, 76912, 76913, 76928, 76956, 77010, 77025, 77032, 77052	1094197M91, 1429483M91, 1887960M91, 1889779M1, 1893404M91, 1893707M91, 1894550M91, 3473937M91	
62/940-12	M127	77121, 77131, 77132, 77133, 77139, 77141, 77143	1897313M91, 3474587M1, TPB 104, TPB 111, TPB 116, TPB 118, TPB 119	
62/940-14	M127	77129, 77135, 77152	3473296M91, TPB 112, TPB 113, TPB 122	

Les références des pièces sont indicatives.
Nos pièces ne sont pas d'origine

Part numbers are quoted for reference purposes only.
Our parts and accessories are not original.



PIECES DE RECHANGES POUR DEMARREURS LUCAS - LANCEUR
SPARE PARTS FOR LUCAS STARTER MOTOR - DRIVE ASSEMBLY

Réf. Ref.	Type démarreur Starter type	OEM	Illustration Illustration	Description Description
62/939-3	M45G	292130, 60600341, TLB 117		11 dents - 6 cannelures droites <i>11 teeth - 6 straight splines</i>
62/939-5	M45G	3117750R91, 292124, 60600342, TLB 118		10 dents - 6 cannelures droites <i>10 teeth - 6 straight splines</i>
62/939-7	M45G	54246725, 54259688, TMB 105		10 dents - 3 cannelures <i>10 teeth - 3 splines</i>
62/939-8	M45G	1894395M91, 54247034, 60600024, TMB 120		10 dents - 12 cannelures <i>10 teeth - 12 splines</i>
62/939-12	M50	1888292M91, 1893713M91, 54244938, 54246285, 54246654, 60600066, TMB 100		10 dents - 12 cannelures Longueur=73 m <i>10 teeth - 12 splines Length = 73 mm</i>
62/939-13	M50	1052441M91, 54243781, 54246662, 60600050, TMB 102		10 dents - 12 cannelures Longueur=101 m <i>10 teeth - 12 splines Length = 101 mm</i>
62/939-15	M127	1897316M91, 3523401M91, 54268141, TNB 165		10 dents - 12 cannelures Longueur=73 m <i>10 teeth - 12 splines Length = 73 mm</i>
62/939-16	M127	3473804M91, 54268142, TNB 169		10 dents - 12 cannelures Longueur=101 m <i>10 teeth - 12 splines Length = 101 mm</i>

Les références des pièces sont indicatives.
Nos pièces ne sont pas d'origine

Part numbers are quoted for reference purposes only.
Our parts and accessories are not original.



PIECES DE RECHANGES POUR DEMARREURS LUCAS
SPARE PARTS FOR LUCAS STARTER MOTOR



Fig.	1	2	3	4
Type démarreur Starter type	Induit Armature	Inducteur Field coil	Balais Brush	Kit coussinets Bearing set
M45G	62/931-4 54255952 TIB 114 3 cannettes / splines	62/932-3 1015997M91 54266045 TEB 104 TEB 110 TEB 132	62/933-2 1012013M91 TAB 125	62/934-1 54243853
	62/931-3 54251818 TIB 113 6 cannettes / splines			
	62/931-5 1893410M91 54247379 TIB 108 12 cannettes / splines			
M50	62/931-6 1632931M1 54243849 TJB 107 3 cannettes / splines	62/932-4 1897291M91 54244973 54248227 54266463 TEB 103 TEB 129	62/933-3 1810743M91 54244979 54259517 TAB 118	
	62/931-7 1887964M91 54243590 TJB 103 12 cannettes / splines Longun/ Length :302 m			
	62/931-8 1052443M91 TJB 104 12 cannettes / 12 splines Longun/ Length :329 m			
M127	62/931-9 3477316M91 TJB 111, TJB 114 12 cannettes / 12 splines Longun/ Length :302 m	62/932-7 1897314M91 54268462 TEB 144	62/933-3 1810743M91 TAB 118	
	62/931-10 3473800M91 TJB 112 12 cannettes / 12 splines Longun/ Length :329 m			



Pièces de rechanges pour démarreurs "ISKRA" et "PARIS-RHONE" - Nous consulter
Spare parts for "ISKRA" & "PARIS-RHONE" starter motor- On request

Les références des pièces sont indicatives.
Nos pièces ne sont pas d'origine

Part numbers are quoted for reference purposes only.
Our parts and accessories are not original.



**PANNEAUX
PANELS**

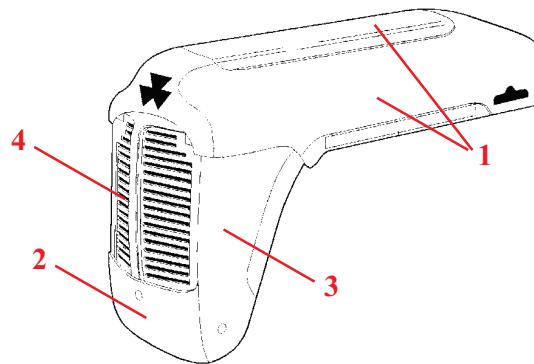

Fig.	1 + 2 + 3 + 4	1	2	3	4
Tracteurs Tractors	Jeu capot Bonnet kit	Panneau capot Hood side panel	Panneau inférieur Lower screen	Panneau latéral Side panel	Calandre Grill
35, 35X, 835	30/844-22K (828222M91 + 826817M92 + 1884060M91 + 826815M91 + 826816M91 + 826812M91)		30/843-1 (826817M92) 30/843-1H Avec trou pon amivé With handle hole	<i>Gauche / LH</i> 30/844-1 (826816M91) <i>Droit / RH</i> 30/844-2 (826815M91)	30/840-4 (826812M91)
133, 135, 140	30/844-23K (1884310M92 + 1882984M92 + 1886314M91 + 1882985M1 + 897822M1 + 897823M1)		30/843-5 (1882985M1)	<i>Gauche / LH</i> 30/844-26 (897822M1) <i>Droit / RH</i> 30/844-27 (897823M1)	30/841-1 (1886314M91) + 30/842-1 (1882984M92)
165, 165MKIII, 168, 175S, 178, 185, 188		<i>Gauche / LH</i> 30/839-5 (1883374M1) <i>Droit / RH</i> 30/839-6 (1883373M1)	30/838-4 (1886316M1)	<i>Gauche / LH</i> 30/844-28 (847844M91) <i>Droit / RH</i> 30/844-29 (847845M91)	30/841-3 (1860167M91, 898542M92) + 30/842-3 (897960M92, 847848M91)

Les références des pièces sont indicatives.
Nos pièces ne sont pas d'origine

Part numbers are quoted for reference purposes only.
Our parts and accessories are not original.



**GARDE-BOUES
FENDERS**

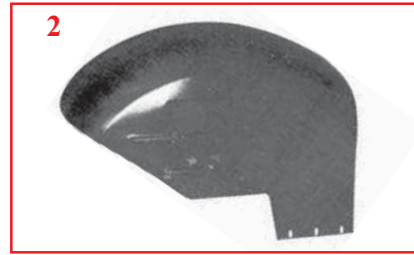
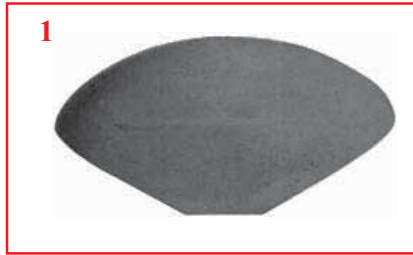

Tracteurs Tractors	Fig.	Réf. Ref.	OEM	Remarque Observation
TE20, 35, 35X	1	30/844-10	1883356M92	Gauche outroit avec araire LH or RH with bracket
		30/844-11		Gauche outroit sans araire LH or RH less bracket
35, 35X, 135	2	30/844-12	897751M91 1884286M97	Droit / RH
		30/844-13	897752M91 1884287M97	Gauche / LH
135	3	30/844-14	1885023M95	Droit avec coffre à outils RH with tool box
	4	30/844-15	1885024M95	Gauche avec coffre à outils LH with tool box
135, 230, 240	5	30/844-17	1679373M94	Droit sans coffre à outils, avec feu avant RH less tool box and with front side light
	6	30/844-16	1679374M94	Gauche sans coffre à outils, avec feu avant LH less tool box and with front side light

Les références des pièces sont indicatives.
Nos pièces ne sont pas d'origine

Part numbers are quoted for reference purposes only.
Our parts and accessories are not original.



**CALANDRES
FRONT GRILLE**



Tracteurs Tractors	Calandre Front grille				Porte de calandre Front grille door		Bas de calandre Lower panel	
35, FE35, 835	30/840-4 (826812M91)	1						
135 (⇒ 400000)	30/840-1 (1882982M92)	2	30/841-1 (1886314M91)	3	30/842-1 (1882984M92)	6	30/843-5 (1882985M1)	7
135 (400001 ⇒) 148	30/840-2 (1861365M91)		30/841-2 (1861364M91)		30/842-2 (1861374M91)			
165, 168, 175, 178, 185, 188	30/840-3 (1886315M91, 897949M92)		30/841-3 (1860167M91, 898542M92)		30/842-3 (897960M92, 847848M91)			
230, 240, 253, 263, 250, 254, 260, 264, 274, 284, 294			30/841-4 (1688814M92, 3701928M91, 1687819M91, 1682953M91)	4				
265, 275, 290, 298, 675, 690, 698, 699, 1004			30/841-5 (1687817M91)	5				

Les références des pièces sont indicatives.
Nos pièces ne sont pas d'origine

Part numbers are quoted for reference purposes only.
Our parts and accessories are not original.



**DECALCOMANIES
DECAL SETS**

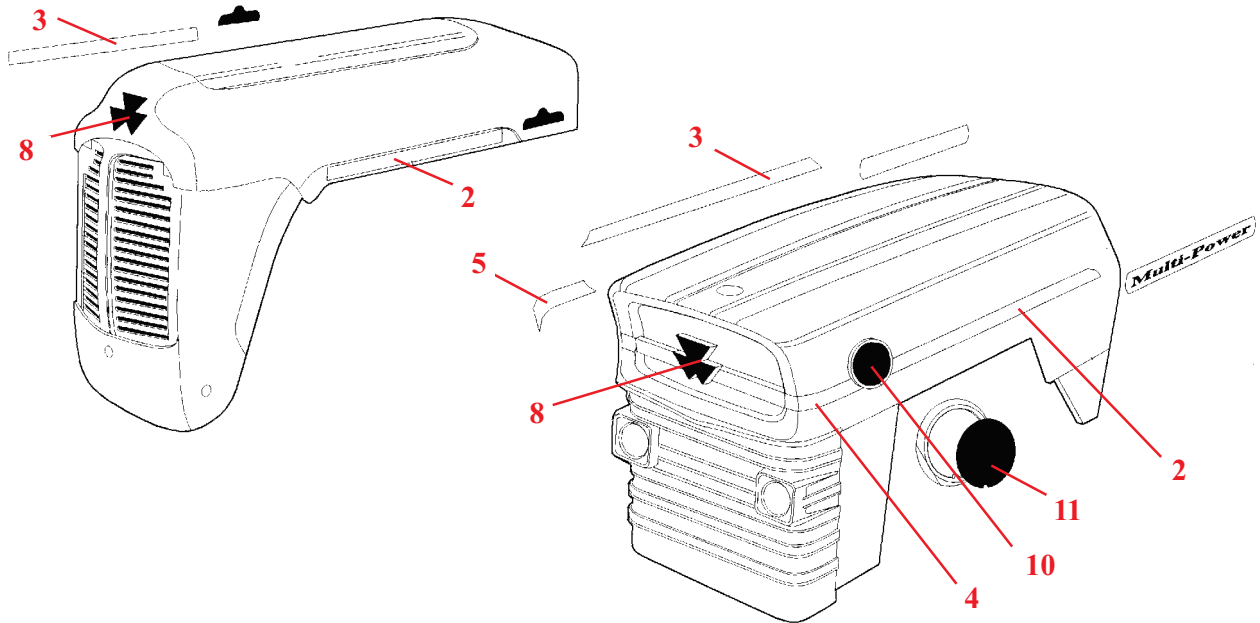

	1	2	3	4	5	8	10	11	
Tracteurs Tractors	Jeu Set	Gauche LH	Gauche LH	Droit RH	Droit RH	Emblème Emblem	Medallion	Décal. Stickers	
35	30/860-1 (3406970M91)								
35X	30/860-2 (3406971M91)					30/863-1 (888853M1)			
65	30/860-3 (3900333M91)								
135 (UK)	30/860-5 (B8605)	30/861-4 (1865030M1)		30/861-6 (1865029M1)				30/865-1 (1865460M1)	
148									
133, 135, 140 (France)									
165								30/863-2	30/867-3 (1866946M1)
168									30/867-4 (1866948M1)
175				30/861-9 (899879M1)	30/861-10 (1862805M1)	30/861-11 (899878M1)			30/867-6 (1866951M1)
178									30/867-7 (1866947M1)
185									30/867-8 (1866949M1)
188									

Emblème / *Emblem*

30/868-1

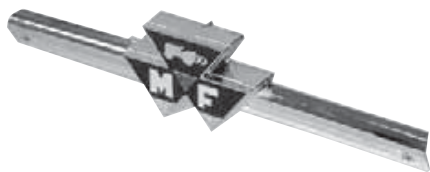

Les références des pièces sont indicatives.
Nos pièces ne sont pas d'origine

Part numbers are quoted for reference purposes only.
Our parts and accessories are not original.



**DECALCOMANIES
DECAL SETS**

	1	8
Tracteurs Tractors	Jeu Set	Emblème Emblem
230	30/860-6 (3900614M91)	30/863-13 (1682944M91)
240	30/860-7 (3406978M92)	
250	30/860-8 (3406979M91)	
265	30/860-9 (3406981M91)	
275	30/860-10 (3406983M92)	
290	30/860-12 (3406895M92)	
340	30/860-106 (3900562M91)	
350	30/860-108 (3900316M91)	
355	30/860-109 (3900317M91)	
360	30/860-107 (3900318M91)	
365	30/860-125 (3900320M92)	
375	30/860-111 (3900321M92)	
390, 390T (⇒ B18008)	30/860-112 (3900322M92)	
390 (B18009 ⇒)	30/860-113 (3901083M91)	
390T (B18009 ⇒)	30/860-126 (3901084M91)	
398	30/860-127 (3900323M92)	
399	30/860-114 (3900324M92)	
590	30/860-17 (3900328M91)	
595	30/860-18 (3900329M91)	
675	30/860-19 (3900330M91)	30/863-13 (1682944M91)
690	30/860-20 (3900331M91)	
698 (2WD)	30/860-21	
698 (4WD)	30/860-22	
699	30/860-24 (3900332M1)	

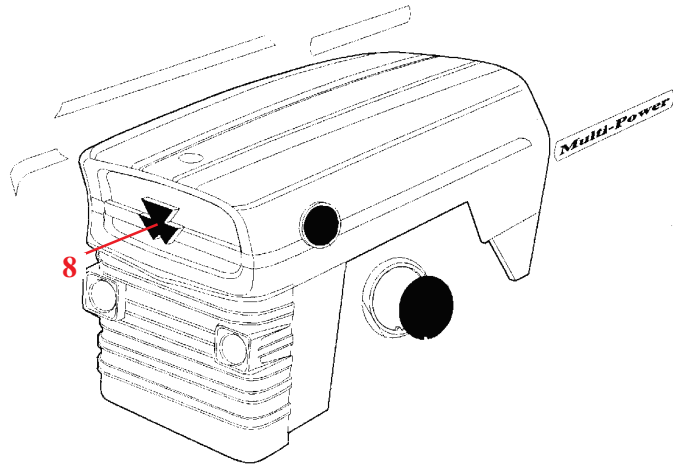

	1	8
Tracteurs Tractors	Jeu Set	Emblème Emblem
3060	30/860-115 (3902040M91)	
3065	30/860-116 (3902048M91)	
3070	30/860-117 (3900345M92)	
3075	30/860-118 (3902049M91)	
3080	30/860-119 (3900346M91)	
3085	30/860-120 (3902043M91)	
3090	30/860-121 (3900347M91)	
3095	30/860-122 (3902042M91)	
3120	30/860-123 (3902044M91)	
3125	30/860-124 (3902038M91)	

Les références des pièces sont indicatives.
Nos pièces ne sont pas d'origine

Part numbers are quoted for reference purposes only.
Our parts and accessories are not original.



**SIEGES
SEATS**

61/830-980 : Velours bleu

Blue velvet

61/830-981 : Tissu noir /

Black cover

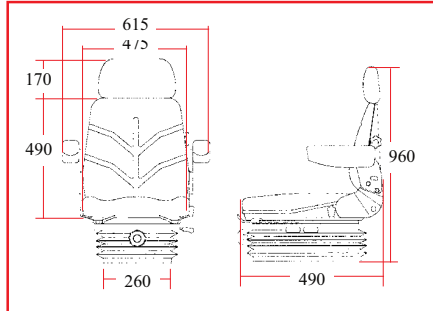

Régage bhre
Adjustable lumbar support

Accodoirs réglabs

Adjustable arm rest

Inclinaison dudossier

Reclining back rest

Base pivotante

Turntable

Inclinaison de l'assise

Base tilting

Inclinaison d'nez

Nose tilting

Régage suivant le poids du conducteur

Adjustment for driver weight

Régage longitudinal

Longitudinal adjustment

35, 65, 135, 148, 165, 168, 175, 178, 185, 188, 230, 235, 240, 245, 265, 275, 290



61/830-611
(181313M91)

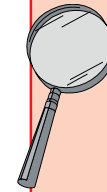

**Pour les sièges
voir aussi
notre catalogue
au fascicule 1**

**For seats
see also
our catalogue
part 1**

HOUSSES / SEAT COVERS

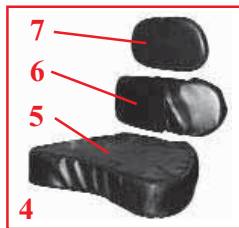
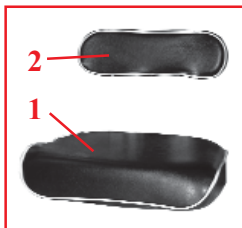

Tracteurs Tractors	Réf. Ref.	Fig.	Description
25, 35, 65, 122, 130, 133, 135, 140, 165, 168, 175, 178, 185, 230, 235, 240, 245, 265, 275, 290, 765, 825, 835, 865	61/831-1 (965447M91, 1884576M91)	1	Assise / Seat
	61/832-1 (1883238M91, 1638480M91)	2	Dossier / Back rest
Série 200 series	61/831-29	3	Housse / Cover
	61/831-30	4	Ensemble / Set
	61/831-31	5	Assise / Seat
	61/832-5	6	Dossier inférieur / Lower back rest
	61/832-6	7	Dossier supérieur / Upper back rest
Siège Sab seat	61/831-32	8	Coussin pour vigneron / Cover for vineyard
	61/831-33	9	Housse 1 pièce / Cover 1 part

Les références des pièces sont indicatives.
Nos pièces ne sont pas d'origine

Part numbers are quoted for reference purposes only.
Our parts and accessories are not original.



"THE RELIABLE SERVICE"



**VERINS A GAZ
GAS STRUTS**



Tracteurs Tractors	Pare-Brise Windscreen	Porte Door	Toit Roof	Vitre arrière Rear window
154, 174, 184, 194		30/872-51 (3103957M1)		
154, 254, 274, 1114, 1134			30/871-26 (1427157M91)	30/870-64 (1427130M92)
Série 200 series Cabne SankyLPQ Cab			30/871-3 (1897726M91)	30/870-3 (1897990M91, 3476187M1)
342, 350, 352, 355, 360, 362, 365, 372N, 375, 382N, 390, 396, 398, 399		30/872-2 (3478319M2, 3476027M1)	30/871-3 (1897726M91)	
233, 253, 263, 273, 283, 293, 333, 353, 363, 373, 383, 393	30/870-74 (3103958M1)	30/872-51 (3103957M1)		30/870-74 (3103958M1)
354, 364, 374, 384, 394				30/872-51 (3103957M1) L:317m 30/870-74 (3103958M1) L:361m
Série 500 series Moiss-Bat / Combines 530, 535, 560, 565, 660, 665, 800, 805, 810, 815, 820, 825, 830, 835, 840, 845 Ind 20E, 30D				30/870-1 (1873903M91)
Série 600 series 274 SK, 284S, 294S, 377, 387, 397, 397T, 1004, 1004T, 1007, 1014, 1024				30/870-2 (3301920M92)
Séries 2600, 2700 series		30/872-1 (3380149M2)		30/870-1 (3384671M1, 1873903M91)
Série 3000 series	30/870-74 (3103958M1)	30/872-3 (3385316M91)	30/871-1 (3303021M91, 3301617M91)	30/870-74 (3103958M1) L:361m 30/870-4 (3389556M2) L:786m
Séries 3100, 3600 series				30/870-4 (3389556M2)
Séries 4200, 4300 series	30/870-53 (3805354M1, 3804759M1, 3806767M1)	30/870-53 (3805354M1, 3804759M1)	30/871-39 (3901826M91)	30/870-53 (3805354M1, 3804759M1)
Séries 6100, 6200, 8100, 8200 series		30/872-43 (3902121M3)	30/871-1 (3303021M91)	30/870-63 (3902140M1)

Les références des pièces sont indicatives.
Nos pièces ne sont pas d'origine

Part numbers are quoted for reference purposes only.
Our parts and accessories are not original.

MF-430



"THE RELIABLE SERVICE"



Ed.1 (07/04)

**PEINTURE
PAINT**

LAQUE AMERICAINE

**LA MEILLEURE PEINTURE
DU MARCHE**

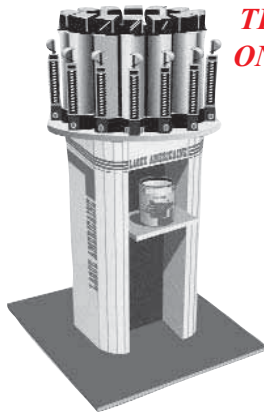

**THE BEST PAINT
ON THE MARKET**



**Plus de 2000 nuances possibles
Possibilité de créer une couleur
suivant échantillon**

**More than 2000 colors available
Possibility to create a color
from a sample**

Couleur Colour	1 L	5 L	Spray
Super rouge Super red	30/3102-236 (3620501M5)	30/3102-237 (3620502M6)	30/3102-238 (3405500M7)
Nouveau gris argent New silver mist	30/3102-230 (3620504M5)		30/3102-232 (3405503M7)
Gris argent non métallisé Smoke grey	30/3102-203 (3930935M5)	30/3102-204 (3930936M6)	30/3102-205 (3930937M7)
Gris clair Light grey	30/3102-227 (3620512M5)	30/3102-228	30/3102-229 (3405544M7)
Gris silex Flint grey	30/3102-242 (3405511M5)	30/3102-243	30/3102-244 (3405545M7)
Gris Grey	30/3102-212 (3620506M5)	30/3102-213	30/3102-214 (3405505M7)
Gris stoneleigh Stoneleigh grey	30/3102-239 (3620507M5, 3405507M3)	30/3102-240 (3405631M3)	30/3102-241 (3405543M7)
Gris ardoise Slate grey	30/3102-224 (3930938M5)	30/3102-225 (3930939M6)	30/3102-226 (3930940M7)
Gris foncé Charcoal grey	30/3102-200 (3620514M5, 3405574M2)	30/3102-201 (3620516M6)	30/3102-202 (3405615M7)
Gris argent Silvermist	30/3102-209 (3405633M5)	30/3102-210 (3405635M6)	30/3102-211 (3405634M7)
Gris métallisé Flint grey metallic	30/3102-233 (3620509M5)	30/3102-234 (3405510M3)	30/3102-235 (3405508M7)
Aluminium Aluminium	30/3102-215 (3620520M5)	30/3102-216	30/3102-217
Noir mat Dull black	30/3102-206 (3620518M5)	30/3102-207	30/3102-208 (3405517M7)
Noir brillant Black gloss	30/3102-218 (3620513M5, 3405513M3)	30/3102-219	30/3102-220
Jane industriel Industrial yellow	30/3102-221 (3405636M5, 3405515M2)	30/3102-222 (3405516M6)	30/3102-223 (3405514M7)
Jane construction Construction yellow	30/3102-245 (3405614M5)	30/3102-246 (3405549M6)	30/3102-247 (3405617M7)

Marché anglais seulement / UK market only

Colour	1 L	5 L	Spray	Colour	1 L	5 L	Spray
Super red	3102-050	3108-050	3109-050	Mat black	3102-085		3109-085
New silver mist	3102-102			Black gloss	3102-008	3108-008	3109-008
Flint grey metallic	3102-083			Buff undercoat	3102-061		3109-061
Ferguson grey	3102-009	3108-009		Dark grey undercoat	3102-135		
Stoneleigh grey	3102-025		3109-025	Grey undercoat	3102-020	3108-020	
Grey	3102-140			Red oxide	3102-021		3109-021
Charcoal grey	3102-046			Red primer	3102-065		
Silvermist	3102-019			Red primer gloss	3102-087		
Dark stoneleigh grey	3102-148			Black primer	3102-067		
Industrial yellow	3102-028	3108-028		Mat black Primer	3102-158		
Construction yellow	3102-031			White primer	3102-066		
Brown	3102-099						

Les références des pièces sont indicatives.
Nos pièces ne sont pas d'origine

Part numbers are quoted for reference purposes only.
Our parts and accessories are not original.



"THE RELIABLE SERVICE"



**PEINTURE
PAINT**

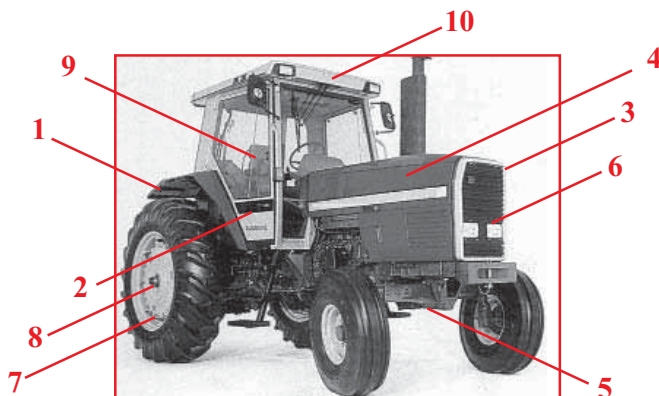

	1	2	3	4	5	6	7	8	9	10			
Tracteurs Tractors	Garde-boue Fender	Cabine Cab	Calandre Grill	Capot Bonnet	Chassis Chassis	Grille Grill	Jante Rim	Moyeu Hub	Siège Seat	Toit Roof			
TE20	Gris clair Light grey		Gris clair Light grey	Gris clair Light grey	Gris clair Light grey				Gris clair Light grey				
FE35 35													
65	Sper rouge Super red			Sper rouge Super red	Gris stoneleigh Stoneleigh grey				Sper rouge Super red				
Séries 100, 200, 300, 1000 (Ita) Series		Gris argent Silvermist	Gris argent Silvermist		Gris foncé Charcoal grey	Noir mat Dull black	Alu Aluminium	Gris foncé Charcoal grey					
Série 100 (UK) Series					Gris stoneleigh Stoneleigh grey			Gris argent Silvermist					
Série 100 (France) Series					Gris étalé Flint grey metallic								
Série 200 (UK, France) ⇒ 1979 Series													
Série 200 (UK, France) 1979⇒1980 Series											Sper rouge Super red		
Série 200 (UK, France) 1980⇒1981 Series							Gris Grey						
Série 200 (UK, France) 1982 ⇒ Series									Gris argent Silvermist				
Série 300 (UK) Series			Noir mat Dull black		Gris argent Silvermist		Gris foncé Charcoal grey			Gris foncé Charcoal grey		Sper rouge Super red	

Les références des pièces sont indicatives.
Nos pièces ne sont pas d'origine

Part numbers are quoted for reference purposes only.
Our parts and accessories are not original.



**PEINTURE
PAINT**

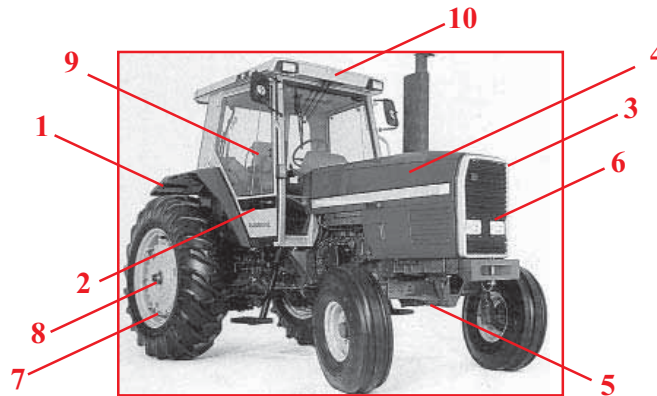

	1	2	3	4	5	6	7	8	9	10	
Tracteurs Tractors	Garde-boue Fender	Cabine Cab	Calandre Grill	Capot Bonnet	Chassis Chassis	Grille Grill	Jante Rim	Moyeu Hub	Siège Seat	Toit Roof	
Série 500 (UK) ⇒ 1979 Series	Sper roge Super red	Sper roge Super red	Alum Aluminium	Sper roge Super red	Gris stonehigh Stoneleigh grey	Noir at Dull black		Alum Aluminium		Alum Aluminium	
Série 500 (UK) 1979⇒1980 Series			Gris Grey		Sper roge Super red						
Série 500 (UK) 1980⇒1981 Series			Gris argent Silvermist					Sper roge Super red			
Série 500 (UK) 1982 ⇒ Series			Gris foncé Charcoal grey								
Série 500 (France) 1981 ⇒ Series		Gris étalésé Flint grey metallic	Alum Aluminium		Gris foncé Charcoal grey			Gris argent Silvermist		Gris argent Silvermist	Gris argent Silvermist
Série 500 (France) 1982 ⇒ Series		Gris foncé Charcoal grey			Sper roge Super red			Gris argent Silvermist			
595 (France) ⇒ 1979		Gris étalésé Flint grey metallic	Sper roge Super red							Gris argent Silvermist	
595 (France) 1979 ⇒1980		Gris Grey			Sper roge Super red			Gris argent Silvermist			
595 (France) 1981 ⇒		Gris foncé Charcoal grey	Sper roge Super red							Gris argent Silvermist	
Série 600 (UK, France) Series		Gris Grey			Sper roge Super red			Gris argent Silvermist			
Série 2200, 2600, 2700 (France) 1981 ⇒ Series		Gris foncé Charcoal grey	Sper roge Super red							Gris argent Silvermist	
Série 2200, 2600, 2700 (France) ⇒ 1982 Series		Gris argent Silvermist			Sper roge Super red			Gris argent Silvermist			
Série 3000, 3100, 3600 (France)	Gris foncé Charcoal grey	Sper roge Super red	Gris argent Silvermist								
	Nouveau gris argent New silver mist			Sper roge Super red	Gris argent Silvermist						
	Gris foncé Charcoal grey	Sper roge Super red	Gris argent Silvermist								

Les références des pièces sont indicatives.
Nos pièces ne sont pas d'origine

Part numbers are quoted for reference purposes only.
Our parts and accessories are not original.



"THE RELIABLE SERVICE"



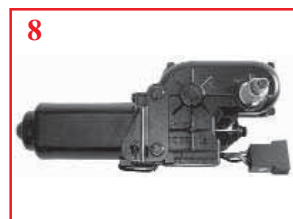
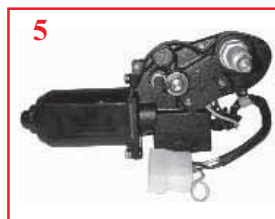
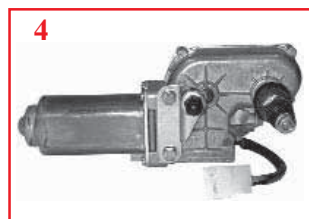
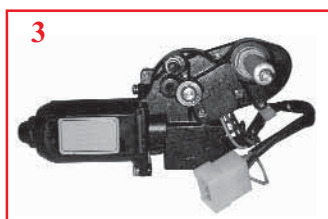
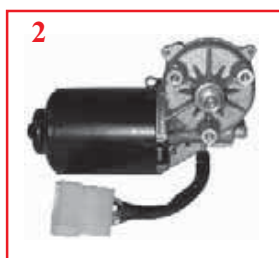

MOTEURS D'ESSUIE-GLACE
WIPER MOTORS



Tracteurs Tractors	Avant / Front			Arrière / Rear		
	Réf Ref	Fig.	OEM	Réf Ref	Fig.	OEM
154, 254, 274, 1114, 1134	63/1980-17	1	1427013M92			
284S, 294S, 1014	63/1980-18	2	3301889M91			
342, 352, 362N, 372N, 382N, 396, 399 365, 375, 390, 390T, 398 (⇒ B18009)	63/1980-23	3	3900628M2	63/1980-7	4	3597357M92
Cabines Lowprofil & Hilne cabs	63/1980-22 (A)	5	3901103M2			
Série 3000, 3100, 3600 series	63/1980-19	6	3385255M93			
Séries 6100, 6200, 8100, 8200 series	63/1980-6	7	3777698M92 3902337M2	63/1980-43 Arrêt droite / RH stop	8	3713194M1
				63/1980-44 Arrêt gauche / LH stop		3715610M1

(A) :Pare-brise ouvrant / Openable windscreen

CHAUFFAGE DE CABINE
CAB HEATING

Tracteurs Tractors	Réf Ref	OEM	Fig.
Séries 500, 2600, 2700 series	30/1988-2	1610023M94	
Séries 3000, 6000, 8000 series	30/1988-3	3310831M91 3902321M91	

Les références des pièces sont indicatives.
Nos pièces ne sont pas d'origine

Part numbers are quoted for reference purposes only.
Our parts and accessories are not original.



BALAIS D'ESSUIE-GLACE WIPER BLADES











Tracteurs Tractors	Avant / Front			Arrière / Rear		
	Réf Ref	OEM	Longueur Length	Réf Ref	OEM	Longueur Length
135, 148, 165, 168, 175, 178, 185, 188	70/1987-9		400-410m 16'			
Série 200 Series Ind. 50, 24	70/1987-9 (⇒ 1220)	1897910M1 3620123M91	400-410m 16'			
	70/1987-18 (1220 ⇒)	3473013M1 3620125M91	450-460m 18'			
284S, 294S, 1014	70/1987-31	3301898M91	500-510m 20'			
Série 300 Series Ind. 40E, 20F, 50E, 50EX,	70/1987-20	3476043M1 3620127M91	500-510m 20'	70/1987-9	3597359M91 3406992M91 3620123M91	400-410m 16'
Série 500 Series Ind. 20B, 20D, 20E	70/1987-9 Type SEV- Marchl typ	1671631M1 3620123M91	400-410m 16'			
	70/1987-16 Type Luas typ	1610025M91 1897375M91 3620124M91	400-410m 16'			
Série 600 Series 274SK, 294S, 377, 387, 397, 397T, 1004, 1004T, 1007, 1014, 1024	70/1987-12	3302795M91 3620129M91	600-610m 24'	70/1987-9	3620123M91	400-410m 16'
Série 2000 Series Ind. 30D, 30H, 50H, 50HX, 60H	70/1987-22	3385801M1 3620128M91	550-560m 22'	70/1987-11	3620121M91 3052261M1	300-310m 12'
	70/1987-20	3381565M1 3620127M91	500-510m 20'			
Séries 3000, 3100, 3600 Series	70/1987-12	3385254M91 3620129M91	600-610m 24'	70/1987-9	3620123M91	400-410m 16'
Séries 4200, 4300 Series Cabne std / Std cab	70/1987-41	3808788M91	600-610m 24'	70/1987-44	3808790M91	550-560m 22'
	70/1987-42 Pare-brise ouvrant Openable windscreen	3812439M91	450-460m 18'			
Séries 4200, 4300 Series Cabne hte visibilité High visibility cab	70/1987-42	3812439M91	450-460m 18'	70/1987-42	3812439M91	450-460m 18'
	70/1987-43	3777648M91	500-510m 20'			
Séries 6100, 6200, 8100, 8200 Series Cabne hte visibilité High visibility cab	70/1987-43	3777648M91	500-510m 20'	70/1987-45	3713195M1	450-460m 18'
650, 660, 680 Séries 6100, 6200, 8100, 8200 Series Cabne std / Std cab	70/1987-38	3714194M91	600-610m 24'			

Les références des pièces sont indicatives.
Nos pièces ne sont pas d'origine

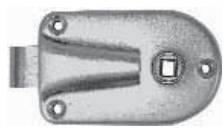
Part numbers are quoted for reference purposes only.
Our parts and accessories are not original.



POIGNEES ET SERRURES
LOCKS & HANDLES

Réf. Ref.	OEM	Description	Fig.	Tracteurs Tractors
70/847-1	897788M91 962148M91	Poignée de bq̄t de capot arrière <i>Rear bonnet latch handle</i>		133, 135, 140, 145, 148, 152, 155, 158, 165, 168
70/847-3	885365M91 962139M91 1888296M91	Poignée de bq̄t de capot avant <i>Front bonnet latch handle</i>		
70/4170-31	1884003M91	Poignée <i>Handle</i>		135, 165, 175, 178
70/4170-56	1884002M91	Serr̄ne <i>Lock</i>		
70/4170-89	1427093M91	Serr̄ne droite <i>Lock (RH)</i>		154, 254, 274, 1114, 1134
70/4170-90	1427094M91	Serr̄ne gauch̄ <i>Lock (LH)</i>		
70/4170-55	1897727M91 3473512M91	Poignée <i>Handle</i>		Série 200 series Calme SankyLPQ <i>cab</i> Ind. 20E, 30D
70/4170-15	3473298M91	Serr̄ne droite <i>Lock (RH)</i>		
70/4170-14	3473297M91	Serr̄ne gauch̄ <i>Lock (LH)</i>		
70/4170-104	3473427M1	Poignée <i>Handle</i>		Série 200 series Calme SankyGKN 01739 ⇔
70/4170-18	1877159M92 1667203M92	Poignée ext̄rieure <i>Outer handle</i>		Série 200 Calme XLC <i>cab</i>
70/4170-57	1670819M92 1877857M96	Poignée int̄rieure droite <i>Inner handle (RH)</i>		
70/4170-58	1670820M92	Poignée int̄rieure gauch̄ <i>Inner handle (LH)</i>		
70/4170-30	3476151M1	Poignée ext̄rieure <i>Outer handle</i>		Série 300 series
70/4170-88	3476157M1	Poignée int̄rieure droite <i>Inner handle (RH)</i>		
70/4170-87	3476171M1	Poignée int̄rieure gauch̄ <i>Inner handle (LH)</i>		
70/4170-18	1877159M92 1667203M92	Poignée ext̄rieure <i>Outer handle</i>		Série 500 series Ind. 20D
70/4170-58	1670820M92	Poignée int̄rieure droite <i>Inner handle (RH)</i>		
70/4170-57	1670819M92 1877857M96	Poignée int̄rieure gauch̄ <i>Inner handle (LH)</i>		

Les références des pièces sont indicatives.
Nos pièces ne sont pas d'origine

Part numbers are quoted for reference purposes only.
Our parts and accessories are not original.



**POIGNEES ET SERRURES
LOCKS & HANDLES**

Réf. Ref.	OEM	Description	Fig.	Tracteurs Tractors
70/4170-60	3301854M91	Serrure gauche Lock (LH)		Série 600 series 274SK, 284S, 294S, 377, 387, 397, 397T, 1004, 1004T, 1007, 1014, 1024
70/4170-61	3301855M91	Serrure droite Lock (RH)		
70/4170-59	3301853M92	Poignée extérieure Outer handle		
70/4170-62	3301856M2	Poignée intérieure Inner handle		
70/4090-1	3301221M2	Charnière vitre arr. et latéral 2 trous Rear and side window hinge (2 holes)		
70/4090-2	3301222M1	Charnière vitre arr. et latéral 1 trou Rear and side window hinge (1 hole)		
70/4090-5	3385322M1	Axe de charnière Hinge pin		
70/4170-18	1865985M91 1884693M91 3040378M1 3323536M91 3904169M1 530316M1	Poignée extérieure Outer handle		Séries 1000, 2600, 2700 series Ind. 20D, 50, 50B
70/4170-51	3385310M91	Serrure droite Lock (RH)		Séries 3000, 3100, 3600 series
70/4170-52	3385311M91	Serrure gauche Lock (LH)		
70/4170-53	3385314M91	Poignée Handle		
70/4177-1	3385371M1	Ressort Spring		
70/4090-1	3301221M2	Charnière vitre arr. et latéral 2 trous Rear and side window hinge (2 holes)		
70/4090-2	3301222M1	Charnière vitre arr. et latéral 1 trou Rear and side window hinge (1 hole)		
70/4090-5	3385322M1	Axe de charnière Hinge pin		

**BOITES À OUTILS
TOOL BOXES**

70/1563-1
(825633M91)
280x100x100m

TE20, 25, 35, 35X, 65,
122, 130, 133, 135, 140,
145, 148, 152, 155, 158,
168, 765, 825, 835, 865

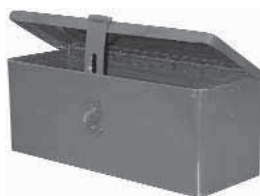

70/1563-2
420x115x112m



70/1563-3
420x160x160m

Les références des pièces sont indicatives.
Nos pièces ne sont pas d'origine

Part numbers are quoted for reference purposes only.
Our parts and accessories are not original.



**RETROVISEURS
MIRRORS**

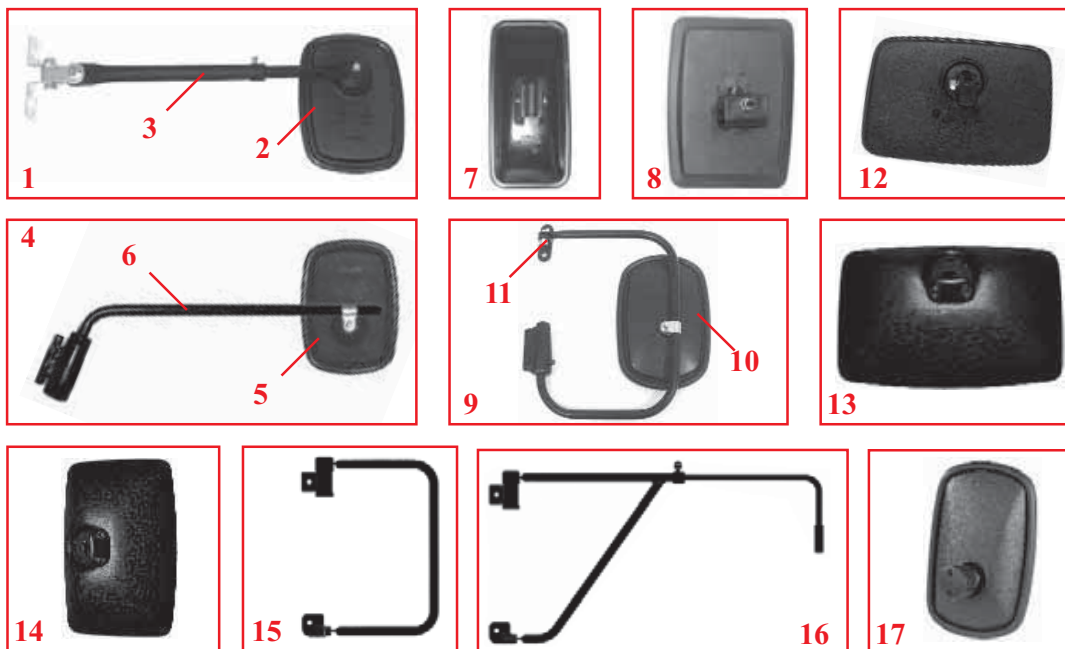











Tracteurs Tractors	Fig.	Réf. Ref.	OEM	Description	Remarque Observation
Ancienne gam Old range	1	30/850-4		Copët / Complete	117x125m Bras extensib Extensible arm
	2	30/851-4		Rétrovisen/ Mirror	
	3	30/853-2		Bras / Arm	
135, 168, 175, 178, 185, 188, 230, 240, 265, 275, 290, 298	4	30/850-3		Copët / Complete	177x125m
	5	30/851-4		Rétrovisen/ Mirror	
154, 254, 274, 1114, 1134	7	30/851-2	1427251M91	Rétrovisen/ Mirror	354x169m Øm
				8	
550, 565, 575, 590, 595, 1200, 1250	9	30/850-1	1871948M93	Copët / Complete	242x163m Ø6/17m
	10	30/851-1	1891218M91	Rétrovisen/ Mirror	
	11	30/853-1	1891226M91	Bras / Arm	
560, 575, 590, 592, 595, 595MKII, 2620, 2640, 2645, 2680, 2685, 2720, 2725	12	30/851-7	1635999M91	Rétrovisen/ Mirror	
230, 342, 352, 362, 362N, , 365, 372N, 375, 382N, 390T, 396, 398, 399, 2685, 2725, 3120, 3125, Série 3000, 3600, 4200, 4300, 6100, 6200, 8100, 8200 series	13	30/851-8	3806618M91	Rétrovisen intérien Interior mirror	247x157m Ø4/20m
				30/851-5	
Série 3100, 3600, 6100, 8100 series	14	30/851-6	3104955M1	Rétrovisen/ Mirror	310x220m Ø6/18m
	16	30/853-8	3104953M2	Bras droit / RH arm	
		30/853-9	3712206M1	Bras gauh / LH arm	
Série 4200, 4300, 6100, 6200, 8100, 8200 series	15	30/853-4	3806611M92	Bras droit / RH arm	
		30/853-5	3806610M92	Bras gauh / LH arm	
	16	30/853-6	3806613M93	Bras droit / RH arm	
		30/853-7	3806612M93	Bras gauh / LH arm	
	17	30/851-9	3806614M91	Rétrovisen/ Mirror	

Les références des pièces sont indicatives.
Nos pièces ne sont pas d'origine



Part numbers are quoted for reference purposes only.
Our parts and accessories are not original.



PROFILES D'ETANCHEITE POUR GLACES DE CABINE
GLAZING RUBBER AND DRAFT EXCLUDERS

	Profils (Caoutchouc noir) Sections (Black rubber)						Profils d'étanchéité (Noir) Sections (Black)			
Réf. Ref.										
	70/4110-9 (A)	70/4110-10 (B)	70/4110-11 (C)	70/4111-4	70/4110-12	70/4110-13	70/4112-2	70/4112-3	70/4112-4	70/4112-5
Dingée Glass size	6,0m 4,7m 4,7m			5,0m 4,0m 6,0m	2,0-5,0m	5,0m 5,5m				
Paroi Panel	1,2-1,6m	1,2-1,6m	2,6-3,2m	Lacet pon Filler strip for A, B, C	2,0m 2,0m					

AMORTISSEURS DE CABINE
CAB DAMPERS

Tracteurs Tractors	Fig.	Réf. Ref.	OEM
154, 254, 274, 284S, 294S, 1014, 1024, 1114, 1124		30/4114-14	1425984M91
353, 363, 377, 383, 387, 393, 397, 1007		30/4114-15	3533074M1

HABILLAGES INTÉRIEURS
INTERIOR TRIMS



**Nous pouvons fournir sur commande
des habillages de cabine.
Consultez-nous !**

**We could supply interior trims.
Please contact us !**



FILTRES DE CABINE
CAB FILTERS



Consultez la section filtration ! / Please see filters section !



Les références des pièces sont indicatives.
Nos pièces ne sont pas d'origine

Part numbers are quoted for reference purposes only.
Our parts and accessories are not original.



**VITRERIE DE CABINE
CAB GLASS**

Séries 200 series
Cabine XLC cab
260, 265, 275, 285, 290

Vitres claires
Plain glass

Pare-brise / Windscreen

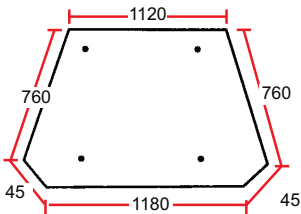

30/4000-78
(1673335M1)

Arrière supérieure / Upper rear

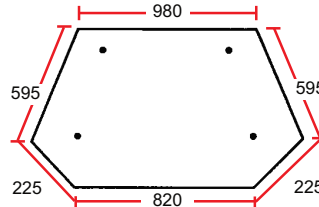

30/4072-81
(1673443M1)

Arrière inférieure / Lower rear

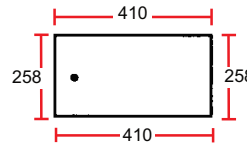

30/4074-9
(1673454M1)

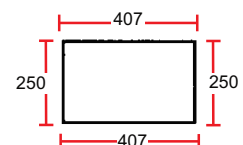

30/4075-9
(1673161M1)

Latérale / Side

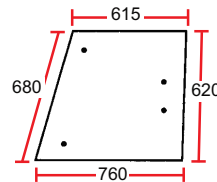

30/4047-58
(1673204M1)



Avant / Front

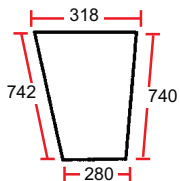

30/4012-53
(1673327M1)

Porte supérieure / Upper door

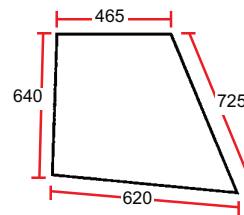

30/4022-40
(1673200M1)

Porte inférieure / Lower door

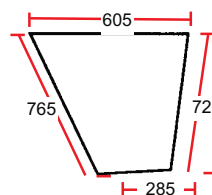

30/4021-40
(1673201M1)

Les références des pièces sont indicatives.
Nos pièces ne sont pas d'origine

Part numbers are quoted for reference purposes only.
Our parts and accessories are not original.



**VITRERIE DE CABINE
CAB GLASS**

Séries 200 series
Cabine XLB cab
265, 275, 290

Vitres chères safi (*)
Plain glass except (*)

Pare-brise / Windscreen

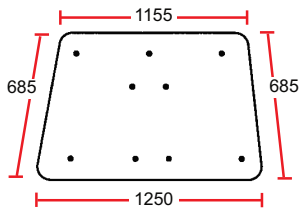

30/4001-9 (*)
(M512136)

Arrière / Rear

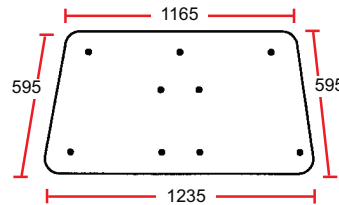

30/4071-29
(M555041)

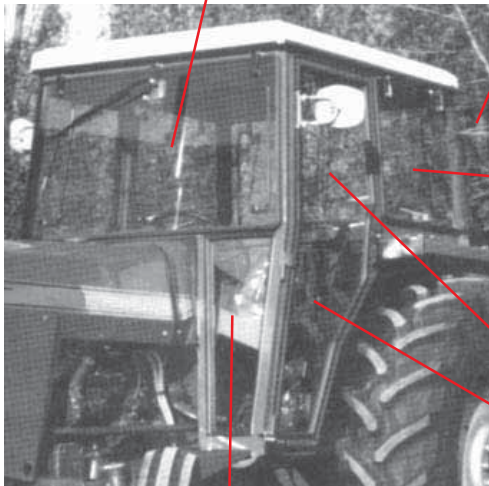

Latéral / Side

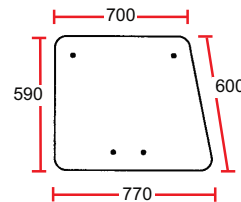

30/4047-57
(M544516)

Avant / Front

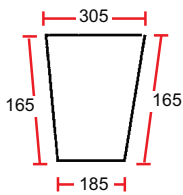

30/4012-52
(M544162)

Porte supérieure / Upper door

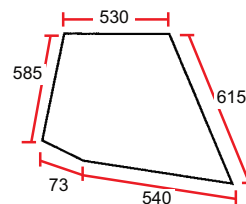

30/4022-39
(M524043)

Porte inférieure / Lower door

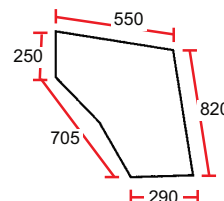

30/4021-39
(M534199)

Les références des pièces sont indicatives.
Nos pièces ne sont pas d'origine

Part numbers are quoted for reference purposes only.
Our parts and accessories are not original.



**VITRERIE DE CABINE
CAB GLASS**

Séries 200 series
Cabine SankeyGKN cab
265, 275, 290

Vitres claires / Plain glass

Toutes les vitres existent aussi en version teintée, ajouter le suffixe T
All glass can be supplied tinted, please add suffix T

Utilisez les profilés / Use the rubber
70/4112-4 & 70/4110-12

Pare-brise / Windscreen

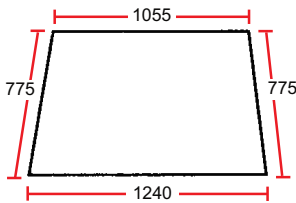

30/4000-16
(1897855M1)

Arrière supérieure / Upper rear

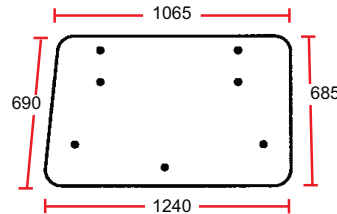

30/4072-3
(1897724M1)

Arrière inférieure / Lower rear

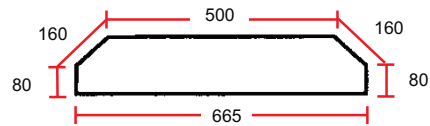

30/4073-172
(1897859M1)

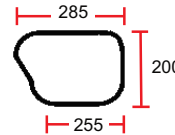

30/4080-3
(1897854M1)



Avant / Front

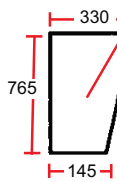

30/4012-12
(1897856M1)

Latéral / Side

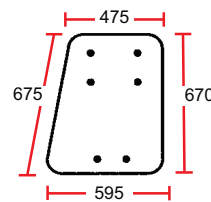

30/4047-5
(1897852M1)

2 trous pour poignée
2 holes for handle

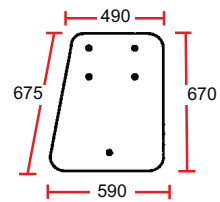

30/4047-4
(3473415M1)

1 trou pour poignée
1 hole for handle

Porte inférieure / Lower door

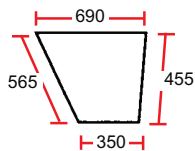

30/4021-10
(1897858M1)

⇒ 02326

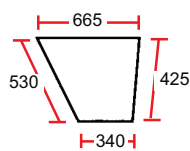

30/4021-11
(3473435M1)

02326 ⇒

Porte supérieure / Upper door

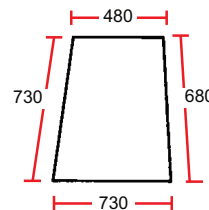

30/4022-9
(1897857M1)

Les références des pièces sont indicatives.
Nos pièces ne sont pas d'origine

Part numbers are quoted for reference purposes only.
Our parts and accessories are not original.



**VITRERIE DE CABINE
CAB GLASS**

Séries 200 series
Cabine SankeyGKN cab
240, 250

Vitres claires / Plain glass

Toutes les vitres existent aussi en version teintée, ajouter le suffixe T
All glass can be supplied tinted, please add suffix T

Utilisez les profils / Use the rubber
70/4112-4 & 70/4110-12

Pare-brise / Windscreen

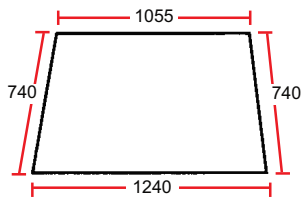

30/4000-15
(1897898M1)

Arrière supérieure / Upper rear

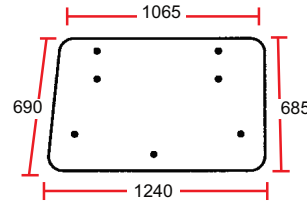

30/4072-3
(1897724M1)

Arrière inférieure / Lower rear

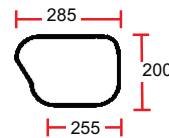

30/4080-3
(1897854M1)

Latéral / Side

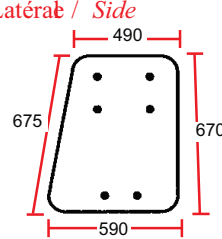

30/4047-5
(1897852M1)

2 trous pour poignée
2 holes for handle

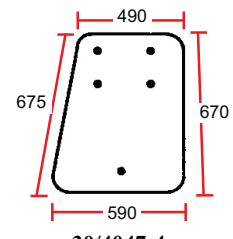

30/4047-4
(3473415M1)

1 trou pour poignée
1 hole for handle



Porte inférieure / Lower door

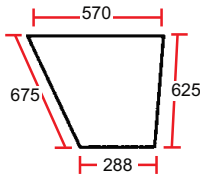

30/4021-8
(1897861M1)

⇒ 01427 & ⇒ 01517

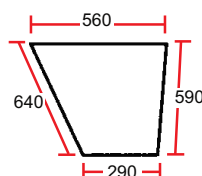

30/4021-9
(3473434M1)

01427 ⇒ 01517 ⇒

Porte supérieure / Upper door

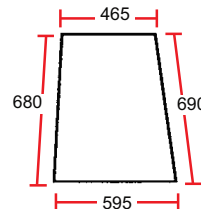

30/4022-8
(1897860M1)

Avant / Front

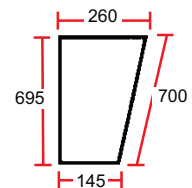

30/4012-11
(1897853M1)

Les références des pièces sont indicatives.
Nos pièces ne sont pas d'origine

Part numbers are quoted for reference purposes only.
Our parts and accessories are not original.



VITRERIE DE CABINE
CAB GLASS

Séries 300 series

Cabne grise
Grey cab

Vitres claires / Plain glass

Pare-brise / Windscreen

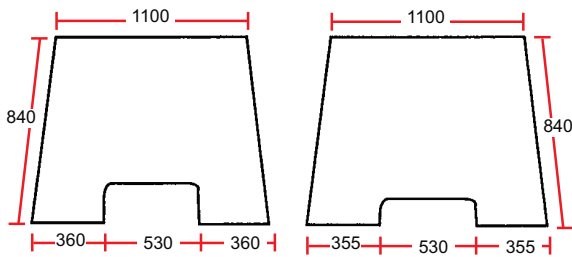

30/4000-17
(3475991M1)
⇒ N11005

30/4000-41
(3478320M1)
N11006 ⇒

Utilisez profilés / Use the rubber
70/4112-4 & 70/4110-12

Arrière supérieure / Upper rear

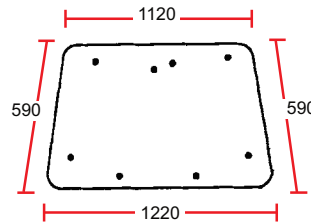

30/4072-5
(3477716M1)

Arrière inférieure / Lower rear

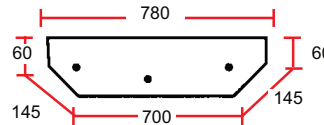

30/4073-3
(3476137M1)

Latérale / Side

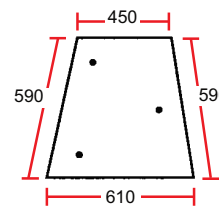

30/4047-6
(3476127M1)
⇒ B18008

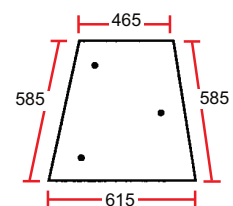

30/4047-6A
(3900618M1)
B18009 ⇒

Porte supérieure / Upper door

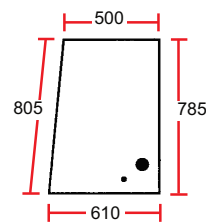

30/4022-10
(3476159M1)

Porte inférieure / Lower door

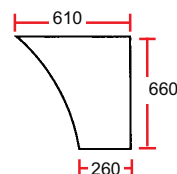

30/4022-11A
(3477778M1)

Avant / Front

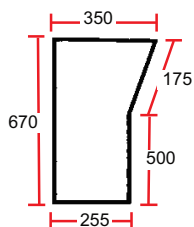

30/4010-4
(3475995M1)
Droite / RH

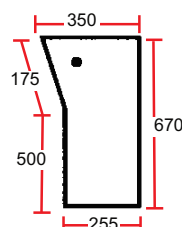

30/4011-4
(3475994M1)
Gauche / LH

Les références des pièces sont indicatives.
Nos pièces ne sont pas d'origine

Part numbers are quoted for reference purposes only.
Our parts and accessories are not original.

MF-444



"THE RELIABLE SERVICE"



Ed.1 (07/04)

**VITRERIE DE CABINE
CAB GLASS**

Séries 300 series

Carne noire - Toit rouge
Black cab - red roof

Vitres claires / Plain glass

Utilisez profilés / Use the rubber
70/4112-4 & 70/4110-12

Pare-brise / Windscreen

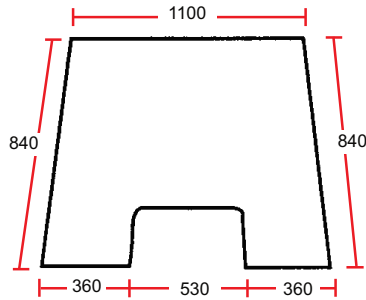

30/4000-18
(3475992M1)

Arrière supérieure / Upper rear

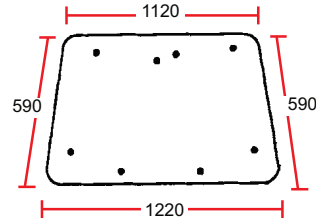

30/4072-4
(3476182M1)

Arrière inférieure / Lower rear

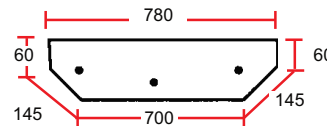

30/4073-3
(3476137M1)

Latéral / Side

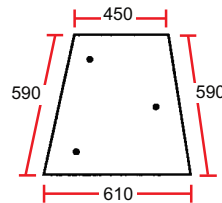

30/4047-6
(3476127M1)
⇒ B18008

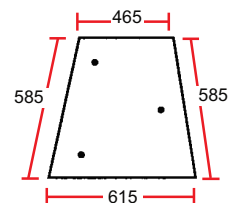

30/4047-6A
(3900618M1)
B18009 ⇒

Porte supérieure / Upper door

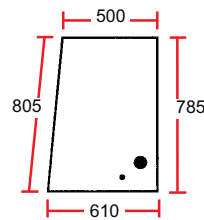

30/4022-10
(3476159M1)

Porte inférieure / Lower door

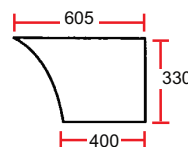

30/4022-11
(3476160M1)

Avant / Front

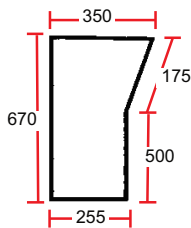

30/4010-4
(3475995M1)
Droite / RH

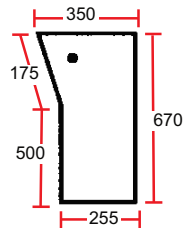

30/4011-4
(3475994M1)
Gauche / LH

Les références des pièces sont indicatives.
Nos pièces ne sont pas d'origine

Part numbers are quoted for reference purposes only.
Our parts and accessories are not original.



**VITRERIE DE CABINE
CAB GLASS**

Séries 500 series

Vitres teintées safi (*)
Tinted glass except (*)

Utilisez profils / Use the rubber
70/4110-9 & 70/4111-4

Pare-brise / Windscreen

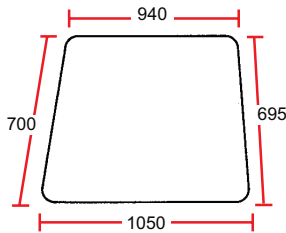

30/4000-19 (*)
(1670361M1)

30/4001-1T
(1670465M1)

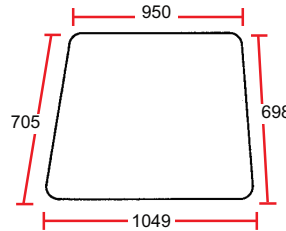

30/4000-43 (*)
Modèle scandinave
Scandinavian model

30/4001-5
Modèle scandinave
Scandinavian model

Arrière supérieure / Upper rear

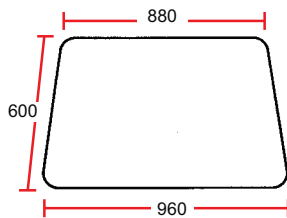

30/4072-6 (*)
(1699450M2)

30/4072-6T
(1665680M2)

Arrière inférieure / Lower rear

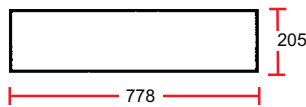

30/4073-4 (*)
(1699452M2)

30/4073-4T
(1665677M2)

Côté inférieur / Lower side

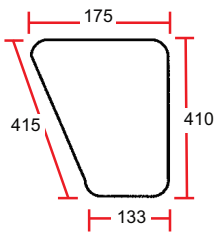

30/4049-1 (*)
(1699454M1)

30/4049-1T
(1665682M2)

Avant / Front

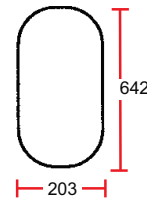

30/4012-13 (*)
(1699453M2)

30/4014-1T
(1665676M2)

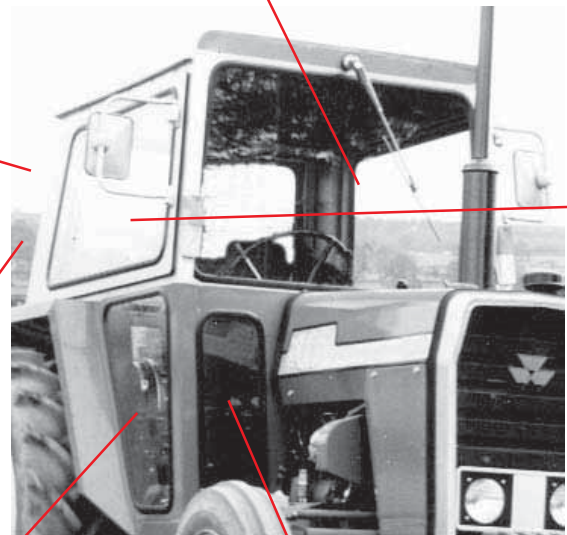

Les références des pièces sont indicatives.
Nos pièces ne sont pas d'origine

Part numbers are quoted for reference purposes only.
Our parts and accessories are not original.

MF-446



"THE RELIABLE SERVICE"



Ed.1 (07/04)

**VITRERIE DE CABINE
CAB GLASS**

Utilisez profilés / Use the rubber
70/4110-9 & 70/4111-4

Vitres teintées safi (*)
Tinted glass except (*)

Porte supérieur / Door upper side

1 partie fixe (gauche ou droite) / 1 fixed glass (RH or LH)

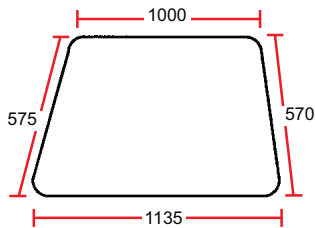

30/4048-1 (*)
(1699449M2)
30/4048-1T
(1665683M2)

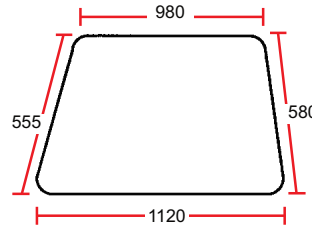

30/4080-4 (*)

Remplacez les vitres en 2 parties
Replacement for 2 parts glass

2 parties - fixe + coulissante (Droite) / 2 parts glass - Fixed + Sliding (RH)

Cabine Std Cab

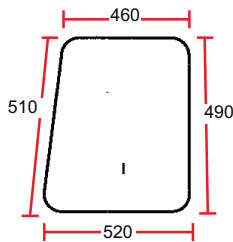

30/4051-2 (*)
(1875901M4)
Fixe / Fixed

30/4051-2T

Fixe / Fixed

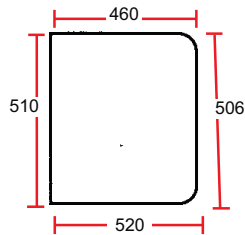

30/4050-2 (*)
(1875902M3)
Coulissante / Sliding

30/4050-2T

Coulissante / Sliding

Cabine A1 Cab

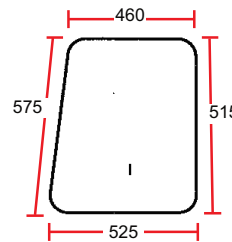

30/4051-1 (*)
(1698162M1)
Fixe / Fixed

30/4051-1T

(1665675M2)
Fixe / Fixed

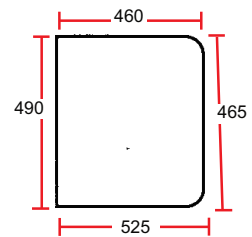

30/4050-1 (*)
(1698161M2)
Coulissante / Sliding

30/4050-1T

(1665674M2)
Coulissante / Sliding

Les références des pièces sont indicatives.
Nos pièces ne sont pas d'origine

Part numbers are quoted for reference purposes only.
Our parts and accessories are not original.



**VITRERIE DE CABINE
CAB GLASS**

Séries 600 series

Vitres teintées / Tinted glass

Utilisez profils / Use the rubber
70/4112-4

Pare-bise / Windscreen

30/4000-20
(3301875M3)

Arrière supérieure / Upper rear

30/4072-7
(3303023M2)

30/4072-8
(3306547M2)
Avec 2 trous
pour moteur d'essie-glace
With 2 wiper motor holes

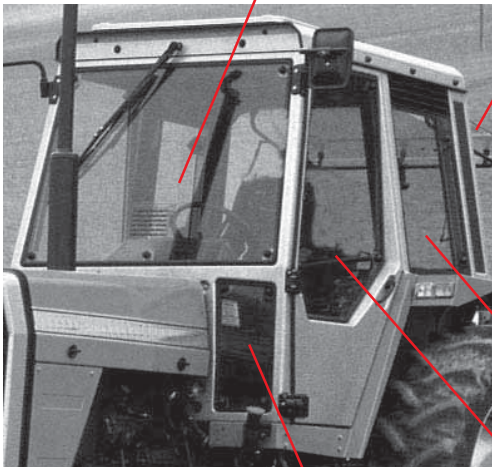

Arrière inférieure / Lower rear

30/4073-5
(3304534M1)

Avant / Front

30/4012-14
(3301879M3, 3301880M4)
Gauche & droit / LH & RH

Latéral / Side

30/4047-7
(3302705M5, 3302706M4)
Gauche & droit / LH & RH

Porte / Door

30/4020-8
(3301841M3, 3301845M4)
Gauche & droit / LH & RH

Les références des pièces sont indicatives.
Nos pièces ne sont pas d'origine

Part numbers are quoted for reference purposes only.
Our parts and accessories are not original.



**VITRERIE DE CABINE
CAB GLASS**

Séries 2000 series

Vitres teintées / Tinted glass

Cabne 2 portes / 2 door cab

Arrière / Rear

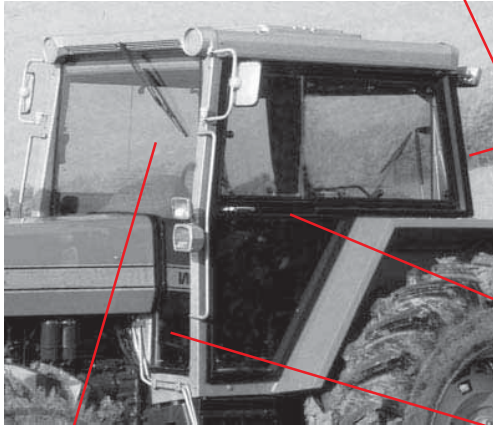
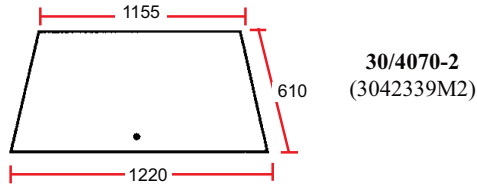

Pare-brise / Windscreen

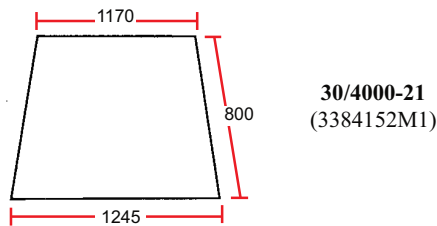

Avant / Front

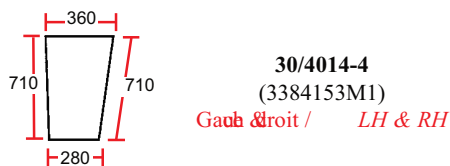

Côté gauche & droit / LH & RH side

Modèle standard / Standard model

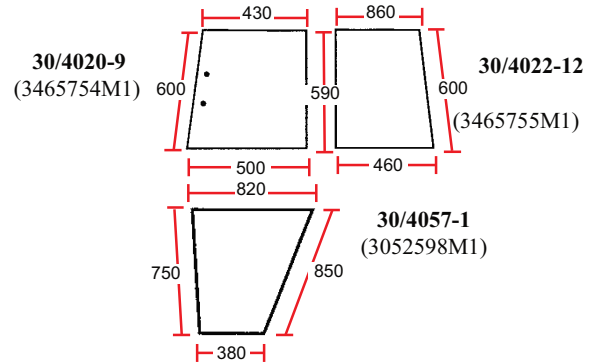

Cabine J271214 Cab

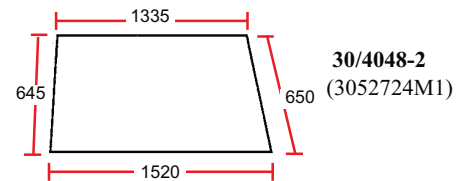

Où Or

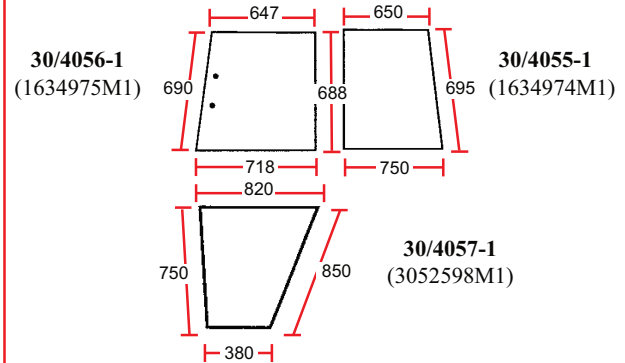

Les références des pièces sont indicatives.
Nos pièces ne sont pas d'origine

Part numbers are quoted for reference purposes only.
Our parts and accessories are not original.



**VITRERIE DE CABINE
CAB GLASS**

Séries 2000 series

Carne 1 porte / 1 door cab S271214 ⇒

Vitres teintées / Tinted glass

Arrière / Rear

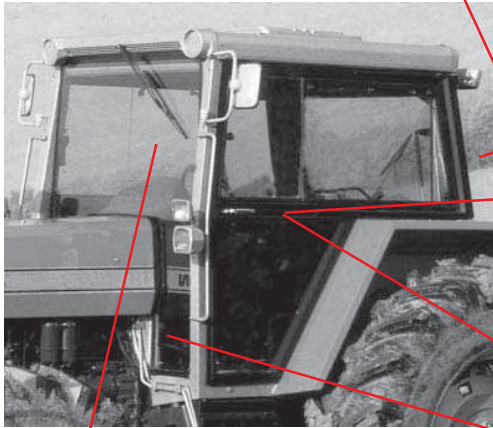
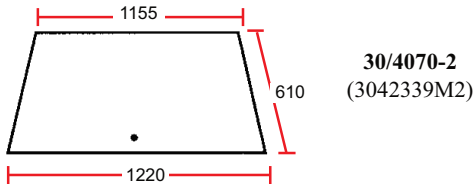

Côté gauche / LH side

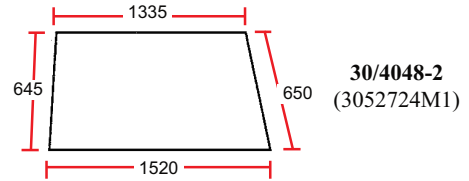

Où Or

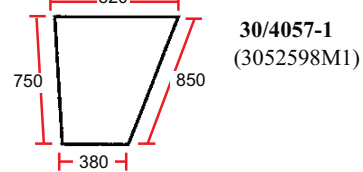
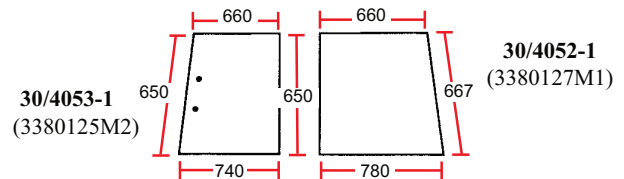

Côté droit / RH side

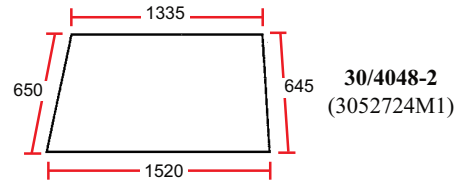

Où Or

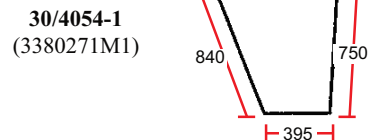
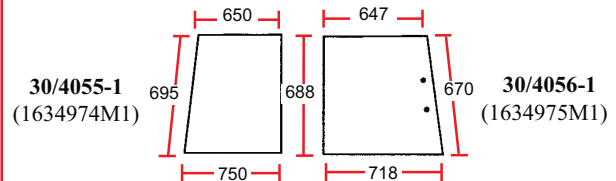

Pare-brise / Windscreen

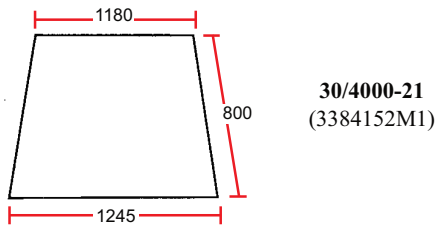

Avant / Front

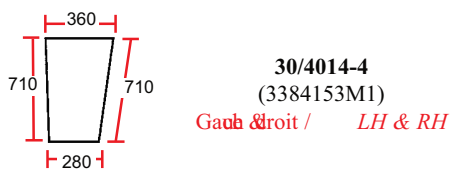

Les références des pièces sont indicatives.
Nos pièces ne sont pas d'origine

Part numbers are quoted for reference purposes only.
Our parts and accessories are not original.

MF-450



"THE RELIABLE SERVICE"



Ed.1 (07/04)

**VITRERIE DE CABINE
CAB GLASS**

Séries 2600 series

Vitres teintées / Tinted glass

Cabine 1 porte / 1 door cab J237208 ⇔ S271214
2620, 2640, 2680

Arrière / Rear

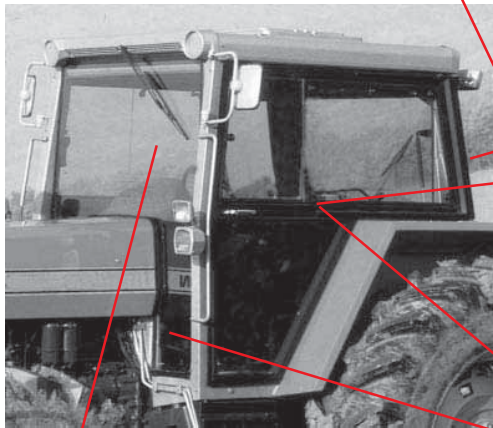
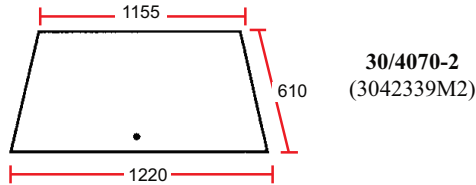

Côté gauche / LH side

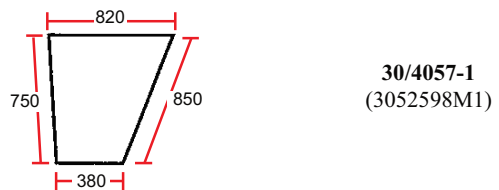
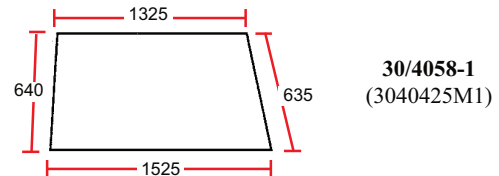

30/4056-1
(1634975M1)

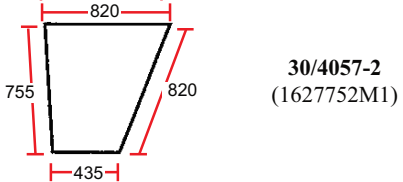
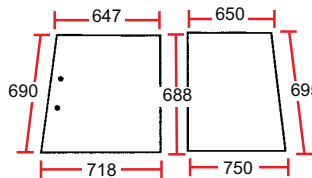

Pare-brise / Windscreen

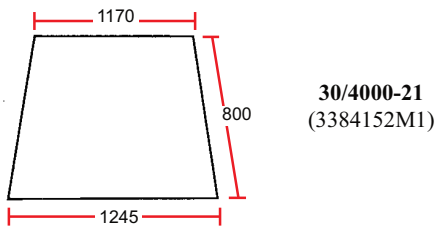

Côté droit / RH side

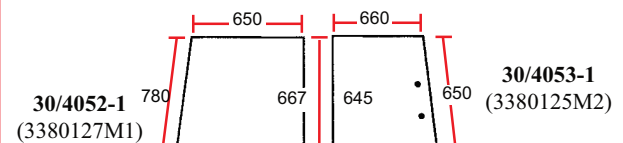

30/4054-2
(1634971M1)

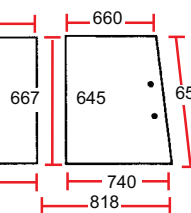

Avant / Front

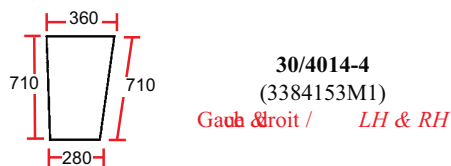

Les références des pièces sont indicatives.
Nos pièces ne sont pas d'origine

Part numbers are quoted for reference purposes only.
Our parts and accessories are not original.



**VITRERIE DE CABINE
CAB GLASS**

Séries 2600 series

Cabne 1 porte / 1 door cab ⇒ J237208
2640, 2680

Vitres teintées / Tinted glass

Arrière / Rear

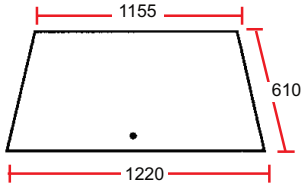

30/4070-2
(3042339M2)

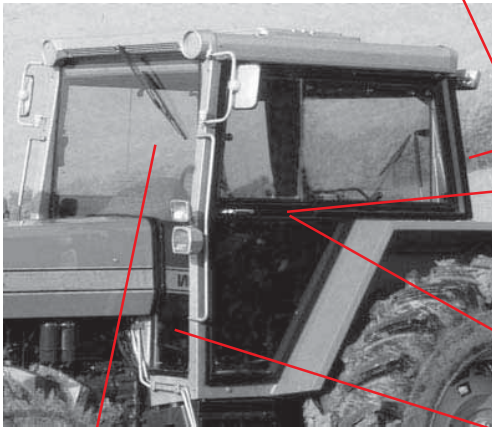

Côté gauche / LH side

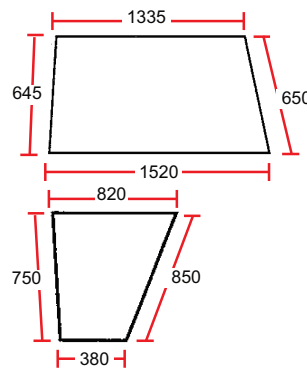

30/4048-2
(3052724M1)

30/4057-1
(3052598M1)

Côté droit / RH side

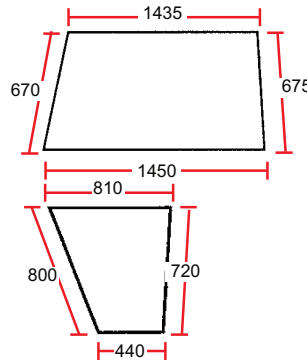

30/4059-1
(3042334M1)

30/4054-3
(1627756M1)

Pare-brise / Windscreen

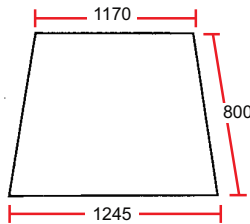

30/4000-21
(3384152M1)

Avant / Front

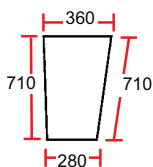

30/4014-4
(3384153M1)
Gauche & droit / LH & RH

Les références des pièces sont indicatives.
Nos pièces ne sont pas d'origine

Part numbers are quoted for reference purposes only.
Our parts and accessories are not original.



**VITRERIE DE CABINE
CAB GLASS**

Séries 3000, 3100, 3600 series

Vitres teintées / Tinted glass

Utilisez les profilés / Use the rubber
70/4112-4 & 70/4110-12

Pare-brise / Windscreen

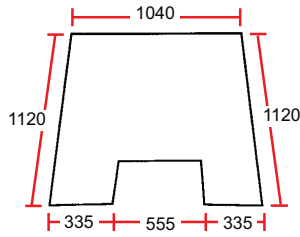

30/4000-23
(3385240M5)

Coin arrière / Rear corner

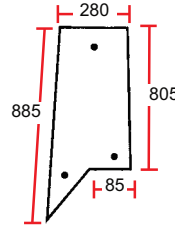

30/4047-8
(3389393M2)
Gauche & Droite
LH & RH

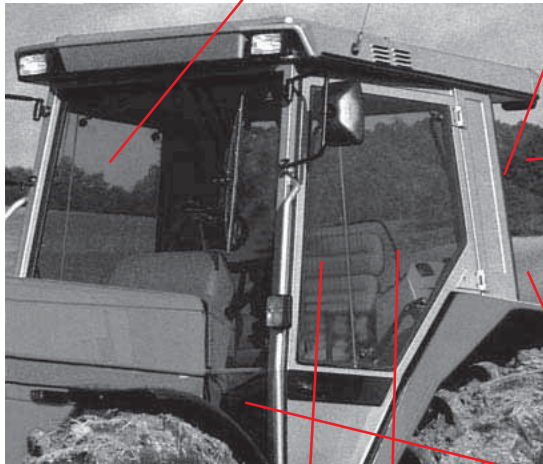

Arrière supérieure / Upper rear

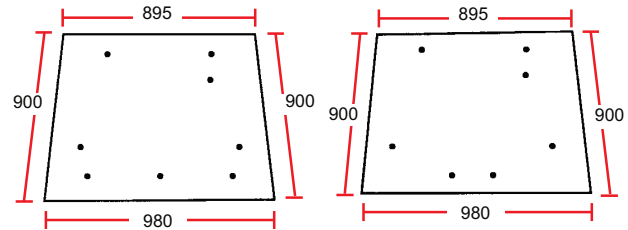

30/4072-9
(3389902M3)
⇒ C1360221
8 trous / holes

30/4072-9A
(3618433M2)
C1360222 ⇒
7 trous / holes

Porte / Door

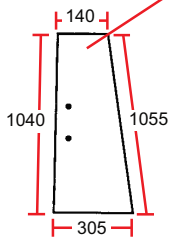

30/4026-1
(3389399M2)

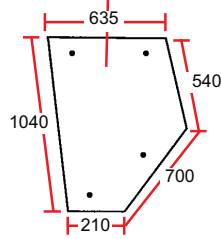

30/4027-1
(3389398M2)

Arrière inférieure / Lower rear

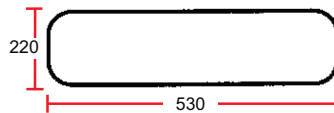

30/4073-6
(3389389M2)

Avant / Front

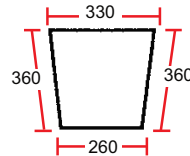

30/4012-15
(3389391M2)

Les références des pièces sont indicatives.
Nos pièces ne sont pas d'origine

Part numbers are quoted for reference purposes only.
Our parts and accessories are not original.



**VITRERIE DE CABINE
CAB GLASS**

Séries 4200 & 4300 series

Vitres teintées safi (*) / *Tinted glass except (*)*

Utilisez des profilés / *Use the rubber 70/4112-4*

Pare-bise / Windscreen

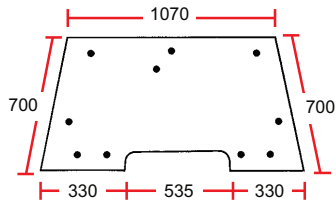

30/4000-71 (*)
(3806580M4)
Ouvrant / Opening

30/4000-73T
(3806704M4)
Ouvrant / Opening
4260 & 270 Versacab

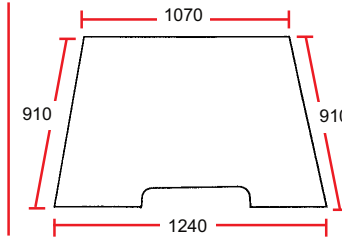

30/4000-70 (*) **30/4000-70T**
(3814953M1) (3814954M1)
Fixe / Fixed *Fixe / Fixed*

30/4000-72T
(3806573M1)
Fixe / Fixed
4260 & 270 Versacab

30/4000-74T
(3821747M1)
Fixe 2 trous / Fixed 2 holes



Coin arrière / Rear corner

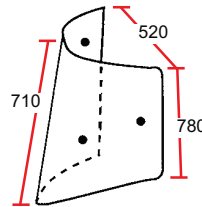

30/4069-4 (*)
(3804667M2)
Gauche / LH

30/4069-3T
(3806590M2)
Droit / RH
4260 & 270 Versacab

30/4069-4T
(3806591M2)
Gauche / LH
4260 & 270 Versacab

Porte / Door



30/4038-9 (*)
(3804658M1)
Droit / RH

30/4038-9T
(3805642M1)
Droit / RH

30/4039-9 (*)
(3804659M1)
Gauche / LH

30/4039-9T
(3805643M1)
Gauche / LH

Arrière supérieure / Upper rear

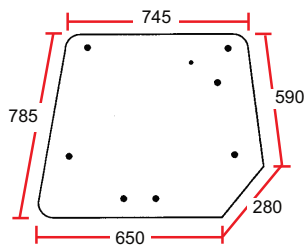

30/4072-44 (*)
(3804694M3)

30/4072-44T
(3806581M2)
4260 & 270 Versacab

Arrière inférieure / Lower rear

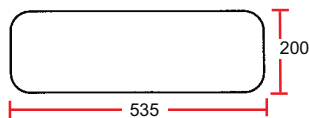

30/4073-27 (*)
(3804726M2)

Avant / Front

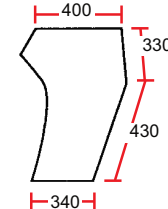

30/4012-49 (*)
(3806589M1)
Gauche / LH

30/4012-49T
(3806703M1)
Gauche / LH
4260 & 270 Versacab

30/4012-50 (*)
(3806588M1)
Droit / RH

30/4012-50T
(3806702M1)
Droit / RH
4260 & 270 Versacab

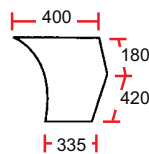

30/4012-37 (*)
(3804553M2)
Gauche / LH

30/4012-37T
(3806585M2)
Gauche / LH
4260 & 270 Versacab

30/4012-40 (*)
(3804552M2)
Droit / RH

30/4012-40T
(3806584M2)
Droit / RH
4260 & 270 Versacab

Les références des pièces sont indicatives.
Nos pièces ne sont pas d'origine

Part numbers are quoted for reference purposes only.
Our parts and accessories are not original.



**VITRERIE DE CABINE
CAB GLASS**

Séries 6100, 6200, 8100 & 200 series

Vitres teintées / Tinted glass

Utilisez des profilés / Use the rubber 70/4112-4

Pare-brise / Windscreen

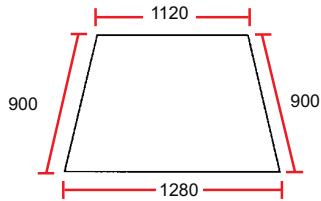

30/4000-56
(3902148M1)

30/4000-90
(3777602M2)
3 trous / 3 holes

Coin arrière / Rear corner

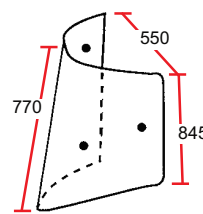

30/4069-7
(3902130M1)
Gauche / LH

30/4069-8
(3902131M1)
Droit / RH



Arrière / Rear

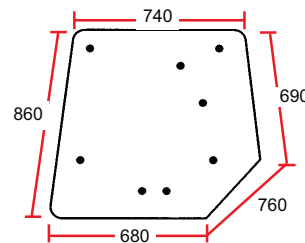

30/4071-22
(3902141M1)
⇒ E022024

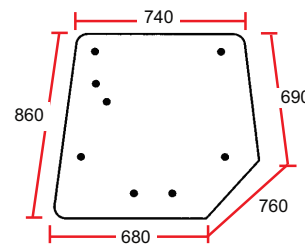

30/4071-23
(3715438M1)
E022025 ⇒

Avant / Front

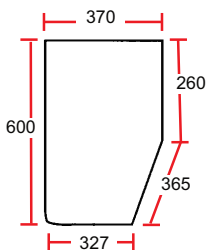

30/4014-6
(3902149M1)
Gauche / LH

30/4014-7
(3902150M1)
Droit / RH

Porte / Door

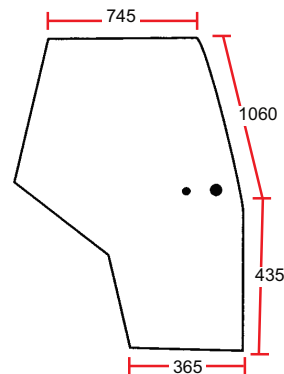

30/4038-2
(3902124M1)
Droit / RH

30/4039-2
(3902123M1)
Droit / RH

Les références des pièces sont indicatives.
Nos pièces ne sont pas d'origine

Part numbers are quoted for reference purposes only.
Our parts and accessories are not original.



REFERENCES INTERCHANGEABLES
CROSS REFERENCES

OEM OEM	Réf. Ref.	Page Page	OEM OEM	Réf. Ref.	Page Page	OEM OEM	Réf. Ref.	Page Page	OEM OEM	Réf. Ref.	Page Page
000851732	422-58	304	0910060	42-15	62,77	11125198	919-19	409	1425330M2	6678-19	387
000946740	411-48	313	0910061	43-15	62,77	1142116X1	376-22	296	1425332M1	153-112	163,165
000992344	410-45	313	0920113	118-1	129	115741F	32-1	44	1425333M1	154-212	163,167
001031690	161-104	185	0921062	16-1	32-36,38-40	1190	305-3	275	1425338M1	6682-16	387
001197710	15-13	32-34	0921173	118-2	129	126920	491-12	336,338	1425344M1	6679-16	387
001651U91	145-9	154	0921176	114-1	129	127A45	920-17	399,400,401,403	1425346M1	6679-17	387
001686U91	2930-57	172	0994658	130-136	132,138	127A45	920-81	400	1425347M2	6682-17	387
001696U91	1563-1	437	0994946	82-3	95,103	127A45	920-82	400,401	1425411M91	240-22	185
0040021	6441-2	361	0994967	91-2	108,111	13535X	528-5	350	1425418M1	240-23	185
0040040	261-1	245,249,250,265	0995260	102-1	119	1420037M1	1955-245	212-215	1425422M1	9604-130	92
0050119	28-1	32,33,39,40	0995447	83-3	94,102	1420222M1	6489-10	353	1425466M1	9604-130	92
0050128	28-8	34,38,40	1000251M1	618-1	375-378	1420377M91	161-38	186	1425492M92	648-8	380
0050265	84-5	108,111	1004498M1	102-1	119	1423262M92	177-52	201	1425495M92	640-29	368
0050345	84-8	95-100,102-104	1004633M1	306-2	255-260,276	1423444M1	6403-1	354	1425496M2	648-6	380
0070078	144-2	141,142,151-153	1004637M1	311-1	269	1423467M93	200-402L	224	1425497M2	6637-4	380
0070106	144-3	141,142,151-153	1005510M1	419-1	301,302	1423468M91	200-403L	224	1425614M91	172-36	194
0070108	144-4	141,142,143,150	100652	43-19	62,77	1423473M94	231-61	224,229	1425790M91	176-36	199
0070110	144-21	141-145,151-153	1007242M1	6444-4	361	1423482M1	430-6	308	1425872M91	177-53	201
0070172	144-2	141,142,151-153	1012006M2	111-2	173	1423566M1	9604-130	92	1425874M91	181-47	210
0070178	144-13	145,147	1012013M91	933-2	423	1423567M1	554-2	274	1425878M91	953-13	203
0070190	144-4	141,142,143,150	1013166M2	242-1	269	1423617M91	421-8	301	1425883M93	1918-60	212
0080068	101-10	117,118,120	1015997M91	932-3	423	1423618M91	417-29	301	1425884M93	1918-61	212
0095315	113-1	129	101661	42-1	62,77	1423630M2	485-30	333	1425885M92	1912-14	214
0095250	26-1	32,33,39,40	1017327M1	574-2	175,177,188	1423636M1	486-6	331,332,333	1425886M92	1912-15	214
0150142	151-1	155	1018551M91	168-4A	193	1423679M3	303-12	279	1425984M91	4114-14	439
0200009	142-8	131,138,140	1018554M91	169-11	193	1423682M3	301-6	279	1426114M1	6452-17	358
0200080	141-4	132,138,140	101871	42-19	62,77	1423693M91	712-26	391	1426389M92	221-96L	229
0201562	142-2	132,138,140	1019235M1	574-3	173,175,188	1423696M2	6678-18	389	1426390M94	212-59	229
0202016	141-3	131,138,140	1021314M91	420-1	301	1423697M92	760-62	398	1426390M94	212-59L	229
02100284	97-2	175-188	1021790M1	254-1	269	1423711M92	760-61	398	1426450M91	162-64	185
0230001	46-1	70,71,75,76	1021910M91	60-1	116	1423721M91	762-42	398	1426451M91	161-105	185
0410132	12-10	20,28	1021910M91	60-22	116	1423748M1	346-10	283-284	1426462M91	240-24	185
0410134	82-1	94,102	1022537M91	2930-102	172	1423769M91	177-45	201	1426565M1	9604-130	92
0410227	82-2	95,103	1022538M91	2930-102	172	1423852M91	181-41	210	1426603M1	1919-35	212
0410231	81-2	95,103	1022883M1	574-14	177,186,187	1423870M92	1931-33	216	1426605M1	1919-36	212
0410236	15-1	32-34,38-40	1022902M1	203-1	238	1423896M91	186-16	208	1426607M1	1913-12	214
0410241	81-1	94,102	1024026M1	911-2	410	1423997M91	712-27	391	1426609M1	1913-13	214
0410242	15-5	34,35,38,40	1024027M91	912-2	410	1424000M91	740-42	394	1426683M1	6679-17	387
0410264	15-5	34,35,38,40	1024034M91	913-2	410	1424008M91	740-43	394	1426921M92	7600-25	381
0420002	41-3	61,62,68,69	1024251M1	219-1	238	1424089M1	6637-2	380	1427013M92	1980-17	434
0450035	83-1	95-100,102-104	1024386M1	112-1	130	1424103M92	973-2	204	1427093M91	4170-89	436
047004	88-1	107	1025569M91	161-38	186,187	1424104M92	962-9	207	1427094M91	4170-90	436
0490481	66-1	168	1028265M91	495-71	336,339	1424105M92	1912-112	214	1427130M92	870-64	430
0490491	74-5	82,89	1028268M91	497-26	336,339	1424106M92	1912-113	214	1427157M91	871-26	430
0490580	73-3	82,89	1028657M1	220-1	238	1424107M92	1918-59	212	1427251M91	851-2	438
0490689	73-6	83	1028668V92	497-26	336,339	1424108M92	956-10	203	1427274M1	153-218	160,165
0490704	74-6	83,90	102968	32-40	44	1424109M92	950-36	203	1427275M1	154-211	160,167
0490724	74-7	83	1032762M91	161-63	174	1424118M91	964-14	209	1427342M1	303-82	279
0490770	74-13	84,90	103368	45-1	71	1424123M94	221-411	224	1427397M93	198-8	217
0510525037	565-48	368	103369	44-1	71	1424123M94	221-411L	224	1427398M93	198-9	217
0510525043	565-48	368	1034065M92	97-3	177-180,185-187	1424135M93	212-55	224	1427441M1	6641-2	387
0510525317	565-52	368	1034964M92	241-1	269	1424135M93	212-55L	224	1427448M1	6451-15	358
0510525339	565-52	368	1035408M92	161-95	177	1424149M95	221-412	224	1427449M3	6450-16	358
0510525345	565-52	368	1037927M91	574-14	177,186,187	1424149M95	221-412E	224	1427504M95	165-111	171
0510665389	565-75	369	1039072M1	110-18T	130	1424149M95	221-412L	224	1427506M96	165-112	171
0521220106	7611-6	381	1039161M91	574-14	177,186,187	1424273M91	7600-25	381	1427799M94	165-147	170
0521220139	7611-6	381	1042412M91	161-41	187	1424282M2	387-9	296	1428748M91	161-60	177,185,187
0530002	36-3	43,44,53,57	1042956M1	6410-20	358	1424346M1	1919-40	212,213	1429021M1	6403-2	354
0530015	35-20	49,57	1044526M2	420-26	301	1424354M1	1913-118	214	1429483M91	940-9	421
0530017	35-3	43,44,57	104628	376-11	290	1424357M1	1913-118	214	1433260M2	163-55	190
0530024	35-4	43,44,51,57	104662	11-15	21,29	1424368M1	6637-2	380	1433650M92	162-25	177-180,184-187
0650563	21-32	31	1047083M91	940-6	421	1424422M91	341-23	283	1434732M2	163-60	190
0650566	21-17	31	105138	41-10	62	1424463M1	649-5	380	1434760M1	440-33	314,320
0650576	21-25	31	1052097M1	574-2	175,177,188	1424502M3	6637-3	380	1440054X1	440-35	314
0650577	21-38	31	1052441M91	939-13	422	1424533M2	154-210	160,167	1440215X1	441-33	314,319,320
0650618	21-35	31	1052443M91	931-8	423	1424534M1	154-215	163,167	1440231X1	443-6	315,316
0650664	21-22	31	1062501M91	161-25	177,178,180	1424578M94	470-38	329	1440492X1	230-1	218-223,225-231
0650710	22-32	31	106387	71-1	83	1424579M94	470-37	329	1440511X1	372-66	298
0650712	22-38	31	106594F	35-1	44,57	1424584M2	480-20	329	1440546X1	372-54	295,296,298
0670321	59-1	399,406	1077260M91	111-3	130,173-188	1424599M91	566-113	368	1440547X1	372-25	295,298
0730071	13-2	22-24,26,27,29	1077260M91	111-5	130,173-188	1424916M3	387-10	296	1440550X1	372-26	295,298
0730080	13-1	20,21,28,29	1077452M1	305-1	275,276	1424974M2	480-19	329	1440559X1	304-18	279
0730098	11-12	21	1092639V1	2930-76	172	1425168M92	962-10	207	1440561X1	372-27	295,298
0780006	45-3	70,71,75,76	1093682M92	161-60	177,185,187	1425169M1	648-5	380	1440571X1	266-1	252,253,261-268
0780007	44-3	70,71,75,76	1093683M92	162-25	177-180,184-187	1425170M1	649-2	380	1440591X1	372-63	298
0780012	45-60	70,75	1094197M91	940-9	421	1425178M1	9604-130	92	1440593X1	372-28	296,298
0780272	45-4	71-76	1096475M91	162-41	187	1425197M1	9604-130	92	1440627X1	6440-3	361
0780273	44-4	71-76	109948	3-19	12	1425199M1	9604-130	92	1440635X1	354-6	362
0860012	54-2	78,81	110926	43-1	62,77	1425200M1	9604-130	92	1440636X1	354-19	361
0910001	42-3	61,62,68,69,77	11125122	919-21	409	1425202M1	9604-130	92	1440637X1	354-21	287,361,362
0910002	43-3	61,62,68,69,77	11125139	919-17	409	1425226M93	200-255L	229	1440639X1	354-32	288
0910030	42-16	63,66,69,77	11125177	919-3	409	1425227M91	231-62	229	1440640X1	354-16	288,295,298

Les références des pièces sont indicatives.
Nos pièces ne sont pas d'origine

Part numbers are quoted for reference purposes only.
Our parts and accessories are not original.



"THE RELIABLE SERVICE"



REFERENCES INTERCHANGEABLES
CROSS REFERENCES

OEM OEM	Réf. Ref.	Page Page	OEM OEM	Réf. Ref.	Page Page	OEM OEM	Réf. Ref.	Page Page	OEM OEM	Réf. Ref.	Page Page
1440642X1	353-5	362	1447384M1	143-18	141,142,144-153	1611096M1	486-43	353	1635999M1	851-7	438
1440644X1	352-24	289,296	1447391M1	117-41	127,128	1611264M1	476-16	327,328	1636924M3	240-28	177,178
1440645X1	353-17	362	1447407M91	144-204	147,150	1612260M92	165-120	171	1638480M91	832-1	429
1440648X1	354-23	362	1447417M91	144-13	145,147	1612487M1	9604-130	92	1639080M91	460-1	323
1440651X1	352-13	288,361	1447418M91	144-102	147	1612560M1	354-28	287	1639081M91	460-5	323
1440755X1	6489-11	353	1447419M91	144-36	147-149	1612561M1	354-28	287	1639082M91	460-2	323,334
1440826X1	353-13	361	1447474M1	117-34	126,128	1612571M1	353-22	287	1639083M92	224-2	239
1440860X1	2940-080	154	1447481M91	58-7	200	1613002M3	172-12	194	1639316M1	1920-8	215
1440873X1	6284-7	268	1447483M91	90-2	108,111	1613684M92	172-11	194	1639363M91	923-10	409
1440895X1	371-40	295	1447535M91	100-25	118,120	1613986M4	226-12	240	1639386M91	97-3	175-188
1440912X1	6412-4	357	1447582M91	100-19	117,120	1613986M4	410-6	311	1639424M1	162-98	175,177
1441048X1	372-67	298	1447633M91	920-5	406,407	1614707M3	186-15	208	1639428M91	574-4	175-177,188
1441176X1	6489-10	353	1447652M1	47-67	71,74,75,76	1614787M1	920-17	399,400,401,403	1639938M91	460-3	323,334
1441250X1	353-6	362	1447658M1	117-43	127,128	1614787M1	920-82	400,401	1640957M91	131-1	132,138
1441256X1	305-21	279,298	1447681M1	261-1	245,249,250,265	1614787M1	920-92	920-92	1640994M91	96-1	173
1441406X1	372-52	295,298	1447689M1	11-10	20,21,28,29	1617695M1	265-4	252	1640995M91	111-1	173,187
1441546X1	6409-7	357	1447690M1	11-11	22-30	1617778M1	355-7	361	1640996M91	96-2	173-175,182
1441550X1	6420-1	358	1447691M1	13-4	20-30	1617784M1	354-1	286,287,361	1641016M1	55-2	107, 155-164
1441554X1	446-31	320	1447693M91	100-6	117,118,120	1617785M1	354-1	286,287,361	1641103M91	100-17	117
1441815X1	6407-43	297	1447695M91	144-101	146,147	1617787M1	353-7	358,361,362	1641140M1	97-43	175
1441835X1	352-21	288	1447696M91	144-103	148	1617796M1	352-14	361	1641148M1	97-43	175
1441885X1	6409-6	357	1447698M1	930-11	411-420	1617797M1	352-14	361	1641173M1	73-4	82,89
1442008X1	352-23	323	1447698M1	930-5	411-420	1617813M1	353-7	358,361,362	1642034M91	227-12	240
1442067X1	372-29	296,328	1447698M1	930-80	411-417,419,420	1617826M94	497-18	341,342	1642034M91	411-6	311
1442208X1	6489-7	352	1447701M91	920-11	401,402,410	1617829M1	495-40	341-343	1642923M1	9604-143	92
1442216X1	376-22	296	1447706M91	920-5	406,407	1617846M1	6451-16	358	1643314M91	920-10	401,402,406-410
1442218X1	6489-7	352	1447706M91	920-69	406,407	1617849M1	9604-130	92	1643314M91	920-4	401,402,406-410
1442219X1	6444-3	361	1447706M91	920-24	406-408	1617854M1	6462-16	297,357	1643314M91	920-11	401,402,410
1442250X1	6409-2	357	1447706M91	920-101	407	1617890M1	6285-1	267	1643314M91	920-108	401-405,407,408
1442252X1	6412-1	357	1447723M1	89-6	114,115	1617892M1	6286-2	267	1644333M1	161-26	178
1442253X1	354-7	358,361	1447727M91	89-5	114,115	1617893M1	6286-1	267	1644334M1	162-26	178
1442254X1	6410-1	297,360	1447732M1	930-38	416-418	1617894M1	6286-3	267	1644435M91	6440-1	366
1442255X1	6410-2	297,360	1447752M1	84-11	99,108,110,111	1617923M3	280-2	262,268	1645894M91	574-21	175,177
1442381X1	231-68	224,229	1447768M1	117-31	126	1618050M4	930-16	415	1645921M1	143-57	142
1442408X1	353-12	288,361,362	1447773M91	144-205	151	1618050R4	930-16	415	1645922M2	143-5	142-144,150-153
1442524X1	6452-13	358	1447778M91	144-22	143,144,151,153	1618260M93	760-44	398	1645929M91	421-9	301
1442530X1	372-70	298	1447784M91	144-206	141,143	1618473M91	920-17	399,400,401,403	1645957M1	1919-74	212
1442538X1	354-33	289	1447829M91	117-42	126,127	1618473M91	920-81	400	1645958M1	1919-74	212
1442550X1	353-7	358,361,362	1453886M91	103-2	122	1618473M91	920-82	400,401	1645959M2	1913-132	214
1442664X1	376-27	298	1456340M93	640-10B	369	1618473M91	920-92	920-92	1645960M2	1913-132	214
1442682X1	6452-15	358	1458485M1	153-37	164,165	1619032M1	15-7	35-37	1655042M91	101-58	119
1444542X1	372-50	295	1458875M91	173-1	197	1619886M1	953-1	203	1659768M1	486-48	352
1446022M91	47-60	70,71,75	1459214M92	150-17	160,164	1621205M1	181-3	210	1659783M2	6443-1	361
1446059M1	58-2	200	1470214M91	640-10	369	1621206M1	181-4	210	1659785M1	6442-1	361
1446108M91	186-17	208	1471734M91	920-5	406,407	1626989M92	422-8	303	1660050M91	700-10	388
1446116M91	950-2	203	1475790M91	165-2	170	1627752M1	4057-2	451	1660050M91	700-32	388
1446127M91	143-5	142-144,150-153	1476245X1	27-1	32,33,39,40	1627756M1	4054-3	452	1660051M91	702-4	388
1446130M1	131-2B	135	1477082M91	97-1	192	1628494M1	1955-453	216	1660053M91	703-3	388
1446155M91	100-6	117,118,120	1498008V1	2930-89	172	1630805M91	41-10	62	1660055M91	701-3	388
1446165M91	143-3	141-147,150-153	15024X	418-8	305	1630806M91	41-1	62,69	1660094M1	259-1	252,253
1446176M91	60-1	116	150662M11	463-1	323	1630925M1	110-16R	130	1660114M2	486-3	330,331,332
1446176M91	60-22	116	1508880M91	168-3A	193	1630944M91	421-9	301	1660209M92	615-3	377
1446222M91	143-4	142,147,150-153	1508881M1	169-6	193	1630967M1	1913-10	214	1660262M93	712-14	391
1446675M91	97-3	177-180,185-187	15221X	205-1	238,239	1630968M1	1913-111	214	1660263M93	712-13	391
1446701M1	117-96	126	1568	153-1	155,165	1630969M91	1912-117	214	1660288M91	303-16	276,277
1446702M1	117-6	126,128	15858X	372-3	291,292	1630970M91	1912-116	214	1660323M1	699-1	386
1446703M1	117-8	126,128	1604409M1	957-1	203	1632719M2	112-2	130	1660324M91	696-1	386
1446891M91	110-302	130	1604464M1	144-207	150	1632735M1	911-2	410	1660338M92	695-1	386
1446892M1	117-32	126,128	1606502M94	802-2	372	1632923M91	206-2	238,239	1660348M1	485-5	330,331,332
1446896M1	117-35	126,128	1606532M94	808-2	372	1632931M1	931-6	423	1660372M91	759-4	395
1446935M1	60-3	116	1606583M93	801-2	372	1632932M91	912-2	410	1660373M92	760-6	395
1446951M91	100-25	118,120	1606737M93	807-2	372	1632988M91	940-6	421	1660375M1	761-2	395
1447024M1	11-13	23,26,30	1606882M3	580-3A	370	1633118M91	227-12	240	1660406M1	321-1	280
1447031M1	97-3	177-180,185-187	1606890M91	585-4	371	1633118M91	411-6	311	1660438M92	760-15	397
1447048M1	97-2	175-188	1607427M91	804-2	372	1633223M1	240-28	177,178	1660439M1	671-1	384
1447049M1	13-3	20-24,26-29	1607721M91	805-2	372	1633266M1	9604-103	91	1660457M2	486-6	331,332,333
1447082M91	97-1	174-177,182-188	1608904M91	805-3	372	1633268M1	9604-113	91	1660498M91	150-4	155,164
1447109M91	920-4	401-410	1609086M91	585-26	372	1633270M3	9604-130	92	1660499M92	150-4	155,164
1447110M91	920-5	406,407	1610023M94	1988-2	434	1633281M91	1913-132	214	1660500M91	172-10	194
1447146M1	117-10	126,128	1610025M91	1987-16	435	1633282M91	1913-132	214	1660501M91	172-11	194
1447227M1	117-9	126,128	1610178M5	416-18	303	1633458M91	162-97	177	1660579M92	488-4	330,331
1447235M1	117-62	128	1610179M5	416-16	303	1633459M1	161-97	177	1660544M92	150-89	155
1447252M1	117-3	126,128	1610187M1	376-16	293	1633719M1	161-26	178	1660555M92	150-89	155
1447269M91	117-39	127,128	1610188M1	371-31	293	1633720M1	162-26	178	1660688M91	340-4	283
1447294M1	124-2	105	1610240M1	9604-130	92	1634224M1	1919-74	212	1660715M91	625-2	174-177
1447301M91	930-11	411-420	1610254M1	305-23	278	1634225M1	1919-74	212	1660769M91	449-3	321
1447301M91	930-5	411-420	1610311M2	9604-130	92	1634971M1	4054-2	451	1660842M98	300-1	280
1447301M91	930-80	411-417,419,420	1610378M1	9604-130	92	1634972M1	4052-1	450,451	1660905M1	376-15	291
1447312M91	920-10	401,402,406-408	1610449M2	9604-130	92	1634973M1	4053-1	450,451	1660916M91	278-2	261
1447312M91	920-108	401-405,407,408	1610606M4	906-3	395	1634974M1	4055-1	449-451	1660917M3	262-2	252,253
1447317M1	144-22	143,144,151,153	1610607M3	905-2	373	1634975M1	4056-1	449-451	1660919M1	285-1	263
1447381M91	100-7	117,118,120	1610613M1	9604-130	92	1635948M92	575-4	367	1661406M91	740-6	394

Les références des pièces sont

REFERENCES INTERCHANGEABLES
CROSS REFERENCES

OEM OEM	Réf. Ref.	Page Page	OEM OEM	Réf. Ref.	Page Page	OEM OEM	Réf. Ref.	Page Page	OEM OEM	Réf. Ref.	Page Page
1661408M1	746-3	394	1671773M3	6295-1	267	1676705M91	920-17	399,400,401,403	1682738M91	1912-121	214
1661409M1	743-6	394	1671828M1	6296-1	267,268	1676705M91	920-82	400,401	1682767M91	410-3	311
1661411M1	744-4	394	1671829M91	449-17	321	1676705M91	920-50	400,401,403,404	1682798M1	168-17	193
1661603M91	340-3	283	1671945M1	510-2	349	1676705M91	920-92	920-92	1682944M91	863-13	428
1661608M91	340-4	283	1672030M1	153-64	157,165	1677238M91	6292-1	267	1682950M91	841-5	426
1661794M92	172-7	194	1672095M3	6294-1	267,268	1677239M93	6292-2	268	1682953M91	841-4	426
1661908M91	920-1	399,400,403,410	1672251M92	600-2	374	1677386M1	186-26	208	1682977M1	956-11	203
1661918M91	695-1	386	1672335M1	510-4	349	1677724M1	251-2	249,250,251	1683301M92	600-2	374
1661930M1	165-1	170	1672626M1	317-1	265,280	1677738M1	255-9	249,250,251,266	1683341M2	6492-2	364
1662089M1	154-11	157,164,166	1672666M96	841-4	426	1677742M2	6283-3	266	1683757M91	340-3	283
1662224M2	265-19	253,267	1672725M1	163-4	190	1677827M3	278-10	262,268	1683796M3	165-1	170
1662242M2	393-1	280	1672755M1	961-1	209	1677828M2	6285-4	268	1683796M3	165-1S	170
1662243M91	570-1	367	1672762M93	6099-7	121	1677829M1	6283-5	268	1684022M1	6293-1	267,268
1662377M91	181-3	210	1672766M91	181-2	210	1677830M1	6295-2	268	1684272M1	1920-7	215
1662378M91	181-4	210	1672767M91	181-1	210	1677965M93	278-10	262,268	1684285M1	485-46	331,332
1662382M1	768-1	396	1672768M91	181-4	210	1677998M1	552-9	272	1684301M91	488-2	331,488
1662566M1	574-4	175-177,188	1672769M91	181-3	210	16779X	418-1	301,302,305	1684473M1	905-2	373
1662590M91	620-3	374	1672770M91	181-4	210	1678023M1	495-178	339	1684582M92	600-3	374
1662591M91	620-1	374	1672771M91	181-3	210	1678024M1	495-177	339	1684620M91	611-2	377,378
1662746M93	580-1	338,339	1672772M91	580-1	338,339	1678169M92	495-178	339	1684621M1	611-2	377,378
1662747M93	580-2	338,339	1672773M91	580-2	338,339	1678294M1	161-13	176,177	1684894M92	511-4	349
1663555M92	960-1	204	1672835M2	170-4	196	1678295M1	162-13	176,177	1684905M1	442-15	315
1663627M92	650-2	379	1672844M1	920-1	399,400,403,410	1678308M92	161-13	176,177	1684986M91	560-32	379
1663796M1	6290-1	267	1672859M1	920-80	399	1678319M92	449-3	321	1685067M1	6291-1	267,268
1664255M92	340-4	283	1672859M1	920-17	399,400,401,403	1678517M2	172-8	194	1686028M91	259-10	253,267
1664293M1	449-16	321	1672859M1	920-1	399,400,403,410	1678518M2	172-13	194	1686294M1	163-13	190
1664491M2	617-2	378	1672859M1	920-81	400	1678580M91	1918-69	212	1686359M1	317-8	280
1664509M1	650-3	379	1672859M1	920-50	400,401,403,404	1678582M92	1931-17	216	1686443M1	272-4	267
1664556M2	282-4	267	1672859M1	920-92	920-92	1678868M92	1912-10	214	1686467M91	262-10	253,267
1664633M92	570-11	367	1672862M91	150-15	155,160,164	1678869M92	1912-11	214	1686468M91	285-7	253,267
1665674M2	4050-1T	447	1672866M91	841-4	426	1678977M92	570-7	367	1686473M91	498-5	336,338-340
1665675M2	4051-1T	447	1672957M1	272-3	267	1678990M91	1918-56	212	1686614M91	144-208	144
1665676M2	4014-1T	446	1672994M93	165-28	170	1678991M91	1918-57	212	1686615M91	144-126	144,145
1665677M2	4073-4T	446	1673006M1	510-4	349	1679223M2	187-2	207	1686616M91	144-209	145
1665680M2	4072-6T	446	1673086M91	580-1	338,339	1679349M93	300-1	280	1686765M91	650-3	379
1665681M1	4001-1T	446	1673087M91	580-2	338,339	1679373M94	844-17	425	1686766M91	650-2	379
1665682M2	4049-1T	446	1673161M1	4075-9	440	1679374M94	844-16	425	1686767M91	650-4	379
1665683M2	4048-1T	447	1673200M1	4022-40	440	1679532M1	505-3	345,347,348	1686796M1	6294-1	267,268
1665684M91	692-19	386	1673201M1	4021-40	440	1679693M91	169-16	191	1686837M1	144-210	144
1665685M91	692-17	386	1673204M1	4047-58	440	1680033M1	682-4	385	1686883M1	144-211	146-148
1665737M91	690-4	386	1673327M1	4012-53	440	1680040M91	682-4	385	1687020M92	514-5	349
1665738M91	690-5	386	1673335M1	4000-78	440	1680061M91	610-1	374	1687042M91	625-2	174-177
1665962M91	677-1	384	1673443M1	4072-81	440	1680064M1	930-11	411-420	1687429M91	263-11	253,267
1666726M94	570-5	367	1673454M1	4074-9	440	1680064M1	930-5	411-420	1687430M1	281-5	262,268
1666727M92	570-5	367	1673663M91	514-14	349	1680064M1	930-80	411-417,419,420	1687531M1	144-211	141-145,151-153
1667052M93	109-4	130	1673835M92	165-27	170	1680065M3	930-10	411-414,416,420	1687562M1	168-17	193
1667175M1	424-5	307	1673840M91	1918-69	212	1680065M3	930-4	411-414,416,420	1687610M91	144-126	144,145
1667203M92	4170-18	436,437	1673841M91	1918-69	212	1680065M3	930-87	411-414,416,420	1687642M1	265-7	252,253
1667409M91	172-10	194	1674071M92	2935-54	172	1680065M3	930-90	411-414,416,420	1687643M1	265-8	252
1668816M2	953-1	203	1674073M91	1912-118	215	1680189M1	330-4	281	1687647M1	655-5	188
1668830M91	954-1	203	1674074M91	1912-119	215	1680260M2	165-1	170	1687817M91	841-5	426
1668901M1	4001-1T	446	1674491M92	580-1	338,339,370	1680263M1	906-3	373	1687819M91	841-4	426
1669648M95	150-16	156,157,164	1674492M92	580-2	338,339,370	1680334M91	1912-118	215	1688092M2	161-12	175,177,188
1669649M92	150-16	156,157,164	1674516M91	920-50	400,401,403,404	1680335M91	1912-119	215	1688093M2	162-12	175,177,188
1669650M94	150-16	156,157,164	1674517M1	920-50	400,401,403,404	1680361M91	1988-2	434	1688094M1	161-78	176,177,188
1669729M93	150-91	156,157	1674526M1	920-17	399,400,401,403	1680523M92	165-29	171	1688095M1	162-78	176,177,188
1669802M94	150-91	156,157	1674526M1	920-1	399,400,403,410	1680529M92	165-156	171	1688127M1	275-3	264
1669805M1	153-66	156,157,165	1674526M1	920-82	400,401	1680547M92	150-15	155,160,164	1688128M1	6313-1	264
1669806M1	154-66	156,157,166	1674526M1	920-50	400,401,403,404	1680599M92	150-94	157	1688129M1	6314-1	264
1669923M1	144-6	143,144,151,153	1674526M1	920-92	920-92	1680734M91	150-91	156,157	1688130M1	6315-1	264
1670234M91	221-64	224,228,230	1674637M92	176-16	199	1680871M91	221-3	219-228	1688131M1	6312-1	264
1670260M1	161-12	175,177,188	1674638M92	176-15	199	1680877M92	165-29	171	1688132M1	6311-1	264
1670261M1	162-12	175,177,188	1674668M3	6289-1	266	1680921M2	860-19	428	1688142M91	161-14	176,177
1670361M1	4000-19	446	1674984M92	655-4	174-177,188	1681509M1	153-65	157,165	1688171M6	165-26	171
1670417M1	491-32	336,338	1675125M92	600-2	374	1681789M91	615-5	378	1688187M91	221-66	224,227-229
1670465M1	4001-1T	446	1675274M1	266-1	252,253,261-268	1682387M91	760-21	397	1688207M91	221-70	227-229
1670732M91	426-7	307	1675390M91	165-27	170	1682388M1	6285-5	268	1688208M91	200-70	227-229
1670819M92	4170-57	436	1675753M92	471-40	327,328	1682448M1	265-7	252,253	1688216M91	144-125	147
1670820M92	4170-58	436	1675754M92	470-40	327,328	1682449M1	265-8	252	1688222M3	332-2	282
1670939M2	485-5	330,331,332	1675881M1	495-177	339	1682557M91	177-6	201	1688343M1	851-8	438
1670975M96	488-4	330,331	1675908M2	486-63	331,332	1682623M1	552-4	272	1688527M1	442-14	315
1671076M1	153-64	157,165	1676111M1	186-26	208	1682628M1	553-4	272	1688611M91	488-4	330,331
1671082M1	693-4	386	1676286M91	1918-74	212	1682629M1	553-3	272	1688635M91	165-29	171
1671174M93	570-9	367	1676286M91	1918-75	212	1682630M1	553-2	272	1688814M92	841-4	426
1671322M1	577-1	370	1676287M91	1918-73	212	1682631M1	553-1	272	1688988M1	144-212	141,142,145,152
1671335M1	500-2	346	1676287M91	1918-75	212	1682632M2	553-9	272	1689024M93	409-27	309
1671544M1	957-1	203	1676387M92	413-2	311	1682648M1	163-14	190	1689025M94	409-28	309
1671631M1	1987-9	435	1676470M91	2935-58	172	1682684M2	144-288	146	1690692M1	144-290	142
1671691M91	221-65	224,227-229	1676664M1	506-2	345,348	1682688M1	262-2	252,253	16908151	919-9	409
1671692M91	200-68	224,228,229,231	1676665M1	505-4	346,348	1682689M1	262-2	252,253	16908611	919-44	409
1671704M91	255-7	245-249	1676666M1	505-3	345,347,348	1682690M1	259-1	252,253	1690884M91	696-2	386
1671705M1	255-7	245-249	1676689M92	920-1	399,400,403,410	1682691M1	263-5	252,253	1690886M91		

**REFERENCES INTERCHANGEABLES
CROSS REFERENCES**

OEM OEM	Réf. Ref.	Page Page	OEM OEM	Réf. Ref.	Page Page	OEM OEM	Réf. Ref.	Page Page	OEM OEM	Réf. Ref.	Page Page
1690964M1	144-126	144,145	1696602M3	166-16	172	1754344M1	316-5	269	180854M91	760-1	395
1691156M93	570-6	367	1696603M3	166-17	172	1754345M2	317-7	269	180855M91	700-1	388
1691464M1	577-1	370	1696625M92	471-25	327	1754392M1	243-1	269	180855M91	700-35	388
1691618M92	449-3	321	1696626M92	470-25	327	1754394M1	253-1	269	1808585M1	730-7	393
1691795M92	920-50	400,401,403,404	1696648M91	409-2	309	1754395M1	257-1	269	180859M1+		
1691796M91	920-5	406,407	1696649M91	409-1	309	1754402M1	257-2	269	897677M1	730-4	393
1691798M1	510-4	349	1696663M91	560-2	379	1754520M91	310-1	269	180860M1	758-1	396
1691805M2	930-10	411-414,416,420	1696663M91	560-2D	379	1754521M1	311-1	269	1808629M91	560-29	379
1691805M2	930-4	411-414,416,420	1696665M91	570-14	367	1754523M1	322-1	269	1808749M94	200-67	224,228,230
1691805M2	930-87	411-414,416,420	1696721M1	479-45	327,328	1754525M1	312-1	269	1808769M91	221-64	224,228,230
1691805M2	930-90	411-414,416,420	1696815M94	108-4	124	1756481M1	202-1	238	1808819M1	440-32	314
1691806M1	930-11	411-420	1696816M97	108-9	125	180004M1	441-1	314,315,316	1808838M92	1918-74	212
1691806M1	930-5	411-420	1696817M93	108-1	123	180006M91	552-1	272	1808839M92	1918-73	212
1691806M1	930-80	411-417,419,420	1696818M94	108-7	125	180009M1	454-1	322	1808893M1	491-30	336,338
1692004M1	153-130	156,164,165	1696819M94	108-8	125	180010M1	451-1	322	1808974M92	268-3	254
1692144M1	491-19	336,338	1696972M91	2935-70	172	180018M1	686-1	385	180898M1	692-43	386
1692157M1	316-6	280	1698042M91	105-2	122	1802062M91	939-5	422	180901M91	334-1	282,389
1692490M1	144-6	143,144,151,153	1698131M2	860-17	428	180224M92	151-14	155-159	180905M1	336-1	282
1692496M2	6288-1	266	1698161M2	4050-1	447	1802857M2	532-1	350	1809095M2	144-13	145,147
1692497M1	6287-1	266	1698162M1	4051-1	447	1802961M1	913-2	410	180924M2	603-1	375-378
1692502M2	258-16	249,250,251,266	1698374M2	161-14	176,177	180313M1	308-4	275,276	180925M2	604-1	375-378
1692758M91	200-69	227,229	1698375M2	162-14	176,177	180344M1	486-1	330	180933M1	609-1	375-378
1692759M91	221-70	227-229	1698670M91	410-1	311	180345M1	477-1	325,334	1809348M2	844-26	424
1692871M1	153-68	157,165	1698675M2	161-98	175,177	180346M92	471-1	325	1809380M1	682-4	385
1692891M1	144-125	147	1698676M1	162-98	175,177	180349M92	470-1	325	1809381M1	682-4	385
1693129M1	168-6	193	1698679M1	161-13	176,177	180355M2	476-1	325,334	180940M1	616-1	375-378
1693236M91	920-11	401,402,410	1698680M1	162-13	176,177	180364M92	165-6	170	1809496M1	497-27	341,342
1693294M1	165-155	171	1698683M1	161-99	176,177,182	180381M91	491-1	336,338	1809676M91	497-27	341,342
1693367M1	186-27	208	1698684M1	162-99	176,177,182	180391M91	492-1	336,338,340	1809696M91	560-16	379
1693421M92	449-3	321	1698715M91	426-7	307	180408M2	267-1	254	180970M2	684-1	385
1693745M1	144-31	144	1699034M1	953-1	203	180414M1	269-1	254	180972M2	670-1	383
1693746M1	144-29	141-144,152	1699141M92	165-28	170	180415M1	280-1	261	180973M2	665-1	383
1693790M2	258-17	246,247,249	1699143M93	165-28	170	180416M1	263-1	252	180974M1	668-1	383
1693833K92	248-1	243,244	1699381M92	177-5	201	180419M1	281-1	261	1809769M91	221-64	224,228,230
1693833M92	248-1	243,244	1699448M1	4000-19	446	180432M1	6299-1	268	180979M2	672-1	384
1693855M1	164-8	169	1699449M2	4048-1	447	180434M1	249-1	243	180980M1	671-1	384
1693883M91	221-37	225-227	1699450M2	4072-6	446	180437M1	556-1	270,271	1810027M91	72-2	83,90
1693884M91	221-38	225-227	1699452M2	4073-4	446	180441M1	265-1	252	1810028M91	71-2	83,90
1693921M93	690-6	386	1699453M2	4012-13	446	180444M2	235-1	240	1810029M91	405-1	300
1693924M1	486-62	331,332	1699454M2	4049-1	446	180445M1	286-1	263,264	1810052M91	807-1	372
1693932M91	692-41	386	1699602M92	920-17	399,400,401,403	180449M1	236-1	240	1810054M91	808-1	372
1693943M93	181-7	210	1699602M92	920-81	400	180451M2	233-1	238,239	1810056M92	802-1	372
1693944M93	181-8	210	1699602M92	920-82	400,401	180461M1	301-1	275,276	1810083M91	3-18	12
1693945M93	181-8	210	1699602M92	920-92	400,401	1804689M1	169-19	193	1810084M91	3-18A	12
1693967M91	409-30	309	1699610M1	172-8	194	1804693M92	412-10	301	1810085M91	3-18B	12
1693985M94	760-21	397	1699779M1	161-13	176,177	1805045M2	161-100	174	1810086M91	3-18C	12
1693987M94	760-13	397	1699780M1	162-13	176,177	180511M2	550-1	351	181018M1	686-1	385
1694025M1	758-2	396	1699781M1	161-98	175,177	1805743M92	530-5	350	1810252M92	801-1	372
1694126M3	551-11	273	1699871M1	920-80	399	180576M1	510-1	349	1810291M91	655-2	174,175
1694127M3	551-12	273	1699871M1	920-17	399,400,401,403	180577M1+			1810293M91	804-1	372
1694233M91	471-5	325,326,334	1699871M1	920-1	399,400,403,410	195592M1	512-1	349	1810320M91	460-3	323,334
1694234M91	470-5	325,326,334	1699871M1	920-81	400	180579M3	551-1	273	1810335M91	420-1	301
1694358M1	967-52	205	1699871M1	920-82	400,401	180582M1	551-16	274	1810345M91	403-1	300
1694359M1	967-54	205	1699871M1	920-50	400,401,403,404	180583M1	551-15	272	1810348M91	403-1	300
1694361M1	967-60	205	1699871M1	920-92	400,401,403,404	180596M1	375-1	290	1810366M91	498-4	337-339
1694362M1	967-56	205	1699872M1	920-17	399,400,401,403	1805978M91	417-31	301	1810369M91	130-1	132,138
1694365M1	967-59	205	1699872M1	920-82	400,401	1805980M1	420-26	301	1810391M91	460-1	323
1694711M3	154-38	156,166	1699872M1	920-50	400,401,403,404	1805984M1	418-6	301	1810394M91	585-3	371
1694961M5	165-110	171	1699872M1	920-92	400,401,403,404	1805985M1	419-2	301,302	1810404M92	240-29	187
1694963M5	165-109	171	1699878M91	920-17	399,400,401,403	1805994M1	931-6	423	1810416M91	460-2	323,334
1694965M6	165-108	171	1699878M91	920-82	400,401	1806001M1	933-3	423	1810417M91	575-2	367
1694976M2	172-39	194	1699878M91	920-92	400,401,403,404	1806219M1	940-6	421	1810429M91	222-2	239
1694985M92	103-4	122	1699881M93	920-1	399,400,403,410	1806264M91	417-31	301	1810437M91	585-3	371
1695081M1	485-42	332	1712202M1	111-3	130,173-188	1806417M1	1919-38	212	1810467M91	621-2	376
1695146M1	144-33	147	1712202M1	111-5	130,173-188	1807255M1	161-63	174	1810496M91	805-1	372
1695209M1	967-57	205	1714844M1	983-1	93	1807257M1	161-3	175,188	1810503M92	561-1	379
1695143M1	710-4	389	17201X	462-3	323,334	1807258M1	495-71	336,339	1810509M91	575-3	367
1695444M91	560-1	379	1722011M1	6418-7	364	1807259M1	497-26	336,339	1810517M92	403-1	300
1695445M91	560-2	379	1748133M94	580-8	370	1807260M1	497-29	337,339	1810529M91	575-1	367
1695445M91	560-2D	379	1749440M1	311-1	269	180801M1	430-1	308	1810539M91	655-3	174-177,187,188
1695447M1	951-2	203	1749581M91	494-1	356	1808152M1	761-55	397	1810572M94	479-2	325,326,327,334
1695561M2	153-40	156,165	1750451M1	982-1	93	1808294M2	570-8	367	1810573M91	414-44	313
1695562M1	154-40	156,166	1751403M1	437-1	317	1808327M91	761-48	397	1810576M91	933-3	423
1695563M1	153-41	156,165	1753117M91	420-1	301	1808432M1	491-29	336,338	1810581M1	9604-102	91
1695564M1	154-41	156,166	1753745M1	215-5	238	1808435M91	492-25	337,338	1810589M1	9604-102	91
1695628M91	1918-63	212	1753746M1	215-5	238	1808449M2	930-10	411-414,416,420	1810590M1	9604-101	91
1695721M2	150-19	156	1753748M1	214-1	238	1808449M2	930-4	411-414,416,420	1810591M91	574-3	173,175,188
1695732M1	105-6	122	1753749M1	218-1	238	1808449M2	930-87	411-414,416,420	1810596M91	411-1	311,313
1695847M92	1912-122	214	1753751M2	216-1	238,239	1808449M2	930-90	411-414,416,420	1810618M92	575-3	367
1695868M1	154-39	156,166	1753753M92	212-1	218,219,221,230	1808481M91	961-10	209	1810678M91	606-4	375-378
1696241M92	908-5	373	1753965M2	204-1	238	1808525M1	950-2	203	1810680M93	621-6	378
1696559M1	153-38	156,165	1754316M91	241-1	269	180853M1	757-1	396	1810684M92	621-5	376,377

Les références des pièces sont indicatives.
Nos pièces ne sont pas d'origine

Part numbers are quoted for reference purposes only.
Our parts and accessories are not original.

REFERENCES INTERCHANGEABLES
CROSS REFERENCES

OEM OEM	Réf. Ref.	Page Page	OEM OEM	Réf. Ref.	Page Page	OEM OEM	Réf. Ref.	Page Page	OEM OEM	Réf. Ref.	Page Page
1810687M91	411-23	313	1823602M1	6462-15	297,357	184079M91	701-1	388	1850944M1	574-3	173,175,188
1810694M92	655-4	174-177,188	1823648M1	9604-130	92	184134M91	700-1	388	1851062M91	404-1	300
1810714M91	411-3	311	1823870M91	640-30	368	184134M91	700-35	388	1851063M91	404-1	300
1810743M91	933-3	423	182391M1	762-2	395	184171M1	233-8	307	1851095M2	55-2	107, 155-164
1810744M91	625-2	174-177	1824004M1	306-8	279	184176M1	380-1	299	1851388M91	462-24	334
1810748M91	411-41	313	1824403M91	495-34	336,339,341-343	184182M3	385-1	299	1851392M91	372-3	291,292
1810814M91	220-3	239	1824418M92	740-39	394	184196M1	384-1	299	1851399M1	240-29	187
1810815M91	219-3	239	1824474M92	640-30	368	184202M1	381-1	299	1851533M91	352-3	286,287
1810816M91	204-2	239	1824627M93	150-49	160	184225M91	702-11	388	1851617M2	581-1	336,338,339
1810817M91	202-2	239	1824628M91	151-29	160-163	184225M91	702-2	388	1851618M2	581-2	337-339
1810824M91	219-2	238	1824633M1	153-114	160,161,163,165	184272M2	440-3	314	1851650M92	212-1	218,219,221,230
1810825M91	220-2	238	1824634M2	154-209	160,167	184273M1	441-2	314,320	1851651M96	200-1	218,219,230
1810827M91	223-1	238,239	1824637M1	154-213	160,167	184334M1	426-1	307	1851651M96	200-1L	218,219,230
1810832M91	411-7	312	1824647M2	163-58	190	184346M93	760-4	395	1851652M92	212-1	218,219,221,230
1810833M91	411-46	312	1824661M1	9604-130	92	184347M93	760-3	395	1851653M91	103-1	122
1810834M91	227-5	240	1824683M2	357-4	288,289	184350M1	759-4	395	1851654M1	104-1	122
1810839M92	575-6	367	1824689M1	551-17	272	184353M1	761-3	395	1851668M1	221-91	218
1810849M91	411-4	311	1824718M2	370-10	295,298	184354M1	761-2	395	1851744M1	117-3	126,128
1810855M92	224-1	238	1824719M3	378-2	295,298	184356M1	710-2	389	1851749M1	144-2	141,142,151-153
1810857M92	224-2	239	1824722M3	370-11	295,298	184358M1	762-2	395	1851751M1	144-2	141,142,151-153
1810858M91	608-2	376	1824723M3	378-3	295,298	184359M2	685-1	385	1851752M91	85-2	106
1810859M91	608-4	377	1824899M1	303-77	279	184359M91	685-1	385	1851753M1	85-3	106
1810860M93	608-3	378	1825004M1	306-8	279	184361M91	700-33	388	1851764M1	55-2	155-157,160-164
1810861M91	475-2	325	1825006M1	9604-130	92,279	184361M91	700-6	388	1851786M1	101-57	119
1810862M91	475-3	325,326,327,334	182501M1	483-1	324	184362M92	702-3	388	1851799M91	463-2	323,334
1810881M91	414-43	311	1825031M91	172-30	194	184362M92	702-12	388	1851800M91	462-2	323,334
1810882M3	575-6	367	1825066M92	105-19	122	184382M92	341-4	283	1851890M1	111-3	130,173-188
1810909M91	218-2	239	1825070M91	103-14	122	184447M1	692-1	386	1851890M1	111-5	130,173-188
1810917M94	414-3	311,312	182510M91	497-1	337,338	184461M92	713-3	390	1851890M91	111-3	130,173-188
1810936M91	411-5	311	1825115M91	176-31	199	184462M92	713-4	390	1851890M91	111-5	130,173-188
1810950M91	641-3	188	1825118M91	180-4	208	184471M1	605-1	375	1852113M91	101-4	117,120
1810992M91	415-1	311,312	182519M91	498-1	336,338	184471MIASSY	605-1A	375	1852157M91	352-1	286
1810993M91	415-2	311,312	1825210M91	566-60	368	184472M93	600-1	374	185220M1	761-1	395
181102M92	212-1	218,219,221,230	1825212M91	566-61	368	184473M93	600-1	374	1852251M91	96-2	173-175,182
181103M1	211-1	238	1825234M1	645-2	380	184483M91	284-1C	264	185251M1	352-2	286,287
1811086M91	411-18	311	1825272M1	686-11	385	184542M91	221-1	218,219,221,230	185252M1	352-2	286,287
181118M1	220-1	238	1825287M2	685-8	385	184542M91	221-1L	218,219,221,230	1852781M1	240-29	187
181124M1	223-1	238,239	1825299M1	6677-5	387	184568M91	735-2	392	1853004M1	201-1	238
181169M91	303-76	275	1825307M91	6677-6	387	184592M1	234-1	240	1853019M91	117-4	126,128
181173M1	303-76	275	182534M1	492-2	336,338-342	184700M1	349-2	285	1854094M1	173-1	197
181204M92	303-1	275,276	1825353M1	9604-130	92	184742M1	383-1	299	1853097M91	173-1	197
181217M3	332-1	282	1825360M91	953-11	203	184770M3	273-1	254	1853098M91	533-2	350
181229M5	710-1	389	1825362M92	970-2	204	184876M1	439-2	316	1853112M1	525-1	350
181232M1	357-1	286	1825462M1	951-2	203	184891M91	702-14	388	1853115M1	541-1	351
181237M1	306-6	255-260	182554M92	759-1	395	184891M92	702-1	388	1853118M1	531-1	350
181247M1	350-1	285	182557M92	471-3	325	1850003M92	530-1	350	1853121M1	532-1	350
181249M3	349-1	285	182558M92	470-3	325	1850016M1	535-4	350	1853123M1	515-2	349
181260M1	440-1	314	182559M92	471-2	325	1850017M1	536-1	351	1853144M1	58-2	200
181275M1	348-1	285	182560M92	470-2	325	1850018M1	543-1	351	1853148M1	419-2	301,302
181276M1	351-1	285	182580M1	676-1	384	1850019M1	544-1	351	1853162M1	201-1	238
181277M1	347-2	285	182581M1	674-1	384	1850020M1	545-1	351	1853164M1	208-1	238,239
181313M91	830-611	429	182582M1	673-1	384	1850021M1	546-1	351	1853196M1	161-3	175,188
181324M1	832-1	429	182632M91	712-2	391	1850022M1	547-1	351	1853210M1	526-1	350
181326M1	831-1	429	182633M91	712-2	391	1850025M1	537-1	351	1853224M91	173-1	197
181328M1	446-1	319	182641M1	761-1	395	1850031M1	521-1	350	1853230M1	177-6	201
181344M2	766-1	396	182642M94	760-2	395	1850032M1	520-1	350	1853268M91	173-1	197
181345M2	767-1	396	182725M1	502-1	346,348	1850033M1	517-1	349	1853380M91	403-1	300
181349M1	768-1	396	182841M92	221-93	218	1850034M1	515-1	349	1853466M93	580-3	370
181363M1	331-1	281	182850M1	486-2	330	1850041M1	541-2	351	185400M2	440-1	314
181408M1	333-1	282	183021M2	476-2	325-328,334	1850053M91	516-1	349	1854020	60-1	116
181953M2	481-1	330	183037M1	284-1A	264	1850087M92	352-3	286,287	1854020	60-22	116
181982M1	668-1	383	183038M1	284-1B	264	1850088M91	372-1	292	1854040	60-1	116
1819841M1	686-10	385	183039M1	284-1C	264	1850090M92	354-1	286,287,361	1854050	60-2	116
1819877M1	9604-130	92	183040M1	285-1	263	1850092M93	176-1	198	1854102	60-3	116
181999M1	607-1	375,376	183054M92	278-1	261	1850093M93	175-1	198	1854125M1	60-23	116
1820418M1	354-18	296,298,361	183086M1	477-3	325-328,334	1850160M1	101-57	119	185464M1	315-1	265
182115M91	341-1	283	183088M2	330-1	281	1850168M1	102-1	119	185551M93	625-1	173,174
1821234M91	492-2	336,338-342	183129M2	232-1	238	1850207M1	405-1	300	185592M1	486-4	330,331
1821823M1	9604-130	92	183221M1	485-1	330	1850213M91	406-1	300	185775M1	352-3	286,287
1822233M1	649-1	380	183254M1	357-1	286	1850217M1	408-1	300	185776M1	352-3	286,287
1822235M1	648-5	380	183462M1	424-2	307	1850224M91	462-1	323	185777M1	354-1	286,287,361
	649-2	380	183615M93	703-2	388	1850293M92	169-17	191	185778M1	354-1	286,287,361
1822606M92	417-29	301	183617M1	730-8	393	1850377M96	173-1	197	185892M94	221-61	219
1822671M1	153-113	163,165	183619M92	703-1	388	1850450M2	111-1	173,187	1860009M91	255-1	245
1822732M93	174-17	196	183623M93	701-2	388	1850512M94	174-1	196	1860011M1	256-2	245-249
1823112M92	420-27	301	183630M1	765-3	396	1850517M1	543-2	351	1860018M91	176-11	198
1823560M1	6450-17	358	183630M1(2x)+			1850519M1	544-2	351	1860036M3	479-2	325,326,327,334
1823570M2	486-41	352	831263M1	765-4	396	1850544M1	55-2	107, 155-164	1860038M1	601-2	376-378
1823574M1	6421-1	361	183631M1	767-6	396	1850546M1	159-6	191	1860040M91	479-2	325,326,327,334
1823575M1	6452-11	358	184012M4	270-1	254	1850699M2	177-3	201	1860059M91	176-11	198
1823590M1	9604-130	92	184078M91	700-2	388	1850830M1	159-4	191	1860065M91	176-14	199
1823598M1	440-34	319,320	184078M91	700-36	388	1850909M91	352-2	286,287	1860093M2	930-11	411-420

Les références des pièces sont indicatives.
Nos pièces ne sont pas d'origine

Part numbers are quoted for reference purposes only.
Our parts and accessories are not original.



REFERENCES INTERCHANGEABLES
CROSS REFERENCES

OEM OEM	Réf. Ref.	Page Page	OEM OEM	Réf. Ref.	Page Page	OEM OEM	Réf. Ref.	Page Page	OEM OEM	Réf. Ref.	Page Page
1860093M2	930-5	411-420	1863053M94	760-13	397	1868285M3	930-80	411-417,419,420	1872025M91	570-1	367
1860093M2	930-80	411-417,419,420	1863054M1	761-9	397	1868353M91	354-2	286	1872449M96	600-2	374
1860114M91	610-1A	374	1863057M91	759-8	397	1868354M91	354-3	286	1872458M1	441-32	314
1860156M1	868-1	427	1863260M93	740-5	394	1868435M3	605-3	378	1872484M4	488-2	331,488
1860158M1	217-1	238	1863389M1	670-2	383	1868435MBASSY	605-3A	378	1872485M95	488-2	331,488
1860159M1	219-2	238	1863435M95	712-12	391	1868439M98	600-2	374	1873170M92	109-4	130
1860160M1	220-2	238	1863857M1	439-2	316	1868528M92	255-4	250	1873532M3	556-3	270
1860161M91	218-1	238	1863884M94	760-14	397	1868530M91	255-2	245,246,247,248	1873903M92	870-1	430
1860167M91	841-3	424,426	1863885M1	761-8	397	1868531M1	255-2	245,246,247,248	1873910M1	954-1	203
1860175M1	181-4	210	1863886M2	762-6	397	1868532M1	293-1	255-259	1873971M92	177-46	201
1860176M1	181-3	210	1863888M91	759-9	397	1868533M1	246-2	255-259	1874025M2	164-8	169
1860177M1	181-2	210	1864570M93	615-3	377	1868544M92	611-2	377,378	1874120M93	950-2	203
1860178M1	181-1	210	1864869M1	381-3	299	1868545M2	611-2	377,378	1874192M92	181-3	210
1860183M1	182-2	211	1865012M1	617-1	375-377	1868557M93	303-19	276	1874445M93	151-8	155,156,157,164
1860184M1	182-1	211	1865029M1	861-6	427	1868691M1	233-8	307	1874535M3	950-2	203
1860268M1	483-4	324	1865030M1	861-4	427	1868732M1	479-2	325,326,327,334	1874653M1	920-17	399,400,401,403
1860325M1	305-1	275,276	186519M1	314-1	265	1868741M1	607-3	378	1874616M1	920-1	399,400,403,410
1860374M2	154-5	155,164,166	1865460M1	865-1	427	1868778M1	308-4	275,276	1874616M1	920-81	400
1860408M2	491-2	336,338,340	1865461M1	861-6	427	1869119M1	661-3	383	1874616M1	920-50	400,401,403,404
1860412M2	491-3	336,338,340	1865534M1	164-8	169	1869218M1	712-4	391	1874616M1	920-92	400,401,403,404
1860428M91	358-1	286	1865836M91	212-6	219-223,225-228	1869219M1	721-2	390	1874653M93	920-1	399,400,403,410
1860503M93	372-24	291,292,293	1865911M95	482-1	324	1869279M1	246-6	255-259,268	1874681M91	920-1	399,400,403,410
1860564M2	491-19	336,338	1865974M1	940-36	421	1869289M91	712-10	391	1874709M1	962-1	207
1860565M2	491-19	336,338	1865974M1	940-4	421	1869458M92	650-2	379	1874758M92	920-81	400
1860594M91	747-2	394	1865976M91	950-2	203	1869514M1	153-11	155-157,164,165	1874893M92	196-16	191
186061M91	497-1	338	1865985M91	4170-18	436,437	1869630M1	485-3	330,331	1874894M92	169-16	191
186063M91	495-1	336,338	1866010M91	655-3	174-177,187,188	1869631M1	485-2	330	1874957M91	410-2	311,313
186065M91	497-30	337,338	1866042M93	221-3	219-228	1869633M1	485-3	330,331	1874964M94	150-14	157
186065V91	497-30	337,338	1866048M92	161-60	177,185,187	1869634M1	485-2	330	1874973M1	144-4	141,142,143,150
186066M91	495-2	336,338	1866071M1	261-1	245,249,250,265	1869665M1	317-1	265,280	1874995M92	145-9	154
1860773M1	556-2	270	1866260M1	318-3	280	186968M1	154-4	155,164,166	1875174M1	4012-13	446
186077M91	498-2	336,338	1866540M1	270-2	254	1869708M1	293-3	255,259,268	1875187M92	176-16	199
1860829M2	766-2	396	1866541M3	271-2	254	1869712M91	255-8	246,247,248,249	1875775M1	501-1	345
1860833M1	761-8	397	1866542M2	267-2	254	1869713M1	255-8	246,247,248,249	1875776M1	500-2	346
1860838M1	357-2	286,287	1866545M2	269-4	254	186976M1	144-3	141,142,151-153	1875889M92	177-6	201
1860840M1	761-8	397	186654M1	153-6	155,165	1869779M1	161-13	176,177	1875901M4	4051-2	447
1860867M5	250-5	243,244	1866557M2	273-2	254	1869780M1	162-13	176,177	1875902M3	4050-2	447
1860890M92	248-1	243,244	1866560M91	265-3	252	1869781M1	161-98	175,177	1875955M1	920-17	399,400,401,403
1860915M1	670-2	383	1866610M1	574-4	175-177,188	186986M1	477-3	325-328,334	1875955M1	920-1	399,400,403,410
1860936M1	721-2	390	1866689M98	6500-17	370	1869954M91	700-25	388	1875955M1	920-81	400
1860954M1	376-4	291,292	1866690R98	6500-17	370	1869954M91	700-36	388	1875955M1	920-82	400,401
1860959M1	424-1	307	1866946M1	867-3	427	1869966M98	610-1	374	1875955M1	920-50	400,401,403,404
1860963M92	417-2	302	1866947M1	867-7	427	1870004M92	310-5	280	1875955M1	920-92	400,401,403,404
1860964M2	422-1	302	1866948M1	867-4	427	1870074M1	317-1	265,280	1875956M1	144-6	143,144,151,153
1860965M2	423-1	302	1866949M1	867-8	427	1870075M91	700-1	388	1876063M1	163-54	190
1861020M91	426-2	307	1866951M1	867-6	427	1870075M91	700-35	388	1876289M93	177-51	201
1861024M1	551-15	272	1867082M91	303-20	275	1870149M2	265-4	252	1876307M1	163-59	190
1861071M1	867-6	427	1867084M91	303-1	275,276	1870151M2	265-3	252	1876390M92	505-1	345
1861106M91	372-38	292	1867085M91	303-90	275	1870152M1	265-3	252	1876391M92	506-1	345,346
1861240M1	231-16	218-223,225-231	1867192M91	530-2	350	1870199M92	625-2	174-177	1876423M91	165-28	170
1861240M1	231-1	218-223,225-231	1867243M1	710-4	389	1870200M1	293-1	255-259	1876532M94	6099-8	121
1861319M91	449-4	321	1867246M1	6285-2	267	1870220M93	659-1	383	1876534M91	105-2	122
1861364M91	841-2	426	1867250M1	6285-3	267	1870240M1	658-1	383	1876606M4	150-12	156,157,164
1861364R91	841-2	426	1867259M1	6283-4	267	1870287M95	488-2	331,488	1876607M1	150-12	156,157,164
1861365M91	840-2	426	1867275M1	552-15	272	1870306M93	658-1	383	1876607M91	150-12	156,157,164
1861374M91	842-2	426	1867386M91	212-6	219-223,225-228	1870342M1	261-1	245,249,250,265	1876608M3	150-13	157,160
1861380M91	177-47	201	1867388M91	212-16	239	1870538M93	268-4	254	1876649M1	164-8	169
1861392M3	762-5	397	1867423M1	270-2	254	1870763M92	615-5	378	1876670M1	144-5	141,152
186145M92	498-2	336,338	1867424M2	271-2	254	1870806M92	511-2	349	1877159M92	4170-18	436,437
1861583M1	537-2	351	1867425M1	267-2	254	1870857M1	321-1	280	1877242M2	4200-32	192
186164M94	471-7	326	1867428M92	200-61	219-227	1870858M1	311-2	280	1877717M93	171-3	197
186165M93	470-7	326	1867433M92	200-62	221,223,228	1870859M1	312-2	280	1877718M93	176-15	199
1861676M91	426-2	307	1867436M92	200-63	221,223,228,231	1870860M1	316-1	280	1877719M93	174-2	196
1861704M1	535-4	350	1867438M92	200-7	219-227	1870869M2	9604-130	92	1877721M92	186-1	208
1861746M1	163-4	190	1867440M91	200-7	219-227	1870879M1	317-1	265,280	1877731M92	180-4	208
1861789M91	172-2	194	1867445M91	200-8	220-228	1870934M1	686-3	385	1877748M92	177-46	201
1861844M1	861-6	427	1867690M2	233-1	238,239	1871433M2	930-10	411-414,416,420	1877760M1	177-46	201
1861986M2	331-1	281	1867851M3	710-3	389	1871433M2	930-4	411-414,416,420	1877794M2	4000-19	446
1862029M91	491-1	336,338	1867896M1	201-2	239	1871433M2	930-87	411-414,416,420	1877795M1	4049-1	446
1862063M1	761-3	395	1867906M1	481-3	330,331	1871433M2	930-90	411-414,416,420	1877796M1	4048-1	447
1862267M1	481-2	330,331,332	1867990M1	265-3	252	1871610M91	432-2	306	1877857M96	4170-57	436
1862289M2	317-1	265,280	1868003M91	200-9	222,223,226,228	1871721M91	150-4	155,164	1881442M91	96-3	173-177,182-187
186235M91	495-2	336,338	1868005M92	200-9	222,223,226,228	1871758M91	1912-116	214	188148M1+		
1862399M1	552-6	272	1868115M1	381-1	299	1871759M91	1912-117	214	188359M1+		
1862400M1	552-8	272	1868225M1	231-16	218-225,226-231	1871924M1	330-3	281	353957X1+		
1862401M1	552-7	272	1868225M1	231-1	218-223,225-231	1871925M1	330-4	281	491105M1	716-5	390
1862423M3	258-11	245,246,247,248	1868283M5	930-4	411-414,416,420	187193M91	703-2+		1881632M91	111-8	187
1862486M96	615-3	377	1868283M5	930-87	411-414,416,420		713-3+		1881804M91	130-1	132,138
1862488M95	615-3	377	1868283M5	930-90	411-414,416,420		713-4+...	390	1881805M91	130-1	132,138
1862805M1	861-10	427	1868283M5	930-10	411-414,416,420	1871948M93	850-1	438	1881931M91	372-4	291,292
1862807M1	164-7	169	1868285M3	930-11	411-420	1871972M1	1912-116	214	1882771M1	73-2	83,90
1862918M91	655-2	174,175	1868285M3	930-5	411-420	1871973M1	1912-117	214	1882916M1	96-3	173-177,182-187

Les références des pièces sont indicatives

REFERENCES INTERCHANGEABLES
CROSS REFERENCES

OEM OEM	Réf. Ref.	Page Page	OEM OEM	Réf. Ref.	Page Page	OEM OEM	Réf. Ref.	Page Page	OEM OEM	Réf. Ref.	Page Page
1882944M92	101-5	117,118,120	1885777M1	853-3	438	1895271M91	920-17	399,400,401,403	191855M4	655-1	174,175,177,188
1882982M92	840-1	426	1886135M1	574-1	174-177,188	1895271M91	920-1	399,400,403,410	192007M1	551-16	274
1882983M91	841-1	424,426	1886314M91	841-1	424,426	1895271M91	920-81	400	193066M1	768-1	396
1882984M92	842-1	424,426	1886315M91	840-3	426	1895271M91	920-82	400,401	193092M1	769-1	396
1882985M1	843-5	424,426	1886316M1	838-4	424	1895271M91	920-50	400,401,403,404	193181M1	766-1	396
1882986M1	844-26	424	1886557M91	497-1	337,338	1895271M91	920-92	400,401,403,404	193733M91	492-1	336,338,340
1882987M1	844-27	424	1886562M1	419-2	301,302	1895334M91	417-35	301	194606M91	491-1	336,338
1883116M91	159-4	191	1886634M91	268-3	254	1895352M1	923-2	410	194607M91	492-1	336,338,340
1883133M91	529-1	350	1886637M91	161-1	174	1895359M1	6403-49	365	194737M1	154-9	155-157,164,166
1883238M91	832-1	429	1886638M91	162-1	174	1895398M91	920-17	399,400,401,403	194738M1	153-7	155,164,165
1883239M91	831-1	429	1886656M91	1931-17	216	1895398M91	920-82	400,401	194739M1	153-8	155,165
1883258M91	96-2	173-175,182	1886670M1	159-5	191	1895398M91	920-50	400,401,403,404	194742M1	167-4	169
1883279M91	372-39	293	1886673M94	158-5	191	1895398M91	920-4	401,402,406-410	195123M1	462-3	323,334
1883287M91	96-15	186	1886682M91	161-60	177,185,187	1895398M91	920-92	400,401,403,404	195159M1	352-3	286,287
1883288M91	96-14	186,187	1887285M91	700-39	388	1895699M1	6403-5	354,365	195160M1	352-3	286,287
1883318M1	574-3	173,175,188	1887285M91	700-9	388	1895852M91	420-28	301	195175M1	479-1	325,334
1883333M92	449-3	321	1887286M91	702-12	388	1896000M91	96-3	173-177,182-187	195181M1	462-1	323
1883334M91	449-16	321	1887286M91	702-3	388	1896096M91	111-3	130,173-188	195182M1	462-1	323
1883335M3	449-2	321	1887372M91	760-12	397	1896096M91	111-5	130,173-188	195525M1	734-1	392
1883344M92	101-7	117,118,120	1887421M1	925-1	410	1896154M91	101-3	117,120	195363M1	6284-5	268
1883356M92	844-10	425	1887426M1	923-1	410	1896287M91	111-4	176-181,186-188	195453M1	302-1	261-268,275-277
1883356M92	844-11	425	1887574M91	161-3	175,188	1896287M91	111-6	176-181,186-188	195457M1	765-1	396
1883372M91	403-1	300	1887575M91	162-3	175,188	1896329M91	101-10	117,118,120	195490M1	447-1	319
1883373M1	839-6	424	1887953M91	932-4	423	1896434M91	101-10	117,118,120	195493M1	266-1	252,253,261-268
1883374M1	839-5	424	1887960M91	940-9	421	1896435M91	32-9	45,49,51	195494M1	252-1	243,265
1883385M1	832-1	429	1887963M91	933-3	423	1896437M91	32-12	45,49,55	195498M1	304-1	275,276
1883398M91	159-6	191	1887964M91	931-7	423	1896438M91	32-13	46,49	195500M1	6284-8	268
188359M1+			1887989M1	575-3	367	1896446M91	162-1	174	195501M1	256-1	245
188148M1+			1888288M91	96-14	186,187	1897110M91	920-5	406,407	195503M1	250-2	243
353957X1+			1888292M91	939-12	422	1897117M1	169-12	193	195505M1	261-1	245,249,250,265
491105M1	716-5	390	1888296M91	847-3	436	1897151M1	161-3	175,188	195506M1	305-1	275,276
1884002M91	4170-56	436	1888677M91	268-4	254	1897264M91	920-80	399	195507M1	277-1	261,262,265
1884003M91	4170-31	436	1888684M1	143-2	142,151,153	1897264M91	920-17	399,400,401,403	195508M1	231-16	218-223,225-231
1884098M1	13-13	21,29	188909M1+			1897264M91	920-1	399,400,403,410	195508M1	231-1	218-223,225-231
1884101M91	33-2	44,51,56	881727M1+			1897264M91	920-81	400	195513M1	325-1	281
1884123M1	42-2	62,69,77	881728M1+			1897264M91	920-82	400,401	195522M1	306-1	275,276
1884124M1	43-2	62,69,77	881729M1+			1897264M91	920-50	400,401,403,404	195523M1	250-1	243
1884125M1	45-2	71,76	375108X1+			1897264M91	920-92	400,401,403,404	195561M1	590-012	383
1884126M1	44-1	71,76	3534030X1	579-1	370	1897291M91	932-4	423	195565M1	687-1	385
1884245M1	545-2	351	1889498M1	940-6	421	189713M91	940-12	421	195589M1	704-1	389
1884278M92	158-5	191	1889567M1	535-8	350	1897314M91	932-7	423	195592M1 +		
1884281M91	403-1	300	1889777M91	340-3	283	1897315M91	931-9	423	180577M1	512-1	349
1884286M97	844-12	425	1889779M1	940-9	421	1897316M91	939-15	422	195644M1	763-1	396
1884287M97	844-13	425	1890038M1	940-6	421	1897375M91	1987-16	435	195677M1	371-1	290
1884289M1	454-1	322	1890147M1	112-2	130	1897453M91	920-5	406,407	195678M2	376-1	290
1884301M91	169-17	191	1890150M1	110-19	130	1897695M91	920-10	401,402,406-408	195742M1	167-4	169
1884302M91	169-15	191	1890154M1	181-4	210	1897695M91	920-4	401-410	195747M1	592-012	383
1884342M92	760-5	395	1890155M1	181-3	210	1897695M91	920-11	401,402,410	195910M1	431-1	308
1884374M93	580-3	370	1890156M91	181-2	210	1897695M91	920-108	401-405,407,408	195925M1	544-1	351
1884376M1	757-1	396	1890157M91	181-1	210	1897695M91	920-5	406,407	195949M1	617-1	375-377
1884576M91	831-1	429	1890318M1	419-7	302	1897695M91	920-69	406,407	196049M1	486-4	330,331
1884693M91	4170-18	436,437	1890319M1	407-1	300	1897695M91	920-24	406-408	196050M2	486-40	330
1884720M1	759-2	395	1890556M92	403-1	300	1897695M91	920-92	400,401,403,404	196057M1	487-4	330,331
1884724M91	712-2	391	1890716M1	181-2	210	1897702M92	921-8	410	196060M1	477-2	325
1884725M91	712-2	391	1890717M1	181-1	210	1897705M1	922-11	410	196079M1	504-1	345-348
1884736M91	111-2	173	1890727M91	530-6	350	1897724M1	4072-3	442,443	196082M1	503-1	346-348
1884738M1	145-5	154	1891218M91	851-1	438	1897726M91	871-3	430	196098M1	353-1	286,287
1884760M94	760-11	397	1891226M91	853-1	438	1897727M91	4170-55	436	196167M1	479-2	325,326,327,334
1884761M91	712-6	391	1891456M91	165-28	170	1897852M1	4047-5	442,443	196206M1	863-1	427
1884762M91	702-11	388	1893404M91	940-9	421	1897853M1	4012-11	443	200570	32-40	44
1884762M91	702-2	388	1893408M91	939-8	422	1897854M1	4080-3	442,443	200868	15-15	33,40
1884763M91	712-7	391	1893410M91	931-5	423	1897855M1	4000-16	442	202084	73-19	83
1884769M1	161-38	186,187	1893611M91	930-10	411-414,416,420	1897856M1	4012-12	442	205/04034	919-17	409
1884777M1	145-6	154	1893611M91	930-4	411-414,416,420	1897857M1	4022-9	442	215290070/1	461-53	323
1884857M91	100-2	117,120	1893611M91	930-87	411-414,416,420	1897858M1	4021-10	442	215391770	416-24	304
1884897M1	163-24	190	1893611M91	930-90	411-414,416,420	1897859M1	4073-172	442	215391780	416-21	304
1884940M1	35-2	44,51,57	1893614M91	940-6	421	1897860M1	4022-8	443	215590780	477-53	329
1884944M1	28-33	33,40	1893623M1	544-1	351	1897861M1	4021-8	443	2171	371-19	290
1885023M95	844-14	425	1893705M91	930-10	411-414,416,420	1897898M1	4000-15	443	21820075	59-1	399,406
1885024M95	844-15	425	1893707M91	940-9	421	1897910M1	1987-9	435	21820104	18-1	31
1885172M1	145-7	154	1893713M91	939-12	422	1897990M91	870-3	430	21826314	75-121	84,90
1885173M1	145-8	154	189391M92	278-4	261,262	190177M1	317-1	265,280	21826316	17-9	23,30
1885317M92	340-1	283	189397M2	258-4	249,250	190560M1	503-1	346-348	21826321	17-15	23,26
1885318M93	340-4	283	1894207M91	165-28	170	190799M1	601-1	375	21826356	75-105	82,89
1885405M91	406-1	300	189427M92	615-1	375	190799R1	601-1	375	21826360	74-90	84
1885476M91	831-1	429	1894395M91	939-8	422	190848M1	602-1	375	21826362	74-32	85,86
1885489M92	130-1	132,138	189439M1	262-2	252,253	190915M91	2930-51	172	21826363	74-11	83,84,88-90
1885573M92	488-2	331,488	1894550M91	940-9	421	191141M2	385-1	299	21826370	75-105	82,89
1885710M91	585-2	371	1894961M1	143-2	142,151,153	191142M1	454-1	322	21826397	75-105	82,89
1885714M91	580-1	338,339	1894992M1	6403-52	354	191250M1	353-1	286,287	21826401	75-109	83,90
1885715M91	580-2	338,339	1895229M91	932-3	423	191495M1	454-2	322	22020X	322-4	291,292
1885776M1	851-4	438	1895271M91	920-80	399	191521M2	450-3	322	22246X	353-22	287

Les références des pièces sont indicatives.
Nos pièces ne sont pas d'origine

Part numbers are quoted for reference purposes only.
Our parts and accessories are not original.



"THE RELIABLE SERVICE"



REFERENCES INTERCHANGEABLES
CROSS REFERENCES

OEM OEM	Réf. Ref.	Page Page	OEM OEM	Réf. Ref.	Page Page	OEM OEM	Réf. Ref.	Page Page	OEM OEM	Réf. Ref.	Page Page
22255	910-1	399,406,410	2415361	11-3	22,24,26,27,29	2558375	89-1	112,113	26344	930-10	411-414,416,420
22259	910-1	399,406,410	2415390	13-3	20-24,26-29	2576675	94-4	112,113	26345	930-11	411-420
225300090	462-53	323	2415391	13-3	20-24,26-29	26071	930-3	411	26358	930-11	411-420
225600030	463-53	323	2415503	124-1	105	2612289	144-3	141,142,151-153	26358	930-5	411-420
2260211K91	920-81	400	2415574	11-10	20,21,28,29	2612417	144-29	141-144,152	26358	930-80	411-417,419,420
2260381M1	1918-56	212	24157	920-10	401,402,406-408	2612418	144-3	141,142,151-153	26365	930-10	411-414,416,420
2260382M1	1918-57	212	24157	920-4	401-410	2612419	144-100	141,143	26365	930-4	411-414,416,420
2260383M1	1912-11	214	24157	920-11	401,402,410	2612423	144-4	141,142,143,150	26365	930-87	411-414,416,420
2260384M1	1912-10	214	24157	920-108	401-405,407,408	2612424	144-128	141,143,150-153	26365	930-90	411-414,416,420
226100090	479-48	329	24157	920-92	920-92	2612431	144-22	143,144,151,153	26366	930-11	411-420
22663X	462-3	323,334	2415813	306-2	255-260,276	2612441	144-13	145,147	26398	930-16	415
22703	910-1	399,406,410	2415B201	47-67	71,74,75,76	2612443	144-102	147	26410	930-11	411-420
227291	912-1	410	2415H492	147-18	146,149,152	2612465	144-21	141-145,151-153	26410	930-5	411-420
227305	913-1	410	2418F432	124-2	105	2612468	144-22	143,144,151,153	26410	930-80	411-417,419,420
22733	910-1	399,406,410	2418F436	11-11	22-30	2612470	144-4	141,142,143,150	26410	930-80	411-417,419,420
227541	913-2	410	2418F475	13-4	20-30	2612477	144-101	146,147	26410009	101-4	117,120
227543	912-2	410	2418M001	131-6S	135	2612478	144-13	145,147	26410014	101-4	117,120
22780	910-1	399,406,410	2418M004	131-6S	135	2612480	144-102	147	26410041	101-3	117,120
22791	910-1	399,406,410	2418M505	47-65	72,73,75,76	2612481	144-36	147-149	26410042	101-3	117,120
228005741	200-1L	218,219,230	2418M506	47-63	72,73,75,76	2612485	144-103	148	26410043	101-3	117,120
229362	912-2	410	2418M507	47-64	72,75,76	2612872	144-22	143,144,151,153	26410044	101-5	117,118,120
230654M91	168-4	193	2418M508	47-66	70	26133	930-3	411	26410045	101-5	117,118,120
23617	920-4	401-410	24204	920-50	400,401,403,404	2614550	144-4	141,142,143,150	26410050	101-7	117,118,120
23622	920-4	401-410	242491307	162-25	185	2614552	144-128	141,143,150-153	26410056	101-4	117,120
23737	920-4	401-410	2461104	55-2	155-157,160-164	2614668	144-13	145,147	26410063	101-5	117,118,120
23738	920-5	406,407	24850017	151-3	155,164	2614670	144-36	147-149	26410087	101-10	117,118,120
23760	920-5	406,407	24850020	151-3	155,164	2614A149	144-205	151	26410089	101-43M	119
23765	920-4	401-410	2485605	143-18	141,142,144-153	2614A171	144-231	147	26410090	101-3	117,120
23766	920-4	401-410	2485613	143-18	141,142,144-153	2614B042	144-29	141-144,152	26410096	101-10	117,118,120
23808	920-4	401-410	2485635	143-3	141-147,150-153	2614B043	144-3	141,142,151-153	26411	930-10	411-414,416,420
23809	920-5	406,407	2485639	143-4	142,147-153	2614B050	144-212	141,142,145,152	26411	930-4	411-414,416,420
23810	920-5	406,407	2485644	143-5	142-144,150-153	2614B052	144-128	141,143,150-153	26411	930-87	411-414,416,420
23811	920-4	401-410	2485645	143-3	141-147,150-153	2614B059	144-22	143,144,151,153	26411	930-90	411-414,416,420
23835	920-17	399,400,401,403	2485648	143-3	141-147,150-153	2614B068	144-13	145,147	26412	930-10	411-414,416,420
23835	920-82	400,401	2485650	143-4	142,147-153	2614B142	144-29	141-144,152	26412	930-4	411-414,416,420
23835	920-50	400,401,403,404	2485653	143-3	141-147,150-153	2614B143	144-206	141,143	26412	930-87	411-414,416,420
23835	920-92	400,401,403,404	2485657	143-5	142-144,150-153	2614B145	144-100	141,143	26412505	101-31	118,120
23865	920-1	399,400,403,410	2485659	143-5	142-144,150-153	2614B150	144-4	141,142,143,150	26413	930-11	411-420
23880	920-1	399,400,403,410	2485666	143-3	141-147,150-153	2614B152	144-128	141,143,150-153	26413	930-5	411-420
24022	920-1	399,400,403,410	2485668	143-4	142,147-153	2614B154	144-21	141-145,151-153	26413	930-80	411-417,419,420
24033	920-17	399,400,401,403	2485C025	143-55	145-149,151-153	2614B166	144-101	146,147	2641304	100-17	117
24033	920-82	400,401	2485C034	143-60	149	2614B168	144-13	145,147	2641305	100-17	117
24033	920-50	400,401,403,404	24870010	151-1	155	2614B169	144-102	147	2641309	100-4	117,120
24033	920-92	400,401,403,404	2487004	88-1	107	2614B170	144-36	147-149	2641310	100-4	117,120
24049	920-10	401,402,406-408	2487841	85-2	106	2614B173	144-103	148	2641311	100-4	117,120
24065	920-4	401-410	2487845	85-3	106	2614B632	144-232	142	2641314	100-17	117
24066	920-5	406,407	2487854	85-2	106	2614B642	144-29	141-144,152	2641317	100-4	117,120
24087	920-80	399	2487863	85-12	106	2614B644	144-233	144	2641328	100-6	117,118,120
24087	920-17	399,400,401,403	2487983	85-13	106	2614B647	144-230	141,152	2641333	100-6	117,118,120
24087	920-1	399,400,403,410	25015M91	625-4	176,177,179,180	2614B650	144-229	143,150,151,153	2641336	100-6	117,118,120
24087	920-81	400	25038	930-1	411	2614B652	144-128	141,143,150-153	2641338	100-7	117,118,120
24087	920-82	400,401	2511425	6052-1	78-81	2614B653	144-234	144	2641345	100-5	117,119,120
24087	920-50	400,401,403,404	2511437	84-11	99,108,110,111	2614B654	144-298	147	2641346	100-5	117,119,120
24087	920-92	400,401,403,404	2511447	123-1	105	2614B655	144-273	150	2641372	100-9	118,120
241191390	144-295	145	2511613	84-9	98,100	2614B656	144-204	147,150	2641374	100-9	118,120
241191490/1	144-214	142	2511636	6093-1	105	2614B659	144-22	143,144,151,153	2641377	100-9	118,120
24123	920-17	399,400,401,403	2511A735	84-7	94,102	2614B667	144-236	147	2641378	100-9	118,120
24123	920-1	399,400,403,410	2521A414	6441-2	361	2614B668	144-235	147	26414	930-11	411-420
24123	920-81	400	2523075	920-17	399,400,401,403	26154	930-10	411-414,416,420	26414	930-5	411-420
24123	920-82	400,401	2523075	920-1	399,400,403,410	26154	930-4	411-414,416,420	26414	930-80	411-417,419,420
24123	920-50	400,401,403,404	2523075	920-50	400,401,403,404	26154	930-87	411-414,416,420	2641406	100-3	117,119,120
24123	920-92	400,401,403,404	2523075	920-92	400,401,403,404	26154	930-90	411-414,416,420	2641408	100-3	117,119,120
24124	920-17	399,400,401,403	2528201K1	692-19	386	26200	930-4	411-414,416,420	2641462	100-7	117,118,120
24124	920-82	400,401	2528202K1	692-20	386	26219	930-5	411-420	2641465	100-7	117,118,120
24124	920-50	400,401,403,404	2528203K1	692-17	386	26220	930-10	411-414,416,420	2641478	100-7	117,118,120
24124	920-4	401-410	2528204K1	692-18	386	26220	930-4	411-414,416,420	2641491	101-43M	119
24124	920-92	400,401,403,404	2541130	920-50	400,401,403,404	26220	930-87	411-414,416,420	2641701	100-72	118
2413	154-1	155,166	2541131	920-50	400,401,403,404	26220	930-90	411-414,416,420	2641704	100-71	117,120
2414111	11-1	20,21,28,29	2541290	920-108	401-405,407,408	26264	930-10	411-414,416,420	2641709	100-10	117,118,120
2414324	11-2	22,24,26,27,29	2541290	920-74	403-405	26264	930-4	411-414,416,420	2641710	100-72	118
2414325	11-2	22,24,26,27,29	2541712	920-108	401-405,407,408	26264	930-87	411-414,416,420	2641711	100-8	117,118,120
2415209	131-2B	135	2541712	920-74	403-405	26264	930-90	411-414,416,420	2641712	100-19	117,120
2415216	131-2B	135	2541713	920-50	400,401,403,404	26271	930-11	411-420	2641713	100-10	117,118,120
2415258	47-60	70,71,75	2541714	920-132	404,405	26271	930-5	411-420	2641715	100-72	118
2415335	124-2	105	2541714	920-156	404,405	26271	930-80	411-417,419,420	2641719	100-25	118,120
2415336	124-1	105	2551A009	89-5	114,115	26273	930-10	411-414,416,420	2641720	100-25	118,120
2415341	11-10	20,21,28,29	2551A014	89-6	114,115	26274	930-11	411-420	2641722	100-71	117,120
2415342	11-10	20,21,28,29	2557176	89-4	112,113	26278	930-3	411	2641725	100-10	117,118,120
2415343	11-10	20,21,28,29	2557180	89-3	112,113	26295	930-11	411-420	2641728	100-10	117,118,120
2415344	11-10	20,21,28,29	2557181	89-4	112,113	26295					

REFERENCES INTERCHANGEABLES
CROSS REFERENCES

OEM OEM	Réf. Ref.	Page Page	OEM OEM	Réf. Ref.	Page Page	OEM OEM	Réf. Ref.	Page Page	OEM OEM	Réf. Ref.	Page Page
2641A053	100-8	117,118,120	26540110	96-14	186,187	27432	930-4	411-414,416,420	2871A105	920-69	406,407
2641A054	100-71	117,120	26540132	96-2	173-175,182	27432	930-87	411-414,416,420	2871A105	920-24	406-408
2641A056	100-72	118	26540151	96-14	186,187	27432	930-90	411-414,416,420	2871A106	920-5	406,407
2641A057	100-32	118,120	26540153	96-14	186,187	27433	930-11	411-420	2871A108	920-5	406,407
2641A059	100-17	117	26540154	96-15	186	27433	930-5	411-420	2871A108	920-69	406,407
2641A063	100-4	117,120	26540218	96-1	173	27433	930-80	411-417,419,420	2871A108	920-24	406-408
2641A064	100-9	118,120	2654024	95-1	192	2746135M2	351-1	285	2871A108	920-101	407
2641A065	100-5	117,119,120	2654026	95-1	192	2746322M1	348-2	285	2871A109	920-10	401,402,406-408
2641A067	100-32	118,120	2654063	96-2	173-175,182	27470	930-10	411-414,416,420	2871A109	920-108	401-405,407,408
2641A070	100-25	118,120	2654094	97-3	177-180,185-187	27470	930-4	411-414,416,420	2871A117	920-5	406,407
2641A071	100-10	117,118,120	2654104	96-2	173-175,182	27470	930-87	411-414,416,420	2871A118	920-10	401,402,406-408
2641A073	100-8	117,118,120	2654111	96-14	186,187	27470	930-90	411-414,416,420	2871A118	920-4	401-410
2641B559	144-34	143,144	2654132	96-2	173-175,182	27515	930-11	411-420	2871A118	920-11	401,402,410
2645A603	117-43	127,128	2654153	97-2	175-188	27518	930-38	416-418	2871A118	920-108	401-405,407,408
2645A604	117-42	126,127	2654154	96-3	173-177,182-187	27520	930-38	416-418	2871A118	920-5	406,407
2645A606	117-167	128	2654156	95-1	192	27533	930-16	415	2871A118	920-69	406,407
2645A608	117-135	126-128	2654162	97-3	177-180,185-187	27539	930-11	411-420	2871A118	920-24	406-408
2645A613	117-155	126	2654167	97-3	177-180,185-187	27539	930-5	411-420	2871A119	920-5	406,407
2645A614	117-150	127	2654172	97-3	177-180,185-187	27539	930-80	411-417,419,420	2871A120	920-10	401,402,406-408
2645A615	117-168	128	2654186	97-1	174-177,182-188	27540	930-10	411-414,416,420	2871A120	920-4	401-410
2645A616	117-156	127	2654343	97-2	175-188	27540	930-4	411-414,416,420	2871A120	920-5	406,407
2645A617	117-158	127	2654347	97-3	177-180,185-187	27540	930-87	411-414,416,420	2871A120	920-69	406,407
2645A621	117-136	126	2654348	97-3	177-180,185-187	27540	930-90	411-414,416,420	2871A120	920-24	406-408
2645A627	117-154	126,127	2654400	97-3	177-180,185-187	27570	930-38	416-418	2871A121	920-5	406,407
2645A628	117-151	126-128	2654401	97-3	177-180,185-187	27571	930-10	411-414,416,420	2871A121	920-69	406,407
2645A629	117-157	127	2654403	97-2	175-188	27571	930-4	411-414,416,420	2871A121	920-24	406-408
2645A630	117-148	127	2654404	97-3	177-180,185-187	27571	930-87	411-414,416,420	2871A121	920-101	407
2645A633	117-161	126	2654406	97-1	174-177,182-188	27571	930-90	411-414,416,420	2871A122	920-10	401,402,406-408
2645A635	117-162	126,128	2654407	97-3	177-180,185-187	2757182	170-1	196	2871A122	920-108	401-405,407,408
2645A636	117-164	127	2654407	97-3	177-180,185-187	27572	930-11	411-420	2871A129	920-5	406,407
2645A637	117-149	126	2654408	97-1	174-177,182-188	27572	930-5	411-420	2871A131	920-4	401-410
2645C612	117-39	127,128	26560017	111-3	130,173-188	27572	930-80	411-417,419,420	2871A133	920-5	406,407
2645C620	117-35	126,128	26560017	111-5	130,173-188	2757272M92	244-1	269	2871A134	920-10	401,402,406-408
2645K602	117-37	126,128	26560075	112-1	130	2757279M91	199-3	217	2871A134	920-4	401-410
2645K603	117-36	126,128	26560077	96-3	173-177,182-187	2757328M1	317-7	269	2871A134	920-5	406,407
2645K608	117-163	126	26560090	96-3	173-177,182-187	27582D	930-10	411-414,416,420	2871A134	920-69	406,407
2645K609	117-146	126,128	26560110	111-3	130,173-188	27582D	930-4	411-414,416,420	2871A134	920-24	406-408
2645L604	117-35	126,128	26560110	111-5	130,173-188	27582D	930-87	411-414,416,420	2871A135	920-5	406,407
2645L605	117-153	127	26560111	112-2	130	27582D	930-90	411-414,416,420	2871A137	920-69	406,407
2645L612	117-152	127	26560602	111-6	176-181,186-188	27583	930-11	411-420	2871A137	920-24	406-408
2645L616	117-147	127	26560607	111-4	176-181,186-188	27583	930-5	411-420	2871A137	920-101	407
26460257	117-3	126,128	26560608	111-63	178-180,185,186	27583	930-80	411-417,419,420	2871A139	920-11	401,402,410
2646128	950-2	203	26561117	111-3	130,173-188	2758314	58-7	200	2871A141	920-10	401,402,406-408
26461301	117-35	126,128	26561117	111-5	130,173-188	2758346	58-2	200	2871A141	920-4	401-410
26461307	117-36	126,128	26561118	111-63	178-180,185,186	2758347	58-2	200	2871A141	920-11	401,402,410
2646607	117-3	126,128	26566611	111-3	130,173-188	2758348	58-2	200	2871A141	920-108	401-405,407,408
2646673	117-4	126,128	26566611	111-5	130,173-188	2846121	950-2	203	2871A141	920-5	406,407
2646676	117-4	126,128	26566613	111-3	130,173-188	2846122	950-2	203	2871A141	920-69	406,407
2646677	117-9	126,128	26566613	111-5	130,173-188	2846124	950-1	203	2871A141	920-24	406-408
2646678	117-8	126,128	26566615	110-301	130	2846127	950-2	203	2871A142	920-5	406,407
2646679	117-38	128	26566621	111-3	130,173-188	2846129	950-2	203	2871D031	920-69	406,407
2646681	117-32	126,128	26566621	111-5	130,173-188	2846130	950-2	203	2871D031	920-24	406-408
2646685	117-6	126,128	26566602	111-4	176-181,186-188	2848062	186-17	208	2871D031	920-101	407
2646688	117-96	126	2656804	110-302	130	2848201	940-36	421	2872365	919-5	410
2646689	117-6	126,128	2656811	110-302	130	2848201	940-4	421	2872621	919-1	410
2646690	117-8	126,128	26569051	111-63	178-180,185,186	2848203	940-36	421	2872625	919-4	410
2646695	117-9	126,128	2666103	60-2	116	2848203	940-4	421	2872631	919-4	410
2646724	117-31	126	2666106	60-3	116	2871170	910-1	399,406,410	2872635	919-5	410
2646824	117-32	126,128	2666108	60-3	116	2871182	910-1	399,406,410	2872637	919-2	410
2646825	117-35	126,128	2666805	60-1	116	2871609	920-4	401-410	2873001	930-38	416-418
2646826	117-10	126,128	2666805	60-22	116	2871610	920-5	406,407	2873006	930-11	411-420
2646831	117-62	128	2700058M91	2935-70	172	2871612	920-5	406,407	2873006	930-5	411-420
2646842	117-9	126,128	2700273M1	264-1	245-251,265,266	2871619	920-10	401,402,406-408	28730201	933-2	423
2646844	117-39	127,128	2700274M2	264-2	245-249	2871619	920-4	401-410	28733006	930-11	411-420
2646845	117-41	127,128	2700374M1	273-2	254	2871619	920-5	406,407	28733006	930-5	411-420
2646848	117-34	126,128	2707829M2	441-33	314,319,320	2871619	920-69	406,407	28733006	930-80	411-417,419,420
26510105	161-38	186,187	2708734M91	168-7	193	2871619	920-24	406-408	2873A102	930-38	416-418
26510148	161-38	186,187	2714073M1	6443-2	361	2871620	920-5	406,407	2873A104	930-90	411-414,416,420
26510211	161-38	186,187	2714076M1	355-12	361	2871621	920-4	401-410	2873B055	930-11	411-420
26510228	162-25	177,178,180-187	2714087M1	6412-3	357	2871622	920-5	406,407	2873B055	930-5	411-420
26510229	161-60	177,185,187	2714101M1	6410-2	297,360	2871623	920-24	406-408	2873B055	930-80	411-417,419,420
26510232	161-1	174	2714105M1	6408-31	360	2871624	920-5	406,407	2873B056	930-38	416-418
26510233	162-1	174	2714631M4	440-40	319,320	2871624	920-69	406,407	2873B071	930-38	416-418
26510234	162-25	177,178,180-187	2714633M4	440-39	319,320	2871624	920-24	406-408	2873B072	930-80	411-417,419,420
26510235	161-41	187	271735	933-2	423	2871624	920-101	407	2873D001	930-11	411-420
26510236	161-3	175,188	272394	932-3	423	2871625	920-5	406,407	2873D002	930-11	411-420
26510237	162-3	175,188	273738M91	2930-76	172	2871A101	920-5	406,407	2873D002	930-5	411-420
26540017	111-3	130,173-188	273743M91	162-41	186	2871A102	920-4	401-410	2873D002	930-80	411-417,419,420
26540017	111-5	130,173-188	27409	930-4	411-414,416,420	2871A104	920-5	406,407	2873D004	930-10	411-414,416,420
26540021	96-15	186	27411	930-5	411-420	2871A105	920-10	401,402,406-408	2874126	161-86	186
26540055	96-3	173-177,182-187	27413	930-3	411	2871A105	920-4	401-410	292124	939-5	422
26540077	96-3	173-177,182-									

REFERENCES INTERCHANGEABLES
CROSS REFERENCES

OEM OEM	Réf. Ref.	Page Page	OEM OEM	Réf. Ref.	Page Page	OEM OEM	Réf. Ref.	Page Page	OEM OEM	Réf. Ref.	Page Page
294394200/1	920-30	408	3040378M1	4170-18	436,437	31137321	5-3	19	31358348	36-18	49,50,54,57
294394200/1	920-71	408	3040425M1	4058-1	451	31137322	5-4	19	31358349	36-14	45,47,49,54,57
294394600/1	920-30	408	3040882M92	154-69	157,158,166	31137551	4-3	19	31358352	35-15	46,49,50,52,57
294394600/1	920-71	408	3040949M1	144-37	147-149	31137561	5-3	19	31358356	36-24	43,57
3000287X1	372-28	296,298	3040950M1	144-37	147-149	31141408	59-1	399,406	31358357	36-7C	55
3000440X1	6423-1	365	3041367M1	6678-17	387	31141425	59-1	399,406	31358361	36-14	45,47,49,54,57
3000570X91	462-51	323	3041489M4	105-7	122	31146952	131-8C	135	31358381	36-7	43,44,51,53,55,57
3000607X1	6444-1	366	3041515M94	165-148	171	31161148	15-16	35,36	31358382	36-7	43,44,51,53,55,57
3000781X1	266-1	252,253,261-68	3042085M2	1912-152	215	31162121	15-14	35,38,39	31358384	36-7A	55
3001744X1	266-1	252,253,261-68	3042086M2	1912-153	215	31162126	15-7	35-37	31358393	36-14	45,47,49,54,57
3001884X1	352-17	362	3042143M91	1920-8	215	31163411	12-10	20,28	31358394	35-14	45,47,49,52,57
3002706X1	1955-245	212-215	3042317M4	6678-17	387	31163491	12-10	20,28	31358441	35-14	45,47,49,52,57
3003369X1	372-55	295,296	3042332M91	4059-1	452	31163492	12-10	20,28	31358506	35-20	49,57
3003372X1	277-3	262,268	3042334M1	4059-1	452	31163493	12-10	20,28	31358518	36-21	46,52,57
3005557X1	6423-2	365	3042339M2	4070-2	449-452	31163494	12-10	20,28	31358521	36-21	46,52,57
3008252X1	266-1	252,253,261-68	3042960M2	303-92	278	31163495	12-10	20,28	31358522	35-21	46,52,57
3008775X91	372-58	296	3042961M1	303-93	278	31164362	82-1	94,102	31358533	36-21	46,52,57
3009106X91	354-27	287	3045111M91	144-37	147-149	31164581	94-6	112,113	31358534	35-21	46,52,57
3009131X1	6451-21	358	3045418M1	687-7	385	31164582	94-6	112,113	3135P001	36-177	43,57
3009388X1	252-1	243,265	3045477M1	417-43	305	31165115	94-3	112,113	3135X031	36-22	45,49,50,52,53,57
3009744X1	6452-14	358	30478V1	831-1	429	31165121	94-2	112,113	3135X032	35-22	45,49,50,52,57
3009747X1	443-12	318	30480	159-6	191	31165392	12-16	23,26	3135X033	36-23	46,49,52,53,57
3009748X1	441-39	320	3049010M91	144-219	150,151	31165461	94-3	112,113	3135X034	35-23	46,49,52,57
3009853X1	352-15	288,360	3052205M1	153-69	157,158	31165531	94-2	112,113	3135X041	36-108	46,48,50,52,54,57
3009884X1	6489-9	353	3052209M1	144-13	145,147	3116K111	81-1	94,102	3135X042	35-108	46,48,50,52,57
3010058X91	479-47	328	3052261M1	1987-11	435	3116W001	94-11	114,115	3135X062	35-173	46,48,50,52,57
3010156X1	2940-090	154	3052593M2	357-9	289	31170	910-1	399,406,410	3135X063	36-173	46,48,50,52,54,57
3010158X1	2940-100	154	3052598M1	4057-1	449-452	31171138	81-10	95,98,100-104	31372535	34-78	45,47,49,50,54,58
3010159X1	2940-120	154	3052600M91	4054-2	451	31171211	12-4	24,27	31411125	6051-2	78,80,81
3010161X1	2940-140	154	3052607M1	4000-21	449-452	31171272	93-1	112,113	31411142	6051-1	78,81
3010162X1	2940-160	154	3052724M1	4048-2	449,450,452	31171275	93-1	112,113	31415261	80-1	94,102
3010428X1	6489-14	353	3052974M2	581-26	336,340	31171276	93-1	112,113	31415263	80-6	94,102
3010457X1	6489-13	353	3072893M1	161-60	177,185,187	31171351	81-3	95,96,98,100-104	31415264	80-6	94,102
3010538X91	352-18	287	30854	57-1	200	31171353	81-3	95,96,98,100-104	31415292	80-3	100
3010672X91	372-48	294	309807F	913-2	410	31171461	91-3	108,110,111	31415293	80-4	95,96,100,103,104
3010685X91	372-47	294	3100765M1	1913-152	215	31171681	12-3	22,23,26,28-30	31415321	80-4	95,96,100,103,104
3010714X91	352-18	287	3100766M1	1913-153	215	31171682	12-12	24,27	31415361	80-12	97,102,104
3010720X91	354-31	287	3103957M1	872-51	430	31171683	12-11	22,23	31415363	80-12	97,102,104
3010726X91	352-20	287	3103958M1	870-74	430	31173423	120-2	105	31415371	80-7	95,96,98,102-104
3010735X91	354-30	287	3104945M1	495-36	336,340	3117C061	12-15	25,28,30	31415374	80-7	95,96,98,102-104
3010912X91	372-49	294	3104952M2	853-9	438	3117C062	12-18	23	31415382	80-13	96,100,102,103
3011321X91	354-29	287	3104953M2	853-8	438	3117F081	81-13	94	31415384	80-13	96,100,102,103
3015184X1	376-24	296	3104954M1	851-5	438	3117L012	81-14	95-104	31416305	80-11	99
3015247X1	376-28	298	3104955M1	851-6	438	3117L023	81-12	95-104	31416307	80-11	99
3015405X1	352-22	288	3105049M1	1913-114	215	3117V003	93-10	114,115	31419(M)	55-2	107, 155-164
3019564X1	2940-022	154	3105050M1	1913-114	215	31312436	1-1	11, 18	31422	55-2	107, 155-164
3019924X1	6409-6	357	3105232M93	221-95L	224	31312532	1-1	11, 18	3142A051	43-26	63,64,66,67,69,77
3019925X1	6489-11	353	3105233M92	212-58L	224	31312539	1-1	11, 18	3142A052	43-9	62,64,66,67,69,77
3019927X1	6341-1	363	3105364M92	221-96L	229	31312701	1-5	11,18	3142A053	43-9A	77
3019932X1	353-14	296,298,362	3105505M1	1919-66	213	31312712	1-5	11,18	3142A054	43-9B	77
3019953X1	371-41	295,298	3105506M1	1919-65	213	31315142	1-2	12,18	3142A055	43-9C	77
3019954X1	371-42	295,298	3106506M1	720-6	390	31315148	1-2	12,18	3142A081	43-5	61,62,68,77
3019955X1	6411-1	357	3107407M91	212-57	229	31315168	1-2	12,18	3142A091	43-60	61,77
3019956X1	6411-1	357	3107407M91	212-57L	229	31315174	1-2	12,18	3142D031	43-62	63,64,67,69,77
3019957X1	6407-2	357	3107671M1	761-1	395	31315184	1-34	12,18	3142D041	42-62	63,64,67,69,77
3019959X1	6408-2	297,359	3107673M1	602-2	376-378	31315661	1-8	13,17,18	3142D051	43-61	63,64,77
3019960X1	6408-3	297,359	3107722M1	686-10	385	31315872	1-8	13,17,18	3142D061	43-63	63,67,69
3019967X1	355-1	362	3107723M1	686-11	385	31315873	1-8	13,17,18	3142H002	42-25	62,66,67,69,77
3019968X1	355-8	362	3112E005	28-40	36	31315881	1-4	12,17	3142H041	42-63	63,67,69,77
3019969X1	356-1	362	3112E011	28-41	34,36,39,40	31315911	1-4	12,17	3142H042	42-60	61,77
3019970X1	356-2	362	31134121	84-10	98,100	31315981	1-7	12-14,17,18	3142L051	42-38	63,64,67,69,77
30217	96-3	173-177,182-187	31134123	28-2	33-36,38-40	31315985	1-7	12-14,17,18	3142L071	42-71	64,65
30241	96-2	173-175,182	31134126	28-3	33	31315993	1-4	12,17	3142L072	42-39	63,64,67,69,77
30242	111-8	187	31134129	122-1	105	31355226	33-77	47,50,54,56	3142L081	42-61	63
30262	96-2	173-175,182	31134131	28-16	33-36,38-40	31358116	35-16	44,57	3142U031	54-3	78,79,80,81
30267	96-3	173-177,182-187	31134132	56-1	95-100,102-104	31358306	36-18	49,50,54,57	3142W003	46-13	70
3027757M1	354-1	286,287,361	31134146	28-3	33	31358308	35-4	43,44,51,57	3142W004	46-14	72,73,75,76
3027758M1	354-1	286,287,361	31134151	28-1	32,33,39,40	31358314	36-24	43,57	31431011	43-5	61,62,68,77
3031206M1	277-3	262,268	31134164	56-1	95-104	31358322	35-7	43,44,51,57	31431031	43-24	61,62,68,77
3033119M92	650-4	379	31134165	56-1	95-104	31358323	36-7	43,44,51,57	31431103	42-6	62,66,67,69,77
3033193M91	560-29	379	31137171	5-1	19	31358323A	36-7A	55	31431104	43-9	62,64,66,67,69,77
3033243M3	495-167	336,340	31137172	5-2	19	31358323C	36-7C	55	31431105	43-9	62,64,66,67,69,77
3033244M2	497-26	336,339	31137191	4-1	19	31358323E	36-7E	55	31431109	43-9	62,64,66,67,69,77
3033258M1	581-26	336,340	31137192	4-2	19	31358323K	36-7K	55	31431121	42-26	61,68,77
3033689M1	486-51	353	31137201	5-1	19	31358324	36-18	49,50,54,57	31431142	43-16	63,66,69,77
3033849M1	6296-1	267,268	31137202	5-2	19	31358339	36-14	45,47,49,54,57	31431154	42-16	63,66,69,77
3033888M1	6678-17	387	31137211	4-1	19	31358341	35-14	45,47,49,52,57	31431261	42-3	61,62,68,69,77
3036278M1	144-216	150,151	31137212	4-2	19	31358343	36-13	46,49,50,57	31431271	43-4	61,68,69,77
3038730M2	600-4	374	31137221	5-1	19	31358344	36-13	46,49,50,57	31431281	42-4	61,62,68,69,77
3038732M2	600-5	374	31137222	5-2	19	31358345	35-7	43,44,51,57	31431311	42-9	62,64,66,67,69,77
3038899M1	144-34	143,144	31137311	4-3	19	31358346	36-15	46,49,50,52,53,57	31431312	42-9A	77
3039521M91	177-12	201	31137312	4-4	19	31358347	36-7	43,44,51,53,55,57	31431313	42-9B	77

REFERENCES INTERCHANGEABLES
CROSS REFERENCES

OEM OEM	Réf. Ref.	Page Page	OEM OEM	Réf. Ref.	Page Page	OEM OEM	Réf. Ref.	Page Page	OEM OEM	Réf. Ref.	Page Page
31431314	42-9C	77	32455123	94-5	112,113	3302471M91	176-26	199	3308296M2	423-13	302
31431315	42-9	62,64,66,67,69,77	32527	96-2	173-175,182	3302472M91	177-11	201	3308481M99	150-117	161-163
31431316	42-9A	77	32550	143-3	141-147,150-153	3302477M92	200-253L	229	3308583M1	154-244	160,167
31431317	42-9B	77	32589	100-5	117,119,120	3302501M92	566-222	368	3308585M1	154-242	160,161,167
31431318	42-9C	77	32591	96-2	173-175,182	330255X1	463-2	323,334	3308686M1	358-8	289
31431322	42-6A	77	32599	96-14	186,187	330256X1	463-2	323,334	3308792M91	417-30	302
31431323	42-6B	77	327000246	221-1L	218,219,221,230	3302605M91	413-22	313	3308908M91	177-45	201
31431324	42-6C	77	32718522	83-2	98,100	3302607M1	4073-5	448	3309227M91	1912-145	213
31431332	43-9A	77	32731127	93-2	112,113	3302666M92	4200-30	192	3310087M1	104-3	122
31431333	43-9B	77	32762116	26-2	33-36,38-40	3302699M91	420-28	301	331015710	221-68	223,226,227,231
31431334	43-9C	77	32762144	26-2	33-36,38-40	3302705M5	4047-7	448	3310292M91	1919-39	212
31431401	42-6A	77	32762145	26-2	33-36,38-40	3302706M4	4047-7	448	3310293M91	1919-40	212,213
31431402	42-6B	77	3300000M99	200-403L	224	3302770M1	758-20	398	3310307M91	1913-112	215
31431403	42-6C	77	3300001M94	200-402L	224	3302795M91	1987-12	435	3310317M91	566-5	368
31431411	43-9A	77	3300019M91	105-20	122	3302840M1	7700-4	306	3310344M91	6403-1	354
31431412	43-9B	77	3300427M94	573-1	366	3302937M91	962-10	207	3310349M91	1913-145	213
31431413	43-9C	77	3300524M92	181-49	210	3303000M96	200-403L	224	3310351M91	411-42	313
31431511	42-5	61,62,68,77	3300530M91	953-14	203	3303001M93	200-402L	224	3310355M91	161-104	178,180,184,185
31431521	43-5	61,62,68,77	3300536M92	961-11	209	3303021M91	871-1	430	3310357M1	162-142	182-184
31431531	42-27	61,68,77	3300568M91	964-15	209	3303023M2	4072-7	448	3310358M1	161-142	182-184
31431591	43-4	61,68,69,77	3300757M92	759-34	398	3303137M95	200-255L	229	3310469M91	494-1	356
31431631	43-27	61,68,77	3300901M91	574-25	182-185	3303219M1	9604-102	91	3310490M91	6403-22	354
31431641	42-6	62,66,67,69,77	3300930M91	566-6	368	3303220M1	9604-110	91	3310761M91	221-97L	229
31431671	43-16	62,64,66,67,69,77	3300937M1	6618-3	380	3303316M1	153-236	160-163,166	3310764M1	418-7	302,305
31431681	42-5	61,62,68,77	3300945M1	372-56	296	3303415M91	510-2	349	3310765M1	419-8	302,305
31431691	43-5	61,62,68,77	3300965M1	554-2	274	3303567M1	440-44	320	3310794M92	221-411L	224
31431731	43-27	61,68,77	3301095M1	154-115	163,166	3303732M92	410-29	313	3310798M91	354-1	286,287,361
31431741	42-27	61,68,77	3301097M1	153-219	163,165	330375X1	352-12	361	3310812M1	419-9	305
31431752	43-26	63,64,66,67,69,77	3301158M94	165-70	171	330376X1	352-11	288,295,298	3310831M91	1988-3	434
31431761	43-5	61,62,68,77	3301221M2	4090-1	437	3303980M92	1912-10	214	3310930M91	6410-20	358
31431791	43-9	62,64,66,67,69,77	3301222M1	4090-2	437	3303982M92	1912-11	214	3311325M91	221-412	224
31431851	43-9	62,64,66,67,69,77	3301229M91	200-253L	229	3304168M92	150-123	163	3311325M91	221-412E	224
31431881	43-6	62,66,67,69,77	3301230M92	221-97L	229	3304174M92	150-124	163	3311325M91	221-412L	224
31431882	43-6A	77	3301234M91	212-57	229	3304220M1	440-38	314,320	3311326M93	221-412L	224
31431883	43-6B	77	3301234M91	212-57L	229	3304290M91	186-27	207	3311326M93	221-412E	224
31431884	43-6C	77	3301268M91	172-36	194	3304296M1	9604-121	91	3311326M93	221-412L	224
31431941	43-3	61,62,68,69,77	3301290M93	198-10	217	3304340M91	762-42	398	3311326M93	221-412L	224
31431951	43-26	63,64,66,67,69,77	3301295M91	640-31	368	3304415M91	905-2	373	3311380M93	221-95L	224
31431961	43-26	63,64,66,67,69,77	3301296M1	648-7	380	3304468M92	200-253L	229	3311397M91	221-411L	224
31431981	42-24	61,68,77	3301298M91	181-41	210	3304534M1	4073-5	448	3311397M91	221-411L	224
31431991	43-5	61,62,68,77	3301382M93	410-43	313	3304583M95	200-402L	224	3311406M91	176-38	199
31434161	54-3	78,79,80,81	3301397M1	153-219	163	3304584M92	221-412	224	3311538M92	221-411L	224
31434162	54-3	78,79,80,81	3301462M1	486-48	352	3304584M92	221-412E	224	3311538M92	221-411L	224
31434163	54-3	78,79,80,81	3301568M92	851-3	438	3304584M92	221-412L	224	3311571M91	1913-113	214,215
31434165	54-3	78,79,80,81	3301617M91	871-1	430	3304585M95	200-402L	224	3311649M92	411-44	313
31434307	53-2	78,79,80,81	3301628M91	172-37	194	3304586M93	221-412	224	3311651M91	414-42	313
31447	55-2	107, 155-164	3301676M92	761-51	398	3304586M93	221-412E	224	3311741M92	4200-28	192
31744127	44-4	71,72,73,74,75,76	3301681M91	762-43	398	3304586M93	221-412L	224	3311942M91	221-95L	224
31744131	44-4	71,72,73,74,75,76	3301687M91	759-51	398	3304616M91	740-36	393	3311943M91	212-58L	224
31744133	44-67	71,72,73,74,75,76	3301711M2	758-19	398	3304634M91	417-30	302	33217107	51-11	55
31745117	45-4	71,72,73,74,75,76	3301721M92	760-60	398	3304635M2	422-29	302	3313A012	41-61	63,64,67,69
31745121	45-4	71,72,73,74,75,76	3301751M92	760-62	398	3304636M1	423-13	302	3313E001	41-9	62
31745122	45-61	71,72,73,74,75,76	3301841M3	4020-8	448	3304650M1	357-5	288	3313E011	41-19	61,68
3174P002	45-17	70	3301845M4	4020-8	448	3304822M91	353-12	288,361,362	3313E734	41-19	61,68
3174P405	45-62	72,73,76	3301853M92	4170-59	437	3305061M1	556-11	274	3313E735	41-19	62
3174P409	45-63	72,73,75,76	3301854M91	4170-60	437	3305099M1	556-9	274	3314437M1	497-19	341-343
3174P412	45-64	72,75,76	3301855M91	4170-61	437	3305189M92	950-36	203	3314663M91	585-1	338,339,371
31786412	86-1	107	3301856M2	4170-62	437	3305190M91	951-2	203	3316A031	41-3	61,62,68,69
31787437	86-2	107	3301875M3	4000-20	448	3305272M91	421-8	301	33173108	46-2	71,72,73,74,75,76
31787455	86-5	107	3301879M3	4012-14	448	3305407M92	176-26	199	3318A705	41-62	63,64,67,69
31854	950-1	203	3301880M4	4012-14	448	3305408M93	174-11	196	3321750M8	303-45	278
3186170M92	580-2	370	3301889M91	1980-18	434	3305584M92	1918-89	213	3321752M99	303-94	278
3186171M92	580-1	370	3301890M91	1980-18	434	3305623M92	410-28	313	33221319	27-1	32,33,39,40
3186320M92	580-3	370	3301898M91	1987-31	435	3305625M91	181-49	210	33221321	27-2	33-36,38-40
3186321M91	580-3B	370	3301920M92	870-2	430	3305762M1	6407-44	297	33221327	27-1	32,33,39,40
3186323M91	580-3	370	3301946M93	760-61	398	3305773M1	358-6	288,289	33221328	27-2	33-36,38-40
3186482M91	413-1	311	3302034M91	950-36	203	3305774M1	376-25	298	3323536M91	4170-18	436,437
3186484M91	413-2	311	3302048M92	200-255L	229	3306228M1	305-21	279,394	3323729M1	144-296	148
3187412M91	807-3	372	3302049M93	221-96L	229	3306490M1	6407-45	297	33261723	41-3	61,62,68,69
3188958M1	6297-1	267,268	3302055M91	240-26	185	3306547M2	4072-8	448	33261725	41-19	61,68
31944	111-2	173	3302114M91	414-40	313	3306589M1	442-21	318	33261727	41-20	61,62,68,69
31990	117-3	126,128	3302117M93	760-62	398	3306612M93	958-37	202	33261731	41-17	62,63,64,66,67,69
32116	11-2	22,24,26,27,29	3302129M91	411-40	313	3307250M91	240-25	176,182-184	33261732	41-17	62,63,64,66,67,69
3215914M1	973-2	204	3302134M91	103-14	122	3307666M91	2940-060	154	33261741	41-9	62
32186142	26-13	34,36,39,40	3302143M91	231-67	229	3307667M91	2940-070	154	33261751	41-18	62,63,64,66,67,69
3224973M1	486-49	352	3302340M91	181-49	210	3307673M1	6677-6	387	33261752	41-18	62,63,64,66,67,69
32327	111-1	173,187	3302353M1(2x)	7703-5K	306	3307850M91	2940-050	154	33261754	41-18	62,63,64,66,67,69
32416105	21-50	31	3302353M1(3x)	7703-6K	306	3307942M97	150-116	160-163	33261757	41-18	62,63,64,66,67,69
32416118	21-38	31	3302354M1	7703-5K	306	3308187M99	150-114	160-163	33426161	83-1	95-100,102-104
32416119	21-50	31	3302354M1(2x)	7703-6K	306	3308251M92	176-31	199	33432532	41-8	63,66,69
32418117	22-35	31	3302355M1	7700-3	306	3308294M1	422-29	302	33435	117-31	126
32418122	22-38	31	3302442M91	872-3	430	3308295M2	422-29	302	3343F001	41-17	62,63,64,66,67,69

Les références des pièces sont indicatives.<

REFERENCES INTERCHANGEABLES
CROSS REFERENCES

OEM OEM	Réf. Ref.	Page Page	OEM OEM	Réf. Ref.	Page Page	OEM OEM	Réf. Ref.	Page Page	OEM OEM	Réf. Ref.	Page Page
3343F002	41-17	62,63,64,66,67,69	3382984M1	154-43	157,166	338618X1	2940-070	154	3405393M2	920-17	399,400,401,403
3343F031	41-17	62,63,64,66,67,69	3382985M1	154-45	158,166	3386190M91	144-37	147-149	3405393M2	920-1	399,400,403,410
3343F041	41-17	62,63,64,66,67,69	3382T004	142-9	133,140	3386209M2	975-5	209	3405418M1	111-3	130,173-188
3343J001	41-18	62,63,64,66,67,69	3383013M1	165-122	171	338620X1	2940-100	154	3405419M1	111-4	176-181,186-188
3343J002	41-18	62,63,64,66,67,69	3383014M7	166-15	172	3386214M1	144-221	147-149	3405500M7	3102-238	431
3343J021	41-18	62,63,64,66,67,69	3383044M91	144-35	144	338622X1	2940-120	154	3405503M7	3102-232	431
33451801	99-1	112,113	3383079M5	410-46	312	338623X1	2940-140	154	3405505M7	3102-214	431
33455123	94-5	112,113	3383107M91	560-30	379	338624X1	2940-160	154	3405507M3	3102-239	431
33458101	99-1	112,113	3383204M1	1919-38	212	3386405M1	477-51	326,328	3405508M7	3102-235	431
33472514	121-1	105	3383210M2	409-32	309	3386701M2	625-7	178-180	3405510M3	3102-234	431
3370427M91	1884-53	204	3383226M1	200-73	230	3386895M2	371-32	293	3405511M5	3102-242	431
3371936M91	168-4	193	3383227M1	221-73	230	3386896M92	422-7	303	3405513M3	3102-218	431
3372217M1	144-220	150,151	3383324M1	372-45	293	3386897M92	422-8	303	3405514M7	3102-223	431
33800125M1	4053-1	450,451	3383386M92	240-61	177,178	3386985M1	6418-2	364	3405515M2	3102-221	431
3380056M2	6492-1	364	3383568M1	305-24	278	3387083M91	700-24	388	3405516M6	3102-222	431
3380064M1	409-31	309	3383709M1	372-43	293,294	3387137M1	477-52	328	3405517M7	3102-208	431
3380073M1	187-26	207	3383712M1	372-46	293,294	3387281M1	347-2	285	3405543M7	3102-241	431
3380125M2	4053-1	450,451	3383714M1	372-42	293,294	3387450M91	1918-68	213	3405544M7	3102-229	431
3380127M1	4052-1	450,451	3383716M1	372-41	293	3387562M2	144-34	143,144	3405545M7	3102-244	431
3380133M1	4056-1	449-451	3383891M3	976-4	209	3387747M1	153-45	158,165	3405549M6	3102-246	431
3380135M1	4055-1	449-451	3383E001	141-12	134,140	3387822M1	486-44	353	3405574M2	3102-200	431
3380149M2	872-1	430	3384035M3	762-11	397	3387823M1	486-45	353	3405614M5	3102-245	431
3380271M1	4054-1	450	3384053M11	470-8	326	3388256M3	108-32	123	3405615M7	3102-202	431
3380337M91	1884-48	204	3384054M11	471-8	326	3388348M93	1881-6	209	3405617M7	3102-247	431
3380431M1	4200-33	192	3384087M93	760-22	397	3388402M1	1884-47	204	3405631M3	3102-240	431
3380442M1	423-23	305	3384093M1	486-52	353	3388432M2	165-123	171	3405633M5	3102-209	431
3380478M92	760-44	398	3384105M1	461-51	323,328	3388434M1	165-122	171	3405634M7	3102-211	431
3380480M99	150-115	162,163	3384152M1	4000-21	449-452	3388604M92	172-33	195	3405635M6	3102-210	431
3380481M99	150-117	161-163	3384153M1	4014-4	449-452	3388605M93	172-34	195	3405636M5	3102-221	431
3380636M1	168-7	193	3384311M91	6679-21	387	3388606M93	172-35	195	3406706M1	905-1	373
3380703M91	735-6	392	3384380M1	154-44	158,166	3388646M92	1920-7	215	3406707M1	906-1	373
3381094M1	187-1	207	3384406M1	486-55	353	3388831M4	226-9	240	3406970M91	860-1	427
33811112	9156-26	130	3384575M1	1884-52	204	3388840M2	4200-25	192	3406971M91	860-2	427
33811113	9156-27	130	3384595M2	440-45	320	3388927M1	221-75	230	3406972M91	861-4	427
33811114	9156-28	130	3384597M1	441-37	314	3389389M2	4073-6	453	3406973M91	861-6	427
33811115	9156-29	130	3384600M2	441-35	314-320	3389391M2	4012-15	453	3406974M91	867-3	427
3381122M2	200-75	230	3384601M4	440-37	314	3389393M2	4047-8	453	3406975M91	867-6	427
3381352M91	920-17	399,400,401,403	3384602M4	440-36	314	3389398M2	4027-1	453	3406976M91	867-7	427
3381352M91	920-1	399,400,403,410	3384603M1	442-19	316,318	3389399M2	4026-1	453	3406977M91	867-4	427
3381352M91	920-50	400,401,403,404	3384620M1	442-12	315,316	3389525M1	144-222	146,149	3406978M92	860-7	428
3381352M91	920-92	400,401,403,404	3384624M1	442-13	315,316	3389556M2	870-4	430	3406979M91	860-8	428
3381352M91	920-82	400,401	3384671M1	870-1	430	3389736M1	153-234	158,166	3406981M91	860-9	428
3381364M91	144-36	147-149	3384675M1	560-31	379	3389746M1	4200-34	192	3406983M92	860-10	428
3381384M2	485-5	330,331,332	3384685M3	410-7	312	3389902M3	4072-9	453	3406985M92	860-12	428
3381386M1	186-15	208	3384824M1	2935-70	172	3389964M91	1912-123	215	3406992M91	1987-9	435
3381387M5	186-14	208	3384857M2	6492-3	364	339034X1	443-7	315	34157	11-21	21
3381403M1	958-36	202	3384863M93	231-17	230	339393X1	463-37	323	34186	11-34	26
3381409M1	176-27	199	3384871M1	908-5	373	339394X1	462-37	323	34228	950-2	203
33814311	141-10	133,140	3384873M8	908-5	373	339394X1	354-8	362	3426045M1	353-7	358,361,362
3381565M1	1987-20	435	3384959M1	417-43	305	339436X1	304-19	279	3426152M1	6451-18	358
33817117	47-1	71,72,73,74,75,76	3385087M1	4073-6	453	339439X1	352-11	288,295,298	3426192M1	6407-2	357
33817125	47-1	71,72,73,74,75,76	3385203M1	4047-8	453	339440X1	352-12	361	3426220M1	486-48	352
33817402	47-2	73,74	3385240M5	4000-23	453	339481X1	354-9	362	3426255M1	497-17	341-344
33817403	47-7	71	3385254M91	1987-12	435	339482X1	6451-19	358	3426276M1	495-41	341-343
3381904M1	176-34	198	3385255M93	1980-19	434	339581X1	230-270	231	3426312M1	497-16	341-344
3381907M1	173-3	197	3385303M1	4027-1	453	339583X1	230-271	231	3426313M1	495-38	341,343
3381908M1	171-3	197	3385304M1	4026-1	453	339599X1	230-24	224,229	3426332M1	6450-8	358
3381924M3	581-26	336,340	3385310M91	4170-51	437	339818X1	6441-1	361	3426336M1	495-37	341-343
3381926M91	479-46	328	3385311M91	4170-52	437	339856X1	6441-2	361	3426523M2	6450-7	358
3381990M1	221-75	230	3385314M91	4170-53	437	3401240M91	580-1	338,339	3426619M1	6451-17	358
3382021M91	422-7	303	3385316M91	872-3	430	3401241M91	580-2	338,339	3426620M1	6452-16	358
3382072M7	303-64	278	3385322M1	4090-5	437	3401834M91	620-4	374	3426639M1	6432-2	360
3382073M7	303-62	278	3385371M1	4177-1	437	3404259M92	460-24	334	3426660M1	497-19	341-343
3382074M10	303-44	278	33854114	141-133	134,137,140	3404477M91	585-19	371	3426730M1	6431-1	360
3382280M1	565-75	369	33855114	142-16	134,140	3405150M91	185-1	210,211	3426753M1	6408-3	297,359
3382325M1	417-44	305	33855121	142-30	134,140	3405151M91	184-1	211	3426773M3	495-34	336,339,341-343
33826111	17-4	20,21,28,29	338552X1	261-2	245-251,265,267	3405153M91	1912-118	215	3426806M1	486-49	352
33826115	17-4	20,21,28,29	3385733M1	161-27	178-180	3405154M91	1912-119	215	3426809M1	6408-2	297,359
3382726M2	761-12	397	3385734M1	162-27	178-180	3405186M1	1955-472	211	3426821M1	6489-6	352
3382727M93	760-22	397	3385756M91	967-61	206	3405248M91	372-44	293	3426823M1	6452-14	358
3382728M92	759-14	397	3385758M92	967-23	206	3405249M91	353-21	287	3426844M1	353-14	296,298,362
3382759M91	296-7	232	3385760M92	967-24	206	3405259M92	460-24	334	3426845M1	355-8	362
3382760M1	221-73	230	3385801M1	1987-22	435	3405341M91	354-25	286,287	3426850M2	6410-3	297,359
3382762M1	200-73	230	3385822M1	1884-49	204	3405342M91	354-26	286,287	3426851M2	6410-4	297,359
3382795M93	150-82	158	3385987M1	422-49	305	3405346M91	372-40	293	3426852M3	6433-1	360
3382797M1	150-81	157	338612X1	2940-012	154	3405350M1	9604-103	91	3426853M3	6433-2	360
3382848M91	700-23	388	3386146M3	108-50	125	3405351M1	9604-101	91	3426870M2	6430-1	360
3382849M91	702-13	388	338614X1	2940-035	154	3405352M5	9604-102	91	3426892M1	6411-1	357
3382851M91	703-13	388	3386150M91	231-17	230	3405353M1	9604-102	91	3426924M1	356-2	362
3382853M91	701-13	388	338615X1	2940-040	154	3405356M1	9604-105	92	3426925M1	356-1	362
3382976M2	153-43	157,165	338616X1	2940-050	154	3405390M1	920-50	400,401,403,404	3426930M1	355-1	362
3382977M1	153-44	158,165	338617X1	2940-060	154	3405393M2	920-80	399	3426938M1	6462-1	297,357

Les références des pièces sont indicatives.
Nos pièces ne sont pas d'origine

Part numbers are quoted for reference purposes only.
Our parts and accessories are not original.

REFERENCES INTERCHANGEABLES
CROSS REFERENCES

OEM OEM	Réf. Ref.	Page Page	OEM OEM	Réf. Ref.	Page Page	OEM OEM	Réf. Ref.	Page Page	OEM OEM	Réf. Ref.	Page Page
3427104M91	341-24	363	3473435M1	4021-11	442	3515587M1	162-23	176,188	35354267	127-6	129
3427107M91	341-25	363	3473512M91	4170-55	436	3516195M2	144-223	151-153	35354271	127-7	129
3427113M91	341-26	363	3473639M91	920-5	406,407	3519252M92	920-115	408	35354293	127-7	129
3427161M91	341-8	363	3473651M1	1919-40	212,213	3519400M92	930-82	420	35354316	127-6	129
3427168M2	497-20	341	3473800M91	931-10	423	35211	159-4	191	35354317	127-5	129
3427186M1	6411-1	357	3473804M91	939-16	422	35212	96-15	186	35354318	127-1	129
3427330M91	6403-3	354	3473919M1	169-12	193	35218	100-6	117,118,120	35355283	127-2	129
3427346M91	6403-4	354	3473937M91	940-9	421	3522468M3	144-297	151,153	35355289	127-8	129
3427352M91	6403-5	354,365	3474587M1	940-12	421	3522485M3	144-224	151,153	35355409	127-8	129
3427406M1	6403-21	355	3474596M91	920-17	399,400,401,403	3523401M91	939-15	422	35355439	127-3	129
3427685M3	495-35	341	3474596M91	920-50	400,401,403,404	3523416M91	922-11	410	353619X1	2070-250	324
3427870M1	6462-17	357	3474596M91	920-4	401-410	35273	100-3	117,119,120	3536200M91	1912-146	214
3428064M1	6409-1	357	3474596M91	920-92	400,401,403,404	35288	96-2	173-175,182	353623X1	2070-300	324
3428067M1	6408-6	359	3475308M1	151-2	155,164	35289	96-2	173-175,182	3536264M1	920-10	401,402,406-408
3428141M3	440-43	320	3475771M91	940-6	421	35297	103-1	122	3536264M1	920-11	401,402,410
3428155M91	6403-56	354,355	3475808M1	6403-5	354,365	3530018M92	573-1	366	3536264M1	920-108	401-405,407,408
3428238M3	440-42	319	3475909M2	6427-1	365	3530025M91	964-15	209	3536264M1	920-74	403-405
3428259M1	355-10	362	3475940M1	574-1	174-177,188	3530223M92	641-26	182-185	3536264M1	920-155	404
3428268M1	497-105	341-343	3475945M91	495-58	339,340	3530230M92	172-28	194	3536264M1	920-132	404,405
3428271M2	6410-34	293,359	3475946M91	495-33	339,340	3530293M92	176-36	199	3536264M1	920-156	404,405
3428314M1	355-9	362	3475991M1	4000-17	444	3530335M91	165-145	170	3536279M92	410-44	313
3428317M1	6408-3	297,359	3475992M1	4000-18	445	3530346M1	153-241	160,161	353627X1	2070-350	324
3428434M91	6403-58	355	3475994M1	4011-4	444,445	3530396M1	153-238	162,166	3536401M91	413-40	313
3428478M1	6410-33	359	3475995M1	4010-4	444,445	3530397M1	154-249	160,161	353643X1	2070-550	324
3428503M1	6408-3	297,359	3476027M1	872-2	430	353064X1	304-18	279	353655X1	2070-700	324
3428504M1	6408-3	297,359	3476043M1	1987-20	435	3531031M1	6409-6	357	3536739M91	640-29	368
3428521M2	6409-5	357	3476047M91	1912-120	215	3531032M1	6489-11	353	3536767M1	710-10	389
3428571M1	6462-14	357	3476048M91	1912-120	215	3531100M1	6341-1	363	3537089M1	422-47	302
3428818M2	495-121	341,343	3476125M91	495-35	336,339	3531377M1	438-2	317	3537270M1	353-26	288
3428829M1	6409-4	357	3476127M1	4047-6	444,445	3531378M1	436-3	317	3537271M1	353-25	288
3428834M1	6462-13	357	3476137M1	4073-3	444,445	3531379M1	437-2	317	3537279M91	372-53	295
3428860M91	6403-53	355	3476151M1	4170-30	436	3531529M91	1918-88	213	3537810M91	410-27	313
3428942M1	355-6	362	3476157M1	4170-88	436	3531689M92	165-146	170	3537812M91	413-10	313
3428955M1	495-69	342,343	3476159M1	4022-10	444,445	3532084M93	740-44	393	3537827M1	710-10	389
3428971M1	6450-20	358	3476160M1	4022-11	445	3532132M91	712-26	391	3538541M91	920-10	401,402,406-408
3428972M1	6452-18	358	3476171M1	4170-87	436	3532192M96	200-254L	224,229	3538541M91	920-108	401-405,407,408
3429001X1	6411-1	357	3476182M1	4072-4	445	3532193M94	200-254L	224,229	3538636M91	417-41	302
3429002X1	6407-3	357	3476187M1	870-3	430	3532250M91	372-51	295,298	3538837M1	422-46	302
3429004X1	6408-2	297,359	3476244M91	920-69	406,407	3532345M91	353-24	288,289	3538838M1	423-21	302
3429037M1	6408-1	359	3476244M91	920-24	406-408	3532476M1	296-4	232	353894X1	2070-800	324
3429038M1	6417-1	359	3476244M91	920-101	407	3532501M91	200-254L	224,229	3538957M91	565-52	368
3429167M1	6408-32	359	3476251M2	871-3	430	3532565M91	181-46	210	3538958M92	565-52	368
3429168M1	6417-5	359	3477316M91	931-9	423	3533036M1	6462-46	297	3539007M91	145-5	154
3429169M1	6408-35	359	3477380M93	413-3	311	3533074M1	4114-15	439	3539008M91	145-6	154
3429173M3	495-120	341-343	3477381M93	413-4	311	3533170M91	187-24	207	3539071M92	976-3	209
3429317M1	6452-19	358	3477544M1	217-2	239	3533174M92	958-38	202	353928X1	452-1	322
3429318M1	6452-20	358	3477716M1	4072-5	444	3533205M92	740-45	393	3539390M91	930-11	411-420
3429319M1	6450-9	358	3477778M1	4022-11A	444	3533293M91	712-27	391	3539390M91	930-5	411-420
3429436M1	6403-55	355	3477851M91	920-17	399,400,401,403	35333910M91	565-48	368	3539390M91	930-80	411-417,419,420
3429558M1	6450-20	358	3477851M91	920-1	399,400,403,410	3533911M91	565-52	368	3539477M1	976-1	209
3429586M1	6450-20	358	3477851M91	920-81	400	3533922M91	967-22	205	353957X1+		
3429676M1	353-16	362	3477851M91	920-82	400,401	3534030X1+			188148M1+		
3429727M1	6403-21	355	3477851M91	920-10	401,402,406-408	188909M1+			188359M1+		
3429731M1	495-66	341,343,344	3477851M91	920-4	401-410	881727M1+			491105M1	716-5	390
3429790M2	6408-33	359	3477851M91	920-11	401,402,410	881728M1+			3539857M91	566-61	368
3429791M1	6408-2	297,359	3477851M91	920-92	400,401,403,404	881729M1+			3539858M91	566-60	368
3429815M3	6408-3	297,359	3478290M1	415-1	311,312	375108X1	579-1	370	3539859M91	640-30	368
3429864M1	6450-22	358	3478291M1	415-2	311,312	3534145M91	150-121	163	3540046M1	161-143	183-185
3429889M2	6408-34	359	3478319M2	872-2	430	35342004	127-1	129	3540047M1	162-143	183-185
3429910M1	6450-21	358	3478320M1	4000-41	444	35342005	127-2	129	3540051M1	161-153	184
3429996M1	6403-55	355	3478327M1	4200-35	192	35342006	127-3	129	3540052M1	162-153	184
3442308M91	585-9	356	3478359M91	212-6	219-223,225-228	35342023	127-1	129	3540153M91	352-14	361
3443036M91	495-32	337,339,340	3478360M91	920-10	401,402,406-408	35342024	127-2	129	3540223M91	411-43	313
3443433M93	585-5	371,372	3478360M91	920-4	401-410	35342025	127-3	129	3540224M91	411-45	313
34501	950-1	203	3478360M91	920-11	401,402,410	353427X1	443-1	315,324	3540225M91	414-41	313
3460675M1	17-5	22-30	3478360M91	920-108	401-405,407,408	35343025	127-5	129	3540401M91	585-27	372
3465095M91	920-80	399	3478477M91	4200-31	192	35343026	127-6	129	354046X1	205-1	238,239
3465754M1	4020-9	449	3478569M92	212-16	239	35343027	127-7	129	3540478M91	200-254L	224,229
3465755M1	4022-12	449	34821422	142-1	131,138,140	35343028	127-8	129	3540479M91	200-403L	224
3465962M91	449-16	321	34825133	142-31	134,140	353430X1	127-9	238,239	3540480M91	200-402L	224
3467043M91	920-17	399,400,401,403	34828462	142-3	133,140	35343136	209-5	129	354048X1	205-1	238,239
3467043M91	920-1	399,400,403,410	34828487	141-11	133,137,139,140	35343137	127-6	129	354055X1	207-1	238,239
3467043M91	920-82	400,401	3482T009	141-131	133,139,140	35343138	127-7	129	3540865M91	200-271	230
3467043M91	920-50	400,401,403,404	3484317M92	585-10	356	35343139	127-8	129	3540866M92	221-270	230
3467171M91	4200-34	192	3484327M92	494-3	356	353435X1	484-1	324	3540951M91	212-270	230
3473013M1	1987-18	435	3484582M91	585-25	372	353436X1	502-1A	346	3540970M91	566-113	368
3473254M1	530-14	350	3484624M92	585-11	356	3534387M91	565-48	368	3542186M91	930-10	411-414,416,420
3473296M91	940-14	421	3484685M91	585-21	371	3534528M1	154-248	163,167	3542186M91	930-4	411-414,416,420
3473297M91	4170-14	436	3484807M91	494-2	356	3534550M1	153-240	163,166	3542186M91	930-87	411-414,416,420
3473298M91	4170-15	436	3488643M91	585-12	356	3534941M91	565-52	368	3542186M91	930-90	411-414,416,420
3473415M1	4047-4	442,443	3505655M1	154-250	164	3535290M91	872-51	430	3542187M91	930-11	411-420
3473434M1	4021-9	443	3515586M1	161-24	176,188	35354266	127-5	129	3542187M91	930-5	411-420

Les références des pièces sont indicatives.
Nos pièces ne sont pas d'origine

Part numbers are quoted for reference purposes only.
Our parts and accessories are not original.



REFERENCES INTERCHANGEABLES
CROSS REFERENCES

OEM OEM	Réf. Ref.	Page Page	OEM OEM	Réf. Ref.	Page Page	OEM OEM	Réf. Ref.	Page Page	OEM OEM	Réf. Ref.	Page Page
3542187M91	930-80	411-417,419,420	3582179M2	153-132	158,159,165	3597692M91	565-1	368	3614715M2	144-227	145,148
354369X1	463-3	323,334	3582207M91	150-81	157	3597706M91	565-1	368	3614780M91	410-18	311
354370X1	463-3	323,334	3582541M2	761-46	398	3598406M6	166-18	172	3615017M1	108-34	123
3543737M3	303-77	279	3582662M1	758-3	394,396	3599000M2	303-17A	276	3615042M2	740-38	393
354416X1	329-1	281	3582718M1	1987-44	435	3599061M1	486-49	352	3615052M4	700-24	388
3545853M1	153-239	163,166	3582821M1	920-108	401-405,407,408	3599253M1	440-41	319	3615054M3	700-23	388
3545945M1	357-10	289	3582821M1	920-74	403-405	3599263M1	479-43	326,327,328	3615055M3	760-45	398
3546390M91	930-10	411-414,416,420	3582876M1	172-43	195	3599307M91	186-1	208	3615160M2	409-36	310
3546390M91	930-4	411-414,416,420	3582909M1	154-236	158,167	3599459M92	221-36	225-227,231	3615259M2	438-1	317
3546390M91	930-87	411-414,416,420	3582916M92	186-19	208	3599460M92	221-36	225-227,231	3615366M1	221-73	230
3546390M91	930-90	411-414,416,420	3582951M1	144-301	149	3599461M92	221-69	227,228	3615367M1	221-75	230
3546391M92	930-11	411-420	3582952M1	144-225	142,146,148	3599462M92	221-3	219-228	3615707M93	740-28	393
3546391M92	930-5	411-420	3582953M91	144-127	148,149	3599463M92	200-7	219,227	3615918M1	108-35	123
3546391M92	930-80	411-417,419,420	3583029M3	231-63	231	3599464M92	200-8	220,228	3615919M3	108-42	124,125
3546937M91	150-125	161-163	3583237M1	875-1	240	3599491M92	200-61	219-227	3615921M3	108-40	124
3547012M93	200-254L	224,229	3583285M1	975-1	209	3599492M91	200-70	227-229	3615949M2	574-7	178,180
3547287M92	920-10	401,402,406-408	3583286M1	975-2	209	3599494M92	200-62	221,223,228	3616060M1	565-75	369
3547287M92	920-4	401-410	3583342M6	303-46	278	3599496M93	200-63	221,223,228,231	3616209M1	762-48	398
3547503M95	150-119	161,167	3583363M1	108-56	125	3599573M3	154-228	155,167	3616223M92	760-42	398
3549613M91	640-31	368	3583486M2	200-252	230	3599679M92	495-50	337,339,340	3616224M2	762-46	398
3549614M91	640-29	368	3583491M1	231-64	230	3599705M91	485-41	331,332	3616474M1	108-51	125
35504	117-3	126,128	3583530M2	371-34	293,294	3599709M92	150-90	155	3616478M91	760-40	398
3550411M2	154-243	160-163,167	3583543M2	60-3	116	3599710M91	2935-58	172	3616512M91	144-123	148,149
3550890M1	154-246	161,167	3583619M1	409-34	310	3599722M91	482-1	324	3616538M92	420-31	304
3550896M1	422-29	302	3583620M2	409-38	310	3599738M1	485-45	331	3616578M1	627-6	189
3551414M93	150-113	161-163	3583941M1	875-1	240	3599804M2	331-1	281	3616579M2	625-6	178,180
3551425M91	154-247	162,167	358890X1	6284-3	266	3599859M1	693-10	386	3616701M1	961-1	209
3551641M92	150-112	161,162	358913X1	6284-9	268	3600102M91	181-3	210	3616931M4	108-43	124
3551956M91	625-11	183,184	358969X1	6284-4	266,267	3600103M91	181-3	210	3617178M91	144-271	148
3552207M1	153-237	160,161	359136X1	687-2	385	3600189M91	570-11	367	3617180M91	144-37	147-149
3552228M1	15-13	32-34	359236X1	6340-1	363	3600200M91	165-120	171	3617184M91	144-129	149
3552682M92	920-10	401,402,406-408	3595070M91	144-33	147	3600207M94	229-13	240	3617197M2	231-65	230
3552682M92	920-4	401-410	3595132M92	107-3	123	3600242M91	200-402L	224	3617198M3	231-66	231
3552682M92	920-108	401-405,407,408	3595133M92	107-4	123	3600243M91	200-403L	224	3617341M2	417-43	305
3553259M91	200-270	230	3595134M92	107-5	123	36047	170-1	196	3617596M1	413-45	312
3554660M91	372-59	296	3595175M1	569-1	176,177,179,180	3609064M1	420-26	301	3617649M91	422-55	304
3554816M92	958-9	202	3595202M91	565-1	368	3609079M1	420-26	301	3617651M91	422-54	303,304
3557269M1	423-22	302	3595383M91	565-2	368	3610268M92	200-9	222,223,226,228	3617652M91	422-20	303,304
3557565M91	851-3	438	3595500M1	161-23	176	3610271M92	200-8	220-228	3617653M91	422-21	304
3557706M93	150-112	161,162	3595501M1	162-23	176,188	3610274M92	221-38	225-227	3617693M1	187-25	207
3557707M94	150-113	161-163	3595503M1	161-24	176,188	3610281M92	221-65	224,227-229	3617865M1	961-1	209
3557708M94	150-126	162,163	3595504M2	410-4	311	361031X1	556-10	274	3617901M2	416-19	303,304
35587344	126-2	129	3595518M1	161-22	176	3610357M2	684-11	385	3617902M3	416-17	303,304
355988X1	6284-10	268	3595519M1	162-22	176	3610878M91	468-1	324	3618001M3	640-48	369
35630	950-1	203	3595519M1	162-142	183-184	3610879M91	469-11	324	3618117M2	958-47	202
35648	950-1	203	3595527M91	495-35	336,339	3610942M91	162-12	175,177,188	3618290M91	150-83	157
35676	96-2	173-175,182	3595554M91	221-69	227,228	3610998M91	417-36	302	3618433M2	4072-9A	453
35677	96-2	173-175,182	3595741M92	485-40	331,332	3611085M91	615-7	378	3618474M3	153-143	157,159,165
3580014M1	154-130	158,159,166	3595762M91	409-4	309	3611132M1	161-78	176,177,188	3618477M4	154-234	157,167
3580177M91	760-44	398	3595763M91	409-3	309	3611133M1	162-78	176,177,188	3618626M92	150-60	158
3580723M1	161-77	179,180,187	3596204M1	153-40	156,165	3611473M1	330-6	281	3618628M92	150-59	158,159
3580724M1	162-77	179,180,187	3596265M92	200-62	221,223,228	3611482M2	303-36	277	3618630M92	150-58	157,159
3580944M92	200-76	231	3596266M92	200-8	220-228	3611493M2	303-37	277	3618632M92	150-57	157
3580946M2	221-76	231	3596772M92	409-6	309	3611532M1	967-58	205	3618640M1	154-239	158,167
3580997M1	979-1	209	3596773M92	409-5	309	3611533M1	967-53	205	3618641M1	154-237	158,159,167
3580998M1	979-2	209	3596774M92	409-8	309	3611536M1	967-55	205	3618642M1	154-245	158,167
3581032M2	625-5	178	3596775M92	409-7	309	3611558M1	686-12	385	3618643M1	154-233	157,167
3581141M2	409-33	310	3596776M91	417-39	302	3611576M91	920-108	401-405,407,408	3618662M1	240-40	179,180,181
3581142M2	409-35	310	3596778M91	417-40	302	3611652M1	153-39	156,165	3618693M1	479-44	326,327,328
3581143M2	409-37	310	3596785M92	410-5	311	3611776M1	372-36	290	3618906M1	920-108	401-405,407,408
3581387M1	920-50	400,401,403,404	3596851M2	962-3	207	3611781M91	1931-13	216	3618906M1	920-74	403-405
3581388M1	920-50	400,401,403,404	3597064M92	107-3	123	3611854M91	565-9	368	3618906M1	920-132	404,405
3581474M91	967-25	206	3597065M92	107-4	123	3611931M91	920-108	401-405,407,408	3618906M1	920-156	404,405
3581576M3	930-38	416-418	3597066M92	107-5	123	3612115M1	144-30	141,142,144	3618907M1	920-50	400,401,403,404
3581576M3	930-181	417,418	3597096M91	221-36	225-227,231	3612130M1	372-36	290	3618908M1	920-74	403-405
3581576M3	930-44	418	3597357M92	1980-7	434	3612442M1	339-1	283-284	3618908M1	920-132	404,405
3581611M1	144-34	143,144	3597359M91	1987-9	435	3612895M1	569-1	176-179,180	3618908M1	920-156	404,405
3581635M1	144-290	144,145,147,149	3597371M2	930-10	411-414,416,420	3612930M1	144-226	144	3619005M00	200-252	230
358178X1	666-1	383	3597371M2	930-4	411-414,416,420	3613536M91	417-37	302	3619008M92	150-61	158,159
3581876M3	108-33	123	3597371M2	930-87	411-414,416,420	3613537M91	417-38	302	3619018M91	1920-7	215
3581877M2	108-54	125	3597371M2	930-90	411-414,416,420	3613538M1	423-20	302	3619026M1	154-131	158,159,166
3581878M3	108-55	125	3597372M2	930-11	411-420	3613539M1	422-45	302	3619054M1	154-132	159,166
3581879M2	108-39	124	3597372M2	930-5	411-420	3613975M91	200-72	227,231	3619055M1	154-133	158,159,166
3581959M1	154-238	158,167	3597372M2	930-80	411-417,419,420	3613976M91	221-72	227,229,231	3619056M1	153-133	159,165
3581996M93	760-41	398	3597372M2	930-180	414,417	3614022M92	4200-39	192	3619057M1	153-134	158,159,165
3581999M1	761-47	397,398	3597420M91	565-2	368	3614023M91	4200-36	192	3619073M1	486-53	353
3582000M1	762-49	398	3597426M3	930-10	411-414,416,420	3614259M91	172-41	194	3619084M91	144-124	148
3582043M2	704-3	389	3597426M3	930-4	411-414,416,420	3614284M91	172-42	194	3619105M2	108-44	125
3582044M2	851-8	438	3597426M3	930-87	411-414,416,420	3614419M1	154-232	156,167	3619135M1	371-33	293
3582085M92	422-53	303	3597426M3	930-90	411-414,416,420	3614420M2	153-232	156,165	3619137M1	371-35	293
3582118M1	165-121	171	3597426M3	930-4							

REFERENCES INTERCHANGEABLES
CROSS REFERENCES

OEM OEM	Réf. Ref.	Page Page	OEM OEM	Réf. Ref.	Page Page	OEM OEM	Réf. Ref.	Page Page	OEM OEM	Réf. Ref.	Page Page
3619180M93	954-5	204	3637059M1	73-91	86	3637489M91	90-13	108-115	3637784M91	40-1	61,68
3619343M1	376-18	293	3637075M91	82-12	95-104	3637492M1	36-24	43,57	3637789M91	1-4	12,17
3619344M1	376-19	293	3637081M1	80-11	99	3637494M1	36-7C	55	3637791M91	3-28	14,17,18
3619345M1	376-20	293,294	3637097M91	71-91	86	3637498M1	73-53	83,84,88-90	3637792M91	3-28A	14,17,18
3619346M1	376-21	293,294	3637098M91	72-91	86	3637499M91	1-26	11,18	3637793M91	3-28B	14,17,18
3619356M91	144-228	145,146	3637148M1	117-156	127	3637501M91	2-76	11,18	3637794M91	3-28C	14,17,18
3619375M3	108-45	125	3637169M1	117-167	128	3637502M91	2-76A	11,18	3637939M1	151-3	155,164
3619445M2	954-4	204	3637185M1	117-158	127	3637503M91	2-76B	11,18	3637942M1	84-7	94,102
3619489M12	920-50	400,401,403,404	3637195M1	117-135	126-128	3637504M91	2-76C	11,18	3637978M91	144-230	141,152
3619490M00	920-50	400,401,403,404	3637241M91	90-54	109	3637505M91	3-28	14,17,18	3638093M1	56-1	95-104
3619594M1	240-41	178,180,185	3637248M91	90-51	109	3637506M91	3-28A	14,17,18	3638105M1	12-11	22,23
3619656M2	108-41	124	3637249M91	130-91	134	3637507M91	3-28B	14,17,18	3638108M1	80-13	96,100,102,103
3619712M1	625-9	179,180	3637257M91	141-133	134,137,140	3637508M91	3-28C	14,17,18	3638183M91	920-4	401-410
3620121M91	1987-11	435	3637280M91	33-24	47,54,56	3637509M91	3-76	11,18	3638184M1	50-5	78,81
3620123M91	1987-9	435	3637286M91	100-6	117,118,120	3637510M91	3-76A	11,18	3638185M1	50-4	78,81
3620124M91	1987-16	435	3637287M91	100-7	117,118,120	3637511M91	3-76B	11,18	3638219M91	82-13	94,102
3620125M91	1987-18	435	3637288M91	100-3	117,119,120	3637512M91	3-76C	11,18	3638220M91	82-14	95-97
3620127M91	1987-20	435	3637290M91	100-10	117,118,120	3637513M91	33-72	43,51,56	3638235M91	34-72	43,51,58
3620128M91	1987-22	435	3637292M91	100-19	117,120	3637514M91	33-72	43,51,56	3638251M91	141-10	133,140
3620129M91	1987-12	435	3637300M91	100-8	117,118,120	3637516M91	33-69	45,49,50,52,53,56	3638262M1	117-150	127
36202	151-2	155,164	3637301M1	151-3	155,164	3637518M1	12-10	20,28	3638273M91	33-73	45,49,56
3620400M92	221-63	224,230	3637306M91	144-128	141,143,150-153	3637519M1	12-12	24,27	3638291M1	111-25	178,180,185,186
3620401M91	200-1	218,219,230	3637307M91	100-4	117,120	3637527M1	41-19	61,68	3638291M1	111-63	178-180,185,186
3620401M91	200-1L	218,219,230	3637309M91	100-9	118,120	3637528M1	42-26	61,68,77	3638294M1	73-53	83,84,88-90
3620402M91	200-2	218,221	3637319M1	117-37	126,128	3637529M1	43-5	61,62,68,77	3638297M91	71-52	83,84,88-90
3620403M91	200-3	221	3637320M1	117-36	126,128	3637532M91	6051-1	78,81	3638305M1	73-56	85,88
3620406M91	200-66	222	3637322M91	100-71	117,120	3637537M1	80-7	95,96,98,102-104	3638309M91	1-1	11,18
3620407M91	200-4	219,220	3637331M1	36-22	45,49,50,52,53,57	3637539M1	80-6	94,102	3638321M91	40-1	61,68
3620408M91	200-6	221,222	3637332M1	35-22	45,49,50,52,57	3637572M1	141-10	133,140	3638322M1	151-1	155
3620409M91	212-4	219-222	3637333M1	36-23	46,49,52,53,57	3637573M91	142-9	133,140	3638358M1	73-52	83,84,88-90
3620410M92	221-1	218,219,221,230	3637334M1	35-23	46,49,52,57	3637574M91	142-8	131,138,140	3638366M91	71-52	83,84,88-90
3620410M92	221-1L	218,219,221,230	3637338M91	100-5	117,119,120	3637576M1	131-8	135	3638368M91	90-17	114,115
3620411M91	212-1	218,219,221,230	3637341M1	73-52	83,84,88-90	3637579M1	144-29	141-144,152	3638378M1	2940-040	154
3620412M91	221-65	224,227-229	3637351M91	91-1	108,111	3637592M91	90-18	114,115	3638379M1	2940-050	154
3620413M91	200-68	224,228,229,231	3637352M91	90-15	114,115	3637593M1	93-10	114,115	3638398M1	2940-060	154
3620414M91	200-69	227,229	3637353M91	90-16	114,115	3637597M1	144-100	141,143	3638399M1	2940-070	154
3620417M91	212-6	219-223,225-228	3637359M91	90-1	108,111	3637598M91	144-229	143,150,151,153	3638520M91	1-72	15
3620501M5	3102-236	431	3637360M91	33-74	45,49,50,52,53,56	3637600M91	72-10	83,84,89,90	3638431M1	75-113	86
3620502M6	3102-237	431	3637361M91	71-53	83,88-90	3637601M91	72-12	85,88	3638460M91	33-108	46,48,50,52,54,56
3620504M5	3102-230	431	3637362M91	71-52	83,84,88-90	3637607M91	30-103	41	3638461M1	74-11	83,84,88-90
3620506M5	3102-212	431	3637363M91	71-52	83,84,88-90	3637608M91	30-110	41	3638473M1	1-2	12,18
3620507M5	3102-239	431	3637372M91	130-4	132,138	3637609M91	30-102	41	3638482M1	74-11	83,84,88-90
3620509M5	3102-233	431	3637384M91	40-5	62,69	3637610M91	30-107	41	3638495M91	30-107	41
3620512M5	3102-227	431	3637389M91	40-3	61,68	3637611M91	30-108	41	3638510M1	111-25	178,180,185,186
3620513M5	3102-218	431	3637392M91	25-2	32,33,39,40	3637612M91	30-115	42	3638510M1	111-63	178-180,185,186
3620514M5	3102-200	431	3637395M91	6051-2	78,80,81	3637613M91	30-117	42	3638515M91	72-10	83,84,89,90
3620516M6	3102-201	431	3637397M91	79-1	93	3637615M91	131-4	132,138	3638520M1	17-5	22-30
3620518M5	3102-206	431	3637399M91	1-5	11,18	3637616M1	43-24	61,62,68,77	3638539M1	2940-070	154
3620520M5	3102-215	431	3637401M91	1-7	12-14,17,18	3637617M1	11-32	25	3638545M91	71-5	82,89
3620600M91	404-1	300	3637402M91	1-8	13,17,18	3637618M1	13-35	25	3638562M1	75-113	86
3620602M91	403-1	300	3637404M91	1-32	15,17	3637620M91	34-175	48,59	3638563M1	161-60	177,185,187
3621011M1	97-2	175-188	3637406M91	1-32	15,17	3637622M1	37-175	48	3638577M91	71-8	83,90
3624121M91	585-14	356	3637408M91	1-29	15,17	3637623M1(2x)	37-175	48	3638579M1	56-1	95-104
3624903M91	585-16	356	3637410M91	1-5	11,18	3637624M1	28-26	37	3638580M91	30-114S	42
363296X1	442-6	318	3637411M91	130-8	132,136,137,139	3637625M1	28-32	37	3638581M91	30-103	41
363593X1	666-1	383	3637414M91	100-17	117	3637631M91	2-48	16	3638582M91	30-110	41
363654X1	502-1A	346	3637417M1	161-141	185	3637632M91(7x)	2-48A	16	3638583M91	30-102	41
3637019M91	1-72	15	3637421M1	81-10	95-104	3637633M91(7x)	2-48B	16	3638584M91	30-108	41
3637020M91	2-52	15	3637422M91	91-3	108,110,111	3637636M1	6-30	16	3638585M91	30-116	42
3637021M91	2-52A	15	3637426M91	141-4	132,138,140	3637639M1	73-122	87	3638586M91	30-117	42
3637022M91	2-52B	15	3637427M91	141-12	134,140	3637640M1	41-51	65	3638595M91	90-51	109
3637023M91	2-52C	15	3637428M91	31-7	43,44,51,53	3637641M1	43-51	65,77	3638596M91	90-54	109
3637024M91	3-29	15,17	3637429M91	31-16	44	3637642M1	42-51	65,77	3638606M1	97-43	175
3637025M91	3-29A	15,17	3637430M91	31-12	45	3637643M1	74-122	87	3638609M1	33-174	48,56
3637026M91	3-29B	15,17	3637431M91	31-13S	46,49	3637645M1	117-137	127	3638610M91	34-174	48,59
3637027M91	3-29C	15,17	3637432M91	31-9	45,51,53	3637646M91	100-82	119	3638623M91	127-1	129
3637028M91	25-11	33-36,38-40	3637439M91	25-1	32,33,39,40	3637648M91	131-200	135	3638624M91	127-2	129
3637029M1	26-2	33-36,38-40	3637443M91	14-3	22,24,26,27,29	3637650M1	143-56	149	3638625M91	127-3	129
3637030M1	27-2	33-36,38-40	3637444M91	71-52	83,84,88-90	3637651M1	60-2	116	3638659M91	71-91	86
3637031M1	36-22	45,49,50,52,53,57	3637445M91	131-2	131,138	3637652M1	97-34	179,187	3638660M91	72-91	86
3637031M91	33-108	46,48,50,52,54,56	3637446M91	131-13	133,139	3637653M91	90-57	109	3638661M91	71-10	83,84,88,90
3637032M1	35-22	45,49,50,52,57	3637454M91	1-1	11,18	3637658M91	34-71	43,51,58	3638663M91	71-52	83,84,88-90
3637032M91	34-90	48,52,59	3637458M91	1-34	12,18	3637661M91	31-109	47,50	3638691M1	73-4	82,89
3637033M1	36-23	46,49,52,53,57	3637466M91	130-49	134,137	3637662M91	32-109	47,50	3638694M91	130-91	134
3637033M91	34-110	47,50,52,59	3637468M91	130-31	133,137,139	3637675M1	151-1	155	3638697M91	71-91	86
3637034M1	35-23	46,49,52,57	3637470M91	90-3	108,110,111	3637678M1	45-60	70,75	3638700M1	147-20	148,149
3637034M91	25-3	33-36,38-40	3637471M91	90-2	108,111	3637729M91	100-72	118	3638709M91	71-90	84,89,90
3637035M91	33-109	47,50,56	3637480M91	131-49	134,137	3637752M91	1-2	12,18	3638721M91	34-74	45,49,50,52,53,58
3637041M1	47-1	71,72,73,74,75,76	3637482M91	131-8	132-139	3637754M91	33-73	45,49,56	3638755M91	33-108	46,48,50,52,54,56
3637042M1	42-71	64	3637483M91	131-31	133,137,139	3637765M91	31-8S	53			

**REFERENCES INTERCHANGEABLES
CROSS REFERENCES**

OEM OEM	Réf. Ref.	Page Page	OEM OEM	Réf. Ref.	Page Page	OEM OEM	Réf. Ref.	Page Page	OEM OEM	Réf. Ref.	Page Page
3638767M91	2-4C	15,17	3639492M1	30-119	42	3641075M91	72-113	84,85,88,90	3641894M1	17-4	20,21,28,29
3638769M91	72-12	85,88	3639493M1	30-108	41	3641085M1	12-10	20,28	364777X1	6444-3	361,362
3638771M91	72-57	85,88	3639494M1	30-106	41	3641094M91	127-5	129	3648755M91	150-120	163
3638780M1	17-3	22,24,26,27,29	3639495M1	30-100	41	3641095M91	127-7	129	3648900M1	144-237	145
3638796M91	33-108	46,48,50,52,54,56	3639496M1	30-101	41	3641120M1	96-1	173	3649058M1	144-238	142
3638798M91	131-91	134	3639514M1	32-74	45,49,50,52	3641156M91	127-8	129	3649081M1	154-126	162,163
3638805M1	2940-030	154	3639521M1	131-4	132,138	3641171M91	90-54	109	3649157M91	417-42	302
3638813M1	920-4	401-410	3639541M1	1-4	12,17	3641182M1	73-8	83,90	3650746M91	930-10	411-414,416,420
3638814M1	920-4	401-410	3639592M1	59-1	399,406	3641196M91	32-22	47,50,55	3650746M91	930-4	411-414,416,420
3638814M1	920-5	406,407	3639658M1	6412-2	357	3641219M91	130-8	132,136,137,139	3650746M91	930-87	411-414,416,420
3638814M1	920-24	406-408	3639674M1	144-231	147	3641221M1	17-5	22-30	3650746M91	930-90	411-414,416,420
3638845M1	73-11	83,84,88,90	3639680M1	144-232	142	3641222M91	31-79S	54	3650779M91	150-122	163
3638864M1	72-90	89	3639683M1	144-233	144	3641223M91	31-77S	54	3651229M1	144-275	145
3638866M91	31-15	46,53	3639685M1	144-234	144	3641224M1	17-5	22-30	365801X1	6489-8	353
3638883M91	31-8	43,44,51,53	3639686M1	144-298	147	3641225M91	2-45A	15	3658635M92	150-115	162-163
3638884M91	31-15S	53	3639687M1	144-273	150	3641226M91	2-45B	15	3660548M92	150-113	161-163
3638885M91	31-70	47,50,54	3639692M1	144-235	147	3641227M91	2-45C	15	3660549M92	150-112	160-162
3638886M91	31-70S	54	3639696M1	100-32	118,120	3641230M91	72-12	85,88	366434X1	6444-5	362
3638887M91	31-78S	54	3639738M1	117-35	126,128	3641250M91	130-4	132,138	36811112	74-9	83,90
3638888M91	31-14	45,52,53	3639798M1	933-2	423	364125X1	2940-040	154	36811114	74-11	83,84,88-90
3638892M91	30-181S	41	3639874M1	35-20	49,57	3641262M91	127-6	129	36811115	74-8	82,89
3638919M91	42-9A	77	3639877M1	43-16	63,66,69,77	3641263M91	130-31	133,137,139	36811122	74-11	83,84,88-90
3638920M91	42-9C	77	3639878M1	42-9	62,64,66,67,69,77	3641273M1	75-106	83-85,88-90	36811126	74-11	83,84,88-90
3638922M1	41-18	62,63,64,66,67,69	3639880M1	43-5	61,62,68,77	3641283M91	131-174	132,136,139	36811131	74-11	83,84,88-90
3638929M1	44-51	73	3639947M1	27-1	32,33,39,40	3641297M1	42-9B	77	36811132	74-11	83,84,88-90
3638931M1	46-51	73	3639965M1	47-7	71	3641308M91	100-32	118,120	36811133	74-11	83,84,88-90
3638934M1	45-51	73	3639969M1	142-16	134,140	3641310M91	130-10	136	36811412	74-15	85,88
3638939M1	75-122	87	3639996M1	142-31	134,140	3641313M91	72-57	85,88	36811422	74-17	85,88
3638940M91	90-59	109	3640094M1	74-90	84	3641314M91	130-49	134,137	36811431	74-17	85,88
3638949M91	131-200	135	3640096M1	73-90	84,85,89,90	3641315M91	131-8	132-139	36811436	74-17	85,88
3638954M1	117-170	127	364012X1	442-20	318	3641316M91	34-108	46,48,50,52,54,59	36811443	74-32	85,88
3638959M1	28-27	37	3640166M1	6687-2	122	3641332M91	131-49	134,137	36811445	74-32	85,88
3638960M1	73-123	87	3640234M1	34-18C	55	3641333M91	131-31	133,137,139	36811451	74-17	85,88
3638961M91	42-52	65,77	3640285M1	90-11	108	3641338M91	130-6	131,138	36812113	73-7	83,90
3638962M91	43-52	65,77	3640287M1	90-55	110	3641340M91	71-8	83,90	36812118	73-8	83,90
3638963M1	74-123	87	3640323M91	131-2	131,138	3641351M91	131-4	132,138	36812122	73-3	82,89
3638964M1	45-52	73	3640324M91	131-4	132,138	3641352M91	131-2	131,138	36812125	73-7	83,90
3638966M1	46-52	73	3640326M91	131-8	132-139	3641355M91	130-32	134	36812126	73-8	83,90
3638970M1	35-174	48,57	3640327M91	131-31	133,137,139	3641363M91	130-14	133,139	36812127	73-4A	82,89
3638981M91	71-10	83,84,88,90	3640328M91	131-49	134,137	3641364M91	130-13	133	36812131	73-30	83
3638982M91	71-53	83,88-90	3640333M91	31-108	46,48,50,52,54	3641365M91	130-48	134	36812133	73-4	82,89
3638983M91	71-52	83,84,88-90	3640334M91	32-108	46,48,50,52	3641378M91	131-10	136	36812136	73-3	82,89
3638989M91	33-109	47,50,56	3640352M1	117-168	128	3641379M91	131-32	134	36812138	73-8	83,90
3638990M91	130-49	134,137	3640383M91	131-174	132,136,139	3641380M91	131-88	134	36812139	73-4	82,89
3638994M91	130-49	134,137	3640406M1	75-106	83-85,88-90	3641382M91	131-48	134	36812141	73-7	83,90
3638998M91	130-31	133,137,139	3640441M91	32-4	43,44,51	3641383M91	131-8	132-139	36812142	73-3	82,89
3638999M91	130-31	133,137,139	3640442M91	32-12	45,49,55	3641385M91	131-13	133,139	36812143	73-30	83
3639007M1	11-2	22,24,26,27,29	3640444M91	33-12C	55	3641392M91	131-2	131,138	36812315	73-11	83,84,88,90
3639011M1	11-21	21	3640473M1	144-236	147	3641393M91	131-4	132,138	36812323	73-11	83,84,88,90
3639012M1	11-34	26	3640482M91	31-5	43,44,51,53	3641397M91	12-10	20,28	36812324	73-31	84,90
3639013M1	100-6	117,118,120	3640483M91	31-39S	50	3641399M1	73-4	82,89	36812326	73-11	83,84,88,90
3639030M1	33-20	49,56	3640484M91	31-70	47,50,54	3641400M91	100-25	118,120	36812327	73-31	84,90
3639034M1	131-11	136	3640485M91	31-5S	53	3641402M91	100-10	117,118,120	36812331	73-11	83,84,88,90
3639047M1	32-5	43,44,51	3640488M1	167-2	169	3641405M1	2940-025	154	36812333	73-11	83,84,88,90
3639048M1	32-7	43,44,51	3640514M91	72-90	89	3641408M91	100-8	117,118,120	36812334	73-11	83,84,88,90
3639050M1	32-13	46,49	3640515M91	72-90	89	3641413M91	32-78	47,50	36812335	73-31	84,90
3639051M1	32-69	45,49,50,52	3640519M91	130-90	137	3641425M91	32-24	47	36812336	73-11	83,84,88,90
3639160M1	73-6	83	3640556M1	66-3	168	3641738M1	80-11	99	36812337	73-31	84,90
3639193M1	21-25	31	3640565M91	130-8	132,136,137,139	3641739M1	81-12	95-104	36812338	73-11	83,84,88,90
3639218M1	44-4	71,72,73,74,75,76	3640573M1	6441-2	361	3641740M1	81-14	95-104	36812341	73-11	83,84,88,90
3639238M1	42-15	62,77	3640583M91	71-5	82,89	3641766M1	147-15	144-147,150-153	36812342	73-11	83,84,88,90
3639239M1	43-15	62,77	3640593M91	33-108	46,48,50,52,54,56	3641794M91	90-53	110,111	36812347	73-31	84,90
3639297M1	124-1	105	3640597M1	42-39	63,64,67,69,77	3641806M91	33-176	47,52,54,56	36812348	73-31	84,90
3639319M1	85-13	106	3640672M1	117-153	127	3641821M1	74-109	86	36812349	73-11	83,84,88,90
3639403M1	919-1	410	3640673M1	117-152	127	3641823M91	130-6	131,138	36812351	73-11	83,84,88,90
3639424M1	169-11	193	3640674M1	117-147	127	3641825M91	1-26	11,18	36812352	73-52	83,84,88-90
3639434M1	33-73	45,49,56	3640676M1	41-17	62,63,64,66,67,69	3641826M1	12-10	20,28	36812528	73-12	85,88
3639438M1	33-74	45,49,50,52,53,56	3640719M91	72-10	83,84,89,90	3641832M91	130-8	132,136,137,139	36812532	73-12	85,88
3639441M1	71-10	83,84,88,90	3640754M91	131-90	137	3641840M91	80-12	97,102,104	36812535	73-35	85,88
3639445M1	71-34	85	3640765M1	124-2	105	3641843M91	80-13	96,100,102,103	36812542	73-12	85,88
3639450M1	71-10	83,84,88,90	3640783M91	71-52	83,84,88-90	3641855M91	101-31	118,120	36812546	73-12	85,88
3639467M1	31-7S	53	3640873M91	2-45	15	3641858M91	1-5	11,18	36812547	73-35	85,88
3639468M1	31-201S	49	3640874M91	1-32	15,17	3641859M91	130-32	134	36812548	73-12	85,88
3639469M1	31-3S	53	3640877M91	40-6	62,66,67,69	3641860M91	130-91	134	36812604	73-35	85,88
3639471M1	31-4	43,44,51	3640908M91	90-52	110,111	3641861M91	130-10	136	36812607	73-56	85,88
3639472M1	31-202S	49	3640916M1	73-91	86	3641865M1	73-90	84,85,89,90	36812613	73-56	85,88
3639485M1	30-105S	41	3640921M91	141-131	133,139,140	3641869M91	130-90	137	36815386	75-107	83
3639486M1	30-105S	41	3640923M1	117-155	126	3641880M91	130-32	134	36816707	75-110	85,88
3639487M1	30-111	41	3640944M1	74-105	84,89,90	3641886M91	130-49	134,137	36816725	75-110	85,88
3639489M1	30-112	41	3640961M1	117-136	126	3641887M91	130-13	133	36816733	75-110	85,88
3639490M1	30-113	41	3641031M91	1-73	14	3641891M1	74-105	84,89,90	36817134	17-1	20,21,28,29
3639491M1	30-118	42	3641035M91	13							

REFERENCES INTERCHANGEABLES
CROSS REFERENCES

OEM OEM	Réf. Ref.	Page Page	OEM OEM	Réf. Ref.	Page Page	OEM OEM	Réf. Ref.	Page Page	OEM OEM	Réf. Ref.	Page Page
36817141	17-2	21,29	36883119	13-1	20,21,28,29	3713026M2	108-52	125	881728M1+		
36817157	17-5	22-30	3688V006	75-105	82,89	3713027M2	108-36	124	881729M1+		
36817164	17-3	22,24,26,27,29	3697027M91	471-25	327	3713028M1	172-51	195	3534030X1	579-1	370
36817166	17-3	22,24,26,27,29	3697028M91	470-25	327	3713029M1	172-52	195	375756X1	26-1	32,33,39,40
36817168	17-1	20,21,28,29	3697161M91	200-71	226,227	3713084M1	172-55	195	3759020M92	108-26	123
36817173	17-3	22,24,26,27,29	3697163M91	221-71	223,226,227,231	3713130M91	1931-16	216	3759021M91	108-1	123
36817174	17-2	21,29	3697208M91	221-68	223,226,227,231	3713134M91	1931-14	216	3759022M91	108-2	123
36817417	17-9	23,30	3697463M1	105-6	122	3713137M1	181-42	211	3759023M91	108-3	123
36819127	73-4	82,89	3697992M1	372-37	290	3713189M2	153-135	159,165	3759024M91	108-4	124
3681A008	74-13	84,90	3698015M91	920-10	401,402,406-408	3713194M1	1980-43	434	3759025M91	108-5	124
3681A011	74-11	83,84,88-90	3698015M91	920-11	401,402,410	3713195M1	1987-45	435	3759026M91	108-18	124
3681A021	74-90	84	3698015M91	920-108	401-405,407,408	3713264M91	200-76	231	3759496M91	511-4	349
3681A026	74-11	83,84,88-90	3698016M91	920-17	399,400,401,403	3713266M1	221-76	231	3759661M1	6489-15	352
3681A027	74-11	83,84,88-90	3698016M91	920-81	400	3713267M00	200-75KT	230	3759758M92	511-2	349
3681A028	74-105	84,89,90	3698016M91	920-82	400,401	3713341M1	1955-472	211	3760514M1	292-2	256-260
3681A032	74-105	84,89,90	3698016M91	920-10	401,402,406-408	3713440M2	108-49	125	3760524M91	920-10	401,402,406-408
3681A033	74-107	82	3698016M91	920-11	401,402,410	3713667M4	958-10	202	3760524M91	920-4	401-410
3681A049	74-108	84,85,89,90	3698016M91	920-108	401-405,407,408	3713668M4	958-32	202	3760524M91	920-11	401,402,410
3681A051	74-106	86	3698016M91	920-74	403-405	3713669M2	958-11	202	3760524M91	920-108	401-405,407,408
3681C001	74-91	86	3698016M91	920-155	404	3713798M91	181-52	211	3760524M91	920-74	403-405
3681C003	74-109	86	3698016M91	920-132	404,405	3713799M91	181-53	211	3760524M91	920-155	404
3681E006	73-4	82,89	3698016M91	920-156	404,405	3713903M91	200-54K	230	3760524M91	920-132	404,405
3681E008	73-53	83,84,88-90	3698240M1	6298-1	267,268	3713911M92	1912-138	215	3760524M91	920-156	404,405
3681E009	73-90	84,85,89,90	3698735M91	409-25	309	3713930M1	486-56	353	376091X1	118-2	129
3681E012	73-53	83,84,88-90	3698736M91	409-26	309	3713952M91	1920-7	215	3761359M91	108-15	125
3681E014	73-53	83,84,88-90	3698907M1	371-30	290	3714122M4	196-6	231	3761360M91	108-16	125
3681E015	73-4	82,89	3698937M1	154-229	155	3714137M1	1884-50	204	3761361M91	108-17	125
3681E016	73-53	83,84,88-90	3699303M92	198-11	217	3714138M1	1884-51	204	3761473M1	692-41	386
3681E017	73-90	84,85,89,90	3699304M92	198-12	217	3714184M92	1918-66	213	3761474M1	692-20	386
3681E018	73-52	83,84,88-90	3699444M1	441-27	319	3714185M91	1918-65	213	3761475M1	692-18	386
3681E021	73-11	83,84,88,90	3699483M91	1918-77	213	3714194M91	1987-38	435	3761476M1	692-40	386
3681E023	73-8	83,90	3699490M92	1912-148	215	3714356M4	166-13	172	3761477M1	692-19	386
3681E024	73-4	82,89	3699491M92	1912-149	215	3714416M2	6492-6	364	3761478M1	692-17	386
3681E025	73-90	84,85,89,90	3699800M2	371-3	291,292	3714453M1	240-85	180,181	3761507M91	144-240	144
3681E028	73-107	82	3699801M1	305-22	276,277	3714536M1	409-39	310	3761802M1	168-14	193
3681E033	73-90	84,85,89,90	3699802M2	6427-2	365	3714733M2	172-49	195	376190X1	21-35	31
3681E034	73-53	83,84,88-90	3699806M91	168-4	193	3714894M1	144-272	148	3762112M1	484-1	324
3681E036	73-52	83,84,88-90	3700134M1	422-44	302	3714922M1	920-50	400,401,403,404	3762118M91	108-8	125
3681E037	73-90	84,85,89,90	3700447M92	150-92	156	3714944M1	920-108	401-405,407,408	3762526M91	172-41	194
3681E042	73-83	85,89,90	3700469M2	485-43	332	3714944M1	920-74	403-405	3762527M91	172-42	194
3681H201	73-91	86	3700507M1	153-231	156,165	3714944M1	920-156	404,405	3762579M1	172-39	194
3681H202	73-56	85,88	3700527M1	231-70	225-229,231	3715250M2	422-48	305	3762580M1	172-40	194
3681H203	73-91	86	3700535M91	1918-87	213	3715286M4	172-50	195	3762587M91	6099-8	121
3681H205	73-91	86	3700536M1	1918-77	213	3715438M1	4071-23	455	3762589M91	6099-7	121
3681H208	73-91	86	3700656M1	144-239	144	3715539M1	476-17	328	3763362M94	930-11	411-420
3681K003	75-106	83-85,88-90	3700687M91	471-24	326,327	3715610M1	1980-44	434	3763362M94	930-5	411-420
3681K005	75-106	83-85,88-90	3700688M91	470-24	326,327	3715712M94	976-5	209	3763362M94	930-80	411-417,419,420
3681M005	75-113	86	3700937M92	198-13	217	3715822M4	958-34	202	3763362M94	930-180	414,417
3681M007	75-113	86	3701002M91	200-71	226,227	3715838M4	958-33	202	3763363M92	930-10	411-414,416,420
3681T008	17-5	22-30	3701003M91	200-272	223	3715973M1	108-48	125	3763363M92	930-4	411-414,416,420
3681T009	17-5	22-30	3701005M91	565-1	368	3716210M1	371-39	294	3763363M92	930-87	411-414,416,420
3681T012	17-5	22-30	3701006M91	565-9	368	3716223M1	422-57	304	3763363M92	930-90	411-414,416,420
3681T013	17-5	22-30	3701008M91	221-68	223,226,227,231	3716252M2	416-20	304	3763364M91	6416-1	356
3681T018	17-5	22-30	3701009M91	221-71	223,226,227,231	3716253M1	416-22	304	3763366M91	6416-2	356
36821335	167-3	169	3701011M91	221-72	227,229,231	3716335M1	416-23	304	3763386M92	1912-147	214
368233X1	551-20	274	3701014M92	200-405L	231	3716370M3	640-53	369	3763387M92	1912-147	214
36883119	13-1	20,21,28,29	3701015M92	200-72	227,231	3716920M91	417-45	305	3763744M91	570-6	367
3683183M91	920-10	401,402,406-408	3701695M1	329-1	281	3716932M1	423-24	305	376399X1	758-1	396
3683183M91	920-4	401-410	3701712M91	107-3	123	3716933M1	422-51	305	3764024M1	495-63	341,343,344
3683183M91	920-5	406,407	3701713M91	107-4	123	37228	919-4	410	3764027M2	495-61	341,343,344
3683183M91	920-69	406,407	3701714M91	107-5	123	37229	919-1	410	3764028M2	495-62	341-344
3683183M91	920-24	406-408	3701928M91	841-4	426	37332415	6687-2	122	3764132M1	495-65	341,343,344
36833167	66-1	168	3701931M91	841-5	426	37354312	6079-1	99	3764160M1	354-22	362
36834152	147-15	144-147,150-153	3701954M91	774-3	390	373601X1	484-1	324	3764266M1	353-17	362
36834169	147-12	141,142,150,152	3701955M91	774-2	390	37365	919-2	410	3764286M1	495-64	341,343,344
36835442	147-22	142,151,153	371153X1	6452-16	358	37371271	50-6	78,79,80,81	3764543M1	353-15	362
3683R009	147-16	145,151,153	3712072M1	486-58	353	37371281	50-7	78,79,80,81	3764544M1	354-20	362
3684A004	147-20	148,149	3712078M1	486-46	353	3737A091	50-5	78,81	3764593M1	354-24	362
3684N017	147-17	146,149	3712152M1	486-57	353	3737A101	50-4	78,81	3764595M1	6410-34	293,359
36861757	147-19	147,148,150,151	3712206M1	853-9	438	37395	919-4	410	3764686M1	6403-53	355
36862134	66-3	168	3712250M3	560-33	379	37396	919-1	410	3764875M1	6462-18	357
36862143	66-2	168	3712289M4	640-47	369	37397	919-5	410	3764883M91	6403-57	355
36862159	66-3	168	3712470M1	6492-9	364	37398	919-2	410	3765013M91	6403-59	355
36862189	66-3	168	3712529M91	172-48	195	37399	919-1	410	376501X1	88-1	107
36862201	147-14	143,144,150-153	3712531M1	144-270	379	37403	919-5	410	3765113M1	6403-55	355
36862225	147-31	143,144	3712611M2	441-38	320	37408	919-2	410	376518X1	114-1	129
3687W017	147-21	152	3712668M3	186-13	208	37417471	94-6	112,113	376524X1	9156-26	130
36883106	13-1	20,21,28,29	3712728M3	976-2	209	37448	919-2	410	376525X1	9156-27	130
36883107	13-5	21	3712873M1	6418-5	364	375100X1	741-3	318	376526X1	9156-28	130
36883108	13-2	22-24,26,27,29	3712952M1	172-54	195	375108X1+			376527X1	9156-29	130
36883115	13-5	21	3713022M2	108-46	125	188909M1+			3765414M91	585-13	356
36883116	13-2	22-29	3713025M6	108-47	125	881727M1+			3765690M1	353-6	362

Les références des pièces sont indicatives.
Nos pièces ne sont pas d'origine

Part numbers are quoted for reference purposes only.
Our parts and accessories are not original.



"THE RELIABLE

REFERENCES INTERCHANGEABLES
CROSS REFERENCES

OEM OEM	Réf. Ref.	Page Page	OEM OEM	Réf. Ref.	Page Page	OEM OEM	Réf. Ref.	Page Page	OEM OEM	Réf. Ref.	Page Page
3765808M91	585-15	356	3785846M1	443-9	316	3808159M92	150-110	159	3819355M91	920-155	404
376588X1	94-4	112,113	3787790M1	172-56	195	3808161M1	689-5	385	3819355M91	920-132	404,405
376831X1	2940-055	154	3787791M1	172-48	195	3808704M1	144-247	145	3819355M91	920-156	404,405
3771122M92	625-14	175,176,179,180	3788017M91	920-108	401-405,407,408	3808705M1	144-248	145	3819457M1	166-14	172
3771408M1	557-1	270,271	3788017M91	920-74	403-405	3808730M1	144-249	148	3819666M91	296-10	232
37718552	83-1	95-100,102-104	3788017M91	920-156	404,405	3808788M91	1987-41	435	3819666M92	296-10	232
3772137M1	165-26	171	3790002M1	240-39	180	3808790M91	1987-44	435	3819719M1	15-1	32-34,38-40
3772138M1	165-27	170	3790388M2	7611-6	381	3808847M1	6418-6	365	3819720M1	15-16	35,36
3772138M1	165-27PB	170	3790419M2	640-52	369	3808918M2	967-34	206	3820083M1	153-230	156,165
37721551	61-3	116	3790493M1	422-50	305	3808919M2	967-36	206	3820313M1	154-241	158,167
3772942M1	908-5	373	3790722M1	600-4	374	3808994M91	1912-137	215	3820492M1	153-229	156,165
3773740M91	580-3	370	3790734M3	196-2	231	3809149M1	967-33	206	3820620M91	150-16	156,157,164
3774344M1	153-228	156,165	3790735M2	196-4	231	3809150M1	967-26	206	3820765M1	686-13	385
3774612M91	565-1	368	3791085M1	353-23	287	3809151M1	967-27	206	3820874M92	774-5	390
3774613M91	565-9	368	3792287M1	641-27	180,181	3809174M1	144-294	145	3821313M91	108-20	123
3774616M92	570-14	367	3792346M1	196-5	231	3809175M1	144-250	148	3821548M91	560-1	379
3774617M92	570-1	367	3792448M2	196-3	231	3809345M91	181-50	210	3821747M1	4000-74T	454
3774617M92	570-1E	367	3794298M1	908-5	373	3809346M91	181-51	210	3821781M91	165-26	171
3774618M91	570-6	367	3795093M1	422-52	305	3809488M1	967-38	206	3821782M91	165-27	170
3774635M1	154-230	156,167	3795094M1	423-25	305	3809489M1	967-37	206	3821818M91	930-11	411-420
3774636M1	154-231	156,167	3795274M1	321-1	280	3809490M2	967-28	206	3821818M91	930-5	411-420
3774649M91	570-5	367	3795286M11	186-13	208	3809491M2	967-29	206	3821818M91	930-80	411-417,419,420
3774836M1	510-4	349	3795499M1	422-56	304	3809498M1	967-30	206	3821818M91	930-180	414,417
377631X1	6284-3	266	3795628M12	186-18	208	3809499M2	967-35	206	3821974M91	920-108	401-405,407,408
37764181	98-2	192	3797563M11	640-47	369	3809505M1	153-139	159,165	3821974M91	920-156	404,405
37764251	98-1	192	3800194M91	565-106	369	3809543M91	1920-8	215	3821976M92	920-132	404,405
37766362	146-3	141,152	3800195M91	565-107	369	3809592M92	958-5	202	3821976M92	920-156	404,405
37766363	146-3	141,152	3800196M91	565-229	369	3809602M91	1918-76	213	3821978M92	920-132	404,405
3777203M1	154-134	159,166	3800250M1	6492-7	365	3809603M91	1918-77	213	3821978M92	920-156	404,405
3777243M1	144-300	149	3800251M1	6492-8	365	3809632M91	1912-136	215	3823621M91	930-38	416-418
3777247M1	930-44	418	3800305M91	625-4	176,177,179,180	3809797M2	967-39	206	3823621M91	930-181	417,418
3777260M2	153-136	159,165	3801052M1	686-13	385	3809967M92	172-47	195	3823623M1	686-13	385
377749X1	442-10	315	3801056M1	685-12	385	3810085M91	1920-7	215	3823624M1	686-13	385
3777602M2	4000-90	455	3801057M1	684-10	385	3810188M92	150-129	158	3823652M1	920-17	399,400,401,403
3777648M91	1987-43	435	3801167M1	153-137	159,165	3810344M1	154-138	159,166	3823652M1	920-1	399,400,403,410
3777677M1	920-50	400,401,403,404	3801168M1	154-136	158,159,166	3810420M91	144-251	145	3823652M1	920-81	400
3777677M1	920-132	404,405	3804552M2	4012-40	454	3810480M1	486-56	353	3823652M1	920-82	400,401
3777677M1	920-156	404,405	3804553M2	4012-37	454	3810587M95	410-47	312	3823652M1	920-108	401-405,407,408
3777698M92	1980-6	434	3804585M91	198-14	217	3810970M1	685-12	385	3823652M1	920-74	403-405
3778074M91	150-128	159	3804658M1	4038-9	454	3811653M1	153-140	158,165	3823652M1	920-155	404
3780888M1	154-135	159,166	3804659M1	4039-9	454	3811654M1	154-139	158,167	3823652M1	920-132	404,405
37781051	65-6	168	3804666M2	4069-3	454	3811660M91	409-45	310	3823652M1	920-156	404,405
37781251	65-1	168	3804667M2	4069-4	454	3811818M91	108-23	124	3823652M1	920-92	400,401,403,404
37781333	65-5	168	3804694M3	4072-44	454	3812271M1	967-32	206	3823653M1	920-108	401-405,407,408
37781341	65-2	168	3804726M2	4073-27	454	3812275M1	967-31	206	3823653M1	920-74	403-405
37781571	65-3	168	3804759M1	870-53	430	3812439M91	1987-42	435	3823653M1	920-155	404
37781781	65-7	168	3805131M91	108-19	125	3812633M1	967-40	206	3823653M1	920-132	404,405
3778581M2	409-42	310	3805354M1	870-53	430	3813027M91	108-24	125	3823653M1	920-156	404,405
3778639M1	108-37	124	3805472M91	108-21	124	3813360M1	485-44	332	3823654M2	920-78	401-405,407,408
3778741M1	409-41	310	3805642M1	4038-9T	454	3813361M1	951-2	203	3823654M2	920-104	403-405
3778904M1	958-35	202	3805643M1	4039-9T	454	3813541M92	198-14	217	3823654M2	920-155	404
3778975M2	144-241	149	3805747M91	198-16	217	3813542M92	198-15	217	3823654M2	920-132	404,405
3779379M91	144-242	148	3806187M91	409-44	310	3813543M92	198-16	217	3823654M2	920-156	404,405
3780138M91	144-243	146,149	3806222M91	198-17	217	3813544M92	198-17	217	3824032M1	161-12	175,177,188
3780289M1	409-40	310	3806223M91	198-15	217	3814953M2	4000-70	454	3824033M1	162-12	175,177,188
3780299M1	111-202	180,181	3806378M92	108-22	124	3814954M2	4000-70T	454	3824035M1	161-78	176,177,188
3780603M3	144-253	146	3806573M2	4000-72T	454	3815255M2	144-252	146	3824036M1	162-78	176,177,188
3780603M91	144-292	146	3806580M4	4000-71	454	3815256M2	144-253	146	3824041M1	967-38	206
3780605M91	144-244	146	3806581M3	4072-44T	454	3815257M1	144-253	146	3824042M1	967-37	206
3780606M91	144-245	146,149	3806584M2	4012-40T	454	3815365M92	774-4	390	3824173M91	158-5	191
3780607M91	144-293	146	3806585M2	4012-37T	454	3815726M91	108-25	123	3824711M92	181-62	211
3780608M91	144-101	146,147	3806588M2	4012-50	454	3815980M1	442-16	316	3824712M91	181-61	211
3780616M91	144-246	146	3806589M2	4012-49	454	3815981M1	443-8	316	3827534M1	442-18	316
3780634M1	920-108	401-405,407,408	3806590M2	4069-3T	454	3816909M91	565-106	369	3827583M91	449-4	321
3780634M1	920-74	403-405	3806591M2	4069-4T	454	3816910M91	565-107	369	3900173M91	222-2	239
3780634M1	920-132	404,405	3806610M92	853-5	438	3816911M91	565-229	369	3900182M1	517-1	349
3780634M1	920-156	404,405	3806611M92	853-4	438	3816912M91	565-230	369	3900183M1	520-1	350
3781116M1	150-128	159	3806612M92	853-7	438	3816914M91	560-114	369	3900184M91	530-6	350
3781442M92	930-180	414,417	3806613M92	853-6	438	3816915M91	565-226	369	3900188M1	535-8	350
3781444M92	1912-151	215	3806614M92	851-9	438	3816970M1	442-17	316	3900192M1	521-1	350
3781445M92	1912-150	215	3806618M91	851-8	438	3816971M1	443-13	316	3900193M1	515-1	349
3782386M1	161-124	181	3806702M2	4012-50T	454	3817514M1	153-235	158,166	3900202M1	545-1	351
3782387M1	162-124	181	3806703M2	4012-49T	454	3817582M1	144-254	146	3900210M1	546-1	351
378246X1	357-6	288	3806704M4	4000-73T	454	3817639M91	682-10	385	3900212M91	516-1	349
378249X1	357-7	288	3806767M1	870-53	430	3818834M2	154-240	158,167	3900218M1	547-1	351
3782575M3	409-43	310	3807508M1	153-138	158,159,165	3819255M91	920-81	400	3900225M91	200-251	218
3782749M1	108-53	125	3807509M1	154-137	158,166	3819255M91	920-82	400,401	3900234M92	416-25	303
3784889M2	930-38	416-418	3807653M92	172-46	195	3819355M91	920-17	399,400,401,403	3900287M91	585-23	371
3784889M2	930-44	418	3807654M92	172-45	195	3819355M91	920-10	401,402,406-408	3900289M91	585-22	371
3784890M1	930-38	416-418	3807655M92	172-44	195	3819355M91	920-11	401,402,410	3900290M91	411-18	311
3784890M1	930-181	417,418	3808136M1	691-10	386	3819355M91	920-108	401-405,407,408	3900316M91	860-108	428
3785334M1	108-38	124	3808158M3	150-129	158	3819355M91	920-74	403-405	3900317M91	860-109	428

Les références des pièces sont indicatives.
Nos pièces ne sont pas d'origine

Part numbers are quoted for reference purposes only.
Our parts

REFERENCES INTERCHANGEABLES
CROSS REFERENCES

OEM OEM	Réf. Ref.	Page Page	OEM OEM	Réf. Ref.	Page Page	OEM OEM	Réf. Ref.	Page Page	OEM OEM	Réf. Ref.	Page Page
3900318M91	860-107	428	3904254M91	920-155	404	40318	31-12	45	41158144	34-71	43,51,58
3900320M91	860-125	428	3904254M91	920-132	404,405	40319	31-13S	46,49	41158145	34-74	45,49,50,52,53,58
3900321M91	860-111	428	3904254M91	920-156	404,405	40325	31-5	43,44,51,53	41159411	3-28	14,17,18
3900322M91	860-112	428	3904627M91	570-7	367	40326	31-70	47,50,54	41159631	3-29	15,17
3900322M92	860-111	428	390859X1	372-69	298	4069	231-23	218	41159632A	3-29A	15,17
3900323M92	860-127	428	390876X1	353-11	289,296,298,361	407044	982-1	93	41159633B	3-29B	15,17
3900324M92	860-114	428	390984X1	6412-2	357	408335	980-1	93	41159634C	3-29C	15,17
3900328M91	860-17	428	3910266M1	147-13	142,151,153	41112533	296-10	232	4115R305	50-7	78,79,80,81
3900329M91	860-18	428	3910267M1	75-120	83	41112535	296-10	232	4115R306	50-6	78,79,80,81
3900330M91	860-19	428	3910274M1	75-111	83,90	41112565	296-10	232	4115Y001	34-183	46,53,59
3900331M91	860-20	428	3910276M91	420-1	301	41112574	296-10	232	4119015	97-2	175-188
3900332M91	860-24	428	3910278M91	421-9	301	41112796	296-10	232	41312055	130-2	131,138
3900333M91	860-3	427	3910279M91	412-10	301	41112797	296-10	232	41312063	130-136	132,138
3900345M92	860-117	428	3910280M91	421-8	301	41115005	82-15	95,103	41312154	130-2	131,138
3900346M91	860-119	428	3910292M91	421-1	301	41115023	82-4	95-97,100,102-104	41312159	130-3	131,138
3900347M91	860-121	428	391129X1	6284-7	268	41115025	91-1	108,111	41312161	130-6	131,138
3900423M91	229-14	240	391162X1	304-3	276,277	41115056	82-11	98,101	41312167	130-136	132,138
3900547M1	219-3	239	391261X1	304-2	276,278	41115057	82-10	98,101	41312214	130-6	131,138
3900562M91	860-106	428	391336X1	6410-5	297,360	41115084	91-3	108,110,111	41312245	130-8	132,136,137,139
3900613M2	9604-130	92,279	391337X1	6410-6	360	41115085	91-3	108,110,111	41312246	130-8	132,136,137,139
3900614M91	860-6	428	391338X1	372-65	298	41115086	91-1	108,111	41312248	130-8	132,136,137,139
3900618M1	4047-6A	444,445	391339X1	352-16	288,362	41115324	121-1	105	41312254	130-12	132
3900628M2	1980-23	434	391346X1	358-7	289	41115367	121-1	105	41312265	130-10	136
3901083M91	860-113	428	391870X1	446-32	320	41117084	296-10	232	41312267	130-12	132
3901084M91	860-126	428	392022X1	6444-2	361	4111A008	82-16	99	41312302	130-8	132,136,137,139
3901103M2	1980-22	434	392040X1	372-57	296	4111A013	82-12	95-104	41312304	130-12	132
3901192M91	932-7	423	392060X1	479-41	329	4111A015	82-13	94,102	41312309	130-6	131,138
3901196M91	932-3	423	392082X1	6489-5	352	4111A016	82-14	95-97	41312321	130-10	136
3901455M91	413-43	312	392084X1	6440-2	361	4111K006	90-15	114,115	41312323	130-8	132,136,137,139
3901456M91	413-44	312	392101X1	355-5	361	4111K008	90-16	114,115	41312344	130-8	132,136,137,139
3901462M1	161-118	179,186	392107X1	6407-1	357,361	4111K011	90-15	114,115	41312352	130-10	136
3901463M1	162-118	179,186	392108X1	6407-4	297,357,361	4111K022	90-15	114,115	41312357	130-6	131,138
3901464M1	161-119	179,180,186	392151X1	372-61	298	4111K024	90-16	114,115	41312365	130-12	132
3901465M1	162-119	179,180,186	392184X1	6452-12	358	4111K026	90-15	114,115	41312366	130-8	132,136,137,139
3901475M1	161-120	179,180	392191X1	231-69	229	4111K028	90-16	114,115	41312387	130-12	132
3901476M1	162-120	179,180	392210X1	6682-18	387	4111K035	90-15	114,115	41312388	130-12	132
3901477M1	161-121	180,181	392215X1	461-52	323	4111K037	90-16	114,115	41312402	130-10	136
3901478M1	162-121	180,181	392283X1	6679-18	387	4111K038	90-15	114,115	41312404	130-10	136
3901525M91	71-19	83	392420X1	443-10	316	4111K041	90-16	114,115	41312411	130-10	136
3901567M91	411-47	312	392438X1	6489-11	353	4111K051	90-15	114,115	41312416	130-3	131,138
3901824M91	495-58	339,340	392501X1	441-33	314,319,320	4111K053	90-16	114,115	41312419	130-13	133
3901825M91	495-33	336,339,340	392513X1	353-27	289	4111K055	90-17	114,115	41312424	130-10	136
3901826M91	871-39	430	392756X1	355-7	361	4111K057	90-18	114,115	41312428	130-10	136
3902038M91	860-124	428	392775X1	376-26	298	4111K059	90-17	114,115	41312441	130-10	136
3902040M91	860-115	428	392825X1	376-23	296,298	4111K062	90-18	114,115	41312444	130-10	136
3902042M91	860-122	428	3930274M92	9604-130	92	4111K064	90-15	114,115	41312449	130-12	132
3902043M91	860-120	428	3930501R91	920-11	401,402,410	4111K066	90-16	114,115	41312459	130-213	132
3902044M91	860-123	428	3930504R1	920-108	401-405,407,408	41154181	50-6	78,79,80,81	41312461	130-12	132
3902048M91	860-116	428	3930505R1	930-4	411-414,416,420	41154182	50-7	78,79,80,81	41312462	130-12	132
3902049M91	860-118	428	3930506R1	930-11	411-420	41154183	50-6	78,79,80,81	41312463	130-12	132
3902081M91	200-54K		3930507R1	930-10	411-414,416,420	41154184	50-7	78,79,80,81	41312464	130-12	132
3902107M92	908-3	373	3930904M1	9604-103	91	41157201	2-3	12-14,17,18	41312466	130-12	132
3902108M92	908-4	373	3930906M1	9604-221	92	41158005	34-78	45,47,49,50,54,58	41312467	130-12	132
3902121M4	872-43	430	3930908M1	9604-102	91	41158012	34-11	43,51,58	41312468	130-12	132
3902123M1	4039-2	455	3930935M5	3102-203	431	41158017	34-75	47,50,54,58	41312469	130-12	132
3902124M1	4038-2	455	3930936M6	3102-204	431	41158022	34-57	46,49,52,53,58	41312471	130-12	132
3902130M1	4069-7	455	3930937M7	3102-205	431	41158025	34-12	45-55,58	41312472	130-12	132
3902131M1	4069-8	455	3930938M5	3102-224	431	41158025C	34-12C	55	41312473	130-12	132
3902140M1	870-63	430	3930939M6	3102-225	431	41158026	34-12	45-55,58	41312475	130-12	132
3902141M1	4071-22	455	3930940M7	3102-226	431	41158026	34-12T	47,58	41312477	130-10	136
3902148M1	4000-56	455	3931493M91	30-184	42	41158026C	34-12C	55	41312479	130-10	136
3902149M1	4014-6	455	393994X1	6284-7	268	41158026T	34-12T	47,58	41312481	130-10	136
3902150M1	4014-7	455	394014X1	461-47	323	41158029	34-18	47,55,58	41312487	130-3	131,138
3902321M91	1988-3	434	394301X1	2940-040	154	41158029C	34-18C	55	41312488	130-6	131,138
3902337M2	1980-6	434	394601X1	6407-1	357,361	41158031	34-23	47,50,58	41312489	130-6	131,138
3902430M1	851-3	438	394602X1	355-5	361	41158032	34-24	47,54,55,58	41312494	130-2	131,138
3902436M2	967-41	206	394603X1	6407-4	297,357,361	41158032A	34-24A	55	41312495	130-3	131,138
3902712M1	768-1	396	394608X1	371-28	295,298	41158038	34-13	46,49,53,58	41312502	130-10	136
3902782M1	162-165	181	394881X1	357-8	289	41158041	34-12	45-55,58	41312504	130-6	131,138
3902783M1	161-165	181	395521X1	6408-4	297,360	41158041C	34-12C	55	41312505	130-6	131,138
3903030M1	161-125	180	395522X1	6407-18	297,357	41158044	34-9	45,49,51,53,58	41312511	130-136	132,138
3903031M1	162-125	180	395523X1	6409-3	357	41158045	34-10	45,51,58	41312549	130-10	136
3904110M91	585-18	371	395527X1	6408-5	297,360	41158057	34-7	43,44,51,53,58	41312551	130-137	132,136,139
3904124M91	585-24	372	395542X1	442-22	316	41158058	34-4	43,44,51,58	41312552	130-8	132,136,137,139
3904169M1	4170-18	436,437	395559X1	376-14	296	41158059	34-4	43,44,51,58	41312554	130-8	132,136,137,139
3904170M92	585-20	371	395563X1	358-2	290	41158063	34-3	43,44,53,58	41312557	130-10	136
3904250M91	922-11	410	4002	760-1	395	41158065	34-8	43,44,51,53,58	41312558	130-10	136
3904254M91	920-10	401,402,406-408	4008	762-1	395	41158069	34-3	43,44,53,58	41312559	130-10	136
3904254M91	920-4	401-410	40267	31-16	44	41158085	34-16	44,58	41312561	130-8	132,136,137,139
3904254M91	920-11	401,402,410	40283	31-39S	50	41158118	34-21	46,52,58	41312562	130-8	132,136,137,139
3904254M91	920-108	401-405,407,408	40315	31-7	43,44,51,53	41158121	34-20	49,58	41312564	130-8	132,136,137,139
3904254M91	920-74	403-405	40317	31-9	45,51,53	41158132	34-59	46,58	41312566	130-8	132,136,137,139

Les références des pièces sont indicatives.
Nos pièces ne sont pas d'origine

Part numbers are quoted for reference purposes only.
Our parts and accessories are not original.



"THE REL

**REFERENCES INTERCHANGEABLES
CROSS REFERENCES**

OEM OEM	Réf. Ref.	Page Page	OEM OEM	Réf. Ref.	Page Page	OEM OEM	Réf. Ref.	Page Page	OEM OEM	Réf. Ref.	Page Page
41312567	130-8	132,136,137,139	41313243	130-31	133,137,139	4132F056	90-53	110,111	422249M91	71-12	85,88
41312568	130-8	132,136,137,139	41313245	130-31	133,137,139	4132F057	90-54	109	422256M91	117-148	127
41312574	130-136	132,138	41313252	130-31	133,137,139	414136M1	154-4	155,164,166	422268M91	33-173	46,48,50,52,54,56
41312576	130-6	131,138	41313261	130-31	133,137,139	41422027	14-1	20,21,28,29	422279M91	1-32	15,17
41312589	130-6	131,138	41313269	130-13	133	41422034	14-1	20,21,28,29	422282M91	90-53	110,111
41312591	130-6	131,138	41313272	130-14	133,139	41424238	75-108	83,90	422284M1	28-40	36
41312593	130-14	133,139	41313403	130-6	131,138	41424239	75-109	83,90	422292M1	117-154	126,127
41312622	130-10	136	41313458	130-4	132,138	41425608	6121-1	105	422233M1	47-63	72,73,75,76
41312626	130-10	136	41314019	90-2	108,111	4153	151-1	155	422235M1	73-91	86
41312629	130-10	136	41314021	90-1	108,111	41733043	90-6	112,113	422235M91	30-115	42
41312636	130-10	136	41314026	90-1	108,111	41733056	90-6	112,113	422240M1	147-21	152
41312649	130-10	136	41314033	90-2	108,111	41733062	90-6	112,113	422244M91	100-44	118
41312651	130-10	136	41314038	90-3	108,110,111	41733066	90-6	112,113	422245M91	100-5	117,119,120
41312654	130-10	136	41314042	90-2	108,111	41733082	90-6	112,113	422245M91	71-7	83,90
41312661	130-14	133,139	41314043	90-1	108,111	41733402	90-6	112,113	422245M91	131-197	134
41312664	130-14	133,139	41314044	90-4	110	4181A009	34-13	46,49,53,58	422245M91	130-197	134
41312673	130-10	136	41314046	90-1	108,111	4181A013	34-90	48,52,59	422246M91	130-199	134
41312676	130-10	136	41314049	90-11	108	4181A014	34-110	47,50,52,59	422246M91	131-91	134
41312679	130-10	136	41314051	90-11	108	4181A015	34-110	47,50,52,59	422246M91	71-115	86
41312681	130-48	134	41314053	90-4	110	4181A016	34-90	48,52,59	422247M1	167-2	169
41312682	130-10	136	41314054	90-3	108,110,111	4181A017	34-72	43,51,58	422248M91	71-5	82,89
41312689	130-8	132,136,137,139	41314058	90-5	109,110	4181A019	34-110	47,50,52,59	422248M1	26-2	33-36,38-40
41312691	130-10	136	41314061	90-3	108,110,111	4181A021	34-90	48,52,59	422249M91	71-59	85,88
41312693	130-10	136	41314062	90-5	109,110	4181A022	34-74	45,49,50,52,53,58	422250M1	73-52	83,84,88-90
41312697	130-10	136	41314067	90-5	109,110	4181A026	34-108	46,48,50,52,54,59	422252M91	71-35	85,88
41312698	130-10	136	41314073	90-1	108,111	4181A033	34-173	46,48,50,52,54,59	422253M1	73-90	84,85,89,90
41312699	130-10	136	41314078	90-1	108,111	4181A035	34-177	43,59	422256M91	75-107	83
41312703	130-48	134	41314079	90-1	108,111	4181A041	34-176	47,52,54,59	422257M91	72-57	85,88
41312733	130-8	132,136,137,139	41314087	90-2	108,111	4181A045	34-182	46,50,52,59	422256M91	71-3	82,89
41312739	130-8	132,136,137,139	41314088	90-2	108,111	4181A051	34-178	43,59	422256M91	18-1	31
41312743	130-8	132,136,137,139	41314089	90-11	108	4200076M91	600-6	374	4222570M1	36-177	43,57
41312744	130-6	131,138	41314091	90-11	108	4222001M91	130-196	137	4222571M91	2-77	11
41312747	130-13	133	41314096	90-4	110	4222002M91	130-31	133,137,139	4222572M91	2-77A	11
41312749	130-48	134	41314106	90-12	108,110	4222011M1	147-14	143,144,150-153	4222573M91	2-77B	11
41312756	130-8	132,136,137,139	41314109	90-11	108	4222012M1	21-38	31	4222574M91	2-77C	11
41312768	130-6	131,138	41314113	90-12	108,110	4222013M91	71-90	84,89,90	4222577M91	34-177	43,59
41312783	130-6	131,138	41314131	90-4	110	4222017M1	56-1	95--104	422259M1	42-60	61,77
41312784	130-2	131,138	41314136	90-23	109,110	4222028M91	130-91	134	4222580M1	43-60	61,77
41312785	130-6	131,138	41314137	90-14	109,110	4222037M91	1-1	11,18	4222584M1	45-17	70
41312786	130-6	131,138	41314164	90-2	108,111	4222043M1	21-50	31	4222586M1	46-13	70
41312797	130-14	133,139	41314165	90-1	108,111	4222050M1	66-2	168	4222588M1	73-107	82
41312806	130-48	134	41314182	90-3	108,110,111	4222052M91	131-91	134	4222611M1	81-13	94
41312807	130-48	134	41314187	90-1	108,111	4222053M91	34-183	46,53,59	4222633M1	75-105	82,89
41312823	130-14	133,139	41314189	90-2	108,111	4222057M1	147-12	141,142,150,152	4222648M1	74-107	82
41312828	130-13	133	41317006	130-4	132,138	4222068M1	17-1	20,21,28,29	4222706M91	34-176	47,52,54,59
41312874	130-6	131,138	4131A011	130-8	132,136,137,139	4222069M1	54-3	78,79,80,81	4222721M91	1-78	11
41312911	130-8	132,136,137,139	4131A013	130-8	132,136,137,139	4222071M91	130-71	133,136	4222722M91	33-178	43,56
41312913	130-8	132,136,137,139	4131A021	130-8	132,136,137,139	4222076M91	30-113	41	4222723M91	34-178	43,59
41312914	130-8	132,136,137,139	4131A029	130-8	132,136,137,139	4222090M91	100-19	117,120	4222733M1	117-149	126
41312915	130-8	132,136,137,139	4131A034	130-8	132,136,137,139	4222091M91	100-8	117,118,120	4222759M91	71-81	82
41312963	130-6	131,138	4131A044	130-194	133,135,137	4222093M91	100-9	118,120	4222760M91	72-105	82
41312964	130-6	131,138	4131A046	130-198	133,135	4222094M91	100-3	117,119,120	4222808M91	71-30	83
41312965	130-4	132,138	4131A048	130-194	133,135,137	4222104M91	100-7	117,118,120	4222810M91	40-3	61,68
41312966	130-6	131,138	4131A049	130-198	133,135	4222105M91	100-25	118,120	4222815M91	72-5	82,89
41312967	130-6	131,138	4131E007	130-90	137	4222106M91	100-32	118,120	4222819M91	33-173	46,48,50,52,54,56
41312978	130-4	132,138	4131E011	130-91	134	4222107M91	100-6	117,118,120	4222820M1	12-18	23
41313010	130-49	134,137	4131E012	130-90	137	4222108M91	100-10	117,118,120	4222840M91	130-194	133,135,137
41313018	130-10	136	4131E015	130-91	134	4222109M91	101-4	117,120	4222841M91	131-198	133,135,137
41313025	130-49	134,137	4132F012	90-55	110	4222110M91	101-5	117,118,120	4222845M1	143-55	145-149,151-153
41313027	130-32	134	4132F014	90-13	108-115	4222111M91	100-4	117,120	4222846M91	141-132	133,135,137,140
41313029	130-88	134	4132F015	90-14	109,110	4222118M91	101-3	117,120	4222851M1	147-17	146,149
41313033	130-49	134,137	4132F016	90-23	109,110	4222120M91	130-88	134	4222864M91	71-82	84,85,89,90
41313045	130-10	136	4132F021	90-13	108-15	4222121M91	100-71	117,120	4222894M1	42-62	63,64,67,69,77
41313047	130-49	134,137	4132F022	90-51	109	4222122M1	73-7	83,90	4222896M1	43-62	63,64,67,69,77
41313048	130-196	137	4132F023	90-54	109	4222123M91	130-48	134	4222905M1	117-35	126,128
41313049	130-49	134,137	4132F024	90-53	110,111	4222124M1	73-53	83,84,88-90	4222906M1	147-19	147,148,150,151
41313058	130-32	134	4132F025	90-52	110,111	4222125M91	101-10	117,118,120	4222908M91	30-185	42
41313059	130-49	134,137	4132F026	90-53	110,111	4222128M1	35-173	46,48,50,52,57	4222909M91	30-183	42
41313062	130-49	134,137	4132F027	90-52	110,111	4222129M1	36-173	46,48,50,52,54,57	4222910M91	30-186	42
41313065	130-49	134,137	4132F028	90-51	109	4222131M1	28-41	34,36,39,40	4222920M91	71-8	83,90
41313068	130-10	136	4132F029	90-54	109	4222132M1	26-13	34,36,39,40	4222928M91	72-9	83,90
41313075	130-48	134	4132F034	90-53	110,111	4222134M91	33-173	46,48,50,52,54,56	4222929M91	72-12	85,88
41313079	130-32	134	4132F035	90-52	110,111	4222136M91	34-173	46,48,50,52,54,59	4222934M1	75-109	83,90
41313201	130-8	132,136,137,139	4132F038	90-53	110,111	4222141M1	46-14	72,73,75,76	4222938M1	41-60	61
41313212	130-71	133,136	4132F039	90-52	110,111	4222147M91	43-61	63,64,77	4222942M1	74-17	85,88
41313218	130-31	133,137,139	4132F041	90-13	108-115	4222149M91	42-61	63,64,77	4222949M91	33-182	46,50,52,56
41313225	130-8	132,136,137,139	4132F043	90-51	109	4222174M91	100-17	117	4222950M91	34-182	46,50,52,59
41313227	130-31	133,137,139	4132F044	90-54	109	4222191M1	117-157	127	4222952M1	42-63	63,67,69,77
41313228	130-71	133,136	4132F045	90-53	110,111	4222198M91	101-31	118,120	4222955M1	45-64	72,75,76
41313231	130-8	132,136,137,139	4132F046	90-52	110,111	4222229M91	72-91	86	4222957M1	43-63	63,67,69,77
41313232	130-8	132,136,137,139	4132F051	90-52	110,111	4222300M1	117-151	126-128	4222977M1	117-146	126,128
41313											

REFERENCES INTERCHANGEABLES
CROSS REFERENCES

OEM OEM	Réf. Ref.	Page Page	OEM OEM	Réf. Ref.	Page Page	OEM OEM	Réf. Ref.	Page Page	OEM OEM	Réf. Ref.	Page Page
4223002M1	75-121	84,90	4223939M91	1-42	14,17	4224613M91	72-91	86	526666M91	200-1L	218,219,230
4223004M1	17-15	23,26	4223940M91	72-9	83,90	4224621M91	71-90	84,89,90	527904M93	570-2	367
4223005M91	71-10	83,84,88,90	4223957M91	144-103	148	4224623M91	71-90	84,89,90	529900M91	144-299	145
4223006M91	71-52	83,84,88,90	4223959M1	141-132	133,135,137,140	4224624M1	143-60	149	530316M1	4170-18	436,437
4223021M1	17-9	23,30	4223964M1	41-9	62	4224635M91	71-82	84,85,89,90	530718M92	241-1	269
4223073M1	41-17	62,63,64,66,67,69	4223976M1	117-162	126,128	4224639M1	143-55	145-149,151-153	531505M91	151-19	157
4223074M1	41-18	62,63,64,66,67,69	4223987M1	41-61	63,64,67,69	4224667M91	71-115	86	531607M93	650-2	379
4223075M91	50-7	78,79,80,81	4224006M1	45-64	72,75,76	4224668M91	71-115	86	532300M94	6099-8	121
4223076M91	50-6	78,79,80,81	4224007M1	47-64	72,75,76	4224674M91	72-106	86	532779M92	144-260	151
4223089M91	71-90	84,89,90	4224027M91	71-81	82	4224675M91	131-198	133,135,137	532883M1	301-2	276
4223090M91	72-113	84,85,88,90	4224032M91	72-107	82	4224699M91	72-114	84,85	532888M2	308-2	276,277
4223101M91	130-194	133,135,137	4224047M91	131-198	133,135,137	423153	981-1	93	532897M1	303-18	276
4223103M91	131-198	133,135,137	4224049M91	72-57	85,88	4232169M1	497-191	341,344	532899M1	303-17	276
4223104M91	72-114	84,85	4224053M91	71-59	85,88	4232264M1	495-247	341,344	532956M1	346-1	283
4223109M91	130-193	134	4224054M91	1-22	15,17	4233305M1	144-255	152	533183M1	305-8	276,278
4223114M91	71-109	86	4224055M1	13-5	21	4233443M1	495-246	341,344	533262M2	317-1	265,280
4223123M91	71-9	82,89	4224056M1	13-2	22-24,26,27,29	4234437M1	144-279	152	535126M93	58-8	200
4223128M91	71-108	83	4224057M1	13-1	20,21,28,29	4270017M1	161-126	181	535203M1	153-37	164
4223129M91	72-31	84,90	4224063M91	75-108	83,90	4270018M1	162-126	181	53587	75-4	82,89
4223130M91	71-90	84,89,90	4224090M91	71-59	85,88	4271246M91	1943-16	216	535873M91	417-31	301
4223140M91	2-4	15,17	4224102M91	33-78	43,56	4297	761-3	395	54205305	922-11	410
4223146M1	73-83	85,89,90	4224107M91	90-17	114,115	437195	920-108	401-405,407,408	54205975	921-8	410
4223424M1	147-22	142,151,153	4224108M91	90-18	114,115	437195	920-74	403-405	54213117	913-2	410
4223442M1	47-65	72,73,75,76	4224110M91	90-15	114,115	437195	920-132	404,405	54213780	911-2	410
4223451M91	71-83	85,89	4224111M91	131-13	133,139	437195	920-156	404,405	54217372	925-1	410
4223455M1	41-19	61,68	4224116M1	75-110	85,88	439279	920-108	401-405,407,408	54217859	911-2	410
4223470M91	30-102	41	4224118M91	130-48	134	439279	920-74	403-405	54218811	923-1	410
4223487M1	41-20	61,62,68	4224120M91	72-12	85,88	439279	920-132	404,405	54219368	923-1	410
4223491M91	72-5	82,89	4224141M91	90-16	114,115	439279	920-156	404,405	54219374	912-2	410
4223492M91	72-30	83	4224142M91	72-5	82,89	490011M1	479-2	325,326,327,334	5423590	931-7	423
4223499M91	33-183	46,53,56	4224148M91	14-3	22,24,26,27,29	490019M1	483-1	324	54243781	939-13	422
4223500M91	71-5	82,89	4224152M91	71-35	85,88	491105M1+			54243849	931-6	423
4223501M1	66-1	168	4224154M91	39-4	60	353957X1+			54243853	934-1	423
4223502M91	71-31	84,90	4224155M91	39-5	60	188148M1+			54244938	939-12	422
4223518M91	131-90	137	4224156M91	39-2	60	188359M1	716-5	390	54244973	932-4	423
4223519M1	41-3	61,62,68,69	4224157M91	39-3	60	501365	31-40	44	54244979	933-3	423
4223520M91	71-115	86	4224158M91	39-12	60	501366	31-40	44	54245574	932-4	423
4223521M91	72-91	86	4224159M91	39-15	60	501367	31-40	44	54246285	939-12	422
4223524M91	75-4	82,89	4224160M91	39-13	60	5016260M1	144-256	149	54246654	939-12	422
4223525M91	72-6	83,90	4224161M91	39-40	60	5016603M1	161-127	181	54246662	939-13	422
4223532M91	71-107	82	4224162M91	39-42	60	5016604M1	162-127	181	54246725	939-7	422
4223535M91	71-59	85,88	4224163M91	39-41	60	501923	71-19	83	54247034	939-8	422
4223536M91	71-12	85,88	4224164M91	39-43	60	503676M1	436-2	317	54247379	931-5	423
4223538M91	71-34	85	4224165M91	39-18	60	503727M1	144-125	147	54248227	932-4	423
4223543M91	71-53	83,88,90	4224167M91	71-12	85,88	505E010	919-35	409	54251818	931-3	423
4223566M91	130-90	137	4224172M1	14-1	20,21,28,29	505E045	919-33	409	54255952	931-4	423
4223573M91	71-90	84,89,90	4224186M91	71-10	83,84,88,90	506902M92	173-1	197	54258128	931-6	423
4223580M1	2940-030	154	4224189M91	71-52	83,84,88-90	508545M92	920-80	399	54259517	933-3	423
4223581M1	41-62	63,64,67,69	4224216M91	131-8	132-139	512355M91	200-1	218,219,230	54259592	932-3	423
4223582M1	73-3	82,89	4224245M1	81-1	94,102	512355M91	200-1L	218,219,230	54259688	939-7	422
4223583M91	100-72	118	4224246M91	71-53	83,88-90	513242M1	316-1	280	54263486	932-3	423
4223587M1	17-5	22-30	4224249M91	75-105	82,89	514210M1	321-1	280	54266045	932-3	423
4223732M91	71-115	86	4224291M1	75-110	85,88	514276M1	317-1	265,280	54266463	932-4	423
4223733M91	72-106	86	4224300M1	47-66	70	514958M1	347-2	285	54268141	939-15	422
4223737M1	117-163	126	4224303M91	1-29	15,17	514992M2	734-1	392	54268142	939-16	422
4223739M91	131-198	133,135,137	4224307M91	71-108	83	516068M93	221-1	218,219,221,230	54268382	931-9	423
4223741M91	130-198	133,135	4224316M1	45-63	72,73,75,76	516068M93	221-1L	218,219,221,230	54268462	932-7	423
4223761M1	117-164	127	4224320M91	71-52	83,84,88-90	516467M1	144-257	145	54292376	931-9	423
4223764M91	141-63	135,140	4224323M1	117-161	126	516523M92	258-4	249,250	54324157	951-2	203
4223777M91	141-4	132,138,140	4224325M91	930-90	411-414,416,420	516574M1	697-2	386	55274	33-3	43,44,53,56
4223784M1	73-30	83	4224340M91	930-80	411-417,419,420	518414M1	269-3	254	55275	32-3	43,44
4223797M1	17-2	21,29	4224346M91	71-82	84,85,89,90	518420M1	317-1	265,280	554314M91	2-18	12
4223798M91	1-77	11	4224369M1	72-51	83,84	518476M1	601-2	376-378	554320M91	2-18	12
4223808M91	33-177	43,56	4224377M91	72-107	82	518529M1	303-91	277	554322M91	2-18A	12
4223809M91	33-177	43,56	4224379M1	75-109	83,90	518611M1	446-30	319	554323M91	2-18B	12
4223817M91	72-5	82,89	4224394M91	30-118	42	519127M91	221-63	224,230	554326M91	3-20	12,18
4223818M91	72-107	82	4224398M1	74-106	86	520309M91	154-64	157,166	554332M91	2-20	18
4223832M91	72-5	82,89	4224437M91	71-115	86	520700M4	262-2	252,253	554338M91	3-19	12
4223834M91	72-107	82	4224441M91	130-194	133,135,137	520858M1	551-1	273	55737	33-20	49,56
4223842M1	147-18	146,149,152	4224451M91	100-32	118,120	520909M1	58-18	200	55778	33-5	43,44,51,56
4223849M91	33-179	46,56	4224452M91	74-108	84,85,89,90	521110M1	144-258	147	56205F	35-40	44,57
4223901M91	130-194	133,135,137	4224456M91	33-72	43,51,56	521282M1	317-1	265,280	5651241	117-12	126,128
4223908M91	130-198	133,135	4224457M91	72-113	84,85,88,90	521370M1	144-3	141,142,151-153	570038M1	144-1	142,151,153
4223911M91	72-5	82,89	4224458M1	75-105	82,89	521451M1	625-1	173,174	570039M1	144-1	142,151,153
4223920M91	72-30	83	4224460M91	130-71	133,136	522063M1	144-269	145	570062M3	984-1	93
4223921M91	71-5	82,89	4224475M91	130-198	133,135	522078M1	153-233	157,165	570063M3	984-1	93
4223922M91	71-5	82,89	4224476M91	72-106	86	523092M91	570-1	367	57073	141-32	132,140
4223923M91	71-5	82,89	4224501M1	73-90	84,85,89,90	525743M1	515-2	349	57151	6691-1	93
4223924M1	74-11	83,84,88,90	4224506M91	71-34	85	525832M1	144-259	151	577491M91	574-14	177,186,187
4223925M1	74-32	85,88	4224526M91	71-53	83,88-90	526664M91	200-3	221	577492M91	574-14	177,186,187
4223926M1	74-90	84	4224595M91	72-90	89	526665M91	200-2	218,221	579012M92	6099-8	121
4223929M1	75-105	82,89	4224611M91	72-91	86	526666M91	200-1	218,219,230	58012	71-3	82,89

Les références des pièces sont indicatives.
Nos pièces ne sont pas d'origine

Part numbers are quoted for reference purposes only.
Our parts and accessories are not original.



"THE RELIABLE SERVICE"



REFERENCES INTERCHANGEABLES
CROSS REFERENCES

OEM OEM	Réf. Ref.	Page Page	OEM OEM	Réf. Ref.	Page Page	OEM OEM	Réf. Ref.	Page Page	OEM OEM	Réf. Ref.	Page Page
58013	72-5	82,89	646102M2	730-1	393	68238	34-78	45,47,49,50,54,58	731155M1	46-1	70,71,75,76
58293	131-2	131,138	646104M2	730-2	393	68241	71-31	84,90	731164M1	74-6	83,90
58305	131-2	131,138	646104M91	729-2	392	68246	71-59	85,88	731174M1	142-2	132,138,140
58703	2-1	11,18	646110M1	461-1	323	68248	71-10	83,84,88,90	731192M1	16-1	32-36,38-40
58703A	2-1A	11,18	646663M91	902-1	373	68249	71-10	83,84,88,90	731203M1	81-1	94,102
58703B	2-1B	11,18	646669M1	903-1	373	68250	71-10	83,84,88,90	731204M1	83-3	94,102
58703C	2-1C	11,18	646670M91	901-1	373	68251	71-10	83,84,88,90	731205M2	82-1	94,102
58703D	2-1D	11,18	68006	72-10	83,84,89,90	68258	71-59	85,88	731214M1	6079-1	99
58762	3-19	12	68009	72-10	83,84,89,90	68267	71-3	82,89	731228M1	12-10	20,28
588237M1	372-4	291,292	6801022	117-42	126,127	68281	71-12	85,88	731236M1	84-5	108,111
588238M1	372-4	291,292	6801027	117-37	126,128	68286	71-34	85	731256M1	141-3	131,138,140
58923	41-1	62,69	6801029	117-36	126,128	68288	71-34	85	731267M1	65-1	168
59093	131-11	136	6801052	117-167	128	68301	33-69	45,49,50,52,53,56	731268M1	66-1	168
59094	131-11	136	6801058	117-135	126,128	68306	33-5	43,44,51,56	731273M1	74-5	82,89
59101	131-10	136	6801088	117-151	126,128	68332	33-7	44,51,53,56	731354M1	22-32	31
59140	131-4	132,138	6801093	117-150	127	68391	33-78	47,50,54,56	731356M1	21-17	31
59155	33-4	43,44,51,53,56	68011	72-10	83,84,89,90	68393	33-77	47,50,54,56	731395M1	59-1	399,406
59156	32-4	43,44,51	6801104	117-156	127	68498	34-78	45,47,49,50,54,58	731463M1	28-8	34,38,40
59537	14-3	22,24,26,27,29	6801106	117-158	127	68501	34-7	43,44,51,53,58	731567M1	113-1	129
59581	42-4	61,62,68,69,77	68013	72-10	83,84,89,90	68502	32-5	43,44,51	731595M1	36-3	43,44,53,57
59582	31-6	44,51	68016	72-6	83,90	68503	32-4	43,44,51	731628M91	82-3	95,103
59583	31-6	44,51	68032	72-10	83,84,89,90	68504	32-7	43,44,51	731635M91	91-2	108,111
59585M1	144-6	143,144,151,153	68036	72-9	83,90	68506	32-12	45,49,55	731752M91	75-4	82,89
59596	71-30	83	68053	1-2	12,18	68506C	32-12C	55	731774M91	131-2	131,138
59617	2-2	12,18	68055	1-32	15,17	68508	32-13	46,49	731988M1	15-5	34,35,38,40
59617A	2-2A	12,18	68076	1-32	15,17	68509	32-22	47,50,55	731999M1	21-22	31
59617B	2-2B	12,18	68077	1-29	15,17	68509C	32-22C	55	732043M1	11-12	21
59617C	2-2C	12,18	68078	2-4	15,17	68510	32-18	47,55	732102M1	43-15	62,77
59617D	2-2D	12,18	68078A	2-4A	15,17	68510C	32-18C	55	732117M1	74-7	83
59618	32-6	44,51	68078B	2-4B	15,17	68512	32-24	47	732443M1	142-1	131,138,140
59619	33-7	44,51,53,56	68078C	2-4C	15,17	68514	32-9	45,49,51	732445M1	41-3	61,62,68,69
59626	71-8	83,90	68079	2-29	15,17	68515	32-10	45,51	732591M91	131-4	132,138
59627	72-9	83,90	68079A	2-29A	15,17	68516	32-69	45,49,50,52	732630M91	2-1	11,18
59629	3-1	11,18	68079B	2-29B	15,17	68517	32-16	44	732631M91	2-1A	11,18
59630	3-1A	11,18	68079C	2-29C	15,17	68572	131-49	134,137	732632M91	2-1B	11,18
59631	3-1B	11,18	68081	2-29	15,17	68575	131-32	134	732633M91	2-1C	11,18
59632	34-4	43,44,51,58	68081A	2-29A	15,17	68576	131-49	134,137	732638M1	35-4	43,44,51,57
59633	34-4	43,44,51,58	68081B	2-29B	15,17	68584	131-49	134,137	732811M1	42-4	61,62,68,69,77
59634	32-4	43,44,51	68081C	2-29C	15,17	68586	130-14	133,139	732821M1	74-9	83,90
59636	31-4	43,44,51	68082	2-2	12,18	68587	130-14	133,139	732921M2	41-9	62
59637	31-4	43,44,51	68082A	2-2A	12,18	68609	1-8	13,17,18	733507M1	80-1	94,102
59638	31-4	43,44,51	68082B	2-2B	12,18	68803	33-78	47,50,54,56	733551M92	91-1	108,111
59652	131-4	132,138	68082C	2-2C	12,18	68810	33-59	46,56	733705M1	21-50	31
59908	25-1	32,33,39,40	68082D	2-2D	12,18	68859	111-1	173,187	733733M1	84-10	98,100
60410174	982-1	93	68082E	2-2E	12,18	69003	71-35	85,88	733757M1	12-4	24,27
60582	141-1	132,140	68082F	2-2F	12,18	69005	71-35	85,88	733767M1	28-2	33-36,38-40
60600024	939-8	422	68083	2-1	11,18	69006	71-35	85,88	733770M1	123-1	105
60600050	939-13	422	68083A	2-1A	11,18	69027	71-31	84,90	733817M1	53-2	78,79,80,81
60600066	939-12	422	68083B	2-1B	11,18	69028	71-59	85,88	733820M1	47-2	73,74
60600341	939-3	422	68083C	2-1C	11,18	69029	71-59	85,88	733822M1	44-4	71,72,73,74,75,76
60600342	939-5	422	68083D	2-1D	11,18	69035	71-6	83	733823M1	45-4	71,72,73,74,75,76
60600780	923-2	410	68084	2-1	11,18	69036	71-7	83,90	733834M1	74-15	85,88
60600849	933-3	423	68084A	2-1A	11,18	69038	71-3	82,89	733887M1	122-1	105
6100645M1	144-261	151,153	68084B	2-1B	11,18	69048	71-31	84,90	734106M1	42-15	62,77
6102366M1	144-274	151,153	68084C	2-1C	11,18	69097	72-5	82,89	734127M1	35-16	44,57
6106495M91	920-115	408	68084D	2-1D	11,18	69812	34-23	47,50,58	734175M1	35-7	43,44,51,57
61153	73-1	83	68084E	2-1E	11,18	701114M1	462-3	323,334	734179M1	36-7	43,44,51,53,55,57
613758M2	151-1	155	68084F	2-1F	11,18	70230008	46-2	71,72,73,74,75,76	734260M1	73-8	83,90
61396	74-2	83	68085	2-11	13,17,18	70275297	908-4	373	734460M91	33-4	43,44,51,53,56
61471	6691-4	93	68085A	2-11A	13,17,18	70275298	908-3	373	734466M91	33-7	44,51,53,56
61800	79-1	93	68085B	2-11B	13,17,18	70923936	306-1	275,276	734467M91	33-7	44,51,53,56
619413M91	1918-64	212	68085C	2-11C	13,17,18	7111/296	111-5	130,173-188	734637M1	12-16	23,26
621234M1	1955-239	212,214	68109	40-6	62,66,67,69	7111/403	112-1	130	734644M1	36-18	49,50,54,57
621235M1	1955-382	212,215	68112	40-6	62,66,67,69	7111/429	112-2	130	734664M1	17-1	20,21,28,29
623139M1	454-7	322	68113	40-6	62,66,67,69	7111/796	111-6	176-181,186-188	734723M91	126-2	129
6232A	930-10	411-414,416,420	68115	40-6	62,66,67,69	7111/44	111-2	173	734738M1	82-4	95-97,100,102-104
6232A	930-4	411-414,416,420	68116	40-6	62,66,67,69	7126	154-113	155,166	734738M91	82-4	95-97,100,102-104
6232A	930-87	411-414,416,420	68120	40-6	62,66,67,69	7176/496	111-63	178-180,185,186	734749M1	12-3	22,23,26,28-30
6232A	930-90	411-414,416,420	68128	40-3	61,68	731003M2	59-1	399,406	734849M1	94-5	112,113
629004M1	144-262	142	68131	40-1	61,68	731008M1	15-1	32-34,38-40	734850M1	94-3	112,113
636208M1	144-1	142,151,153	68135	40-4	62,69	731011M2	73-7	83,90	734874M1	65-2	168
636762M1	57-1	200	68136	40-4	62,69	731028M1	81-2	95,103	734883M1	56-1	95-104
640010M1	164-1	169	68184	40-5	62,69	731033M1	84-8	95-104	734905M2	99-1	112,113
641696M1	144-263	142	68211	72-31	84,90	731034M1	82-2	95,103	734962M91	85-2	106
643081M91	111-1	173,187	68218	72-57	85,88	731087M1	28-1	32,33,39,40	735016M1	66-2	168
645695M91	463-24	334	68219	72-57	85,88	731117M91	86-1	107	735018M2	73-4A	82,89
645930M2	791-1	389	68221	72-57	85,88	731126M1	41-3	61,62,68,69	735057M1	74-8	82,89
645931M1	791-2	389	68222	72-57	85,88	731150M1	54-2	78,81	735099M91	127-5	129
646059M1	453-1	322	68225	72-57	85,88	731151M1	42-3	61,62,68,69,77	735100M91	127-6	129
646060M1	452-1	322	68226	72-57	85,88	731152M1	43-3	61,62,68,69,77	735101M91	127-7	129
646099M91	729-1	392	68227	72-57	85,88	731153M1	44-3	70,71,75,76	735102M91	127-8	129
646101M2	730-1	393	68231	72-57	85,88	731154M1	45-3	70,71,75,76	735110M1	17-3	22,24,26,27,29

Les références des pièces sont indicatives.
Nos pièces ne sont pas d'origine

Part numbers are quoted for reference purposes only.
Our parts and accessories are not original.



"THE RELIABLE SERVICE"



**REFERENCES INTERCHANGEABLES
CROSS REFERENCES**

OEM OEM	Réf. Ref.	Page Page	OEM OEM	Réf. Ref.	Page Page	OEM OEM	Réf. Ref.	Page Page	OEM OEM	Réf. Ref.	Page Page
735112M1	4-1	19	737066M91	3-2	12,18	742466M1	35-15	46,49,50,52,57	745778M91	34-12C	55
735113M1	5-1	19	737067M91	3-2A	12,18	742513M91	3-29	15,17	745786M91	34-12C	55
735118M91	90-3	108,110,111	737068M91	3-2B	12,18	742587M91	3-29A	15,17	745815M91	34-11C	43,51,58
735127M1	17-15	23,26	737069M91	3-2C	12,18	742588M91	3-29B	15,17	745818M91	34-7	43,44,51,53,58
735129M91	86-2	107	737070M91	3-1	11,18	742589M91	3-29C	15,17	745819M91	34-4	43,44,51,58
735168M91	2-3	12-14,17,18	737071M91	3-1A	11,18	742621M91	33-8	43,44,51,53,56	745820M91	34-4	43,44,51,58
735169M91	2-3A	12-14,17,18	737072M91	3-1B	11,18	742681M91	1-8	13,17,18	745823M91	34-3	43,44,53,58
735170M91	2-3B	12-14,17,18	737073M91	3-1C	11,18	742742M91	1-2	12,18	745826M91	34-8	43,44,51,53,58
735171M91	2-3C	12-14,17,18	737095M91	131-6	132,136	742806M91	40-6	62,66,67,69	745832M91	34-3	43,44,53,58
735187M91	33-12	45,49,55,56	737163M1	142-3	133,140	742827M91	1-5	11,18	745902M91	34-16	44,58
735227M1	51-11	55	737214M1	36-13	46,49,50,57	742993M1	73-3	82,89	745905M91	34-21	46,52,58
735231M91	71-5	82,89	737239M91	2-10	12	743020M1	94-2	112,113	745952M91	34-20	49,58
735306M91	127-2	129	737240M91	2-10A	12	743029M91	72-6	83,90	745987M91	72-9	83,90
735349M91	71-8	83,90	737241M91	2-10B	12	743064M91	130-8	132,136,137,139	745990M1	36-21	46,52,57
735350M92	72-9	83,90	737242M91	2-10C	12	743110M91	33-69	45,49,50,52,53,56	745991M1	35-21	46,52,57
735521M1	45-4	71,72,73,74,75,76	737309M91	1-2	12,18	743115M1	93-2	112,113	746008M1	43-5	61,62,68,77
735525M1	44-4	71,72,73,74,75,76	737640M1	43-4	61,68,69,77	743121M91	33-5	43,44,51,56	746036M1	74-13	84,90
735599M1	12-10	20,28	737964M92	90-12	108,110	743137M1	93-1	112,113	746050M91	71-6	83
735707M91	71-3	82,89	738094M1	41-8	63,66,69	743602M91	127-1	129	746051M91	71-7	83,90
735726M91	71-6	83	738095M1	42-16	63,66,69,77	743603M91	127-2	129	746156M91	2-1	11,18
735742M1	4-4	19	738106M91	33-21	46,52,56	743604M91	127-3	129	746157M91	2-1A	11,18
735743M1	5-4	19	738249M91	33-9	45,49,51,53,56	743685M91	71-35	85,88	746158M91	2-1B	11,18
735761M91	127-7	129	738287M91	33-11	43,51,56	743789M91	72-31	84,90	746159M91	2-1C	11,18
735800M1	4-2	19	738339M1	28-3	33	743824M91	33-7	44,51,53,56	746163M91	34-59	46,58
735801M1	5-2	19	738368M91	33-23	47,50,56	743924M91	121-1	105	746251M91	33-59	46,56
735820M1	42-9	62,64,66,67,69,77	738588M1	15-14	35,38,39	744131M1	36-14	45,47,49-54,57	746259M1	22-38	31
735826M1	65-5	168	738797M91	72-5	82,89	744210M91	2-4A	15,17	746288M91	71-31	84,90
735852M1	83-1	95-100,102-104	738871M91	33-18	47,50,54-56	744211M91	2-4B	15,17	746342M1	73-11	83,84,88,90
735865M1	21-32	31	738872M91	33-18C	55	744212M91	2-4C	15,17	746382M91	1-8	13,17,18
735866M1	13-1	20,21,28,29	738890M91	127-8	129	744228M91	130-32	134	746432M91	90-6	112,113
735869M1	21-38	31	738944M1	43-16	63,66,69,77	744243M1	120-2	105	746694M1	94-6	112,113
735876M91	71-30	83	739013M91	131-8	132-139	744314M91	130-8	134	746696M1	89-4	112,113
735934M1	13-5	21	739027M1	42-6	62,66,67,69,77	744381M1	74-32	85,88	746697M1	89-3	112,113
735942M1	13-2	22-24,26,27,29	739043M1	35-7	43,44,51,57	744391M1	73-8	83,90	746714M1	74-11	83,84,88-90
735944M1	22-35	31	739060M1	42-5	61,62,68,77	744512M91	127-5	129	746774M91	40-6	62,66,67,69
736012M91	90-5	109,110	739254M91	131-13	133,139	744513M91	127-6	129	746792M91	31-59	46
736206M1	65-7	168	739400M91	90-4	110	744514M91	127-7	129	746804M91	72-12	85,88
736240M1	17-2	21,29	739439M1	43-27	61,68,77	744515M91	127-8	129	746823M1	42-25	62,66,67,69,77
736254M1	81-3	95-104	739641M1	42-27	61,68,77	744539M1	73-56	85,88	746835M1	146-3	141,152
736297M1	41-17	62,63,64,66,67,69	739643M1	35-21	46,52,57	744620M91	6121-1	105	746954M1	94-11	114,115
736336M91	2-2	12,18	739791M1	74-17	85,88	74468	940-36	421	747041M91	34-13	46,49,53,58
736337M91	2-2A	12,18	739845M91	33-3	43,44,53,56	74468	940-4	421	747050M91	33-57	46,49,52,53,56
736338M91	2-2B	12,18	739901M1	73-30	83	74469	940-36	421	747063M1	73-4	82,89
736339M91	2-2C	12,18	739972M1	43-5	61,62,68,77	74469	940-4	421	747128M1	4-3	19
736386M91	25-2	32,33,39,40	740082M91	33-10	45,51,56	744723M1	73-12	85,88	747129M1	5-3	19
736416M91	72-10	83,84,89,90	740221M1	65-3	168	744755M91	71-10	83,84,88,90	747166M91	71-3	82,89
736453M1	46-2	71,72,73,74,75,76	740235M91	14-1	20,21,28,29	744921M91	2-29	15,17	747169M91	71-10	83,84,88,90
736507M3	35-14	45,47,49-52,57	740376M1	73-35	85,88	744922M91	2-29A	15,17	747169M92	71-10	83,84,88,90
736513M91	90-1	108,111	740377M1	73-12	85,88	744923M91	2-29B	15,17	747171M91	71-59	85,88
736532M91	1-1	11,18	740407M1	28-1	32,33,39,40	744924M91	2-29C	15,17	747172M91	71-59	85,88
736612M1	6093-1	105	740465M1	44-67	71,72,73,74,75,76	744948M1	35-14	45,47,49-52,57	747175M91	71-12	85,88
736714M91	14-1	20,21,28,29	740467M1	45-61	71,72,73,74,75,76	744971M1	28-16	33-36,38-40	747180M91	71-35	85,88
736754M1	66-3	168	740535M91	34-13	46,49,53,58	745243M1	36-7A	55	747185M91	72-5	82,89
736812M1	42-6A	77	740571M1	36-15	46,49,50,52,53,57	745277M91	34-78	45,47,49,50,54,58	747186M91	72-5	82,89
736813M1	42-6B	77	740607M91	131-2	131,138	745369M1	43-26	63,64,66,67,69,77	747187M91	72-5	82,89
736814M1	42-6C	77	740647M91	131-2	131,138	745379M91	33-78	47,50,54,56	747191M91	72-10	83,84,89,90
736818M1	80-4	95-104	740671M1	54-3	78,79,80,81	745405M91	2-2	12,18	747195M91	72-12	85,88
736829M91	1-4	12,17	740684M91	296-10	232	745406M91	2-2A	12,18	747196M91	72-57	85,88
736878M91	3-11	13,17,18	740821M91	33-13	46,49,53,56	745407M91	2-2B	12,18	747197M91	72-57	85,88
736879M91	3-11A	13,17,18	740828M1	17-5	22-30	745408M91	2-2C	12,18	747198M91	72-57	85,88
736880M91	3-11B	13,17,18	740865M91	82-15	95,103	745462M1	74-32	85,88	747199M91	72-12	85,88
736881M91	3-11C	13,17,18	741138M1	15-7	35-37	745491M1	73-56	85,88	747292M91	90-14	109,110
736892M1	42-9A	77	741262M1	83-2	98,100	745533M1	41-20	61,62,68	747293M91	90-23	109,110
736893M1	42-9B	77	741263M91	82-11	98,101	745534M1	42-24	61,68,77	747428M91	34-57	46,49,52,53,58
736894M1	42-9C	77	741265M1	84-9	98,100	745584M91	2-11	13,17,18	747444M91	131-8	132,133,136-139
736915M91	3-10	12	741266M91	82-10	98,101	745585M91	2-11A	13,17,18	747446M91	130-13	133
736916M91	3-10A	12	741335M91	33-16	44,56	745586M91	2-11B	13,17,18	747447M91	71-59	85,88
736917M91	3-10B	12	741378M1	17-4	20,21,28,29	745587M91	2-11C	13,17,18	747448M91	71-59	85,88
736918M91	3-10C	12	741466M1	43-6	62,66,67,69,77	745661M91	34-7	43,44,51,53,58	747476M91	86-5	107
736930M91	2-4	15,17	741614M1	98-2	192	745730M1	73-31	84,90	747541M91	33-77	47,50,54,56
736931M91	2-4A	15,17	741657M91	131-4	132,138	745738M91	34-75	47,50,54,58	747542M91	130-6	131,138
736932M91	2-4B	15,17	741668M1	17-9	23,30	745746M91	34-12	45-58	747552M1	43-9	62,64,66,67,69,77
736933M91	2-4C	15,17	741764M1	65-6	168	745747M91	34-12	45-58	747553M1	43-9A	77
736934M91	3-4	15,17	741881M91	131-2	131,138	745747M91	34-12T	47,58	747554M1	43-9B	77
736935M91	3-4A	15,17	741922M1	98-1	192	745750M91	34-18	47,55,58	747555M1	43-9C	77
736936M91	3-4B	15,17	741937M1	43-6A	77	745751M91	34-23	47,50,58	747570M91	130-49	134,137
736937M91	3-4C	15,17	741938M1	43-6B	77	745752M91	34-24	47,54,55,58	747581M1	43-5	61,62,68,77
736950M91	3-3	12-14,17,18	741939M1	43-6C	77	745758M91	34-13	46,49,53,58	747597M91	130-4	132,138
736951M91	3-3A	12-14,17,18	741951M91	72-30	83	745760M91	34-12	45-58	747602M91	34-74	45,49,50,52,53,58
736952M91	3-3B	12-14,17,18	742106M91	296-10	232	745763M91	34-9	45,49,51,53,58	747606M1	17-3	22,24,26,27,29
736953M91	3-3C	12-14,17,18	742207M1	89-1	112,113	745764M91	34-10	45,51,58	747611M91	130-48	134
737020M1	41-19	61,68	742208M1	89-2	112,113	745777M91	34-12C	55	747650M91	130-14	133,139

Les références des pièces sont indicatives.
Nos pièces ne sont pas d'origine

Part numbers are quoted for reference purposes only.
Our parts and accessories are not original.



REFERENCES INTERCHANGEABLES
CROSS REFERENCES

OEM OEM	Réf. Ref.	Page Page	OEM OEM	Réf. Ref.	Page Page	OEM OEM	Réf. Ref.	Page Page	OEM OEM	Réf. Ref.	Page Page
747694M1	15-16	35,36	76490	940-5	421	77121	940-12	421	825840M1	2-18	12
747764M91	131-10	136	76498	940-5	421	77129	940-14	421	825843M91	130-1	132,138
747771M91	131-32	134	76538	940-5	421	77131	940-12	421	825861M1	35-41	44,57
747813M1	44-4	71,72,73,74,75,76	76712	940-5	421	77132	940-12	421	825890M91	6689-1	93
747814M1	45-4	71,72,73,74,75,76	76715	940-4	421	77133	940-12	421	825982M1	2-18B	12
747891M91	131-49	134,137	76715	940-36	421	77135	940-14	421	826023M13	2-20	18
747936M91	141-3	131,138,140	76722	940-4	421	77139	940-12	421	826046M2	13-13	21,29
747939M91	142-1	131,138,140	76722	940-36	421	77141	940-12	421	826049M1	15-15	33,40
747941M91	142-2	132,138,140	76727	940-5	421	77143	940-12	421	826059M91	92-10	111
747942M91	141-64	132,138,140	76740	940-9	421	77152	940-14	421	826077M1	3-20	12,18
747943M91	141-65	133,136,140	76753	940-9	421	77157	940-6	421	826094M1	6691-5	93
747944M91	141-11	133,137,139,140	76755	940-6	421	77160	940-6	421	82611	40-4	62,69
747945M91	142-17	133,139,140	76756	940-9	421	772893M91	321-1	280	826119M91	130-1	132,138
747946M91	142-3	133,140	76763	940-6	421	773126M92	570-2	367	82612	40-5	62,69
747947M91	142-31	134,140	76766	940-4	421	782509M91	560-16	379	826127M2	58-1	200
747948M91	142-30	134,140	76766	940-36	421	785625M92	413-24	313	826129M1	43-2	62,69,77
747949M91	141-61	137,140	76767	940-4	421	791265M91	462-2	323,334	826137M91	96-1	173
747950M91	141-60	134,137,140	76767	940-36	421	794927M1	252-2	243,244,265,266	826154M91	100-1	117
747951M91	141-62	137,140	76772	940-4	421	80020	2-11	13,17,18	826162M1	41-2	62,69
747965M91	131-6	132,136	76772	940-36	421	80037	2-4	15,17	826168M1	42-2	62,69,77
748007M91	71-9	82,89	76773	940-4	421	80037A	2-4A	15,17	826169M1	43-2	62,69,77
748008M91	71-5	82,89	76773	940-36	421	80037B	2-4B	15,17	826171M1	45-2	71,76
748072M91	82-16	99	76776	940-4	421	80037C	2-4C	15,17	826194M1	74-4	83,90
748095M91	130-12	132	76776	940-36	421	80121	40-4	62,69	826199M1	141-2	132,138,140
748164M91	131-48	134	76781	940-9	421	80123	40-4	62,69	82620	40-1	61,68
748201M1	12-15	25,28,30	76786	940-6	421	80167	40-5	62,69	826218M1	118-1	129
748215M1	36-108	46-48,50,52,54,57	76794	940-5	421	81210	79-1	93	826244M1	42-20	62,77
748216M1	35-108	46-48,50,52,57	76796	940-6	421	81512	33-4	43,44,51,53,56	826245M1	43-20	62,77
748266M91	33-77	47,50,54,56	76800	940-6	421	81522	33-16	44,56	826246M1	71-20	83
748267M91	33-77	47,50,54,56	76803	940-6	421	81558	2-3	12-14,17,18	826250M1	73-20	83
748277M1	74-11	83,84,88-90	76804	940-6	421	81558A	2-3A	12-14,17,18	826257M1	141-66	132
748285M91	40-4	62,69	76808	940-5	421	81558B	2-3B	12-14,17,18	826276M91	32-41	44
748309M1	43-26	63,64,66,67,69,77	76815	940-6	421	81558C	2-3C	12-14,17,18	826306M1	143-5	142-144,150-153
748329M1	74-91	86	76816	940-6	421	81558D	2-3D	12-14,17,18	826410M92	759-3	395
748400M91	40-6	62,66,67,69	76820	940-6	421	81558E	2-3E	12-14,17,18	826477M91	450-1	322
748413M1	42-38	63,64,67,69,77	76821	940-6	421	81558F	2-3F	12-15,17	826751M91	491-1	336,338
748420M1	41-18	62,63,64,66,67,69	76823	940-6	421	81560	32-12	45,49,55	826752M92	492-1	336,338,340
748709M91	131-12	132	76824	940-6	421	81560C	32-12C	55	826756M91	491-1	336,338
748737M91	130-10	136	76825	940-9	421	81565	33-5	43,44,51,56	826768M1	714-4	390
748773M91	40-6	62,66,67,69	76826	940-6	421	81583	34-12	45-55,58	826769M1	714-3	390
762101M1	6284-2	266,267	76827	940-6	421	81583C	34-12C	55	826772M1	151-2	155,164
76407	940-1	421	76833	940-9	421	817630M1	903-2	373	826773M1	55-2	107, 155-164
76411	940-36	421	76834	940-9	421	818017M1	439-1	316	826775M1	154-6	155,166
76411	940-4	421	76835	940-9	421	81874	32-5	43,44,51	826788M1	919-4	410
76415	940-36	421	76836	940-9	421	81879	72-12	85,88	826812M91	840-4	424,426
76415	940-4	421	76837	940-6	421	82111	33-7	44,51,53,56	826815M91	844-2	424
76417	940-36	421	76850	940-6	421	82112	32-7	43,44,51	826816M91	844-1	424
76417	940-4	421	76852	940-6	421	82116	31-5	43,44,51,53	826817M92	843-1	424
76418	940-1	421	76854	940-9	421	82117	31-5	43,44,51,53	826960M1	144-1	142,151,153
76425	940-36	421	76855	940-6	421	82118	34-7	43,44,51,53,58	826963M1	163-24	190
76425	940-4	421	76862	940-9	421	82119	31-7	43,44,51,53	826988M1	154-2	155,166
76426	940-36	421	76864	940-9	421	82120	31-7	43,44,51,53	827055M1	170-1	196
76426	940-4	421	76865	940-9	421	82121	34-7	43,44,51,53,58	827080M1	163-23	190
76443	940-36	421	76869	940-9	421	82136	32-4	43,44,51	827351M91	844-10	425
76443	940-4	421	76881	940-9	421	82137	32-6	44,51	827488M1	74-3	83
76445	940-36	421	76885	940-6	421	82154	34-16	44,58	827496M1	153-2	155,165
76445	940-4	421	76891	940-6	421	82158	33-18	47,50,54-56	827501M91	92-11	111
76449	940-36	421	76892	940-6	421	823326M1	55-5	107	827556M1	35-2	44,51,57
76449	940-4	421	76895	940-6	421	824245M1	164-2	169	827560M91	71-20	83
76453	940-36	421	76896	940-6	421	824332M1	730-2	393	827561M92	71-2	83,90
76453	940-4	421	76897	940-6	421	825003M1	167-1	169	827612M1	73-2	83,90
76458	940-5	421	76899	940-6	421	825064M1	407-1	300	827707M5	400-1	300
76460	940-4	421	76900	940-9	421	825079M91	403-1	300	827719M91	268-1	254
76460	940-36	421	76902	940-6	421	825111M1	6-13	12	827854M1	442-11	315
76464	940-4	421	76908	940-6	421	825112M1	6-13	12	827877M1	167-2	169
76464	940-36	421	76910	940-9	421	825132M1	74-1	83	827930M1	153-6	155,165
76465	940-4	421	76911	940-9	421	825135M1	81-4	93	828033M92	177-3	201
76465	940-36	421	76912	940-9	421	825136M1	12-17	93	828047M1	164-5	169
76466	940-4	421	76913	940-9	421	825157M91	6690-1	93	828085M1	55-5	107
76466	940-36	421	76928	940-9	421	825186M1	45-11	71	828123M2	230-1	218-223,225-231
76468	940-4	421	76956	940-9	421	825199M1	6691-1	93	828139M1	143-3	141-147,150-153
76469	940-4	421	76961	940-6	421	825208M1	13-21	21	828140M1	55-2	155-157,160-164
76470	940-4	421	77006	940-4	421	825259M1	41-1	62,69	828141M1	143-2	142,151,153
76470	940-36	421	77010	940-9	421	825315M1(4x)	3-18	12	828147M1	154-3	155,166
76471	940-4	421	77025	940-9	421	825374M1	131-2B	135	828217M1	442-1	315
76471	940-36	421	77032	940-9	421	825633M91	1562-1	437	828234M91	491-31	337,338
76474	940-5	421	77034	940-6	421	825702M2	151-1	155	828583M91	105-2	122
764805M92	417-1	301	77035	940-6	421	825740M1	11-15	21,29	828597M2	206-1	238,239
76485	940-4	421	77052	940-9	421	825764M91	403-1	300	828695M1	74-3	83
76485	940-36	421	77058	940-6	421	825776M1	342-1	283-284	828724M1	6618-2	380
76486	940-4	421	771130M1	352-19	287	825807M1	96-3	173-177,182-187	828729M1	144-264	142
76486	940-36	421	771150M1	352-19	287	825837M1	2-18A	12	82877	130-10	136

Les références des pièces sont indicatives.
Nos pièces ne sont pas d'origine

Part numbers are quoted for reference purposes only.
Our parts and accessories are not original.



"THE RELIABLE SERVICE"



REFERENCES INTERCHANGEABLES
CROSS REFERENCES

OEM OEM	Réf. Ref.	Page Page	OEM OEM	Réf. Ref.	Page Page	OEM OEM	Réf. Ref.	Page Page	OEM OEM	Réf. Ref.	Page Page
82878	33-12	45,49,55,56	83392A	2-11A	13,17,18	85036E	3-1E	11,18	86957	131-8	132-139
82878C	33-12C	55	83392B	2-11B	13,17,18	85036F	3-1F	11,18	86960	71-35	85,88
82879	32-12	45,49,55	83392C	2-11C	13,17,18	85037	3-10	12	86967	71-10	83,84,88,90
82879C	32-12C	55	83393	71-7	83,90	85037A	3-10A	12	86974	72-5	82,89
82885	72-10	83,84,89,90	83396	72-6	83,90	85037B	3-10B	12	86979	72-10	83,84,89,90
82886	71-5	82,89	83398	71-3	82,89	85037C	3-10C	12	86985	71-31	84,90
82887	72-5	82,89	83400	72-5	82,89	85041	3-11	13,17,18	86994	72-30	83
82889	71-12	85,88	834216M1	305-7	276,278	85041A	3-11A	13,17,18	8778	221-227	218
82890	71-10	83,84,88,90	834217M1	6412-2	357	85041B	3-11B	13,17,18	880008M92	495-1	336,338
82891	131-6	132,136	834218M1	304-2	276,278	85041C	3-11C	13,17,18	880009M92	495-2	336,338
828927M92	620-1	374	834219M1	376-3	291,292	85042	3-3	12-14,17,18	880010M92	495-7	336,338
828993M1	536-2	351	834229M1	376-3	291,292	85042A	3-3A	12-14,17,18	880011M92	495-6	336,338
829029M1	74-1	83	83424	34-18	47,55,58	85042B	3-3B	12-14,17,18	880012M93	495-3	337,338
829058M91	403-1	300	83424C	34-18C	55	85042C	3-3C	12-14,17,18	880031M91	158-6	191
829059M91	403-1	300	834291M1	261-3	269	85042D	3-3D	12-14,17,18	880051M91	303-90	275
82906	34-4	43,44,51,58	834303M1	252-2	243,244,265,266	85042E	3-3E	12-14,17,18	880069M2	330-1	281
82907	71-8	83,90	834343M1	618-1	375-378	85042F	3-3F	12-14,17,18	880070M2	330-2	281
82908	72-9	83,90	83437	2-2	12,18	85043	3-4	15,17	880227M1	838-4	424
829121M1	1920-8	215	83437A	2-2A	12,18	85043A	3-4A	15,17	880256M93	844-28	424
829258M1	578-1	370	83437B	2-2B	12,18	85043B	3-4B	15,17	880257M93	844-29	424
829259M1	578-2	370	83437C	2-2C	12,18	85043C	3-4C	15,17	880271M1	161-3	175,188
829458M92	502-1	346	83437D	2-2D	12,18	85043D	3-4D	15,17	880284M1	452-1	322
829485M91	175-1	198	83451	72-9	83,90	85043E	3-4E	15,17	880291M91	471-7	326
829486M91	176-1	198	834602M1	231-16	218-223,225-231	85043F	3-4F	15,17	880292M91	470-7	326
829487M91	177-1	201	834602M1	231-1	218-223,225-231	85064	79-1	93	880406M91	177-6	201
829489M91	58-1	200	834733M1	353-20	286,287	8521	759-1	395	880468M1	171-1	197
829612M1	34-2	44,51,58	834844M1	264-4	249,250	85718	72-12	85,88	880494M94	471-7	326
829613M1	34-2	44,51,58	835568M92	96-2	173-175,182	8572	221-226	218	880495M94	470-7	326
829731M91	33-2	44,51,58	835939M91	414-1	311	85730	34-9	45,49,51,53,58	880678M91	165-2	170
829732M1	34-2	44,51,58	836218M91	111-3	130,173-188	85744	34-13	46,49,53,58	880951M91	529-1	350
829924M1	982-1	93	836218M91	111-5	130,173-188	85753	32-23	47,50	880955M2	265-2	252
829927M1	980-1	93	837595M91	96-2	173-175,182	85780	71-10	83,84,88,90	880957M1	263-2	252,253
839937M1	983-1	93	840916M92	421-1	301	85781	72-10	83,84,89,90	881021M93	358-1	286
829958M1	940-36	421	843886M1	376-7	293	85795	72-10	83,84,89,90	881122M2	6283-6	268
829958M1	940-4	421	84402	1-1	11,18	85800	131-6	132,136	881144M1	557-1	270,271
830735M91	284-1	263,264	84422	1-4	12,17	85802	131-8	132-139	881162M2	441-3	314,316
830862M91	130-1	132,138	84440	1-2	12,18	85811	1-2	12,18	881303M92	100-7	117,118,120
830889M91	31-2	44,50	844422M1	242-1	269	85821	1-4	12,17	881304M91	97-2	175-188
830895M91	131-1	132,138	847264M92	165-2	170	85847	72-9	83,90	881384M1	451-2	322
830897M91	2-20	18	847416M1	440-12	314	85848	71-10	83,84,88,90	881396M91	174-1	196
830898M91	2-20A	18	847417M1	441-12	314	86151	131-8	132-139	881662M94	729-1	392
830899M91	3-20	12,18	847451M91	492-2	336,338-342	86520	40-4	62,69	881664M94	729-2	392
830900M91	3-20A	12,18	84774	25-2	32,33,39,40	86521	40-5	62,69	881670M1	956-1	203
830901M91	3-20B	12,18	847844M91	844-28	424	86550	40-3	61,68	881727M1+		
830947M91	3-20C	12,18	847845M91	844-29	424	86553	40-1	61,68	881728M1+		
830972M92	31-2	44,50	847848M91	842-3	424,426	86566	40-6	62,66,67,69	881729M1+		
830979M93	337-1	269	847854M1	182-2	211	86584	40-6	62,66,67,69	188909M1+		
831054M1	463-2	323,334	847891M93	432-1	306	86588	40-6	62,66,67,69	375108X1+		
831055M1	463-2	323,334	848187M1	485-14	331,332	86589	40-6	62,66,67,69	3534030X1	579-1	370
831077M1	462-2	323,334	84863	79-1	93	86608	40-6	62,66,67,69	881736M92	495-8	336,338-340
831078M1	462-2	323,334	84920	25-3	33-36,38-40	86609	40-3	61,68	881741M92	498-4	337-339
831187M1	277-1	261,262,265	84955	34-3	43,44,53,58	86704	33-18	47,50,54-56	881881M91	495-7	336,338
831263M1+			84956	34-4	43,44,51,58	86716	33-21	46,52,56	881882M91	495-6	336,338
183630M1 (2x)	765-4	396	84957	34-7	43,44,51,53,58	86721	33-9	45,49,51,53,56	881883M91	495-2	336,338
831343M1	372-24	291,292,293	84966	34-3	43,44,53,58	86723	33-11	43,51,56	881884M91	495-1	336,338
831420M1	446-3	319	84969	34-20	49,58	86726	33-23	47,50,56	881888M92	497-3	337,338
831469M1	261-1	245,249,250,265	84992	2-10	12	86734	34-13	46,49,53,58	881889M1	498-3	336,338
831482M1	376-2	291	84992A	2-10A	12	86740	33-18	47,50,54-56	881932M93	200-3	221
831485M1	339-1	283-284	84992B	2-10B	12	86740C	33-18C	55	881933M1	201-1	238
831513M1	704-2	389	84992C	2-10C	12	86745	33-24	47,54,56	881934M1	211-2	238
83156	79-1	93	85000	72-5	82,89	86753	34-9	45,49,51,53,58	881991M1	376-2	291
831581M2	6284-6	268	85007	72-10	83,84,89,90	86754	34-21	46,52,58	882021M91	177-6	201
83176	40-3	61,68	85009	131-6	132,136	86763	34-24	47,54,55,58	882026M91	177-6	201
831888M1	354-1	286,287,361	85010	2-4	15,17	86773	34-23	47,50,58	882256M92	471-23	334
832519M1	266-1	252,253,261-68	85010A	2-4A	15,17	86775	34-10	45,51,58	882257M92	470-23	334
832544M2	261-3	269	85010B	2-4B	15,17	86778	34-13	46,49,53,58	882261M1	461-24	334
832953M4	230-1	218-223,225-231	85010C	2-4C	15,17	86780	34-13	46,49,53,58	882262M1	476-15	327,328,334
832954M3	358-1	286	85010D	2-4D	15,17	86781	34-8	43,44,51,53,58	882263M1	452-2	322
832960M3	230-1	218-223,225-231	85010E	2-4E	15,17	86785	34-12	45-55,58	882327M1	477-18	327,328,334
832961M1	479-18	334	85010F	2-4F	15,17	86785C	34-12C	55	882539M91	177-4	201
833084M1	231-16	218-223,225-231	850127M1	463-1	323	86821	2-29	15,17	882545M91	177-4	201
833084M1	231-1	218-223,225-231	85035	3-2	12,18	86821A	2-29A	15,17	882554M91	462-24	334
833194M1	266-1	252,253,261-68	85035A	3-2A	12,18	86821B	2-29B	15,17	882572M1	446-12	320
833355M1	461-4	323	85035B	3-2B	12,18	86821C	2-29C	15,17	882636M91	454-3	322
833639M1	372-24	291,292,293	85035C	3-2C	12,18	86832	130-10	136	882637M1	454-3	322
83372	71-6	83	85035D	3-2D	12,18	86865	72-31	84,90	882697M91	712-2	391
83373	72-6	83,90	85035F	3-2F	12,18	86871	72-12	85,88	882698M92	712-2	391
83381	71-30	83	85036	3-1	11,18	86909	72-12	85,88	882905M1	861-4	427
83382	72-30	83	85036A	3-1A	11,18	86934	40-3	61,68	882967M1	372-3	291,292
83388	34-12	45-55,58	85036B	3-1B	11,18	86940	33-13	46,49,53,56	883013M91	31-40	44
83388C	34-12C	55	85036C	3-1C	11,18	86948	131-13	133,139	883015M91	31-1	44
83392	2-11	13,17,18	85036D	3-1D	11,18	86955	131-10	136	883258M91	117-38	128

Les références des pièces sont indicatives.
Nos pièces ne sont pas d'origine

Part numbers are quoted for reference purposes only.
Our parts and accessories are not original.



"THE RELIABLE SERVICE"



REFERENCES INTERCHANGEABLES
CROSS REFERENCES

OEM OEM	Réf. Ref.	Page Page	OEM OEM	Réf. Ref.	Page Page	OEM OEM	Réf. Ref.	Page Page	OEM OEM	Réf. Ref.	Page Page
883389M2	865-1	427	886451M94	712-11	391	89025	131-2	131,138	893007M1	35-40	44,57
883402M92	620-2	374	886549M2	333-2	282	890258M1	163-2	190	893017M2	440-3	314
883569M94	471-24	326,327	886632M1	215-5	238,239	89029	131-12	132	893096M92	470-3	325
883570M94	470-24	326,327	886668M1	251-1	243,244,265,266	89030	131-12	132	893097M92	471-3	325
883621M1	306-2	255-260,276	886682M97	600-3	374	890302M91	221-1	218,219,221,230	893098M92	470-2	325
883622M1	106-2	121	886727M4	232-2	239	890302M91	221-1L	218,219,221,230	893099M92	471-2	325
883623M1	106-2	121	886797M91	497-5	337-340	890322M92	109-1	130	893121M2	203-1	238
883680M1	163-12	190	886801M91	498-4	337-339	89034	131-8	132-139	893159M91	100-17	117
883685M1	163-7	190	886802M91	498-5	336,338-340	89036	131-10	136	893226M91	169-15	191
883686M1	163-8	190	886821M94	626-3	379	890420M91	177-2	201	893373M91	463-3	323,334
883712M94	109-2	130	886851M91	674-2	384	890421M92	175-3	198	893374M91	462-3	323,334
883786M91	110-301	130	886997M91	1931-17	216	890422M92	176-3	198	893375M91	462-3	323,334
883788M91	661-2	383	887057M2	930-90	411-414,416,420	890460M91	177-3	201	893405M3	762-4	397
883797M91	700-34	388	887057M2	930-10	411-414,416,420	890476M93	165-6	170	893419M1	710-2	389
883797M91	700-7	388	887057M2	930-4	411-414,416,420	890543M1	375-3	290	893420M1	730-3	393
883914M94	158-5	191	887057M2	930-87	411-414,416,420	89064	3-29	15,17	893427M93	712-7	391
883928M91	950-1	203	887128M92	268-3	254	890640M1	371-19	290	893428M93	712-7	391
883930M1	951-2	203	887135M1	446-2	319	89064A	3-29A	15,17	893430M93	712-9	391
883935M4	256-3	249,250,251,266	887183M91	6500-17	370	89064B	3-29B	15,17	893431M93	712-9	391
884001M92	1912-121	214	887654M2	671-1	384	89064C	3-29C	15,17	893438M91	700-5	388
884093M1	839-6	424	887869M91	200-64	231	89066	2-4	15,17	893439M91	700-39	388
884094M1	839-5	424	887875M91	200-66	222	89066A	2-4A	15,17	893439M91	700-9	388
884114M1	684-2	385	887879M91	200-4	219,220	89066B	2-4B	15,17	893501M1	60-2	116
884545M1	163-10	190	887881M91	200-4	219,220	89066C	2-4C	15,17	893561M1	766-2	396
884701M92	492-2	336,338-342	887884M91	200-6	221,222	89067	2-29	15,17	893562M91	759-7	397
884747M92	620-3	374	887886M91	200-6	221,222	890674M1	762-1	395	893564M1	761-8	397
884747M93	620-3	374	887889M94	221-3	219-228	89067A	2-29A	15,17	893567M1	758-3	394,396
884791M92	372-3	291,292	887890M93	221-62	219-231	89067B	2-29B	15,17	893568M1	758-2	396
884792M2	372-3	291,292	887893M1	220-3	239	89067C	2-29C	15,17	893570M92	760-12	397
884797M91	490-3	337,338,340	887894M1	219-3	239	89079	3-2	12,18	893575M1	144-4	141,142,143,150
884847M93	370-4	291,292	887895M1	201-3	239	89079A	3-2A	12,18	893607M91	492-12	336,338
884850M3	370-4	291,292	887896M1	201-2	239	89079B	3-2B	12,18	894054M91	495-7	336,338
884906M92	625-1	173,174	887897M1	204-2	239	89079C	3-2C	12,18	894060M3	484-2	324
885344M1	151-3	155,164	887898M1	202-2	239	890933M1	3-19	12	894061M1	483-2	324
885363M91	100-3	117,119,120	887899M93	212-17	239	890955M91	100-5	117,119,120	894131M92	200-251	218
885365M91	847-3	436	887900M91	212-4	219-222	890960M1	100-3	117,119,120	894173M91	495-6	336,338
885408M91	690-5	386	887901M91	212-4	219-222	890982M1	144-3	141,142,151-153	894208M91	735-5	392
885409M91	690-4	386	887902M1	214-2	239	891035M1	6691-4	93	894224M1	6687-1	122
885411M93	150-9	155,164	887903M1	211-3	239	891386M92	222-1	238	894225M1	6687-2	122
885444M91	682-1	385	887906M1	210-9	239	89141	40-3	61,68	894291M2	165-1	170
885447M91	682-4	385	887907M1	217-2	239	89150	1-1	11,18	894291M2	165-1S	170
885448M91	682-4	385	887909M1	215-5	238	891826M1	206-2	238,239	894302M2	351-1	285
885517M1	349-5	285	887910M1	203-2	239	891827M1	207-2	238,239	894319M92	150-3	155
885518M5	349-5	285	888114M1	684-2	385	891904M1	263-2	252,253	894357M92	150-2	155
885520M1	347-2	285	888300M92	469-1	324	891947M1	343-1	283-284	894376M91	700-37	388
885549M91	490-5	337,338	888304M92	468-1	324	891969M91	61-3	116	894376M91	700-4	388
885563M1	154-10	155-157,166	888307M91	491-2	336,338,340	891983M95	200-2	218,221	894377M91	700-38	388
885564M1	153-9	155-157,164,165	888311M1	485-2	330	89205	33-16	44,56	894377M91	700-8	388
885579M93	150-10	155,164	888314M1	486-3	330,331,332	892054M1	9604-113	91	894386M93	712-6	391
885580M3	150-10	155,164	888346M2	930-11	411-420	89206	33-10	45,51,56	894387M93	712-6	391
885599M92	449-16	321	888346M2	930-5	411-420	89207	33-13	46,49,53,56	894388M93	712-8	391
885741T2	449-2	321	888346M2	930-80	411-417,419,420	89209	33-8	43,44,51,53,56	894389M93	712-8	391
885811M1	861-10	427	888358M91	340-4	283	892130M93	109-3	130	894427M91	176-4	198
885856M94	150-4	155,164	888369M91	491-3	336,338,340	89214	33-8	43,44,51,53,56	894429M91	176-4	198
886029M1	686-3A	385	888457M1	331-1	281	89216	33-16	44,56	894431M91	176-32	198
886048M92	696-1	386	888563M91	176-14	199	89228	71-10	83,84,88,90	894432M91	176-32	198
886062M1	100-4	117,120	888564M91	176-11	198	892476M1	704-3	389	894607M1	603-1	375-378
886089M1	249-2	243,244	888607M1	768-1	396	89250	71-10	83,84,88,90	894608M1	604-1	375-378
886100M91	100-6	117,118,120	888628M91	760-5	395	89254	71-10	83,84,88,90	894654M91	498-2	336,338
886336M1	450-2	322	888700M1	607-2	377	892563M1	131-2B	135	894702M1	265-2	252
886337M91	450-2	322	888702M2	605-4	377	89258	71-10	83,84,88,90	894729M1	145-7	154
886348M2	676-3	384	888702M2ASSY	605-4A	377	892604M1	602-1	375	894730M1	145-8	154
886351M1	674-2	384	88881	79-1	93	89261	71-10	83,84,88,90	894737M1	510-2	349
886367M96	650-2	379	888853M1	863-1	427	89262	71-10	83,84,88,90	894738M91	511-2	349
886384M93	200-1	218,219,230	88963	71-10	83,84,88,90	89263	71-10	83,84,88,90	894763M5	371-3S	291,292
886384M93	200-1L	218,219,230	88982	71-10	83,84,88,90	892630M91	100-5	117,119,120	894769M1	380-1	299
886386M93	200-1	218,219,230	88984	71-12	85,88	892632M91	100-9	118,120	894776M1	372-4	291,292
886386M93	200-1L	218,219,230	88986	71-35	85,88	89265	71-10	83,84,88,90	894782M2	376-3	291,292
886388M93	200-2	218,221	890007M2	117-12	126,128	89267	71-10	83,84,88,90	894785M91	150-8	155
886394M93	200-3	221	890021M93	580-1	338,339	892707M92	919-2	410	894793M1	153-8	155,165
886396M1	215-5	238,239	89007	131-48	134	892751M92	844-12	425	894799M1	381-2	299
886399M1	201-1	238	890091M92	712-4	391	892752M92	844-13	425	894808M2	150-8	155
886404M2	684-3	385	890105M92	712-5	391	89281	72-12	85,88	894835M1	919-5	410
886405M1	684-2	385	89012	131-8	132-139	89283	72-12	85,88	894844M1	171-1	197
886410M1	689-1	385	89018	131-2	131,138	892862M3	231-16	218-231	894900M91	34-2	44,51,58
886428M1	720-1	390	89019	131-2	131,138	892862M3	231-1	218-223,225-231	894902M91	72-20	83
886429M1	720-2	390	890195M1	153-3	155,165	89287	71-34	85	894906M91	621-1	375
886430M92	712-5	391	89020	131-12	132	89293	71-35	85,88	894915M91	72-19	83
886431M92	712-4	391	890222M92	175-3	198	89295	72-12	85,88	894916M91	72-1	83
886432M92	712-5	391	890223M92	176-3	198	89296	71-10	83,84,88,90	894920M91	131-1	132,138
886433M92	712-4	391	890232M91	177-2	201	89297	71-10	83,84,88,90	894923M91	3-19	12
886450M93	712-11	391	89024	131-4	132,138	89298	71-10	83,84,88,90	894924M91	3-19A	12

Les références des pièces sont indicatives.
Nos pièces ne sont pas d'origine

Part numbers are quoted for reference purposes only.
Our parts and accessories are not original.



"THE RELIABLE SERVICE"



**REFERENCES INTERCHANGEABLES
CROSS REFERENCES**

OEM OEM	Réf. Ref.	Page Page	OEM OEM	Réf. Ref.	Page Page	OEM OEM	Réf. Ref.	Page Page	OEM OEM	Réf. Ref.	Page Page
894925M91	3-19B	12	897655M92	759-7	397	898491M92	175-13	199	908430M1	170-3	196
894926M91	3-19C	12	897658M92	760-5	395	898540M91	103-2	122	908463M1	176-35	199
894944M91	2-20B	18	897659M1	762-3	395	898542M92	841-3	424,426	908467M1	176-33	198
894945M91	2-20C	18	897660M1	757-1	396	898580M91	103-3	122	908470M1	176-13	199
894969M92	561-3	379	897677M1			898639M96	432-1	306	908472M1	176-34	198
894974M91	111-1	173,187	+180859M1	730-4	393	898643M1	336-2	282	908487M2	920-80	399
894975M91	96-2	173-175,182	897677M1+			898652M94	432-1	306	908493M3	258-15	246,248
894976M91	96-1	173	897647M1	730-6	393	898654M92	433-2	306	908543M1	1955-380	213-215
894977M91	96-3	173-177,182-187	897677M1	730-6	393	898681M91	450-2	322	908600M1	172-31	194
895322M91	463-2	323,334	897678M93	760-6	395	898713M1	617-1	375-377	908622M1	301-1	275,276
895748M1	6052-1	78-81	897679M94	760-7	395	898745M1	154-8	155,166	908772M1	267-1	254
897001M1	370-4	291,292	897680M2	761-2	395	898748M1	154-9	155-157,164,166	909024M1	907-1	373
897005M1	379-1	299	897681M2	761-3	395	898931M95	432-2	306	909106M1	6492-1	364
897006M1	349-3	285	897683M92	759-4	395	898937M1	336-3	282	909319M3	144-3	141,142,151-153
897050M1	145-5	154	897702M1	461-3	323,334	899130M1	164-3	169	909911M1	485-15	330
897051M1	145-6	154	897711M93	268-2	254	899144M1	153-9	155-157,164,165	909926M91	268-3	254
897065M2	555-1	270,271	897712M2	486-5	331,332,352	899296M91	759-3	395	909971M2	930-11	411-420
897104M92	910-1	399,406,410	897725M1	348-2	285	899304M1	791-3	389	909971M2	930-5	411-420
897105M1	85-12	106	897726M1	350-2	285	899322M92	842-3	424,426	909971M2	930-80	411-417,419,420
897146M94	570-1	367	897751M91	844-12	425	899331M1	245-2	255-260,268	91051	25-2	32,33,39,40
897146M94	570-1E	367	897752M91	844-13	425	899332M92	255-3	249,250	916234M91	181-44	210
897147M95	570-1E	367	897764M1	154-227	155,167	899377M2	292-1	255-259,265,268	916235M91	181-44	210
897147M95	570-1	367	897765M1	153-227	155,165	899385M1	6284-11	268	9211060W1	461-4	323
897153M91	586-1	370	897788M91	847-1	436	899419M92	176-12	198	92421	72-12	85,88
897159M2	570-1B	367	897821M1	843-5	424,426	899421M91	176-12	198	92427	71-10	83,84,88,90
897188M94	150-106	155	897822M1	844-26	424	899423M91	176-9	198	92430	72-10	83,84,89,90
897230M94	471-5	325,326,334	897823M1	844-27	424	899425M92	176-9	198	92432	72-10	83,84,89,90
897231M94	470-5	325,326,334	897913M1	164-6	169	899455M91	174-1	196	92440	72-10	83,84,89,90
897232M1	473-1	322	897914M1	164-5	169	899595M91	690-4	386	92453	72-30	83
897235M1	487-1	331,332,345-348	897923M2	506-1	345,346	899596M91	690-5	386	92463	34-12	45-55,58
897236M94	471-4	325,334	897938M1	167-3	169	899623M1	510-1	349	92463C	34-12C	55
897237M94	470-4	325,334	897949M92	840-3	426	899655M91	176-10	198	92465	34-9	45,49,51,53,58
897242M1	461-2	323,334	897960M92	842-3	424,426	899657M92	176-10	198	92485	1-2	12,18
897268M1	308-4	275,276	898011M1	164-4	169	899663M91	176-13	199	92510	71-10	83,84,88,90
897357M92	150-9	155,164	898016M3	485-4	331	899665M92	176-13	199	930028	96-1	173
897358M4	150-9	155,164	898017M1	489-1	333	899816M1	215-5	238,239	94422	72-5	82,89
897363M1	461-1	323	898018M1	489-2	333	899817M1	219-1	238	94429	71-10	83,84,88,90
897367M1	269-2	254	898019M1	489-3	333	899818M2	202-1	238	94433	1-7	12-14,17,18
897389M91	172-3	194	898020M1	489-3	333	899823M91	212-1	218,219,221,230	94434	1-8	13,17,18
897401M92	6099-6	121	898021M1	438-1	317	899878M1	861-11	427	94435	1-7	12-14,17,18
897403M91	172-1	194	898022M2	436-1	317	899879M1	861-9	427	94436	1-7	12-14,17,18
897414M91	471-1	325	898023M2	505-1	345	899915M92	611-1	376,377	94441	1-34	12,18
897415M91	470-1	325	898050M92	495-8	336,338-340	899971M92	221-93	218	94455	1-34	12,18
897421M91	471-3	325	898053M93	498-4	337-339	90260005	1-2	12,18	94458	1-5	11,18
897422M91	470-3	325	898064M1	153-7	155,164,165	90490014	73-6	83	94464	1-5	11,18
897455M1	153-11	155-157,164,165	898065M1	154-7	155,164,166	90563	79-1	93	94475	72-10	83,84,88,90
897456M96	471-6	325	898076M1	106-2	121	906055M3	920-80	399	94485	72-9	83,90
897457M96	470-6	325	898085M91	450-1	322	906055M3	920-17	399,400,401,403	94490	72-12	85,88
897471M91	468-2	324	898090M1	930-10	411-414,416,420	906055M3	920-1	399,400,403,410	94493	72-12	85,88
897475M96	471-10	326,327	898090M1	930-4	411-414,416,420	906070M1	182-2	211	94494	72-12	85,88
897476M96	470-10	326,327	898090M1	930-87	411-414,416,420	906071M1	182-1	211	950196	96-1	173
897491M1	605-2	376	898090M1	930-90	411-414,416,420	906106M93	490-3	337,338,340	952400M1	372-35	290
897491MIASSY	605-2A	376	898104M1	163-3	190	906186M95	470-43	328	9583	150-76	155
897492M1	601-2	376-378	898122M91	696-1	386	906254M2	761-9	397	958826M1	908-1	373
897493M1	602-2	376-378	898124M1	697-1	386	906263M2	710-4	389	95963J	930-10	411-414,416,420
897504M1	614-1A	376-378	898127M2	699-1	386	906309M94	760-7	395	95963J	930-4	411-414,416,420
897507M94	615-2	376	898129M92	695-1	386	906352M1	176-34	198	95963J	930-87	411-414,416,420
897541M92	498-3	336,338	898136M1	676-2	384	906424M2	144-265	145	95963J	930-90	411-414,416,420
897560M3	693-3	386	898202M1	614-2	376-378	906468M1	294-2	255,256	960017M95	844-10	425
897561M91	690-4	386	898221M96	471-9	326,327,334	906469M1	294-1	255,256,257	960017M95	844-11	425
897564M1	692-2	386	898222M96	470-9	326,327,334	906472M2	278-2	261	960022M1	910-1	399,406,410
897567M3	685-2	385	898228M94	165-2	170	906501M2	163-46	190	960023M1	910-1	399,406,410
897568M1	684-2	385	898228M94	165-2S	170	906502M1	153-111	155-157,165	960256M1	176-35	199
897569M91	471-2	325	898229M1	661-1	383	906503M1	154-114	155,156,157,166	960265M1	173-3	197
897570M91	470-2	325	898326M92	673-1	384	906509M92	163-12	190	960347M1	168-23	193
897571M91	471-3	325	898346M93	450-4	322	906743M92	278-2	261	960493M1	176-13	199
897572M91	470-3	325	898347M92	450-4	322	906755M1	258-1	245,246,247,248	960549M1	492-12	336,338
897575M1	682-1	385	898349M2	451-1	322	906863M1	446-2	319	960690M91	111-2	173
897578M1	682-4	385	898350M1	473-5	322	906919M91	255-1	245	960840M1	510-2	349
897579M1	682-4	385	898354M1	501-1	345	907090M93	221-62	219-228,231	960852M91	1920-7	215
897594M6	693-4	386	898355M91	501-2	346-348	907462M94	168-4	193	960941M1	177-6	201
897595M91	690-5	386	898358M1	500-2	346	907485M1	477-50	327,328	960972M1	144-266	143
897597M1	692-3	386	898359M2	505-2	346,348	907536M1	491-29	336,338	961041M91	842-2	426
897599M1	614-1B	376-378	898363M1	577-1	370	907555M91	740-37	394	961158M1	761-36	397
897625M94	482-2	324	898366M2	576-1	370	907559M92	740-37	394	961334M92	841-3	424,426
897647M1+			898390M91	158-6	191	907560M92	740-37	394	961395M3	844-27	424
897677M1	730-6	393	898418M1	171-1	197	907564M1	740-37	394	961424M1	176-35	199
897650M1	761-7	397	898465M91	175-9	198	907980M1	761-3	395	9617	150-1	155
897649M95	760-12	397	898467M92	175-9	198	907981M91	759-4	395	961866M1	1955-410	210,211
897651M1	761-8	397	898485M91	175-12	198	908371M91	497-29	337,339	962049M1	172-1	194
897652M1	766-2	396	898487M92	175-12	198	908427M1	171-3	197	962071M93	150-4	155,164
897653M2	757-2	396	898489M91	175-13	199	908428M1	173-3	197	962139M91	847-3	436

Les références des pièces sont indicatives.
Nos pièces ne sont pas d'origine

Part numbers are quoted for reference purposes only.
Our parts and accessories are not original.



REFERENCES INTERCHANGEABLES
CROSS REFERENCES

OEM OEM	Réf. Ref.	Page Page	OEM OEM	Réf. Ref.	Page Page	OEM OEM	Réf. Ref.	Page Page	OEM OEM	Réf. Ref.	Page Page
962148M91	847-1	436	968721M1	144-3	141,142,151-153	A5BD1969	40-3	61,68	B1223	32-23	47,50
962184M2	144-3	141,142,151-153	968772M1	73-2	83,90	A5BD2383	40-6	62,66,67,69	B1226	32-57	46,49,52
962384M3	172-9	194	968816M2	151-15	157,158	A5BD2631	40-6	62,66,67,69	B1227	32-59	46
962386M3	172-32	194	968856M1	930-10	411-414,416,420	A5BD2722	40-3	61,68	B1228	35-1	44,57
962464M91	712-2	391	968856M1	930-4	411-414,416,420	A5BD2923	40-6	62,66,67,69	B1229	35-3	43,44,57
962702M91	497-30	337,338	968856M1	930-87	411-414,416,420	A5FH0197	79-1	93	B1243	92-3	112,113
962840M1	208-1	238,239	968856M1	930-90	411-414,416,420	A5FH0245	79-1	93	B1244	92-4	112,113
962842M2	183-3	211	968903M1	173-1	197	AAK3350	920-108	401-405,407,408	B1250	475-1	325,334
963023M2	105-1	122	968976M1	151-2	155,164	AAK3350	920-74	403-405	B12501	125-1	129
963023M2	105-2	122	968976M2	151-2	155,164	AAK3350	920-155	404	B12502	125-2	129
963115M2	168-24	193	969269M91	96-2	173-175,182	AAK3350	920-132	404,405	B1251	475-2	325
963213M1	109-3	130	969287M1	375-1	290	AAK3350	920-156	404,405	B1252	475-3	325,326,327,334
963416M1	950-1	203	969345M91	601-1	375	AAK3354	920-108	401-405,407,408	B1253	475-3	325,326,327,334
963417M2	187-1	207	969352M91	492-1	336,338,340	AAK3354	920-74	403-405	B1254	475-3	325,326,327,334
963418M1	180-4	208	969353M1	165-157	170	AAK3354	920-155	404	B1272	475-23	334
963434M91	181-3	210	969433M2	212-1	218,219,221,230	AAK3354	920-132	404,405	B16100	161-104	178,180,184,185
963435M91	181-4	210	969567M91	471-45	325	AAK3354	920-156	404,405	B161105	161-105	185
963436M1	181-67	210	969568M91	470-45	325	AAK3355	920-108	401-405,407,408	B161153	161-153	184
963437M1	181-66	210	969606M2	180-4	208	AAK3355	920-74	403-405	B16160	161-60	177,185,177
963519M1	450-11	322	969771M1	762-40	397	AAK3355	920-156	404,405	B16163	161-63	174
963533M1	477-19	325	969945M91	169-15	191	AAK5189	920-108	401-405,407,408	B16177	161-77	179,180,187
963534M1	452-16	322	973085M93	173-4	197	AAK5189	920-74	403-405	B16178	161-78	176,177,188
963604M2	449-16	321	973231M1	304-18	279	AAK5189	920-155	404	B16198	161-98	175,177
963717M1	181-66	210	973284M1	305-21	279,298	AAK5189	920-132	404,405	B16264	162-64	185
963718M1	181-67	210	973302M1	354-19	361	AAK5189	920-156	404,405	B16277	162-77	179,180,187
963757M2	953-1	203	973313M1	353-11	289,296,298,361	AAK5195	920-132	404,405	B16278	162-78	176,177,188
963781M1	552-1	272	973875M1	353-13	361	AAK5195	920-156	404,405	B16816	168-16	193
963824M91	842-1	424,426	974436M1	6683-16	279	AAK-IV	920-132	404,405	B16817	168-17	193
963825M91	842-1	424,426	974535M2	240-27	185	AER1503	919-19	409	B16911	169-11	193
963829M91	842-3	424,426	974717M1	233-9	307	AER1528	919-21	409	B2000	900-1	373
963839M1	221-94	218	975008M1	9604-130	92	AER1535	919-17	409	B2001	900-2	373
963840M1	221-1	218,219,221,230	975086M1	556-11	274	AER1560	919-3	409	B220D	2-20D	18
963840M1	221-1L	218,219,221,230	975124M1	440-35	314	AZF4520	930-11	411-420	B220E	2-20E	18
963868M92	485-1	330	975125M1	372-25	295,298	AZF4520	930-5	411-420	B220F	2-20F	18
963916M1	495-8	336,338-340	975127M1	371-29	295,298	AZF4520	930-80	411-417,419,420	B30101S	30-101S	41
963920M1	498-5	336,338-340	975208M1	477-39	329	AZF4520	930-180	414,417	B30107S	30-107S	41
963922M1	497-5	337-340	976642M1	556-11	274	AZF4542	930-38	416-418	B30108S	30-108S	41
963929M1	145-5	154	976731M1	141-3	131,138,140	AZF4542	930-181	417,418	B30112S	30-112S	41
963930M1	145-6	154	976913M1	6407-18	297,357	B1001	606-1	375,376	B30116S	30-116S	42
964098M1	150-10	155,164	979844M1	440-35	314	B1002	606-2	377	B30117S	30-117S	42
964142M1	477-20	325	981843M3	233-10	240,308	B1003	72-1	83	B30186S	30-186S	42
964217M1	158-6	191	982041M2	9604-130	92	B1005	606-3	378	B3109S	31-9S	53
964248M1	953-1	203	982211M1	9604-130	92	B1020	460-4	323	B31108	31-108	46,48,50,52,54
964310M4	485-28	330	982580M2	9604-130	92	B1060	425-1	307	B31108S	31-108S	54
964321M91	471-44	325	9AR2566K	920-17	399,400,401,403	B1061	425-2	307	B3111	31-11	43,51
964322M91	470-44	325	9AR2566K	920-1	399,400,403,410	B1100	31-8	43,44,51,53	B31140	31-140	43,50
964341M91	492-27	337,338	9AR2566K	920-82	400,401	B1101	31-9	45,51,53	B31173	31-173	46,48,50,52,54
964382M1	930-10	411-414,416,420	9AR2566K	920-50	400,401,403,404	B1102	31-10	45,51	B31173S	31-173S	54
964382M1	930-4	411-414,416,420	9AR2566K	920-92	400,401,403,404	B1103	31-12	45	B31174	31-174	48
964382M1	930-87	411-414,416,420	9AR2567F	920-17	399,400,401,403	B1105	31-14	45,52,53	B31176	31-176	47,52,54
964382M1	930-90	411-414,416,420	9AR2567F	920-1	399,400,403,410	B1106	31-15	46,53	B31176S	31-176S	54
964416M91	403-1	300	9AR2567F	920-81	400	B1107	31-16	44	B31177S	31-177S	43
964434M1	757-1	396	9AR2567F	920-50	400,401,403,404	B1110	31-20	49	B31178S	31-178S	43
964516M1	486-3	330,331,332	9AR2567F	920-92	400,401,403,404	B1111	31-21	46,52	B31179	31-179	46
964669M1	768-1	396	9AR2725F	920-80	399	B1112	31-70	47,50,54	B31183	31-183	46,53
964672M91	761-50	397	9AR2725F	920-17	399,400,401,403	B1114	31-18	47	B31183S	31-183S	53
964894M1	551-16	274	9AR2725F	920-1	399,400,403,410	B1123	31-23	47,50	B3114S	31-14S	53
964908M91	255-1	245	9AR2851K	920-17	399,400,401,403	B1124	31-24	47	B31200S	31-200S	49
964916M1	276-1	261	9AR2851K	920-1	399,400,403,410	B1125	31-41	44	B31203S	31-203S	49
964917M2	259-1	252,253	9AR2851K	920-82	400,401	B1126	31-57	46,49,52,53	B3157S	31-57S	53
964918M91	265-4	252	9AR2851K	920-50	400,401,403,404	B1129	31-3	43,44,53	B3158	31-58	46,49,52,53
964925M3	258-1	245,246,247,248	9AR2851K	920-92	400,401,403,404	B1198	32-1	44	B3158S	31-58S	53
964926M3	258-2	245,247,248	9AR2887F	920-17	399,400,401,403	B1199	32-2	44,51	B3160	31-60	45,49
964961M1	258-1	245,246,247,248	9AR2887F	920-1	399,400,403,410	B1200	32-8	43,44,51	B3169	31-69	45,50,52,53
965447M91	831-1	429	9AR2887F	920-81	400	B1201	32-9	45,49,51	B3169S	31-69S	53
965591M91	96-1	173	9AR2887F	920-50	400,401,403,404	B1202	32-10	45,51	B3172S	31-72S	43
965593M91	111-1	173,187	9AR2887F	920-92	400,401,403,404	B1203	32-12	45,49,55	B3173	31-73	45,49
966170M91	212-56	218	9AR2944K	920-17	399,400,401,403	B1203C	32-12C	55	B3174	31-74	45,49,50,52,53
966172M91	221-94	218	9AR2944K	920-1	399,400,403,410	B1204	32-13	46,49	B3177	31-77	47,50,54
966238M1	371-2	291	9AR2944K	920-50	400,401,403,404	B1206	33-40	44,56	B3181S	31-81S	43
966427M1	144-267	142,144,147,148	9AR2944K	920-92	400,401,403,404	B1207	32-16	44	B319D	3-19D	12
966558M1	163-47	190	9AR5092	920-10	401,402,406-408	B1208	33-1	44,56	B319E	3-19E	12
967570M4	950-1	203	9AR5092	920-4	401-410	B1209	33-41	44,56	B319F	3-19F	12
967572M1	177-3	201	9AR5092	920-11	401,402,410	B1210	32-20	49	B320F	3-20F	12,18
967725M1	212-56	218	A1271R	920-50	400,401,403,404	B1211	32-21	46,52	B32108	32-108	46,48,50,52
967906M1	832-1	429	A1271R	920-132	404,405	B1212	32-22	47,50,55	B32109	32-109	47,50
968296M1	930-10	411-414,416,420	A1271R	920-156	404,405	B1212C	32-22C	55	B3211	32-11	43,51
968296M1	930-4	411-414,416,420	A5BD1134	40-6	62,66,67,69	B1214	32-18	47,55	B32173	32-173	46,48,50,52
968296M1	930-87	411-414,416,420	A5BD1135	40-6	62,66,67,69	B1214C	32-18C	55	B32174	32-174	48
968296M1	930-90	411-414,416,420	A5BD1136	40-6	62,66,67,69	B1216	34-40	44,58	B32176	32-176	47,52
968479M1	96-2	173-175,182	A5BD1137	40-6	62,66,67,69	B1218	34-1	44,58	B32177	32-177	43
968614M91	96-2	173-175,182	A5BD1138	40-6	62,66,67,69	B1219	34-41	44,58	B32178	32-178	43

Les références des pièces sont indicatives.
Nos pièces ne sont pas d'origine

Part numbers are quoted for reference purposes only.
Our parts and accessories are not original.



REFERENCES INTERCHANGEABLES
CROSS REFERENCES

OEM OEM	Réf. Ref.	Page Page	OEM OEM	Réf. Ref.	Page Page	OEM OEM	Réf. Ref.	Page Page	OEM OEM	Réf. Ref.	Page Page
B32179	32-179	46	D41613500	6412-4	357	PF53918	168-6	193	U5BG0026	1-8	13,17,18
B32182	32-182	46,50,52	D41999100	144-268	150	PF60037	169-11	193	U5BG0027	1-5	11,18
B32183	32-183	46	D45465400	687-1	385	PF60074	169-11	193	U5BG0028	1-2	12,18
B3269	32-69	45,49,50,52	DCB121	982-1	93	PMC138	410-1	311	U5BG0031	1-1	11,18
B3272	32-72	43,51	DDB163	983-1	93	SRB310	940-1	421	U5BG0034	1-32	15,17
B3273	32-73	45,49	DRB126	980-1	93	SRB325	940-4	421	U5BG0035	1-32	15,17
B3274	32-74	45,49,50,52	DSB122	981-1	93	TAB118	933-3	423	U5BG0036	1-29	15,17
B3277	32-77	47,50	LRA220	920-92	400,401,403,404	TAB125	933-2	423	U5BG0037	1-29	15,17
B3413	341-3	283	LRA361	920-1	399,400,403,410	TCB118	934-1	423	U5BG0038	1-32	15,17
B3414	341-4	283	LRA380	920-50	400,401,403,404	TEB103	932-4	423	U5BG0042	1-72	15
B3902	39-2	60	LRA460	920-11	401,402,410	TEB104	932-3	423	U5BG0052	1-7	12-14,17,18
B3903	39-3	60	LRA582	920-10	401,402,406-408	TEB110	932-3	423	U5BG0053	1-4	12,17
B3904	39-4	60	LRA583	920-4	401-410	TEB129	932-4	423	U5BG0054	1-4	12,17
B3905	39-5	60	LRC102	919-4	410	TEB132	932-3	423	U5LB0002	72-12	85,88
B3908	39-8	60	LRC107	919-2	410	TEB144	932-7	423	U5LB0003	72-10	83,84,89,90
B3909	39-9	60	LRC108	919-5	410	TIB108	931-5	423	U5LB0004	72-10	83,84,89,90
B3912	39-12	60	LRC193	919-1	410	TIB113	931-3	423	U5LB0005	72-10	83,84,89,90
B3913	39-13	60	LRD101	910-1	399,406,410	TIB114	931-4	423	U5LB0010	72-5	82,89
B3915	39-15	60	LRS101	930-1	411	TJB103	931-7	423	U5LB0011	72-5	82,89
B3916	39-16	60	LRS137	930-11	411-420	TJB104	931-8	423	U5LB0012	72-5	82,89
B3918	39-18	60	LRS137	930-5	411-420	TJB107	931-6	423	U5LB0016	72-10	83,84,89,90
B41402	414-2	311	LRS137	930-80	411-417,419,420	TJB111	931-9	423	U5LB0020	72-12	85,88
B41626	416-26	303,304	LRS157	930-3	411	TJB112	931-10	423	U5LB0021	72-57	85,88
B46037	460-37	323	LRS161	930-38	416-418	TJB114	931-9	423	U5LB0022	72-57	85,88
B46038	460-38	323	LRS162	930-11	411-420	TLB117	939-3	422	U5LB0023	72-57	85,88
B46039	460-39	323	LRS162	930-5	411-420	TLB118	939-5	422	U5LB0024	72-12	85,88
B46040	460-40	323	LRS162	930-80	411-417,419,420	TMB100	939-12	422	U5LB0034	72-90	89
B47526	475-26	325	LRS190	930-10	411-414,416,420	TMB102	939-13	422	U5LB0035	72-10	83,84,89,90
B47527	475-27	326,327,328	LRS190	930-4	411-414,416,420	TMB105	939-7	422	U5LB0036	72-91	86
B47528	475-28	327,328	LRS190	930-87	411-414,416,420	TMB120	939-8	422	U5LB0037	72-10	83,84,89,90
B47529	475-29	327,328	LRS190	930-90	411-414,416,420	TNB165	939-15	422	U5LB0043	72-12	85,88
B47530	475-30	327	LRS215	930-5	411-420	TNB169	939-16	422	U5LB0045	72-10	83,84,89,90
B47531	475-31	328	LRS232	930-11	411-420	TOB100	940-5	421	U5LB0049	72-57	85,88
B47532	475-32	326,328	LRS232	930-5	411-420	TOB108	940-9	421	U5LB0050	72-12	85,88
B47533	475-33	328	LRS232	930-80	411-417,419,420	TOB109	940-6	421	U5LB0051	72-90	89
B47534	475-34	328	LRS301	930-10	411-414,416,420	TOB110	940-9	421	U5LB0053	72-91	86
B47535	475-35	325	LRS302	930-38	416-418	TOB111	940-9	421	U5LB0055	72-57	85,88
B57414	574-14	177,186,187	LRS306	930-11	411-420	TOB113	940-6	421	U5LB0056	72-12	85,88
B57901	579-1	370	LRS306	930-5	411-420	TOB121	940-6	421	U5LB0110	72-5	82,89
B601	6-1	11,12,18,19	LRS306	930-80	411-417,419,420	TOB133	940-9	421	U5LB0111	72-5	82,89
B602	6-2	11,12,18,19	LRS519	930-11	411-420	TOB134	940-6	421	U5LB0112	72-5	82,89
B603	6-3	12-15,17-19	LRS553	930-16	415	TOB151	940-5	421	U5LB0116	72-30	83
B604	6-4	12-15,17-19	M35G/1	930-1	411	TOB153	940-5	421	U5LB0117	72-9	83,90
B6081	608-1	375	M512136	4001-9	441	TOB162	940-6	421	U5LB0136	72-91	86
B6082	608-2	376	M524043	4022-39	441	TOB179	940-9	421	U5LB0141	72-90	89
B6083	608-3	378	M534199	4021-39	441	TOB184	940-9	421	U5LB0145	72-10	83,84,89,90
B613	6-13	12	M544162	4012-52	441	TPB104	940-12	421	U5LB0146	72-113	84,85,88,90
B61401	614-1	376-378	M544516	4047-57	441	TPB107	940-6	421	U5LB0151	72-90	89
B631001	6310-1	264	M555041	4071-29	441	TPB109	940-6	421	U5LB0153	72-91	86
B64182	6418-2	364	M7BJ0014	25-2	32,33,39,40	TPB111	940-12	421	U5LB0155	72-57	85,88
B6914	691-4	386	M7BJ0015	25-3	33-36,38-40	TPB112	940-14	421	U5LB0156	72-12	85,88
B6915	691-5	386	M7BJ0052	25-1	32,33,39,40	TPB113	940-14	421	U5LB0218	72-107	82
B7654	765-4	396	MIN56	411-5	311	TPB116	940-12	421	U5LB0221	72-31	84,90
B8601	860-1	427	NAB301	920-5	406,407	TPB118	940-12	421	U5LB0304	72-105	82
B8602	860-2	427	NCB112	919-4	410	TPB119	940-12	421	U5LB0308	72-106	86
B8603	860-3	427	NCB113	919-1	410	TPB122	940-14	421	U5LB0317	72-113	84,85,88,90
B8604	860-4	427	NCB118	919-2	410	U3174P412	45-64	72,75,76	U5LB0319	72-114	84,85
B8605	860-5	427	NCB119	919-5	410	U3316A013	41-60	61	U5LB0334	72-106	86
B8606	860-6	428	NCB120	919-2	410	U3316A032	41-20	61,62,68	U5LB0338	72-91	86
B8607	860-7	428	NSB505	930-5	411-420	U3482M016	141-132	133,135,137,140	U5LB0358	72-107	82
B8608	860-8	428	NSB509	930-4	411-414,416,420	U4131A044	130-194	133,135,137	U5LB0359	72-107	82
B8609	860-9	428	NSB513	930-3	411	U4131A046	130-198	133,135	U5LB0501	75-4	82,89
B8610	860-10	428	NSB528	930-16	415	U5BD0001	40-6	62,66,67,69	U5LB0502	72-6	83,90
B8612	860-12	428	NSB529	930-11	411-420	U5BD0004	40-6	62,66,67,69	U5LB1110	72-107	82
B8618	860-18	428	NSB530	930-10	411-414,416,420	U5BD0005	40-6	62,66,67,69	U5LB1111	72-5	82,89
B8619	860-19	428	OSPB1000N	560-16	379	U5BD0007	40-6	62,66,67,69	U5LB1112	72-5	82,89
B8620	860-20	428	OSPB1250N	560-29	379	U5BD0024	40-1	61,68	U5LB1116	72-30	83
B8621	860-21	428	OSPB1250N	560-31	379	U5BD0028	40-4	62,69	U5LB1117	72-9	83,90
B8622	860-22	428	OSPC1000N	560-2D	379	U5BD0136	40-6	62,66,67,69	U5LB1157	72-5	82,89
B8624	860-24	428	OSPC1000N	560-30	379	U5BG0005	1-8	13,17,18	U5LB1158	72-51	83,84
B8632	863-2	427	OSPC1000N	560-32	379	U5BG0007	1-26	11,18	U5LB1160	72-113	84,85,88,90
B8761	225-1	238	OSPC200LS	560-33	379	U5BG0008	1-8	13,17,18	U5LB1164	72-90	89
B8762	225-2	239	PF125922	1-2	12,18	U5BG0009	1-8	13,17,18	U5LB1167	72-91	86
B8765	224-1	238	PF125982	73-4	82,89	U5BG0012	1-1	11,18	U5LB1168	72-91	86
B8766	224-2	239	PF225507	73-11	83,84,88,90	U5BG0016	1-2	12,18	U5LB1224	72-12	85,88
B91917	919-17	409	PF225536	73-11	83,84,88,90	U5BG0017	1-2	12,18	U5LB1225	72-57	85,88
B923	92-3	112,113	PF225656	73-11	83,84,88,90	U5BG0019	1-7	12-14,17,18	U5LB1319	72-114	84,85
B9734	97-34	179,187	PF52842	143-3	141-147,150-153	U5BG0021	1-26	11,18	U5LB1331	72-106	86
D11E84	930-10	411-414,416,420	PF53270	55-2	155-157,160-164	U5BG0022	1-8	13,17,18	U5LH0003	33-173	46,48,50,52,54,56
D11E84	930-4	411-414,416,420	PF53636	11-1	20,21,28,29	U5BG0023	1-8	13,17,18	U5LH0006	33-177	43,56
D11E84	930-87	411-414,416,420	PF53636	11-10	20,21,28,29	U5BG0024	1-7	12-14,17,18	U5LH0007	33-178	43,56
D11E84	930-90	411-414,416,420	PF53799	168-6	193	U5BG0025	1-8	13,17,18	U5LL0001	33-108	46,48,50,52,54,56

Les références des pièces sont indicatives.
Nos pièces ne sont pas d'origine

Part numbers are quoted for reference purposes only.
Our parts and accessories are not original.



"THE RELIABLE SERVICE"



**REFERENCES INTERCHANGEABLES
CROSS REFERENCES**

OEM OEM	Réf. Ref.	Page Page	OEM OEM	Réf. Ref.	Page Page	OEM OEM	Réf. Ref.	Page Page	OEM OEM	Réf. Ref.	Page Page
USLL0002	33-108	46,48,50,52,54,56	USLT0181	71-12	85,88	USME0006	3-28	14,17,18	USMK0278	30-111	41
USLL0004	33-109	47,50,56	USLT0186	71-35	85,88	USME0006A	3-28A	14,17,18	USMK0279	30-116	42
USLL0005	33-108	46,48,50,52,54,56	USLT0191	71-59	85,88	USME0006B	3-28B	14,17,18	USMK0280	30-112	41
USLL0006	33-109	47,50,56	USLT0196	71-90	84,89,90	USME0006C	3-28C	14,17,18	USMK0281	30-110	41
USLL0008	33-109	47,50,56	USLT0202	71-82	84,85,89,90	USMH0001	142-1	131,138,140	USMK0282	30-113	41
USLL0009	33-108	46,48,50,52,54,56	USLT0215	71-90	84,89,90	USMH0006	141-3	131,138,140	USMK0283	30-118	42
USLL0011	33-108	46,48,50,52,54,56	USLT0216	71-81	82	USMH0011	141-4	132,138,140	USMK0284	30-119	42
USLL0012	33-108	46,48,50,52,54,56	USLT0217	71-81	82	USMH0017	142-8	131,138,140	USMK0285	30-108	41
USLL0013	33-108	46,48,50,52,54,56	USLT0218	71-5	82,89	USMH0018	142-2	132,138,140	USMK0286	31-69	45,50,52,53
USLL0014	33-108	46,48,50,52,54,56	USLT0300	71-115	86	USMH0021	141-64	132,138,140	USMK0287	30-114S	42
USLL0015	33-109	47,50,56	USLT0301	71-115	86	USMH0023	141-65	133,136,140	USMK0288	30-103	41
USLL0021	33-176	47,52,54,56	USLT0307	71-90	84,89,90	USMH0024	141-11	133,137,139,140	USMK0289	30-106	41
USLL0024	33-173	46,48,50,52,54,56	USLT0309	71-109	86	USMH0025	142-17	133,139,140	USMK0290	30-100	41
USLL0029	33-178	43,56	USLT0310	71-115	86	USMH0026	142-3	133,140	USMK0291	30-101	41
USLL0030	33-177	43,56	USLT0314	71-90	84,89,90	USMH0027	142-31	134,140	USMK0292	30-102	41
USLL0031	33-183	46,53,56	USLT0317	71-83	85,89	USMH0028	141-12	134,140	USMK0293	30-107	41
USLL0039	33-179	46,56	USLT0327	71-82	84,85,89,90	USMH0029	142-30	134,140	USMK0294	30-108	41
USLL0044	33-72	43,51,56	USLT0329	71-115	86	USMH0031	141-61	137,140	USMK0295	30-117	42
USLP0006	33-73	45,49,56	USLT0383	71-108	83	USMH0032	141-60	134,137,140	USMK0319	30-184	42
USLP0009	33-57	46,49,50,52,53,56	USLT0509	71-7	83,90	USMH0033	141-62	137,140	USMK0320	30-185	42
USLP0013	33-73	45,49,56	USLT0511	71-107	82	USMH0047	142-9	133,140	USMK0321	30-181S	41
USLP0014	33-77	47,50,54,56	USLT0512	71-3	82,89	USMH0050	141-133	134,137,140	USMK0398	75-110	85,88
USLP0017	33-72	43,51,56	USLT0515	71-10	83,84,88,90	USMH0052	141-10	133,140	USMK0401	14-1	20,21,28,29
USLP0019	33-77	47,50,54,56	USLT0518	71-59	85,88	USMH0053	141-131	133,139,140	USMK0404	14-3	22,24,26,27,29
USLP0021	33-77	47,50,54,56	USLT0520	71-31	84,90	USMH0056	141-132	133,135,137,140	USMK0700	30-103	41
USLP0022	33-74	45,49,50,52,53,56	USLT0521	71-12	85,88	USMH0063	141-63	135,140	USMK0700K	30-103S	41
USLP0029	33-72	43,51,56	USLT0523	71-30	83	USMH0065	141-4	132,138,140	USMK0701	30-102	41
USLP0035	33-69	45,49,50,52,53,56	USLT0525	71-34	85	USMK0029	31-59	46	USMK0701K	30-102S	41
USLP0046	33-74	45,49,50,52,53,56	USLT0537	71-9	82,89	USMK0033	31-5	43,44,51,53	USMK0704	30-110	41
USLP0057	33-173	46,48,50,52,54,56	USLT0538	71-5	82,89	USMK0034	31-7	43,44,51,53	USMK0704K	30-110S	41
USLP0058	33-182	46,50,52,56	USLT0546	71-53	83,88-90	USMK0035	31-7S	53	USMK0705	30-113	41
USLT0002	71-59	85,88	USLT0565	71-52	83,84,88-90	USMK0036	31-16	44	USMK0705K	30-113S	41
USLT0004	71-59	85,88	USLT1002	71-52	83,84,88-90	USMK0037	31-201S	49	USMK0706	30-115	42
USLT0007	71-10	83,84,88,90	USLT1004	71-52	83,84,88-90	USMK0038	31-12	45	USMK0706K	30-115S	42
USLT0008	71-10	83,84,88,90	USLT1006	71-53	83,88-90	USMK0039	31-13S	46,49	USMK0708	30-182	42
USLT0012	71-3	82,89	USLT1007	71-53	83,88-90	USMK0040	31-39S	50	USMK0708K	30-182S	42
USLT0013	71-5	82,89	USLT1014	71-10	83,84,88,90	USMK0041	31-70	47,50,54	USMK0709	30-183	42
USLT0014	71-9	82,89	USLT1138	71-5	82,89	USMK0056	31-3S	53	USMK0709K	30-183S	42
USLT0015	71-10	83,84,88,90	USLT1139	71-5	82,89	USMK0058	31-5S	53	USMK0710	30-118	42
USLT0016	71-10	83,84,88,90	USLT1178	71-90	84,89,90	USMK0059	31-8S	53	USMK0710K	30-118S	42
USLT0017	71-59	85,88	USLT1181	71-12	85,88	USMK0064	31-4	43,44,51	USMK0711	30-119	42
USLT0018	71-59	85,88	USLT1186	71-35	85,88	USMK0065	31-202S	49	USMK0711K	30-119S	42
USLT0021	71-12	85,88	USLT1190	71-59	85,88	USMK0066	31-9	45,51,53	USMK0712	30-185	42
USLT0025	71-34	85	USLT1192	71-59	85,88	USMK0067	31-15	46,53	USMK0712K	30-185S	42
USLT0026	71-35	85,88	USLT1196	71-90	84,89,90	USMK0068	31-79S	54	USMK0713	30-111	41
USLT0033	71-59	85,88	USLT1202	71-82	84,85,89,90	USMK0071	31-78	47,50,54	USMK0713K	30-111S	41
USLT0034	71-59	85,88	USLT1300	71-115	86	USMK0075	30-103	41	USMK0714	30-184	42
USLT0036	71-10	83,84,88,90	USLT1309	71-115	86	USMK0076	30-106	41	USMK0714K	30-184S	42
USLT0037	71-9	82,89	USLT5138	71-5	82,89	USMK0083	30-100	41	USMW0009	130-14	133,139
USLT0038	71-5	82,89	USMB0007	2-52	15	USMK0084	30-101	41	USMW0010	130-4	132,138
USLT0042	71-10	83,84,88,90	USMB0007A	2-52A	15	USMK0085	30-102	41	USMW0014	130-13	133
USLT0043	71-10	83,84,88,90	USMB0007B	2-52B	15	USMK0086	30-110	41	USMW0016	130-48	134
USLT0046	71-53	83,88-90	USMB0007C	2-52C	15	USMK0088	30-102	41	USMW0023	130-6	131,138
USLT0051	71-91	86	USMB0008	2-76	11,18	USMK0089	30-107	41	USMW0040	130-12	132
USLT0052	71-52	83,84,88-90	USMB0008A	2-76A	11,18	USMK0090	30-108	41	USMW0041	130-12	132
USLT0053	71-10	83,84,88,90	USMB0008B	2-76B	11,18	USMK0091	30-110	41	USMW0054	130-12	132
USLT0057	71-52	83,84,88-90	USMB0008C	2-76C	11,18	USMK0092	30-115	42	USMW0055	130-4	132,138
USLT0059	71-52	83,84,88-90	USMB0009	2-45	15	USMK0093	30-117	42	USMW0061	130-4	132,138
USLT0062	71-10	83,84,88,90	USMB0009A	2-45A	15	USMK0117	31-8	43,44,51,53	USMW0064	130-8	132,136,137,139
USLT0063	71-52	83,84,88-90	USMB0009B	2-45B	15	USMK0124	31-15S	53	USMW0089	130-4	132,138
USLT0064	71-52	83,84,88-90	USMB0009C	2-45C	15	USMK0125	31-24	47	USMW0092	130-91	134
USLT0065	71-52	83,84,88-90	USMB0010	2-45	15	USMK0127	31-70	47,50,54	USMW0095	130-31	133,137,139
USLT0066	71-52	83,84,88-90	USMB0010A	2-45A	15	USMK0128	31-70S	54	USMW0097	130-6	131,138
USLT0067	71-52	83,84,88-90	USMB0010B	2-45B	15	USMK0130	31-77S	54	USMW0104	130-8	132,136,137,139
USLT0069	71-8	83,90	USMB0010C	2-45C	15	USMK0131	31-78S	54	USMW0106	130-71	133,136
USLT0073	71-5	82,89	USMB0011	2-4	15,17	USMK0136	30-103	41	USMW0108	130-31	133,137,139
USLT0074	71-10	83,84,88,90	USMB0014	2-77	11	USMK0142	31-109	47,50	USMW0111	130-10	136
USLT0076	71-52	83,84,88-90	USMB0014A	2-77A	11	USMK0147	30-106	41	USMW0118	130-48	134
USLT0078	71-90	84,89,90	USMB0014B	2-77B	11	USMK0149	30-100	41	USMW0128	130-88	134
USLT0079	71-91	86	USMB0014C	2-77C	11	USMK0150	30-101	41	USMW0129	130-49	134,137
USLT0080	71-5	82,89	USME0002	3-28	14,17,18	USMK0151	30-110	41	USMW0132	130-196	137
USLT0081	71-8	83,90	USME0002A	3-28A	14,17,18	USMK0152	30-102	41	USMW0133	130-32	134
USLT0100	71-8	83,90	USME0002B	3-28B	14,17,18	USMK0153	30-107	41	USMW0140	130-91	134
USLT0102	71-108	83	USME0002C	3-28C	14,17,18	USMK0154	30-108	41	USMW0144	130-90	137
USLT0144	71-5	82,89	USME0003	3-29	15,17	USMK0155	30-115	42	USMW0147	130-13	133
USLT0149	71-90	84,89,90	USME0003A	3-29A	15,17	USMK0156	30-117	42	USMW0154	130-194	133,135,137
USLT0151	71-91	86	USME0003B	3-29B	15,17	USMK0169	31-74	45,49,50,52,53	USMW0155	130-198	133,135
USLT0156	71-90	84,89,90	USME0003C	3-29C	15,17	USMK0170	31-74S	53	USMW0156	130-197	134
USLT0174	71-10	83,84,88,90	USME0005	3-76	11,18	USMK0171	31-14	45,52,53	USMW0157	130-90	137
USLT0175	71-53	83,88-90	USME0005A	3-76A	11,18	USMK0275	31-108	46,48,50,52,54	USMW0159	130-193	134
USLT0178	71-90	84,89,90	USME0005B	3-76B	11,18	USMK0276	30-105S	41	USMW0160	130-199	134
USLT0179	71-91	86	USME0005C	3-76C	11,18	USMK0277	30-105S	41	USMW0164	130-194	133,135,137

Les références des pièces sont indicatives.
Nos pièces ne sont pas d'origine

Part numbers are quoted for reference purposes only.
Our parts and accessories are not original.



"THE RELIABLE SERVICE"



**REFERENCES INTERCHANGEABLES
CROSS REFERENCES**

OEM OEM	Réf. Ref.	Page Page	OEM OEM	Réf. Ref.	Page Page	OEM OEM	Réf. Ref.	Page Page	OEM OEM	Réf. Ref.	Page Page
USMW0165	130-198	133,135	U7LW0148	131-197	134	V836339723	131-200	135	ZZ90148	1-1	11,18
USMW0178	130-194	133,135,137	U7LW0149	131-90	137	V836340066	100-84	119	ZZ90150	1-5	11,18
USMW0179	130-198	133,135	U7LW0151	131-91	134	V836340257	131-200	135	ZZ90151	1-26	11,18
USMW0183	130-48	134	U7LW0156	131-13	133,139	V836354611	117-159	127	ZZ90165	1-32	15,17
USMW0188	130-71	133,136	U7LW0157	131-198	133,135,137	V836362023	100-85	119	ZZ90175	1-32	15,17
USMW0189	130-194	133,135,137	U7LW0158	131-198	133,135,137	V836639957	117-170	127	ZZ90179	1-77	11
USMW0190	130-198	133,135	U7LW0161	131-198	133,135,137	V836640073	33-174	48,56	ZZ90183	1-78	11
USPR0002	32-8	43,44,51	U7LW0170	131-8	132-139	V836640078	34-174	48,59	ZZ90196	1-29	15,17
USPR0011	32-78	47,50	U7LW0173	131-198	133,135,137	V836646271	28-27	37	ZZ90202	1-42	14,17
USPR0013	32-108	46,48,50,52	UAB104	925-1	410	V836646356	42-52	65,77			
USPR0015	32-108	46,48,50,52	UCB100	919-80	409	V836646357	43-52	65,77			
USPR0016	32-109	47,50	UCB109	919-81	409	V836646360	74-123	87			
USPR0025	32-74	45,49,50,52	UEB100	921-8	410	V836646380	45-52	73			
USPR0040	32-108	46,48,50,52	UIB100	922-11	410	V836646382	46-52	73			
USPR0045	32-59	46	ULB105	923-2	410	V836647304	41-52	65			
USPR0054	32-173	46,48,50,52	ULB110	923-1	410	V836647420	35-174	48,57			
USTW0002	6-3	12-15,17-19	ULPK0001	100-10	117,118,120	V836647502(2x)	37-174	48			
USTW0002B	6-4	12-15,17-19	ULPK0002	100-25	118,120	V836647503	37-174	48			
USTW0003	6-1	11,12,18,19	ULPK0003	100-8	117,118,120	V836647601	41-52	65			
USTW0003B	6-2	11,12,18,19	ULPK0004	100-19	117,120	V836655514	2-48	16			
USVK0111	39-4	60	ULPK0005	100-32	118,120	V836655536	2-48A	16			
USVK0120/0121	39-44	60	ULPK0006	100-4	117,120	V836655537	2-48B	16			
USVK0121	39-5	60	ULPK0007	100-9	118,120	V836659580	100-83	119			
USVK0130	39-8	60	ULPK0008	100-71	117,120	V836662111	97-33	179-181,187			
USVK0131	39-2	60	ULPK0009	100-5	117,119,120	V836664155	73-123	87			
USVK0131	39-8	60	ULPK0010	100-6	117,118,120	V836840883	11-33	25			
USVK0140/0141	39-9	60	ULPK0011	100-7	117,118,120	V836852607	90-59	109			
USVK0141	39-3	60	ULPK0015	100-44	118	V836854792	117-160	127			
USVK0151	39-12	60	ULPK0017	100-17	117	V836854930	117-166	127			
USVK0161	39-15	60	ULPK0018	100-3	117,119,120	V836854937	117-165	127			
USVK0171	39-13	60	ULPK0022	100-72	118	V836855300	90-58	109			
USVK0181	39-40	60	ULPK0034	100-32	118	V836855603	147-30	149			
USVK0182	39-42	60	ULPR0002	101-31	118,120	V836859108	97-61	180,181			
USVK0191	39-41	60	ULPR0003	101-4	117,120	V836859262	144-300	149			
USVK0192	39-43	60	ULPR0004	101-5	117,118,120	V836864164	144-277	149			
USVK0201	39-18	60	ULPR0005	101-10	117,118,120	ZZ80015	40-6	62,66,67,69			
U7LW0003	131-12	132	ULPR0006	101-3	117,120	ZZ80025	40-3	61,68			
U7LW0006	131-8	132-139	USB103	913-1	410	ZZ80033	40-5	62,69			
U7LW0009	131-10	136	USB104	913-2	410	ZZ80047	40-4	62,69			
U7LW0015	131-32	134	UTB107	915-1	410	ZZ80048	40-1	61,68			
U7LW0024	131-48	134	UTB110	914-1	410	ZZ80054	40-6	62,66,67,69			
U7LW0025	131-6	132,136	UVB102	912-2	410	ZZ80058	40-1	61,68			
U7LW0027	131-4	132,138	UVB104	912-1	410	ZZ80062	40-6	62,66,67,69			
U7LW0029	131-8	132-139	UWB102	911-2	410	ZZ80068	40-6	62,66,67,69			
U7LW0030	131-31	133,137,139	V614105880	11-32	25	ZZ80072	40-6	62,66,67,69			
U7LW0032	131-174	132,136,139	V614400002	13-35	25	ZZ80079	40-6	62,66,67,69			
U7LW0037	131-91	134	V614500002	13-35	25	ZZ80082	40-3	61,68			
U7LW0042	131-8	132-139	V685121905	144-277	149	ZZ80089	40-4	62,69			
U7LW0043	131-8	132-139	V835322233	37-175	48	ZZ80175	40-6	62,66,67,69			
U7LW0044	131-2	131,138	V835331864	931-10	423	ZZ80235	40-3	61,68			
U7LW0045	131-4	132,138	V835336903(2x)	37-175	48	ZZ90009	25-3	33-36,38-40			
U7LW0053	131-8	132-139	V835340017	100-82	119	ZZ90010	25-2	32,33,39,40			
U7LW0054	131-174	132,136,139	V836006574	44-51	73	ZZ90011	25-1	32,33,39,40			
U7LW0055	131-13	133,139	V836006578	46-51	73	ZZ90013	25-11	33-36,38-40			
U7LW0058	131-8	132-139	V836015156	143-56	149	ZZ90019	1-5	11,18			
U7LW0059	131-31	133,137,139	V836110153	42-51	65,77	ZZ90020	1-2	12,18			
U7LW0060	131-49	134,137	V836110552(x6)	3-48	16	ZZ90023	1-1	11,18			
U7LW0068	131-174	132,136,139	V836110646	28-28	37	ZZ90032	6051-2	78,80,81			
U7LW0071	131-90	137	V836112762(x6)	3-48A	16	ZZ90039	79-1	93			
U7LW0075	131-2	131,138	V836112763(x6)	3-48B	16	ZZ90044	14-3	22,24,26,27,29			
U7LW0076	131-4	132,138	V836115179	60-2	116	ZZ90047	6051-1	78,81			
U7LW0078	131-8	132-139	V836117564	43-51	65,77	ZZ90078	1-5	11,18			
U7LW0079	131-31	133,137,139	V836117910	45-51	73	ZZ90079	1-8	13,17,18			
U7LW0080	131-49	134,137	V836119457	2-48	16	ZZ90080	1-8	13,17,18			
U7LW0085	131-174	132,136,139	V836119459	6-30	16	ZZ90081	1-7	12-14,17,18			
U7LW0087	131-91	134	V836120326(7x)	2-48A	16	ZZ90082	1-8	13,17,18			
U7LW0092	131-4	132,138	V836120327(7x)	2-48B	16	ZZ90083	1-8	13,17,18			
U7LW0095	131-8	132-139	V836122443	73-122	87	ZZ90084	1-1	11,18			
U7LW0096	131-31	133,137,139	V836136051	41-51	65	ZZ90085	1-72	15			
U7LW0097	131-49	134,137	V836136342	97-33	179-181,187	ZZ90086	1-32	15,17			
U7LW0100	131-174	132,136,139	V836322183	75-122	87	ZZ90087	1-72	15			
U7LW0101	131-4	132,138	V836322243	90-59	109	ZZ90093	1-4	12,17			
U7LW0104	131-2	131,138	V836322898	74-122	87	ZZ90104	1-26	11,18			
U7LW0105	131-2	131,138	V836328734	43-51	65,77	ZZ90105	1-32	15,17			
U7LW0110	131-8	132-139	V836328735	42-51	65,77	ZZ90108	1-4	12,17			
U7LW0114	131-13	133,139	V836329632	147-29	149	ZZ90111	1-34	12,18			
U7LW0118	131-10	136	V836336297	28-26	37	ZZ90113	1-29	15,17			
U7LW0123	131-48	134	V836336459	97-34	179,187	ZZ90116	1-1	11,18			
U7LW0127	131-32	134	V836338187	90-57	109	ZZ90121	1-2	12,18			
U7LW0128	131-88	134	V836338606	28-32	37	ZZ90122	1-5	11,18			
U7LW0146	131-198	133,135,137	V836339087	117-137	127	ZZ90141	1-32	15,17			
U7LW0147	131-198	133,135,137	V836339201	34-175	48,59	ZZ90143	1-73	14			

Les références des pièces sont indicatives.
Nos pièces ne sont pas d'origine

Part numbers are quoted for reference purposes only.
Our parts and accessories are not original.



"THE RELIABLE SERVICE"



INDEX DES REFERENCES
REFERENCE INDEX

Réf. Ref.	Page Page	Réf. Ref.	Page Page	Réf. Ref.	Page Page	Réf. Ref.	Page Page	Réf. Ref.	Page Page	Réf. Ref.	Page Page
1-1	11, 18	3-1C	11, 18	11-32	25	30-111S	41	31-176S	54	33-174	48, 56
1-2	12, 18	3-1D	11, 18	11-33	25	30-112	41	31-177S	43	33-176	47, 52, 54, 56
1-4	12, 17	3-1E	11, 18	11-34	26	30-112S	41	31-178S	43	33-177	43, 56
1-5	11, 18	3-1F	11, 18	12-3	22, 23, 26, 28-30	30-113	41	31-179	46	33-178	43, 56
1-7	12-14, 17, 18	3-2	12, 18	12-4	24, 27	30-113S	41	31-183	46, 53	33-179	46, 56
1-8	13, 17, 18	3-2A	12, 18	12-10	20, 28	30-114S	42	31-183S	53	33-182	46, 50, 52, 56
1-26	11, 18	3-2B	12, 18	12-11	22, 23	30-115	42	31-200S	49	33-183	46, 53, 56
1-29	15, 17	3-2C	12, 18	12-12	24, 27	30-115S	42	31-201S	49	34-1	44, 58
1-32	15, 17	3-2D	12, 18	12-15	25, 28, 30	30-116	42	31-202S	49	34-2	44, 51, 58
1-34	12, 18	3-2F	12, 18	12-16	23, 26	30-116S	42	31-203S	49	34-3	43, 44, 53, 58
1-42	14, 17	3-3	12-14, 17, 18	12-17	93	30-117	42	32-1	44	34-4	43, 44, 51, 58
1-72	15	3-3A	12-14, 17, 18	12-18	23	30-117S	42	32-2	44, 51	34-7	43, 44, 51, 53, 58
1-73	14	3-3B	12-14, 17, 18	13-1	20, 21, 28, 29	30-118	42	32-3	43, 44	34-8	43, 44, 51, 53, 58
1-77	11	3-3C	12-14, 17, 18	13-2	22-24, 26, 27, 29	30-118S	42	32-4	43, 44, 51	34-9	45, 49, 51, 53, 58
1-78	11	3-3D	12-14, 17, 18	13-3	20-24, 26-29	30-119	42	32-5	43, 44, 51	34-10	45, 51, 58
2-1	11, 18	3-3E	12-14, 17, 18	13-4	20-30	30-119S	42	32-6	44, 51	34-11	43, 51, 58
2-1A	11, 18	3-3F	12-14, 17, 18	13-5	21	30-181S	41	32-7	43, 44, 51	34-12	45-55, 58
2-1B	11, 18	3-4	15, 17	13-13	21, 29	30-182	42	32-8	43, 44, 51	34-12C	55
2-1C	11, 18	3-4A	15, 17	13-21	21	30-182S	42	32-9	45, 49, 51	34-12T	47, 58
2-1D	11, 18	3-4B	15, 17	13-35	25	30-183	42	32-10	45, 51	34-13	46, 49, 53, 58
2-1E	11, 18	3-4C	15, 17	14-1	20, 21, 28, 29	30-183S	42	32-11	43, 51	34-16	44, 58
2-1F	11, 18	3-4D	15, 17	14-3	22, 24, 26, 27, 29	30-184	42	32-12	45, 49, 55	34-18	47, 55, 58
2-2	12, 18	3-4E	15, 17	15-1	32-34, 38-40	30-184S	42	32-12C	55	34-18C	55
2-2A	12, 18	3-4F	15, 17	15-5	34, 35, 38, 40	30-185	42	32-13	46, 49	34-20	49, 58
2-2B	12, 18	3-10	12	15-7	35-37	30-185S	42	32-16	44	34-21	46, 52, 58
2-2C	12, 18	3-10A	12	15-13	32-34	30-186	42	32-18	47, 55	34-23	47, 50, 58
2-2D	12, 18	3-10B	12	15-14	35, 38, 39	30-186S	42	32-18C	55	34-24	47, 54, 55, 58
2-2F	12, 18	3-10C	12	15-15	33, 40	31-1	44	32-20	49	34-24A	55
2-3	12-14, 17, 18	3-11	13, 17, 18	15-16	35, 36	31-2	44, 50	32-21	46, 52	34-40	44, 58
2-3A	12-14, 17, 18	3-11A	13, 17, 18	16-1	32-36, 38-40	31-3	43, 44, 53	32-22	47, 50, 55	34-41	44, 58
2-3B	12-14, 17, 18	3-11B	13, 17, 18	17-1	20, 21, 28, 29	31-3S	53	32-22C	55	34-57	46, 49, 52, 53, 58
2-3C	12-14, 17, 18	3-11C	13, 17, 18	17-2	21, 29	31-4	43, 44, 51	32-23	47, 50	34-59	46, 58
2-3D	12-14, 17, 18	3-18	12	17-3	22, 24, 26, 27, 29	31-5	43, 44, 51, 53	32-24	47	34-71	43, 51, 58
2-3E	12-14, 17, 18	3-18A	12	17-4	20, 21, 28, 29	31-5S	53	32-40	44	34-72	43, 51, 58
2-3F	12-14, 17, 18	3-18B	12	17-5	22-30	31-6	44, 51	32-41	44	34-74	45, 49-53, 58
2-4	15, 17	3-18C	12	17-9	23, 30	31-7	43, 44, 51, 53	32-57	46, 49, 52	34-75	47, 50, 54, 58
2-4A	15, 17	3-19	12	17-15	23, 26	31-7S	53	32-59	46	34-78	45-50, 54, 58
2-4B	15, 17	3-19A	12	18-1	31	31-8	43, 44, 51, 53	32-69	45, 49, 50, 52	34-90	48, 52, 59
2-4C	15, 17	3-19B	12	21-17	31	31-8S	53	32-72	43, 51	34-108	46-54, 59
2-4D	15, 17	3-19C	12	21-19	31	31-9	45, 51, 53	32-73	45, 49	34-110	47, 50, 52, 59
2-4E	15, 17	3-19D	12	21-22	31	31-9S	53	32-74	45, 49, 50, 52	34-173	46-54, 59
2-4F	15, 17	3-19E	12	21-25	31	31-10	45, 51	32-77	47, 50	34-174	48, 59
2-10	12	3-19F	12	21-32	31	31-11	43, 51	32-78	47, 50	34-175	48, 59
2-10A	12	3-20	12, 18	21-35	31	31-12	45	32-108	46, 48, 50, 52	34-176	47, 52, 54, 59
2-10B	12	3-20A	12, 18	21-38	31	31-13S	46, 49	32-109	47, 50	34-177	43, 59
2-10C	12	3-20B	12, 18	21-50	31	31-14	45, 52, 53	32-173	46, 48, 50, 52	34-178	43, 59
2-11	13, 17, 18	3-20C	12, 18	22-32	31	31-14S	53	32-174	48	34-182	46, 50, 52, 59
2-11A	13, 17, 18	3-20F	12, 18	22-35	31	31-15	46, 53	32-176	47, 52	34-183	46, 53, 59
2-11B	13, 17, 18	3-28	14, 17, 18	22-38	31	31-15S	53	32-177	43	35-1	44, 57
2-11C	13, 17, 18	3-28A	14, 17, 18	25-1	32, 33, 39, 40	31-16	44	32-178	43	35-2	44, 51, 57
2-18	12	3-28B	14, 17, 18	25-2	32, 33, 39, 40	31-18	47	32-179	46	35-3	43, 44, 57
2-18A	12	3-28C	14, 17, 18	25-3	33-36, 38-40	31-20	49	32-182	46, 50, 52	35-4	43, 44, 51, 57
2-18B	12	3-29	15, 17	25-11	33-36, 38-40	31-21	46, 52	32-183	46	35-7	43, 44, 51, 57
2-20	18	3-29A	15, 17	26-1	32, 33, 39, 40	31-23	47, 50	33-1	44, 56	35-14	45, 47, 49-52, 57
2-20A	18	3-29B	15, 17	26-2	33-36, 38-40	31-24	47	33-2	44, 51, 56	35-15	46, 49, 50, 52, 57
2-20B	18	3-29C	15, 17	26-13	34, 36, 39, 40	31-39S	50	33-3	43, 44, 53, 56	35-16	44, 57
2-20C	18	3-48	16	27-1	32, 33, 39, 40	31-40	44	33-4	43, 44, 51, 53, 56	35-20	49, 57
2-20D	18	3-48A	16	27-2	33-36, 38-40	31-41	44	33-5	43, 44, 51, 56	35-21	46, 52, 57
2-20E	18	3-48B	16	28-1	32, 33, 39, 40	31-57	46, 49, 52, 53	33-7	44, 51, 53, 56	35-22	45, 49, 50, 52, 57
2-20F	18	3-76	11, 18	28-2	33-36, 38-40	31-57S	53	33-8	43, 44, 51, 53, 56	35-23	46, 49, 52, 57
2-29	15, 17	3-76A	11, 18	28-3	33	31-58	46, 49, 52, 53	33-9	45, 49, 51, 53, 56	35-40	44, 57
2-29A	15, 17	3-76B	11, 18	28-8	34, 38, 40	31-58S	53	33-10	45, 51, 56	35-41	44, 57
2-29B	15, 17	3-76C	11, 18	28-16	33-36, 38-40	31-59	46	33-11	43, 51, 56	35-108	46-48, 50, 52, 57
2-29C	15, 17	4-1	19	28-26	37	31-60	45, 49	33-12	45, 49, 55, 56	35-173	46, 48, 50, 52, 57
2-45	15	4-2	19	28-27	37	31-69	45, 50, 52, 53	33-12C	55	35-174	48, 57
2-45A	15	4-3	19	28-28	37	31-69S	53	33-13	46, 49, 53, 56	36-3	43, 44, 53, 57
2-45B	15	4-4	19	28-32	37	31-70	47, 50, 54	33-16	44, 56	36-7	43, 44, 51-57
2-45C	15	5-1	19	28-33	33, 40	31-70S	54	33-18	47, 50, 54-56	36-7A	55
2-48	16	5-2	19	28-40	36	31-72S	43	33-18C	55	36-7C	55
2-48A	16	5-3	19	28-41	34, 36, 39, 40	31-73	45, 49	33-20	49, 56	36-7E	55
2-48B	16	5-4	19	30-100	41	31-74	45, 49, 50, 52, 53	33-21	46, 52, 56	36-7K	55
2-52	15	6-1	11, 12, 18, 19	30-101	41	31-74S	53	33-23	47, 50, 56	36-13	46, 49, 50, 57
2-52A	15	6-2	11, 12, 18, 19	30-101S	41	31-77	47, 50, 54	33-24	47, 54, 56	36-14	45, 47, 49-54, 57
2-52B	15	6-3	12-15, 17-19	30-102	41	31-77S	54	33-40	44, 56	36-15	46, 49-53, 57
2-52C	15	6-4	12-15, 17-19	30-102S	41	31-78	47, 50, 54	33-41	44, 56	36-18	49, 50, 54, 57
2-76	11, 18	6-13	12	30-103	41	31-78S	54	33-57	46, 49, 52, 53, 56	36-21	46, 52, 57
2-76A	11, 18	6-30	16	30-103S	41	31-79S	54	33-59	46, 56	36-22	45, 49-53, 57
2-76B	11, 18	11-1	20, 21, 28, 29	30-105S	41	31-81S	43	33-69	45, 49-53, 56	36-23	46, 49, 52, 53, 57
2-76C	11, 18	11-2	22, 24, 26, 27, 29	30-106	41	31-108	46, 48, 50, 52, 54	33-72	43, 51, 56	36-24	43, 57
2-77	11	11-3	22, 24, 26, 27, 29	30-107	41	31-108S	54	33-73	45, 49, 56	36-108	46-54, 57
2-77A	11	11-10	20, 21, 28, 29	30-107S	41	31-109	47, 50	33-74	45, 49, 53, 56	36-173	46-54, 57
2-77B	11	11-11	22-30	30-108	41	31-140	43, 50	33-77	47, 50, 54, 56	36-177	43, 57
2-77C	11	11-12	21	30-108S	41	31-173	46, 48, 50, 52, 54	33-78	47, 50, 54, 56	37-174	48
3-1	11, 18	11-13	23, 26, 30	30-110	41	31-173S	54	33-108	46-56	37-175	48
3-1A	11, 18	11-15	21, 29	30-110S	41	31-174	48	33-109	47, 50, 56	39-2	60
3-1B	11, 18	11-21	21	30-111	41	31-176	47, 52, 54	33-173	46-56	39-3	60

Les références des pièces sont indicatives.
Nos pièces ne sont pas d'origine

Part numbers are quoted for reference purposes only.
Our parts and accessories are not original.



INDEX DES REFERENCES
REFERENCE INDEX

Réf. Ref.	Page Page	Réf. Ref.	Page Page	Réf. Ref.	Page Page	Réf. Ref.	Page Page	Réf. Ref.	Page Page	Réf. Ref.	Page Page	Réf. Ref.	Page Page
39-4	60	43-60	61.77	71-35	85,88	75-109	83,90	92-11	111	108-17	125		
39-5	60	43-61	63,64,77	71-52	83,84,88-90	75-110	85,88	93-1	112,113	108-18	124		
39-8	60	43-62	63,64,67,69,77	71-53	83,88-90	75-111	83,90	93-2	112,113	108-19	125		
39-9	60	43-63	63,67,69,77	71-59	85,88	75-113	86	93-10	114,115	108-20	123		
39-12	60	44-1	71	71-81	82	75-120	83	94-2	112,113	108-21	124		
39-13	60	44-2	71.76	71-82	84,85,89,90	75-121	84,90	94-3	112,113	108-22	124		
39-15	60	44-3	70,71,75,76	71-83	85,89	75-122	87	94-4	112,113	108-23	124		
39-16	60	44-4	71-76	71-90	84,89,90	79-1	93	94-5	112,113	108-24	125		
39-18	60	44-51	73	71-91	86	80-1	94, 102	94-6	112,113	108-25	123		
39-40	60	44-67	71-76	71-107	82	80-4	95-104	94-11	114,115	108-26	123		
39-41	60	45-1	71	71-108	83	80-6	94,102	95-1	192	108-32	123		
39-42	60	45-2	71.76	71-109	86	80-7	95-104	96-1	173	108-33	123		
39-43	60	45-3	70,71,75,76	71-115	86	80-11	99	96-2	173-175,182	108-34	123		
39-44	60	45-4	71-76	72-1	83	80-12	97,102,104	96-3	173-177,182-187	108-35	123		
40-1	61.68	45-11	71	72-2	83,90	80-13	96,100,102,103	96-4	186,187	108-36	124		
40-3	61.68	45-17	70	72-5	82,89	81-1	94,102	96-15	186	108-37	124		
40-4	62.69	45-51	73	72-6	83,90	81-2	95,103	97-1	174-177,182-188	108-38	124		
40-5	62.69	45-52	73	72-9	83,90	81-3	95-104	97-2	175-188	108-39	124		
40-6	62,66,67,69	45-60	70,75	72-10	83,84,89,90	81-4	93	97-3	177-180,185-187	108-40	124		
41-1	62.69	45-61	71-76	72-12	85,88	81-10	95-104	97-33	179-181,187	108-41	124		
41-2	62.69	45-62	72,73,76	72-19	83	81-12	95-100,102-104	97-34	179,187	108-42	124,125		
41-3	61,62,68,69	45-63	72,73,75,76	72-20	83	81-13	94	97-43	175	108-43	124		
41-8	63,66,69	45-64	72,75,76	72-30	83	81-14	95-100,102-104	97-61	180,181	108-44	125		
41-9	62	46-1	70,71,75,76	72-31	84,90	82-1	94,102	98-1	192	108-45	125		
41-10	62	46-2	71-76	72-51	83,84	82-2	95,103	98-2	192	108-46	125		
41-17	62-69	46-13	70	72-57	85,88	82-3	95,103	99-1	112,113	108-47	125		
41-18	62-69	46-14	72,73,75,76	72-90	89	82-4	95-104	100-1	117	108-48	125		
41-19	61.68	46-51	73	72-91	86	82-10	98,101	100-2	117,120	108-49	125		
41-20	61,62,68	46-52	73	72-105	82	82-11	98,101	100-3	117,119,120	108-50	125		
41-51	65	47-1	71-76	72-106	86	82-12	95-104	100-4	117,120	108-51	125		
41-52	65	47-1S	71-76	72-107	82	82-13	94,102	100-5	117,119,120	108-52	125		
41-60	61	47-2	73,74	72-113	84,85,88,90	82-14	95-97	100-6	117,118,120	108-53	125		
41-61	63,64,67,69	47-7	71	72-114	84,85	82-15	95,103	100-7	117,118,120	108-54	125		
41-62	63,64,67,69	47-60	70,71,75	73-1	83	82-16	99	100-8	117,118,120	108-55	125		
42-1	62.77	47-63	72,73,75,76	73-2	83,90	83-1	95-100,102-104	100-9	118,120	108-56	125		
42-2	62,69,77	47-64	72,75,76	73-3	82,89	83-2	98,100	100-10	117,118,120	109-1	130		
42-3	61,62,68,69,77	47-65	72,73,75,76	73-4	82,89	83-3	94,102	100-17	117	109-2	130		
42-4	61,62,68,69,77	47-66	70	73-4A	82,89	84-5	108,111	100-19	117,120	109-3	130		
42-5	61,62,68,77	47-67	71,74,75,76	73-6	83	84-7	94,102	100-25	118,120	109-4	130		
42-6	62,66,67,69,77	50-4	78,81	73-7	83,90	84-8	95-104	100-32	118,120	110-16R	130		
42-6A	77	50-5	78,81	73-8	83,90	84-9	98,100	100-44	118	110-17R	130		
42-6B	77	50-6	78,79,80,81	73-11	83,84,88,90	84-10	98,100	100-71	117,120	110-18T	130		
42-6C	77	50-7	78,79,80,81	73-12	85,88	84-11	99,108,110,111	100-72	118	110-19	130		
42-9	62-69,77	53-2	78,79,80,81	73-19	83	85-2	106	100-82	119	110-301	130		
42-9A	77	54-2	78,81	73-20	83	85-3	106	100-83	119	110-301R	130		
42-9B	77	54-3	78,79,80,81	73-30	83	85-12	106	100-84	119	110-302	130		
42-9C	77	55-2	155-157,160-164	73-31	84,90	85-13	106	100-85	119	110-302R	130		
42-15	62.77	55-5	107	73-35	85,88	86-1	107	101-3	117,120	111-1	173,187		
42-16	63,66,69,77	56-1	95-104	73-52	83,84,88-90	86-2	107	101-4	117,120	111-2	173		
42-19	62.77	57-1	200	73-53	83,84,88-90	86-5	107	101-5	117,118,120	111-3	130,173-188		
42-20	62.77	58-1	200	73-56	85,88	88-1	107	101-7	117,118,120	111-4	176-181,186-188		
42-24	61,68,77	58-2	200	73-83	85,89,90	89-1	112,113	101-10	117,118,120	111-5	130,173-188		
42-25	62,66,67,69,77	58-7	200	73-90	84,85,89,90	89-2	112,113	101-31	118,120	111-6	176-181,186-188		
42-26	61,68,77	58-8	200	73-91	86	89-3	112,113	101-43M	119	111-8	187		
42-27	61,68,77	58-18	200	73-107	82	89-4	112,113	101-57	119	111-25	178,180,185,186		
42-38	63,64,67,69,77	59-1	399,406	73-122	87	89-5	114,115	101-58	119	111-63	178-180,185,186		
42-39	63,64,67,69,77	60-1	116	73-123	87	89-6	114,115	102-1	119	111-202	180,181		
42-51	65.77	60-2	116	74-1	83	90-1	108,111	103-1	122	112-1	130		
42-52	65.77	60-3	116	74-2	83	90-2	108,111	103-2	122	112-2	130		
42-60	61.77	60-22	116	74-3	83	90-3	108,110,111	103-3	122	113-1	129		
42-61	63,64,77	60-23	116	74-4	83,90	90-4	110	103-4	122	114-1	129		
42-62	63,64,67,69,77	61-3	116	74-5	82,89	90-5	109,110	103-14	122	117-3	126,128		
42-63	63,67,69,77	65-1	168	74-6	83,90	90-6	112,113	104-1	122	117-4	126,128		
42-71	64	65-2	168	74-7	83	90-11	108	104-3	122	117-6	126,128		
43-1	62.77	65-3	168	74-8	82,89	90-12	108,110	105-1	122	117-8	126,128		
43-2	62,69,77	65-5	168	74-9	83,90	90-13	108-115	105-2	122	117-9	126,128		
43-3	61,62,68,69,77	65-6	168	74-11	83,84,88-90	90-14	109,110	105-6	122	117-10	126,128		
43-4	61,68,69,77	65-7	168	74-13	84,90	90-15	114,115	105-7	122	117-12	126,128		
43-5	61,62,68,77	66-1	168	74-15	85,88	90-16	114,115	105-19	122	117-31	126		
43-6	62,66,67,69,77	66-2	168	74-17	85,88	90-17	114,115	105-20	122	117-32	126,128		
43-6A	77	66-3	168	74-32	85,88	90-18	114,115	106-2	121	117-34	126,128		
43-6B	77	71-1	83	74-90	84	90-23	109,110	107-3	123	117-35	126,128		
43-6C	77	71-2	83,90	74-91	86	90-51	109	107-4	123	117-36	126,128		
43-9	62-69,77	71-3	82,89	74-105	84,89,90	90-52	110,111	107-5	123	117-37	126,128		
43-9A	77	71-5	82,89	74-106	86	90-53	110,111	107-22	123	117-38	128		
43-9B	77	71-6	83	74-107	82	90-54	109	107-23	123	117-39	127,128		
43-9C	77	71-7	83,90	74-108	84,85,89,90	90-55	110	108-1	123	117-41	127,128		
43-15	62.77	71-8	83,90	74-109	86	90-57	109	108-2	123	117-42	126,127		
43-16	63,66,69,77	71-9	82,89	74-122	87	90-58	109	108-3	123	117-43	127,128		
43-19	62.77	71-10	83,84,88,90	74-123	87	90-59	109	108-4	124	117-62	128		
43-20	62.77	71-12	85,88	75-4	82,89	91-1	108,111	108-5	124	117-96	126		
43-24	61,62,68,77	71-19	83	75-105	82,89	91-2	108,111	108-7	125	117-135	126-128		
43-26	63-69,77	71-20	83	75-106	83-85,88-90	91-3	108,110,111	108-8	125	117-136	126		
43-27	61,68,77	71-30	83	75-107	83	92-3	112,113	108-9	125	117-137	127		
43-51	65.77	71-31	84,90	75-108	83,90	92-4	112,113	108-15	125	117-146	126,128		
43-52	65.77	71-34	85			92-10	111	108-16	125	117-147	127		

Les références des pièces sont indicatives.
Nos pièces ne sont pas d'origine

Part numbers are quoted for reference purposes only.
Our parts and accessories are not original.



"THE RELIABLE SERVICE"



INDEX DES REFERENCES
REFERENCE INDEX

Réf. Ref.	Page Page	Réf. Ref.	Page Page	Réf. Ref.	Page Page	Réf. Ref.	Page Page	Réf. Ref.	Page Page	Réf. Ref.	Page Page
117-148	127	131-174	132,136,139	144-226	144	150-2	155	153-136	159,165	154-250	164
117-149	126	131-197	134	144-227	145,148	150-3	155	153-137	159,165	158-5	191
117-150	127	131-198	133,135,137	144-228	145,146	150-4	155,164	153-138	158,159,165	158-6	191
117-151	126-128	131-200	135	144-229	143,150,151,153	150-8	155	153-139	159,165	159-4	191
117-152	127	141-1	132,140	144-230	141,152	150-9	155,164	153-140	158,165	159-5	191
117-153	127	141-2	132,138,140	144-231	147	150-10	155,164	153-143	157,159,165	159-6	191
117-154	126,127	141-3	131,138,140	144-232	142	150-12	156,157,164	153-218	160,165	160-1	191
117-155	126	141-4	132,138,140	144-233	144	150-13	157,160	153-219	163,165	160-2	191
117-156	127	141-10	133,140	144-234	144	150-14	157	153-227	155,165	160-3	191
117-157	127	141-11	133, 137, 139, 140	144-235	147	150-15	155,160,164	153-228	156,165	160-4	191
117-158	127	141-12	134,140	144-236	147	150-16	156,157,164	153-229	156,165	160-5	191
117-159	127	141-32	132,140	144-237	145	150-17	160,164	153-230	156,165	160-6	191
117-160	127	141-60	134,137,140	144-238	142	150-19	156	153-231	156,165	161-1	174
117-161	126	141-61	137,140	144-239	144	150-49	160	153-232	156,165	161-3	175,188
117-162	126,128	141-62	137,140	144-240	144	150-57	157	153-233	157,165	161-12	175,177,188
117-163	126	141-63	135,140	144-241	149	150-58	157,159	153-234	158,166	161-13	176,177
117-164	127	141-64	132,138,140	144-242	148	150-59	158,159	153-235	158,166	161-14	176,177
117-165	127	141-65	133,136,140	144-243	146,149	150-60	158	153-236	160-163,166	161-22	176
117-166	127	141-66	132	144-244	146	150-61	158,159	153-237	160,161	161-23	176
117-167	128	141-131	133,139,140	144-245	146,149	150-76	155	153-238	162,166	161-24	176,188
117-168	128	141-132	133,135,137,140	144-246	146	150-81	157	153-239	163,166	161-25	177,178,180
117-170	127	141-133	134,137,140	144-247	145	150-82	158	153-240	163,166	161-26	178
118-1	129	142-1	131,138,140	144-248	145	150-83	157	153-241	160,161	161-27	178-180
118-2	129	142-2	132,138,140	144-249	148	150-89	155	154-1	155,166	161-38	186,187
120-2	105	142-3	133,140	144-250	148	150-90	155	154-2	155,166	161-41	187
121-1	105	142-8	131,138,140	144-251	145	150-91	156,157	154-3	155,166	161-60	177,185,187
122-1	105	142-9	133,140	144-252	146	150-92	156	154-4	155,164,166	161-63	174
123-1	105	142-16	134,140	144-253	146	150-93	156	154-5	155,164,166	161-77	179,180,187
124-1	105	142-17	133,139,140	144-254	146	150-94	157	154-6	155,166	161-78	176,177,188
124-2	105	142-30	134,140	144-255	152	150-106	155	154-7	155,164,166	161-86	186
125-1	129	142-31	134,140	144-256	149	150-110	159	154-8	155,166	161-95	177
125-2	129	143-2	142,151,153	144-257	145	150-112	160,162	154-9	155-157,164,166	161-97	177
126-2	129	143-3	141,147,150,153	144-258	147	150-113	161,163	154-10	155-157,166	161-98	175,177
127-1	129	143-4	142,147,150,153	144-259	151	150-114	160,163	154-11	157,164,166	161-99	176,177,182
127-2	129	143-5	142,144,150,153	144-260	151	150-115	162,163	154-38	156,166	161-100	174
127-3	129	143-18	141,142,144,153	144-261	151,153	150-116	160,163	154-39	156,166	161-104	178,180,184,185
127-5	129	143-55	145-149,151-153	144-262	142	150-117	161,163	154-40	156,166	161-105	185
127-6	129	143-56	149	144-263	142	150-119	162,163	154-41	156,166	161-118	179,186
127-7	129	143-57	142	144-264	142	150-120	163	154-43	157,166	161-119	179,180,186
127-8	129	143-60	149	144-265	145	150-121	163	154-44	158,166	161-120	179,180
130-1	132,138	144-1	142,151,153	144-266	143	150-122	163	154-45	158,166	161-121	180,181
130-2	131,138	144-2	141,142,151-153	144-267	142,144,147,148	150-123	163	154-64	157,166	161-124	181
130-3	131,138	144-3	141,142,151-153	144-268	150	150-124	163	154-66	156,157,166	161-125	180
130-4	132,138	144-4	141,142,143,150	144-269	145	150-125	161,163	154-69	157,158,166	161-126	181
130-6	131,138	144-5	141,152	144-270	145,146,148,149	150-126	162,163	154-113	155,166	161-127	181
130-8	132,136,137,139	144-6	143,144,151,153	144-271	148	150-128	159	154-114	155,156,157,166	161-141	185
130-10	136	144-13	145,147	144-272	148	150-129	158	154-115	163,166	161-142	182-184
130-12	132	144-21	141-145,151-153	144-273	150	151-1	155	154-126	162,163	161-143	183-185
130-13	133	144-22	143,144,151,153	144-274	151,153	151-2	155,164	154-130	158,159,166	161-153	184
130-14	133,139	144-29	141-144,152	144-275	145	151-3	155,164	154-131	158,159,166	161-165	181
130-31	133,137,139	144-30	141,142,144	144-277	149	151-8	155,156,157,164	154-132	159,166	162-1	174
130-32	134	144-31	144	144-279	152	151-14	155-159	154-133	158,159,166	162-3	175,188
130-48	134	144-33	147	144-288	146	151-15	157,158	154-134	159,166	162-12	175,177,188
130-49	134,137	144-34	143,144	144-290	144,145,147,149	151-19	157	154-135	159,166	162-13	176,177
130-71	133,136	144-35	144	144-292	146	151-29	160,163	154-136	158,159,166	162-14	176,177
130-88	134	144-36	147-149	144-293	146	153-1	155,165	154-137	158,166	162-22	176
130-90	137	144-37	147-149	144-294	145	153-2	155,165	154-138	159,166	162-23	176,188
130-91	134	144-100	141,143	144-295	145	153-3	155,165	154-139	158,167	162-25	177-187
130-136	132,138	144-101	146,147	144-296	148	153-6	155,165	154-209	160,167	162-26	178
130-137	132,136,139	144-102	147	144-297	151,153	153-7	155,164,165	154-210	160,167	162-27	178-180
130-193	134	144-103	148	144-298	147	153-8	155,165	154-211	160,167	162-41	187
130-194	133,135,137	144-123	148,149	144-299	145	153-9	155-157,164,165	154-212	163,167	162-64	185
130-196	137	144-124	148	144-300	149	153-11	155-157,164,165	154-213	160,167	162-77	179,180,187
130-197	134	144-125	147	144-301	149	153-37	164,165	154-215	163,167	162-78	176,177,188
130-198	133,135	144-126	144,145	145-5	154	153-38	156,165	154-227	155,167	162-97	177
130-199	134	144-127	148,149	145-6	154	153-39	156,165	154-228	155,167	162-98	175,177
130-213	132	144-128	141,143,150-153	145-7	154	153-40	156,165	154-229	155	162-99	176,177,182
131-1	132,138	144-129	149	145-8	154	153-41	156,165	154-230	156,167	162-118	179,186
131-2	131,138	144-204	147,150	145-9	154	153-43	157,165	154-231	156,167	162-119	179,180,186
131-2B	135	144-205	151	145-12	154	153-44	158,165	154-232	156,167	162-120	179,180
131-4	132,138	144-206	141,143	146-3	154	153-45	158,165	154-233	157,167	162-121	180,181
131-6	132,136	144-207	150	147-12	141,142,150,152	153-64	157,165	154-234	157,167	162-124	181
131-6S	135	144-208	144	147-13	142,151,153	153-65	157,165	154-236	158,167	162-125	180
131-8	132,133,136-139	144-209	145	147-14	143,144,150-153	153-66	156,157,165	154-237	158,159,167	162-126	181
131-8C	135	144-210	144	147-15	144-147,150-153	153-68	157,165	154-238	158,167	162-127	181
131-10	136	144-211	146-148	147-16	145,151,153	153-69	157,158	154-239	158,167	162-142	182-184
131-11	136	144-212	141,142,145,152	147-17	146,149	153-111	155-157,165	154-240	158,167	162-143	183-185
131-12	132	144-214	142	147-18	146,149,152	153-112	163,165	154-241	158,167	162-153	184
131-13	133,139	144-216	150,151	147-19	147,148,150,151	153-113	163,165	154-242	160,161,167	162-165	181
131-31	133,137,139	144-219	150,151	147-20	148,149	153-114	160,161,163,165	154-243	160-163,167	163-2	190
131-32	134	144-220	150,151	147-21	152	153-130	156,164,165	154-244	160,167	163-3	190
131-48	134	144-221	147-149	147-22	142,151,153	153-131	158,159,165	154-245	158,167	163-4	190
131-49	134,137	144-222	146,149	147-29	149	153-132	158,159,165	154-246	161,167	163-7	190
131-88	134	144-223	151-153	147-30	149	153-133	159,165	154-247	162,167	163-8	190
131-90	137	144-224	151,153	147-31	143,144	153-134	158,159,165	154-248	163,167	163-10	190
131-91	134	144-225	142,146,148	150-1	155	153					

INDEX DES REFERENCES
REFERENCE INDEX

Réf. Ref.	Page Page	Réf. Ref.	Page Page	Réf. Ref.	Page Page	Réf. Ref.	Page Page	Réf. Ref.	Page Page	Réf. Ref.	Page Page
163-13	190	172-7	194	181-41	210	200-253L	229	221-232	230	255-7	245-249
163-14	190	172-8	194	181-42	211	200-254L	224,229	221-270	230	255-8	246,247,248,249
163-23	190	172-9	194	181-44	210	200-255L	229	221-411	224	255-9	249,250,251,266
163-24	190	172-10	194	181-46	210	200-270	230	221-411L	224	256-1	245
163-46	190	172-11	194	181-47	210	200-271	230	221-412	224	256-2	245-249
163-47	190	172-12	194	181-49	210	200-272	223	221-412E	224	256-3	249,250,251,266
163-54	190	172-13	194	181-50	210	200-402L	224	221-412L	224	257-1	269
163-55	190	172-28	194	181-51	210	200-403L	224	222-1	238	257-2	269
163-58	190	172-30	194	181-52	211	200-405L	231	222-2	239	258-1	245,246,247,248
163-59	190	172-31	194	181-53	211	201-1	238	223-1	238,239	258-2	246,247,248
163-60	190	172-32	194	181-61	211	201-2	239	224-1	238	258-4	249,250
164-1	169	172-33	195	181-62	211	201-3	239	224-2	239	258-11	245,246,247,248
164-2	169	172-34	195	181-66	210	202-1	238	225-1	238	258-15	246,248
164-3	169	172-35	195	181-67	210	202-2	239	225-2	239	258-16	249,250,251,266
164-4	169	172-36	194	182-1	211	203-1	238	226-9	240	258-17	246,247,249
164-5	169	172-37	194	182-2	211	203-2	239	226-12	240	259-1	252,253
164-6	169	172-39	194	183-3	211	204-1	238	227-5	240	259-10	253,267
164-7	169	172-40	194	184-1	211	204-2	239	227-12	240	261-1	245,249,250,265
164-8	169	172-41	194	185-1	210,211	205-1	238,239	229-13	240	261-2	245-251,265,267
165-1	170	172-42	194	186-1	208	206-1	238,239	229-14	240	261-3	269
165-1S	170	172-43	195	186-13	208	206-2	238,239	230-1	218-223,225-231	262-2	252,253
165-2	170	172-44	195	186-14	208	207-1	238,239	230-24	224,229	262-10	253,267
165-2S	170	172-45	195	186-15	208	207-2	238,239	230-270	231	263-1	252
165-6	170	172-46	195	186-16	208	208-1	238,239	230-271	231	263-2	252,253
165-26	171	172-47	195	186-17	208	209-1	238,239	231-1	218-223,225-231	263-5	252,253
165-27	170	172-48	195	186-18	208	210-9	239	231-16	218-223,225-231	263-11	253,267
165-27PB	170	172-49	195	186-19	208	211-1	238	231-17	230	264-1	245-251,265,266
165-28	170	172-50	195	186-26	208	211-2	238	231-23	218	264-2	245-249
165-29	171	172-51	195	186-27	208	211-3	239	231-61	224,229	264-4	249,250
165-70	171	172-52	195	187-1	207	212-1	218,219,221,230	231-62	229	265-1	252
165-108	171	172-54	195	187-2	207	212-4	219,220,222	231-63	231	265-2	252
165-109	171	172-55	195	187-24	207	212-6	219-223,225-228	231-64	230	265-3	252
165-110	171	172-56	195	187-25	207	212-16	239	231-65	230	265-4	252
165-111	171	173-1	197	187-26	207	212-17	239	231-66	231	265-7	252,253
165-112	171	173-3	197	187-27	207	212-55	224	231-67	229	265-8	252
165-120	171	173-4	197	189-64	211	212-55E	224	231-68	224,229	265-19	253,267
165-121	171	174-1	196	189-65	211	212-55L	224	231-69	229	266-1	252,253,261-268
165-122	171	174-2	196	196-2	231	212-56	218	231-70	225-229,231	267-1	254
165-123	171	174-11	196	196-3	231	212-57	229	232-1	238	267-2	254
165-145	170	174-17	196	196-4	231	212-57L	229	232-2	239	268-1	254
165-146	170	175-1	198	196-5	231	212-58L	224	233-1	238,239	268-2	254
165-147	170	175-3	198	196-6	231	212-59	229	233-8	307	268-3	254
165-148	171	175-9	198	198-8	217	212-59L	229	233-9	307	268-4	254
165-155	171	175-12	198	198-9	217	212-270	230	233-10	240,308	269-1	254
165-156	171	175-13	199	198-10	217	214-1	238	234-1	240	269-2	254
165-157	170	176-1	198	198-11	217	214-2	239	235-1	240	269-3	254
166-13	172	176-3	198	198-12	217	215-5	238,239	236-1	240	269-4	254
166-14	172	176-4	198	198-13	217	216-1	238,239	240-7	177,186	270-1	254
166-15	172	176-9	198	198-14	217	217-1	238	240-22	185	270-2	254
166-16	172	176-10	198	198-15	217	217-2	239	240-23	185	271-2	254
166-17	172	176-11	198	198-16	217	218-1	238	240-24	185	272-3	267
166-18	172	176-12	198	198-17	217	218-2	239	240-25	176,182-184	272-4	267
167-1	169	176-13	199	199-3	217	219-1	238	240-26	185	273-1	254
167-2	169	176-14	199	200-1	218,219,230	219-2	238	240-27-2	185	273-2	254
167-3	169	176-15	199	200-1L	218,219,230	219-3	239	240-28	177,178	275-3	264
167-4	169	176-16	199	200-1KT	218,219,230	220-1	238	240-29	187	276-1	261
168-3A	193	176-26	199	200-2	218,221	220-2	238	240-36	181	277-1	261,262,265
168-4	193	176-27	199	200-3	221	220-3	239	240-39	180	277-3	262,268
168-4A	193	176-31	199	200-3KT	222	221-1	218,219,221,230	240-40	179-181	278-1	261
168-5	193	176-32	198	200-4	219,220	221-1L	218,219,221,230	240-41	178,180,185	278-2	261
168-6	193	176-33	198	200-6	221,222	221-3	219,228	240-61	177,178	278-4	261,262
168-7	193	176-34	198	200-7	219-227	221-36	225-227,231	240-85	180,181	278-10	262,268
168-16	193	176-35	199	200-8	220-228	221-37	225-227	241-1	269	280-1	261
168-17	193	176-36	199	200-9	222,223,226,228	221-38	225-227	242-1	269	280-2	262,268
168-19A	193	176-38	199	200-61	219-227	221-61	219	243-1	269	281-1	261
168-22	193	177-1	201	200-62	221,223,228	221-62	219-231	244-1	269	281-5	262,268
168-23	193	177-2	201	200-62KT	221,223,228	221-63	224,230	245-2	255,256,257,258,259,260,268	282-4	267
168-24	193	177-3	201	200-63	221,223,228,231	221-64	224,228,230	246-2	255,256,257,258,259	284-1	263,264
168-50	193	177-4	201	200-63KT	223,228	221-65	224,227-229	246-2	255,256,257,258,259	284-1A	264
168-51	193	177-5	201	200-64	231	221-66	224,227-229	246-6255,256,257,258,259,268	243,244	284-1B	264
169-4	193	177-6	201	200-65KT	227	221-68	223,226,227,231	248-1	243,244	284-1C	264
169-5	193	177-11	201	200-66	222	221-69	227,228	249-1	243	285-1	263
169-6	193	177-12	201	200-66KT	230	221-70	227-229	249-2	243,244	285-7	253,267
169-11	193	177-45	201	200-67	224,228,230	221-71	223,226,227,231	250-1	243	286-1	263,264
169-15	191	177-46	201	200-68	224,228,229,231	221-72	227,229,231	250-2	243	292-1	255-259,265,268
169-16	191	177-47	201	200-69	227,229	221-73	230	250-5	243,244	292-2	256-260
169-17	191	177-51	201	200-70	227-229	221-75	230	251-1	243,244,265,266	293-1	255-259
169-19	193	177-52	201	200-71	226,227	221-76	231	251-2	249,250,251	293-3	255-259,268
170-1	196	177-53	201	200-72	227,231	221-91	218	252-1	243,265	294-1	255,256,257
170-3	196	180-4	208	200-73	230	221-93	218	252-2	243,244,265,266	294-2	255,256
170-4	196	181-1	210	200-73KT	230	221-94	218	253-1	269	296-4	232
171-1	197	181-2	210	200-75	230	221-95L	224	254-1	269	296-7	232
171-3	197	181-3	210	200-75KT	230	221-96L	229	255-1	245	296-10	232
172-1	194	181-4	210	200-76	231	221-97L	229	255-2	245,246,247,248	300-1	280
172-2	194	181-7	210	200-251	218	221-226	218	255-3	249,250	301-1	275,276
172-3	194	181-8	210	200-252	230	221-227	218	255-4	250	301-2	276

Les références des pièces sont indicatives.
Nos pièces ne sont pas d'origine

Part numbers are quoted for reference purposes only.
Our parts and accessories are not original.



"THE RELIABLE SERVICE"



INDEX DES REFERENCES
REFERENCE INDEX

Réf. Ref.	Page Page	Réf. Ref.	Page Page	Réf. Ref.	Page Page	Réf. Ref.	Page Page	Réf. Ref.	Page Page	Réf. Ref.	Page Page	Réf. Ref.	Page Page
301-6	279	341-8	363	355-12	361	376-11	290	411-18	311	422-47	302		
302-1	261-268,275-277	341-23	283	356-1	362	376-14	296	411-23	313	422-48	305		
303-1	275,276	341-24	363	356-2	362	376-15	291	411-40	313	422-49	305		
303-12	279	341-25	363	357-1	286	376-16	293	411-41	313	422-50	305		
303-16	276,277	341-26	363	357-2	286,287	376-17	293	411-42	313	422-51	305		
303-17	276	342-1	283-284	357-4	288,289	376-18	293	411-43	313	422-52	305		
303-17A	276	343-1	283-284	357-5	288	376-19	293	411-44	313	422-53	303		
303-18	276	346-1	298	357-6	288	376-20	293,294	411-45	313	422-54	303,304		
303-19	276	346-10	283-284	357-7	288	376-21	293,294	411-46	312	422-55	304		
303-20	275	347-2	285	357-8	289	376-22	296	411-47	312	422-56	304		
303-36	277	348-1	285	357-9	289	376-23	296,298	411-48	313	422-57	304		
303-37	277	348-2	285	357-10	289	376-24	296	412-10	301	422-58	304		
303-44	278	349-1	285	358-1	286	376-25	298	413-1	311	423-1	302		
303-45	278	349-2	285	358-2	288,290	376-26	298	413-2	311	423-13	302		
303-46	278	349-3	285	358-6	288,289	376-27	298	413-3	311	423-20	302		
303-62	278	349-5	285	358-7	289	376-28	298	413-4	311	423-21	302		
303-64	278	350-1	285	358-8	289	378-2	295,298	413-10	313	423-22	302		
303-76	275	350-2	285	370-4	291,292	378-3	295,298	413-22	313	423-23	305		
303-77	279	351-1	285	370-10	295,298	379-1	299	413-24	313	423-24	305		
303-82	279	352-1	286	370-11	295,298	380-1	299	413-40	313	423-25	305		
303-90	275	352-2	286,287	371-1	290	381-1	299	413-43	312	424-1	307		
303-91	277	352-3	286,287	371-2	291	381-2	299	413-44	312	424-2	307		
303-92	278	352-11	288,295,298	371-3	291,292	381-3	299	413-45	312	424-5	307		
303-93	278	352-12	361	371-3S	291,292	383-1	299	414-1	311	425-1	307		
303-94	278	352-13	288, 361	371-19	290	384-1	299	414-2	311	425-2	307		
303-101	278	352-14	361	371-28	295,298	385-1	299	414-3	311,312	426-1	307		
304-1	275,276	352-15	288, 362	371-29	295,298	387-9	296	414-40	313	426-2	307		
304-2	276,278	352-16	288, 362	371-30	290	387-10	296	414-41	313	426-7	307		
304-3	276,277	352-17	362	371-31	293	393-1	280	414-42	313	430-1	308		
304-18	279	352-18	287	371-32	293	400-1	300	414-43	311	430-6	308		
304-19	279	352-19	287	371-33	293	403-1	300	414-44	313	431-1	308		
305-1	275,276	352-20	287	371-34	293,294	404-1	300	415-1	311,312	432-1	306		
305-3	275	352-21	288	371-35	293	405-1	300	415-2	311,312	432-2	306		
305-7	276,278	352-22	288	371-36	293	406-1	300	416-16	303	433-2	306		
305-8	276,278	352-23	289,323	371-37	293	407-1	300	416-17	303,304	436-1	317		
305-21	279,298	352-24	289,296	371-39	294	408-1	300	416-18	303	436-2	317		
305-22	276,277	353-1	286,287	371-40	295	409-1	309	416-19	303,304	436-3	317		
305-23	278	353-5	362	371-41	295,298	409-2	309	416-20	304	437-1	317		
305-24	278	353-6	362	371-42	295,298	409-3	309	416-21	304	437-2	317		
306-1	275,276	353-7	358,361, 362	372-1	292	409-4	309	416-22	304	438-1	317		
306-2	255-260,276	353-11	289, 296,298,361	372-3	291,292	409-5	309	416-23	304	438-2	317		
306-6	255-260	353-12	288, 361, 362	372-4	291,292	409-6	309	416-24	304	439-1	316		
306-8	279	353-13	361	372-24	291,292,293	409-7	309	416-25	303	439-2	316		
308-2	276,277	353-14	296,298,362	372-25	295,298	409-8	309	416-26	303,304	440-1	314		
308-4	275,276	353-15	362	372-26	295,298	409-25	309	417-1	301	440-3	314		
310-1	269	353-16	362	372-27	295,298	409-26	309	417-2	302	440-12	314		
310-5	280	353-17	362	372-28	296,298	409-27	309	417-29	301	440-32	314		
311-1	269	353-20	286,287	372-29	296,298	409-28	309	417-30	302	440-33	314,320		
311-2	280	353-21	287	372-35	290	409-30	309	417-31	301	440-34	319,320		
312-1	269	353-22	287	372-36	290	409-31	309	417-35	301	440-35	314		
312-2	280	353-23	287	372-37	290	409-32	309	417-36	302	440-36	314		
314-1	265	353-24	288,289	372-38	292	409-33	310	417-37	302	440-37	314		
315-1	265	353-25	288	372-39	293	409-34	310	417-38	302	440-38	314,320		
316-1	280	353-26	288	372-40	293	409-35	310	417-39	302	440-39	319,320		
316-5	269	353-27	289	372-41	293	409-36	310	417-40	302	440-40	319,320		
316-6	280	354-1	286,287, 361	372-42	293,294	409-37	310	417-41	302	440-41	319		
317-1	265,280	354-2	286	372-43	293,294	409-38	310	417-42	302	440-42	319		
317-7	269	354-3	286	372-44	293	409-39	310	417-43	305	440-43	320		
317-8	280	354-6	362	372-45	293	409-40	310	417-44	305	440-44	320		
318-3	280	354-7	358,361	372-46	293,294	409-41	310	417-45	305	440-45	320		
321-1	280	354-8	362	372-47	294	409-42	310	418-1	301,302,305	441-1	314,315,316		
322-1	269	354-9	362	372-48	294	409-43	310	418-6	301	441-2	314,320		
325-1	281	354-16	288,295,298	372-49	294	409-44	310	418-7	302,305	441-3	314,316		
329-1	281	354-18	296,298,361	372-50	295	409-45	310	418-8	305	441-12	314		
330-1	281	354-19	361	372-51	295,298	410-1	311	419-1	301,302	441-27	319		
330-2	281	354-20	362	372-52	295,298	410-2	311,313	419-2	301,302	441-32	314		
330-3	281	354-21	287,361,362	372-53	295	410-3	311	419-7	302	441-33	314,319,320		
330-4	281	354-22	362	372-54	295,296,298	410-4	311	419-8	302,305	441-35	314-320		
330-6	281	354-23	362	372-55	295,296	410-5	311	419-9	305	441-37	314		
331-1	281	354-24	362	372-56	296	410-6	311	420-1	301	441-38	320		
332-1	282	354-25	286,287	372-57	296	410-7	312	420-26	301	441-39	320		
332-2	282	354-26	286,287	372-58	296	410-18	311	420-27	301	442-1	315		
333-1	282	354-27	287	372-59	296	410-27	313	420-28	301	442-6	318		
333-2	282	354-28	287	372-61	298	410-28	313	420-31	304	442-10	315		
334-1	282,389	354-29	287	372-63	298	410-29	313	421-1	301	442-11	315		
336-1	282	354-30	287	372-65	298	410-43	313	421-8	301	442-12	315,316		
336-2	282	354-31	287	372-66	298	410-44	313	421-9	301	442-13	315,316		
336-3	282	354-32	288	372-67	298	410-45	313	422-1	302	442-14	315		
337-1	269	354-33	289	372-69	298	410-46	312	422-7	303	442-15	315		
339-1	283-284	355-1	362	372-70	298	410-47	312	422-8	303	442-16	316		
340-1	283	355-5	361	375-1	290	411-1	311,313	422-20	303,304	442-17	316		
340-3	283	355-6	362	375-3	290	411-3	311	422-21	304	442-18	316		
340-4	283	355-7	361	376-1	290	411-4	311	422-29	302	442-19	316,318		
341-1	283	355-8	362	376-2	291	411-5	311	422-44	302	442-20	318		
341-3	283	355-9	362	376-3	291,292	411-6	311	422-45	302	442-21	318		
341-4	283	355-10	362	376-4	291,292	411-7	312	422-46	302	442-22	316		

Les références des pièces sont indicatives.
Nos pièces ne sont pas d'origine

Part numbers are quoted for reference purposes only.
Our parts and accessories are not original.



INDEX DES REFERENCES
REFERENCE INDEX

Réf. Ref.	Page Page	Réf. Ref.	Page Page	Réf. Ref.	Page Page	Réf. Ref.	Page Page	Réf. Ref.	Page Page	Réf. Ref.	Page Page
443-1	315	470-37	329	485-41	331,332	495-246	341,344	551-11	273	580-1	338,339,370
443-6	315,316	470-38	329	485-42	332	495-247	341,344	551-12	273	580-2	338,339,370
443-7	315	470-40	327,328	485-43	332	497-1	337,338	551-15	272,274	580-3	370
443-8	316	470-43	328	485-44	332	497-3	337,338	551-16	274	580-3A	370
443-9	316	470-44	325	485-45	331	497-5	337-340	551-17	273	580-8	370
443-10	316	470-45	325	485-46	331,332	497-16	341-344	551-20	274	581-1	336,338,339
443-12	318	471-1	325	486-1	330	497-17	341-344	552-1	272	581-2	337-339
443-13	316	471-2	325	486-2	330	497-18	341,342	552-4	272	581-26	336,340
446-1	319	471-3	325	486-3	330,331,332	497-19	341-343	552-6	272	585-1	338,339,371
446-2	319	471-4	325,334	486-4	330,331	497-20	341	552-7	272	585-2	371
446-3	319	471-5	325,326,334	486-5	331,332,352	497-26	336,339	552-8	272	585-3	371
446-12	320	471-6	325	486-6	331,332,333	497-27	341,342	552-9	272	585-4	371
446-30	319	471-7	326	486-40	330	497-29	337,339	553-2	272	585-5	356,371,372
446-31	320	471-8	326	486-41	352	497-30	337,338	553-3	272	585-9	356
446-32	320	471-9	326,327,334	486-43	353	497-105	341-343	553-4	272	585-10	356
447-1	319	471-10	326,327	486-44	353	497-191	341,344	553-9	272	585-11	356
449-2	321	471-23	334	486-45	353	498-1	336,338	554-2	274	585-12	356
449-3	321	471-24	326,327	486-46	353	498-2	336,338	555-1	270,271	585-13	356
449-4	321	471-25	327	486-48	352	498-3	336,338	556-1	270,271	585-14	356
449-16	321	471-40	327,328	486-49	352	498-4	337-339	556-2	270	585-15	356
449-17	321	471-44	325	486-51	353	498-5	336,338-340	556-3	270	585-16	356
450-1	322	471-45	325	486-52	353	499-3	344	556-9	274	585-18	371
450-2	322	473-1	322	486-53	353	499-4	344	556-10	274	585-19	371
450-3	322	473-5	322	486-55	353	499-5	344	556-11	274	585-20	371
450-4	322	475-1	325,334	486-56	353	499-6	344	557-1	270,271	585-21	371
450-11	322	475-2	325	486-57	353	499-7	344	560-1	379	585-22	371
451-1	322	475-3	325,326,327,334	486-58	353	499-8	344	560-2	379	585-23	371
451-2	322	475-23	334	486-62	331,332	499-9	344	560-2D	379	585-24	372
452-1	322	475-26	325	486-63	331,332	499-10	344	560-16	379	585-25	372
452-2	322	475-27	326,327,328	487-1	331,332,345-348	500-2	346	560-29	379	585-26	372
452-16	322	475-28	327,328	487-4	330,331	501-1	345	560-30	379	585-27	372
453-1	322	475-29	327,328	488-2	331,488	501-2	346-348	560-31	379	586-1	370
454-1	322	475-30	327	488-4	330,331	502-1	346,348	560-32	379	590-012	383
454-2	322	475-31	328	489-1	333	502-1A	346	560-33	379	592-012	383
454-3	322	475-32	326,328	489-2	333	503-1	346-348	561-1	379	600-1	374
454-7	322	475-33	328	489-3	333	504-1	345-348	561-3	379	600-2	374
457-2	322	475-34	328	489-4	333	505-1	345	565-1	368	600-3	374
457-8	322	475-35	325	490-3	337,338,340	505-2	346,348	565-2	368	600-4	374
460-1	323	476-1	325,334	490-5	337,338	505-3	345,347,348	565-9	368	600-5	374
460-2	323,334	476-2	325-328,334	491-1	336,338	505-4	346,348	565-48	368	600-6	374
460-3	323,334	476-15	327,328,334	491-2	336,338,340	506-1	345,346	565-52	368	601-1	375
460-4	323	476-16	327,328	491-3	336,338,340	506-2	345-348	565-75	369	601-2	376-378
460-5	323	476-17	328	491-12	336,338	510-1	349	565-106	369	602-1	375
460-24	334	477-1	325,334	491-19	336,338	510-2	349	565-107	369	602-2	376-378
460-37	323	477-2	325	491-29	336,338	510-4	349	565-111	369	603-1	375-378
460-38	323	477-3	325-328,334	491-30	336,338	511-2	349	565-226	369	604-1	375-378
460-39	323	477-18	327,328,334	491-31	337,338	511-4	349	565-229	369	605-1	375
460-40	323	477-19	325	491-32	336,338	512-1	349	565-230	369	605-1A	375
461-1	323	477-20	325	492-1	336,338,340	514-5	349	566-5	368	605-2	376
461-2	323,334	477-39	329	492-2	336,338-342	514-14	349	566-6	368	605-2A	376
461-3	323,334	477-50	327,328	492-12	336,338	515-1	349	566-60	368	605-3	378
461-4	323	477-51	326,328	492-25	337,338	515-2	349	566-61	368	605-3A	378
461-24	334	477-52	328	492-27	337,338	516-1	349	566-113	368	605-4	377
461-47	323	477-53	329	494-1	356	517-1	349	566-222	368	605-4A	377
461-51	323,328	479-1	325,334	494-2	356	520-1	350	569-1	176-179,180	606-1	375,376
461-52	323	479-2	325-327,334	494-3	356	521-1	350	570-1	367	606-2	377
461-53	323	479-18	334	495-1	336,338	525-1	350	570-1B	367	606-3	378
462-1	323	479-41	329	495-2	336,338	526-1	350	570-1E	367	606-4	375-378
462-2	323,334	479-43	326-328	495-6	336,338	528-5	350	570-2	367	607-1	375,376
462-3	323,334	479-44	326,327,328	495-7	336,338	529-1	350	570-5	367	607-2	377
462-24	334	479-45	327,328	495-8	336,338-340	530-1	350	570-6	367	607-3	378
462-37	323	479-46	328	495-8S	336	530-2	350	570-7	367	608-1	375
462-51	323	479-47	328	495-32	337,339,340	530-5	350	570-8	367	608-2	376
462-53	323	479-48	329	495-33	336,339,340	530-6	350	570-9	367	608-3	378
463-1	323	480-19	329	495-34	336,339,341-343	530-14	350	570-11	367	608-4	377
463-2	323,334	480-20	329	495-35	336,339, 341	531-1	350	570-14	367	609-1	375-378
463-3	323,334	481-1	330	495-36	336,340	532-1	350	573-1	366	610-1	374
463-24	334	481-2	330,331,332	495-37	341-343	533-2	350	574-1	174-177,188	610-1A	374
463-37	323	481-3	330,331	495-38	341,343	535-4	350	574-2	175,177,188	611-1	376,377
463-53	323	482-1	324	495-40	341-343	535-8	350	574-3	173,175,188	611-2	377,378
468-1	324	482-2	324	495-41	341-343	536-1	351	574-4	175-177,188	614-1	376-378
468-2	324	483-1	324	495-50	337,339,340	536-2	351	574-7	178,180	614-2	376-378
469-1	324	483-2	324	495-58	339,340	537-1	351	574-14	177,186,187	615-1	375
470-1	325	483-4	324	495-61	341,343,344	537-2	351	574-21	175,177	615-2	376
470-2	325	484-1	324	495-62	341-344	541-1	351	574-25	182-185	615-3	377
470-3	325	484-2	324	495-63	341,343,344	541-2	351	575-1	367	615-5	378
470-4	325,334	485-1	330	495-64	341,343,344	543-1	351	575-2	367	615-7	378
470-5	325,326,334	485-2	330	495-65	341,343,344	543-2	351	575-3	367	616-1	375-378
470-6	325	485-3	330,331	495-66	341,343,344	544-1	351	575-4	367	617-1	375-377
470-7	326	485-4	331	495-69	342,343	544-2	351	575-6	367	617-2	378
470-8	326	485-5	330,331,332	495-71	336,339	545-1	351	575-16	367	618-1	375-378
470-9	326,327,334	485-14	331,332	495-120	341-343	545-2	351	576-1	370	620-1	374
470-10	326,327	485-15	330	495-121	341,343	546-1	351	577-1	370	620-2	374
470-23	334	485-28	330	495-167	336,340	547-1	351	578-1	370	620-3	374
470-24	326,327	485-30	333	495-177	339	550-1	351	578-2	370	620-4	374
470-25	327	485-40	331,332	495-178	339	551-1	273	579-1	370	621-1	375

Les références des pièces sont indicatives.
Nos pièces ne sont pas d'origine

Part numbers are quoted for reference purposes only.
Our parts and accessories are not original.



"THE RELIABLE SERVICE"



INDEX DES REFERENCES
REFERENCE INDEX

Réf. Ref.	Page Page	Réf. Ref.	Page Page	Réf. Ref.	Page Page	Réf. Ref.	Page Page	Réf. Ref.	Page Page	Réf. Ref.	Page Page
621-2	376	690-5	386	716-5	390	761-46	398	851-2	438	872-43	430
621-5	376,377	690-6	386	720-1	390	761-47	397,398	851-3	438	872-51	430
621-6	378	691-4	386	720-2	390	761-48	397	851-4	438	875-1	240
625-1	173,174	691-5	386	720-6	390	761-50	397	851-5	438	908-3	373
625-2	174-177	691-10	386	721-2	390	761-51	398	851-6	438	908-4	373
625-4	176,177,179,180	692-1	386	729-1	392	762-1	395	851-7	438	908-5	373
625-5	178	692-2	386	729-2	392	762-2	395	851-8	438	909-4	373
625-6	178,180	692-3	386	730-1	393	762-3	395	851-9	438	909-5	373
625-7	178-180	692-17	386	730-2	393	762-4	397	853-1	438	910-1	399,406,410
625-9	179,180	692-18	386	730-3	393	762-5	397	853-2	438	911-2	410
625-11	183,184	692-19	386	730-4	393	762-6	397	853-3	438	912-1	410
625-14	175,176,179,180	692-20	386	730-6	393	762-11	397	853-4	438	912-2	410
626-3	379	692-40	386	730-7	393	762-40	397	853-5	438	913-1	410
627-6	189	692-41	386	730-8	393	762-42	398	853-6	438	913-2	410
640-10	369	692-43	386	734-1	392	762-43	398	853-7	438	914-1	410
640-10B	369	693-3	386	735-1	392	762-46	398	853-8	438	915-1	410
640-29	368	693-4	386	735-2	392	762-48	398	853-9	438	919-1	410
640-30	368	693-10	386	735-5	392	762-49	398	860-1	427	919-2	410
640-31	368	695-1	386	735-6	392	763-1	396	860-2	427	919-3	409
640-47	369	695-2	386	740-5	394	765-1	396	860-3	427	919-4	410
640-48	369	696-1	386	740-6	394	765-4	396	860-4	427	919-5	410
640-52	369	696-2	386	740-28	393	766-1	396	860-5	427	919-9	409
640-53	369	697-1	386	740-33K	392	766-2	396	860-6	428	919-17	409
641-3	188	697-2	386	740-34K	392	767-1	396	860-7	428	919-19	409
641-26	182-185	699-1	386	740-35K	392	767-6	396	860-8	428	919-21	409
641-27	180,181	700-1	388	740-37	394	768-1	396	860-9	428	919-33	409
645-2	380	700-2	388	740-38	393	769-1	396	860-10	428	919-35	409
648-5	380	700-4	388	740-39	394	774-2	390	860-12	428	919-43	409
648-6	380	700-5	388	740-42	394	774-3	390	860-17	428	919-44	409
648-7	380	700-6	388	740-43	394	774-4	390	860-18	428	919-80	409
648-8	380	700-7	388	740-44	393	774-5	390	860-19	428	919-81	409
649-1	380	700-8	388	740-45	393	791-1	389	860-20	428	919-82	409
649-2	380	700-9	388	740-46	393	791-2	389	860-21	428	919-83	409
649-5	380	700-10	388	741-3	318	791-3	389	860-22	428	919-84	409
650-2	379	700-23	388	743-6	394	830-611	429	860-24	428	919-85	409
650-3	379	700-24	388	744-4	394	830-980	429	860-106	428	919-86	409
650-4	379	700-32	388	746-3	394	830-981	429	860-107	428	919-87	409
655-1	174,175,177,188	700-33	388	747-2	394	831-1	429	860-108	428	919-88	409
655-2	174,175	700-34	388	750-1	392	831-29	429	860-109	428	919-89	409
655-3	174-177,187,188	700-35	388	757-1	396	831-30	429	860-111	428	919-90	409
655-4	174-177,188	700-36	388	757-2	396	831-31	429	860-112	428	919-91	409
655-5	188	700-37	388	758-1	396	831-32	429	860-113	428	919-92	409
658-1	383	700-38	388	758-2	396	831-33	429	860-114	428	919-93	409
659-1	383	700-39	388	758-3	394	832-1	429	860-115	428	919-94	409
661-1	383	701-1	388	758-19	398	832-5	429	860-116	428	919-95	409
661-2	383	701-2	388	758-20	398	832-6	429	860-117	428	919-96	409
661-3	383	701-3	388	759-1	395	838-4	424	860-118	428	919-97	409
665-1	383	701-13	388	759-2	395	839-5	424	860-119	428	919-98	409
666-1	383	702-1	388	759-3	395	839-6	424	860-120	428	919-99	409
668-1	383	702-2	388	759-4	395	840-1	426	860-121	428	920-1	409
670-1	383	702-3	388	759-7	397	840-2	426	860-122	428	920-2	409
670-2	383	702-4	388	759-8	397	840-3	426	860-123	428	920-3	409
671-1	384	702-11	388	759-9	397	840-4	424,426	860-124	428	920-4	409
672-1	384	702-12	388	759-14	397	841-1	424,426	860-125	428	920-5	409
673-1	384	702-13	388	759-34	398	841-2	426	860-126	428	920-6	409
674-1	384	702-14	388	759-51	398	841-3	424,426	860-127	428	920-7	409
674-2	384	703-1	388	760-1	395	841-4	426	861-4	427	920-8	409
676-1	384	703-2	388	760-2	395	841-5	426	861-6	427	920-9	409
676-2	384	703-3	388	760-3	395	842-1	424,426	861-9	427	920-10	409
676-3	384	703-13	388	760-4	395	842-2	426	861-10	427	920-11	409
677-1	384	704-1	389	760-5	395	842-3	424,426	861-11	427	920-12	409
682-1	385	704-2	389	760-6	395	843-1	424	863-1	427	920-13	409
682-4	385	704-3	389	760-7	395	843-1H	424	863-2	427	920-14	409
682-10	385	710-1	389	760-11	397	843-5	424,426	863-13	428	920-15	409
684-1	385	710-2	389	760-12	397	844-1	424	865-1	427	920-16	409
684-2	385	710-3	389	760-13	397	844-2	424	867-3	427	920-17	409
684-3	385	710-4	389	760-14	397	844-10	425	867-4	427	920-18	409
684-10	385	710-10	389	760-15	397	844-11	425	867-6	427	920-19	409
684-11	385	712-2	391	760-21	397	844-12	425	867-7	427	920-20	409
685-1	385	712-4	391	760-22	397	844-13	425	867-8	427	920-21	409
685-2	385	712-5	391	760-40	398	844-14	425	868-1	427	920-22	409
685-8	385	712-6	391	760-41	398	844-15	425	870-1	430	920-23	409
685-12	385	712-7	391	760-42	398	844-16	425	870-2	430	920-24	409
686-1	385	712-8	391	760-44	398	844-17	425	870-3	430	920-25	409
686-3	385	712-9	391	760-45	398	844-22K	424	870-4	430	920-26	409
686-3A	385	712-10	391	760-60	398	844-23K	424	870-53	430	920-27	409
686-10	385	712-11	391	760-61	398	844-26	424	870-63	430	920-28	409
686-11	385	712-12	391	760-62	398	844-27	424	870-64	430	920-29	409
686-12	385	712-13	391	761-1	395	844-28	424	870-74	430	920-30	409
686-13	385	712-14	391	761-2	395	844-29	424	871-1	430	920-31	409
687-1	385	712-26	391	761-3	395	847-1	436	871-3	430	920-32	409
687-2	385	712-27	391	761-7	397	847-3	436	871-26	430	920-33	409
687-7	385	713-3	390	761-8	397	850-1	438	871-39	430	920-34	409
689-1	385	713-4	390	761-9	397	850-3	438	872-1	430	920-35	409
689-5	385	714-3	390	761-12	397	850-4	438	872-2	430	920-36	409
690-4	386	714-4	390	761-36	397	851-1	438	872-3	430	920-37	409

Les références des pièces sont indicatives.
Nos pièces ne sont pas d'origine

Part numbers are quoted for reference purposes only.
Our parts and accessories are not original.



INDEX DES REFERENCES
REFERENCE INDEX

Réf. Ref.	Page Page	Réf. Ref.	Page Page	Réf. Ref.	Page Page	Réf. Ref.	Page Page	Réf. Ref.	Page Page	Réf. Ref.	Page Page
933-2	423	970-2	204	1918-88	213	2930-114	172	4000-56	455	4051-2T	447
933-3	423	973-2	204	1918-89	213	2930-127	172	4000-70	454	4052-1	450,451
934-1	423	975-1	209	1918-111	212	2930-152	172	4000-70T	454	4053-1	450,451
939-3	422	975-2	209	1918-113	212	2935-45	172	4000-71	454	4054-1	450
939-5	422	975-5	209	1919-35	212	2935-48	172	4000-72T	454	4054-2	451
939-7	422	976-1	209	1919-36	212	2935-51	172	4000-73T	454	4054-3	452
939-8	422	976-2	209	1919-38	212	2935-54	172	4000-74T	454	4055-1	449-451
939-12	422	976-3	209	1919-39	212	2935-58	172	4000-78	440	4056-1	449-451
939-13	422	976-4	209	1919-40	212,213	2935-70	172	4000-90	455	4057-1	449-452
939-15	422	976-5	209	1919-65	213	2935-79	172	4001-1T	446	4057-2	451
939-16	422	979-1	209	1919-66	213	2935-92	172	4001-5	446	4058-1	451
940-1	421	979-2	209	1919-74	212	2940-012	154	4001-9	441	4059-1	452
940-4	421	980-1	93	1919-111	212	2940-022	154	4010-4	444,445	4069-3	454
940-5	421	981-1	93	1919-112	212	2940-025	154	4011-4	444,445	4069-3T	454
940-6	421	982-1	93	1920-7	215	2940-030	154	4012-11	443	4069-4	454
940-9	421	983-1	93	1920-8	215	2940-035	154	4012-11T	443	4069-4T	454
940-12	421	984-1	93	1931-13	216	2940-040	154	4012-12	442	4069-7	455
940-14	421	1563-1	437	1931-14	216	2940-050	154	4012-12T	442	4069-8	455
940-36	421	1563-2	437	1931-16	216	2940-055	154	4012-13	446	4070-2	449-452
950-1	203	1563-3	437	1931-17	216	2940-060	154	4012-14	448	4071-22	455
950-2	203	1881-6	209	1931-28	216	2940-070	154	4012-15	453	4071-23	455
950-36	203	1884-47	204	1931-29	216	2940-080	154	4012-37	454	4071-29	441
951-2	203	1884-48	204	1931-33	216	2940-090	154	4012-37T	454	4072-3	442,443
953-1	203	1884-49	204	1932-17	216	2940-100	154	4012-40	454	4072-3T	442,443
953-11	203	1884-50	204	1940-19	216	2940-120	154	4012-40T	454	4072-4	445
953-13	203	1884-51	204	1943-16	216	2940-140	154	4012-49	454	4072-5	444
953-14	203	1884-52	204	1955-209	212	2940-160	154	4012-49T	454	4072-6	446
954-1	203	1884-53	204	1955-239	212,214	3102-200	431	4012-50	454	4072-6T	446
954-4	204	1912-10	214	1955-245	212-215	3102-201	431	4012-50T	454	4072-7	448
954-5	204	1912-11	214	1955-380	213-215	3102-202	431	4012-52	441	4072-8	448
956-1	203	1912-14	214	1955-382	212-215	3102-203	431	4012-53	440	4072-9	453
956-10	203	1912-15	214	1955-410	210,211	3102-204	431	4014-1T	446	4072-9A	453
956-11	203	1912-112	214	1955-453	216	3102-205	431	4014-4	449-452	4072-44	454
957-1	203	1912-113	214	1955-472	211	3102-206	431	4014-6	455	4072-44T	454
958-5	202	1912-116	214	1980-6	434	3102-207	431	4014-7	455	4072-81	440
958-9	202	1912-117	214	1980-7	434	3102-208	431	4020-8	448	4073-3	444,445
958-10	202	1912-118	215	1980-17	434	3102-209	431	4020-9	449	4073-4	446
958-11	202	1912-119	215	1980-18	434	3102-210	431	4021-8	443	4073-4T	446
958-32	202	1912-120	215	1980-19	434	3102-211	431	4021-8T	443	4073-5	448
958-33	202	1912-121	214	1980-22	434	3102-212	431	4021-9	443	4073-6	453
958-34	202	1912-122	214	1980-23	434	3102-213	431	4021-9T	443	4073-27	454
958-35	202	1912-123	215	1980-43	434	3102-214	431	4021-10	442	4073-172	442
958-36	202	1912-132	214	1980-44	434	3102-215	431	4021-10T	442	4073-172T	442
958-37	202	1912-133	214	1987-9	435	3102-216	431	4021-11	442	4074-9	440
958-38	202	1912-136	215	1987-11	435	3102-217	431	4021-11T	442	4075-9	440
958-47	202	1912-137	215	1987-12	435	3102-218	431	4021-39	441	4080-3	442,443
960-1	204	1912-138	215	1987-16	435	3102-219	431	4021-40	440	4080-3T	442,443
961-1	209	1912-140	214	1987-18	435	3102-220	431	4022-8	443	4080-4	447
961-10	209	1912-145	213	1987-20	435	3102-221	431	4022-8T	443	4090-1	437
961-11	209	1912-146	214	1987-22	435	3102-222	431	4022-9	442	4090-2	437
962-1	207	1912-147	214	1987-31	435	3102-223	431	4022-10	444,445	4090-5	437
962-3	207	1912-148	215	1987-38	435	3102-224	431	4022-11	445	4110-9	439,446,447
962-9	207	1912-149	215	1987-41	435	3102-225	431	4022-11A	444	4110-10	439
962-10	207	1912-150	215	1987-42	435	3102-226	431	4022-12	449	4110-11	439
964-14	209	1912-151	215	1987-43	435	3102-227	431	4022-39	441	4110-12	439,442-453
964-15	209	1912-152	215	1987-44	435	3102-228	431	4022-40	440	4110-13	439
967-22	205	1912-153	215	1987-45	435	3102-229	431	4026-1	453	4111-4	439,446,447
967-23	206	1913-12	214	1988-2	434	3102-230	431	4027-1	453	4112-2	439
967-24	206	1913-13	214	1988-3	434	3102-231	431	4038-2	455	4112-3	439
967-25	206	1913-110	214	2070-250	324	3102-233	431	4038-9	454	4112-4	439,448,453-455
967-26	206	1913-111	214	2070-300	324	3102-234	431	4038-9T	454	4112-5	439
967-27	206	1913-112	215	2070-350	324	3102-235	431	4039-2	455	4114-14	439
967-28	206	1913-113	214,215	2070-550	324	3102-236	431	4039-9	454	4114-15	439
967-29	206	1913-114	215	2070-700	324	3102-237	431	4039-9T	454	4170-14	436
967-30	206	1913-118	214	2070-800	324	3102-238	431	4047-4	442,443	4170-15	436
967-31	206	1913-132	214	2309-1	344	3102-239	431	4047-4T	442,443	4170-18	436,437
967-32	206	1913-145	213	2309-2	344	3102-240	431	4047-5	442,443	4170-30	436
967-33	206	1913-152	215	2309-3	344	3102-241	431	4047-5T	442,443	4170-31	436
967-34	206	1913-153	215	2309-4	344	3102-242	431	4047-6	444,445	4170-51	437
967-35	206	1918-56	212	2309-5	344	3102-243	431	4047-6A	444,445	4170-52	437
967-36	206	1918-57	212	2309-6	344	3102-244	431	4047-7	448	4170-53	437
967-37	206	1918-59	212	2309-7	344	3102-245	431	4047-8	453	4170-55	436
967-38	206	1918-60	212	2309-8	344	3102-246	431	4047-57	441	4170-56	436
967-39	206	1918-61	212	2410-1	31	3102-247	431	4047-58	440	4170-57	436
967-40	206	1918-63	212	2930-35	172	4000-15	443	4048-1	447	4170-58	436
967-41	206	1918-64	212	2930-38	172	4000-15T	443	4048-1T	447	4170-59	437
967-52	205	1918-65	213	2930-45	172	4000-16	442	4048-2	449,450,452	4170-60	437
967-53	205	1918-66	213	2930-51	172	4000-16T	442	4049-1	446	4170-61	437
967-54	205	1918-68	213	2930-57	172	4000-17	444	4049-1T	446	4170-62	437
967-55	205	1918-69	212	2930-64	172	4000-18	445	4050-1	447	4170-87	436
967-56	205	1918-73	212	2930-70	172	4000-19	446	4050-1T	447	4170-88	436
967-57	205	1918-74	212	2930-76	172	4000-20	448	4050-2	447	4170-89	436
967-58	205	1918-75	212	2930-89	172	4000-21	449-452	4050-2T	447	4170-90	436
967-59	205	1918-76	213	2930-95	172	4000-23	453	4051-1	447	4177-1	437
967-60	205	1918-77	213	2930-102	172	4000-41	444	4051-1T	447	4200-25	192
967-61	206	1918-87	213	2930-108	172	4000-43	446	4051-2	447	4200-28	192

Les références des pièces sont indicatives.
Nos pièces ne sont pas d'origine

Part numbers are quoted for reference purposes only.
Our parts and accessories are not original.



"THE RELIABLE SERVICE"



INDEX DES REFERENCES REFERENCE INDEX

Réf. Ref.	Page Page	Réf. Ref.	Page Page	Réf. Ref.	Page Page	Réf. Ref.	Page Page	Réf. Ref.	Page Page	Réf. Ref.	Page Page
4200-30	192	6408-1	359	6452-18	358	9604-102	91				
4200-31	192	6408-2	297,359	6452-19	358	9604-103	91				
4200-32	192	6408-3	297,359	6452-20	358	9604-110	91				
4200-33	192	6408-4	297,360	6462-1	297,357	9604-113	91				
4200-34	192	6408-5	297,360	6462-13	357	9604-121	91				
4200-35	192	6408-6	359	6462-14	357	9604-130	92, 279				
4200-36	192	6408-31	360	6462-15	297,357	9604-139	92				
4200-39	192	6408-32	359	6462-16	297,357	9604-140	92				
6051-1	78,81	6408-33	359	6462-17	357	9604-143	92				
6051-2	78,80,81	6408-34	359	6462-18	357	9604-150	92				
6052-1	78-81	6408-35	359	6462-46	297	9604-221	92				
6093-1	105	6409-1	357	6489-5	352						
6099-6	121	6409-2	357	6489-6	352						
6099-7	121	6409-3	357	6489-7	352						
6099-8	121	6409-4	357	6489-8	353						
6121-1	105	6409-5	357	6489-9	353						
6250-1K	265	6409-6	357	6489-10	353						
6250-2K	265	6409-7	357	6489-11	353						
6283-3	266	6410-1	297,360	6489-13	353						
6283-4	267	6410-2	297,360	6489-14	353						
6283-5	268	6410-3	297,359	6489-15	352						
6283-6	268	6410-4	297,359	6492-1	364						
6284-2	266,267	6410-5	297,360	6492-2	364						
6284-3	266	6410-6	360	6492-3	364						
6284-4	266,267	6410-20	358	6492-6	364						
6284-5	268	6410-34	293,359	6492-7	365						
6284-6	268	6410-35	359	6492-8	365						
6284-7	268	6411-1	357	6492-9	364						
6284-8	268	6412-1	357	6500-17	370						
6284-9	268	6412-2	357	6618-2	380						
6284-10	268	6412-3	357	6618-3	380						
6284-11	268	6412-4	357	6637-2	380						
6285-1	267	6416-1	356	6637-3	380						
6285-2	267	6416-2	356	6637-4	380						
6285-3	267	6417-1	359	6641-2	387						
6285-4	268	6417-5	359	6677-5	387						
6285-5	268	6418-2	364	6677-6	387						
6286-1	267	6418-5	364	6678-17	387						
6286-2	267	6418-6	365	6678-18	389						
6286-3	267	6418-7	364	6678-19	387						
6287-1	266	6420-1	358	6679-16	387						
6288-1	266	6421-1	361	6679-17	387						
6289-1	266	6423-1	365	6679-18	387						
6290-1	267	6423-2	365	6679-21	387						
6291-1	267,268	6427-1	365	6682-16	387						
6292-1	267	6427-2	365	6682-17	387						
6292-2	268	6430-1	360	6682-18	387						
6293-1	267,268	6431-1	360	6683-16	279						
6294-1	267,268	6432-2	360	6689-1	93						
6295-1	267	6433-1	360	6690-1	93						
6295-2	268	6433-2	360	6691-1	93						
6296-1	267,268	6440-1	366	6691-4	93						
6297-1	267,268	6440-2	361	6691-5	93						
6298-1	267,268	6440-3	361	7600-22	381						
6299-1	268	6441-1	361	7600-24	381						
6310-1	264	6441-2	361	7600-25	381						
6311-1	264	6442-1	361	7601-5	381						
6312-1	264	6443-1	361	7601-7	381						
6313-1	264	6443-2	361	7601-8	381						
6314-1	264	6444-1	366	7602-4	381						
6315-1	264	6444-2	361	7608-3	382						
6340-1	363	6444-3	361	7611-6	381						
6341-1	363	6444-3	361, 362	7611-7	382						
6403-1	354	6444-4	361	7611-8	382						
6403-2	354	6444-5	362	7611-9	382						
6403-3	354	6450-7	358	7611-11	382						
6403-4	354	6450-8	358	7615-7	381						
6403-5	354,365	6450-9	358	7615-9	381						
6403-21	355	6450-16	358	7700-3	306						
6403-22	354	6450-17	358	7700-4	306						
6403-49	365	6450-20	358	7703-5K	306						
6403-52	354	6450-21	358	7703-6K	306						
6403-53	355	6450-22	358	9156-26	130						
6403-55	355	6451-15	358	9156-27	130						
6403-56	354,355	6451-16	358	9156-28	130						
6403-57	355	6451-17	358	9156-29	130						
6403-58	355	6451-18	358	9156-32	130						
6403-59	355	6451-19	358	9197-2	116						
6407-1	357,361	6451-21	358	9198-11	116						
6407-2	357	6452-11	358	9198-13	116						
6407-3	357	6452-12	358	9198-15	116						
6407-4	297,357,361	6452-13	358	9198-16	116						
6407-18	297,357	6452-14	358	9198-23	116						
6407-43	297	6452-15	358	9198-24	116						
6407-44	297	6452-16	358	9198-33	116						
6407-45	297	6452-17	358	9604-101	91						

Les références des pièces sont indicatives.
Nos pièces ne sont pas d'origine

Part numbers are quoted for reference purposes only.
Our parts and accessories are not original.



**BEPCO PARTS SA****HERMALLE-SOUS-HUY**

Rue Chaumont, 4D • 4480 Hermalle-sous-Huy • Belgique
T +32 85 24 54 00 • F +32 85 24 54 50
info.be@bepcoparts.com • www.bepcoparts.com

VILLERS-LE-BOUILLET

Rue de Waremme, 114 • 4530 Villers-le-Bouillet • Belgique
T +32 85 24 54 00 • F +32 85 24 54 50
info.be@bepcoparts.com • www.bepcoparts.com

**BEPCO UK LTD**

Bepco House • Unit 316 • Hartlebury Trading Estate
Hartlebury - Worcestershire, DY10 4JB (UK)
P +44 (0)1299 252270 • F 0800 216553
info@bepcoparts.com • www.bepcoparts.com

**BEPCO FRANCE SAS**

Z.I. La Plaine, Allée de Bigorre
BP80041 Le Passage • 47901 Agen Cedex 9 • France
T +33 (0)553 96 31 25 • F +33 (0)553 68 03 72
info.fr@bepcoparts.com • www.bepcoparts.com

VILLENEUVE-SUR-LOT

294 Av. de Bordeaux • CS 30059 Bias
FR-47302 Villeneuve sur lot • France
T +33 (0)5 53 40 37 50 • F +33 (0)5 53 70 61 93

JANZÉ

P.A. de la Chauvelière • Rue Charles Lindbergh
35150 JANZE • France
T + 33 (0)2 99 44 16 18 • F +33 (0)2 99 44 17 29

**TVH AUSTRALASIA PTY LTD**

HEAD OFFICE BRISBANE • www.bepcoparts.com

ADELAIDE

96 South Terrace • Wingfield SA 5013
Free 1800 182 344 • T +61 8 8359 8933 • F +61 8 8234 2212
BepcoSAsales@tvh.com.au

BRISBANE

735 Boundary Road • Richlands QLD 4077
Free 1800 020 082 • T +61 7 3344 1113 • F +61 7 3344 1332
BepcoQLDsales@tvh.com.au

MELBOURNE

7/66-74 Micro Circuit • Dandenong South VIC 3175
Free 1800 802 367 • T +61 3 9796 5422 • F +61 3 9796 5251
BepcoVICsales@tvh.com.au

PERTH

2/15 Colin Jamieson Drive • Welshpool WA 6106
Free 1800 182 344 • T +61 8 8352 8984 • F +61 8 8234 2212
BepcoWAsales@tvh.com.au

SYDNEY

1/1002-1010 Canley Vale Rd • Wetherill Park NSW 2164
Free 1800 808 827 • T +61 2 6885 5288 • F +61 3 9796 5251
BepcoNSWsales@tvh.com.au

**TVH NEW ZEALAND LTD****AUCKLAND**

PO Box 51490 • Pakuranga 2140 • 11K Echelon Place
East Tamaki • Auckland
Free 0800 459 662 • T +64 9 274 9695 • F +64 9 274 9698
info@tvh.co.nz • www.tvh.com

CHRISTCHURCH

11C Parkhouse Road
Wigram • Christchurch 8042
Free 0508 8 722 867 • T +64 3 550 1298 • F +64 3 974 9993
infochch@tvh.co.nz

**BEPCO DEUTSCHLAND GmbH**

Neuer Weg 5 • 59505 Bad Sassendorf • Germany
T +49 (0)2927 919 59 0 • F +49 (0)2927 919 59 59
info.de@bepcoparts.com • www.bepcoparts.com

**BEPCO NEDERLAND BV**

Den Dolvert 10 • 5473 GP, Heeswijk-Dinther • Nederland
T +31 (0)413 29 39 75 • F +31 (0)413 29 40 87
info.nl@bepcoparts.com • www.bepcoparts.com

**BEPCO IBÉRICA SA**

C/ Torrent de Vallmajor, 82
08915 Badalona (Barcelona) • Spain
T +34 (0)902 111 062 - 933 810 062 • F +34 (0)933 813 345
info.es@bepcoparts.com • www.bepcoparts.com

ALMENDRALEJO

Ctra. Badajoz - Pol. «Rayvaz» Nave 21
06200 Almendralejo (Badajoz)
T +34 (0)902 111 062 - 924 664 890
F +34 (0)924 664 576

DOS HERMANAS

Pol. Ind. La Isla, C/ Hornos, 11
41703 Dos Hermanas (Sevilla)
T +34 (0)902 111 062 - 954 931 546
F +34 (0)954 930 130

SANTIAGO DE COMPOSTELA

Pol. El Tambre, Via Faraday, 36
15890 Santiago de Compostela
T +34 (0)902 111 062 - 981 560 012
F +34 (0)981 557 753

**TVH PARTS SOUTH AFRICA (Pty) Ltd**

HEAD OFFICE JOHANNESBURG • www.tvh.com

CAPE TOWN

1 Karee Street • Kraaifontein Industries • Cape Town 7571
T +27 21 988 2432 • F +27 21 988 9127
capetownsales@tvh.com

DURBAN

2 Monaco Place • Westmead • Pinetown 3600
T +27 31 100 0760 • F +27 31 700 6191
durbansales@tvh.com

JOHANNESBURG

90 Electron Avenue • Isando • Kempton Park 1601
T +27 11 281 27 00 • F +011 974 9845
johannesburgsales@tvh.com

LICHTENBURG

Shop 1 • 109 Scholtz Street • Lichtenburg 2740
T +27 18 632 6192/6092 • F +27 18 632 6108
lichtenburgsales@tvh.com

PORT ELIZABETH

134 Kempston Road • Korsten • Port Elizabeth 6020
T +27 41 453 1404/8 • F +27 41 453 1409
portelizabethsales@tvh.com

FOR ALL OUR LATEST CATALOGUE UPDATES AND COMPANY INFO: WWW.BEPCOPARTS.COM



The spare parts mentioned in this list can normally be delivered from stock. In addition, we can supply parts, which are not mentioned in this catalogue, with the shortest possible delivery time. The O.E.M. references are only for indication purposes and do not imply that the spare parts are coming from the manufacturer. This spare parts list can be modified without prior notice. All photographs, drawings, illustrations, brand names, descriptions and numbers are included for identification purposes only.



De onderdelen vermeld in deze lijst, zijn normaal uit voorraad leverbaar, behoudens uitverkocht. Ook niet-vermelde onderdelen kunnen binnen de kortste tijd uitgeleverd worden. De O.E.M. referenties dienen enkel ter indicatie en impliceren niet dat deze van de vermelde constructeur afkomstig zijn. Deze onderdelenlijst kan zonder enige voorafgaande verwittiging aangepast worden. Alle gebruikte foto's, tekeningen, afbeeldingen, merknamen, omschrijvingen en nummers dienen alleen ter identificatie.



Les pièces de rechange, mentionnées dans cette liste, sont normalement livrables du stock. En plus, les articles non indiqués peuvent être fournis en peu de temps. Cette liste peut être modifiée sans avis préalable. Les références O.E.M. sont seulement indicatives et n'impliquent pas que les pièces de rechange viennent du constructeur. Toutes les photographies, illustrations, marques, descriptions, tous les plans et numéros servent exclusivement à une identification.



Die in dieser Liste aufgeführten Teile sind normalerweise aus dem Lager lieferbar. Wir sind zudem in der Lage nicht aufgeführte Teile innerhalb kürzester Zeit zu liefern. Die O.E.M. Referenznummern dienen zur Information und beinhalten nicht, dass diese vom genannten Hersteller kommen. Diese Bestandsliste kann ohne vorhergehende Ankündigung geändert werden. Alle verwendeten Foto's, Zeichnungen, Abbildungen, Markennamen, Beschreibungen und Nummern dienen nur zu Identifikationszwecken.



Los artículos mencionados en este catálogo se encuentran habitualmente en stock. Además, podemos suministrar en un plazo corto de tiempo otros artículos relacionados que no se encuentren expresamente mencionados en este catálogo. Las referencias O.E.M. sirven sólo como indicación y no implican que procedan del constructor. Este listado de productos puede estar sujeto a modificaciones sin aviso previo. Todas las fotos, dibujos, ilustraciones, nombres de marca, descripciones y números se han incluido simplemente con el propósito de su identificación.



I pezzi di ricambio, menzionati in questo listino, possono essere forniti con una consegna immediata a condizione che non siano esauriti. I pezzi di ricambio non menzionati possono essere forniti in poco tempo. Le referenze O.E.M. sono solamente indicative e non implicano che i pezzi di ricambio vengano da questo costruttore. Questa lista ricambi può essere aggiustata senza avvisi anticipati. Tutti i numeri, codici, nomi, foto, spaccati e disegni sono solo a titolo informativo.



Części z tego katalogu są zazwyczaj na stanie magazynowym. Również części które nie są wyszczególnione w katalogu mogą być dostarczone na zamówienie w najkrótszym możliwym terminie. Opis części O.E.M. jest używany informacyjnie i nie wskazuje na to, że dany produkt jest wyprodukowany przez podanego producenta. Zawartość katalogu może ulec zmianie bez wcześniejszego informowania o tym. Wszystkie użyte zdjęcia, rysunki, nazwy marek, opis i numery służą tylko do identyfikacji.



Запчасти из настоящего списка, как правило, имеются в запасе, если только он не распродан. Прочие, не фигурирующие в списке артикулы, могут быть поставлены в самые кратчайшие сроки. Указание оригинальных номеров производителя не предполагает обязательного оригинального происхождения самих деталей. Данный список может изменяться без предварительного уведомления. Все использованные фото, рисунки, иллюстрации, названия брендов, наименования и номера служат исключительно для цели идентификации.

Visitez notre site :
www.bepcoparts.com

© **bepco 2016**

Tous droits réservés. Aucune partie de ce catalogue ne peut, ni intégralement, ni partiellement être reproduite ou communiquée (copiée, sauvegardée, utilisée dans un système de sauvegarde de données, etc) sous n'importe quelle forme, soit numérique ou mécanique, sans accord préalable et explicite de la société BEPCO PARTS.

- BEPCO est un fournisseur de pièces de rechange et accessoires d'après-vente qui sont appropriés pour l'entretien et la réparation des équipements OEM. Les Références OEM et marques sont à titre purement indicatif et ne signifient pas que les accessoires et/ou pièces de rechange viennent du fabricant de l'équipement ou des pièces d'origine.
- Les produits qui ne sont pas conformes aux exigences réglementaires concernant la conformité de la CE ne sont pas mis sur le marché dans l'Espace économique européen.
- BEPCO® est une marque déposée.
- Toutes les ventes sont soumises aux termes et conditions générales de vente sur www.bepcoparts.com
- Les photographies et les illustrations sont inclus à titre de référence seulement. Sous réserve d'erreurs d'impression.

Visit us on the Internet:
www.bepcoparts.com

© **bepco** 2016

All rights reserved. No part of this catalogue may be reproduced or communicated in any form or by any means, electronic or mechanical, including copying, recording or use in an information storage or retrieval system, without prior and explicit permission of BEPCO PARTS.

- BEPCO is a supplier of after-market spare parts and accessories that are suitable for the maintenance and repair of OEM-equipment. OEM references and brands are purely indicative and do not imply that the accessories and/or spare parts are coming from the original equipment or parts manufacturer.
- Products that do not comply with regulatory requirements concerning CE conformity are not placed on the market in the European Economic Area.
- BEPCO® are registered trademarks.
- All sales are subject to the general terms & conditions of sale on www.bepcoparts.com
- Photographs and illustrations are included for reference purposes only. Printing errors reserved.

Pièces détachées
de A à Z
toutes marques

Spare parts
from A-Z for
all brands

Massey Ferguson

Case IH
David Brown
Fendt
Fiat
Ford
Hürlimann
JCB
John Deere
K.H.D. (Deutz)
Kubota
Landini
Lamborghini
Manitou

Mc Cormick
Merlo
New Holland
Renault
Same
Steyr
Valmet
Zetor

moving forward in every field

REF. 90/999-41



HEAD OFFICE

Rue Chaumont 4D • 4480 Hermalle-sous-Huy • Belgium
T +32 (0)85 24 54 00 • F +32 (0)800 23 132 • info.be@bepcoparts.com • www.bepcoparts.com

Member of **TVH** 